

300mA ULTRA LOW DROPOUT POSITIVE ADJUSTABLE AND FIXED REGULATORS

FEATURES

- SOT-23 Package
- Stable with 2.2µF Ceramic Capacitor
- 1% Voltage Reference Accuracy
- Only 270mV Dropout at 300mA and 170mV Dropout at 150mA
- 5µA Quiescent Current in Shutdown
- Current Limit and Thermal Shutdown
- Logic Input Enable Pin

DESCRIPTION

The IRU1205 device is an efficient linear voltage regulator with better than 1% initial voltage accuracy, very low dropout voltage and very low ground current designed especially for hand held, battery powered applications. Other features of the device are: TTL compatible enable/shutdown control input, current limiting and thermal shutdown.

The IRU1205 is available in fixed and adjustable output voltage versions in a small SOT-23 5-Pin package.

APPLICATIONS

- Laptop, Notebook & Palmtop computers
- Battery Powered Equipments
- PCMCIA Vcc & Vpp Regulator
- Consumer Electronics
- High Efficiency Linear Power Supplies

TYPICAL APPLICATION

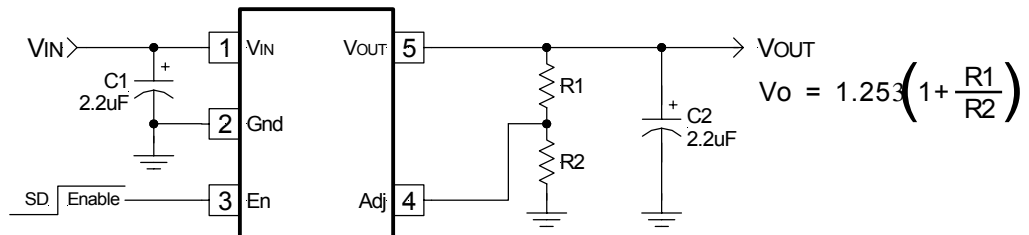

Figure 1 - Typical application of the IRU1205 adjustable voltage regulator.

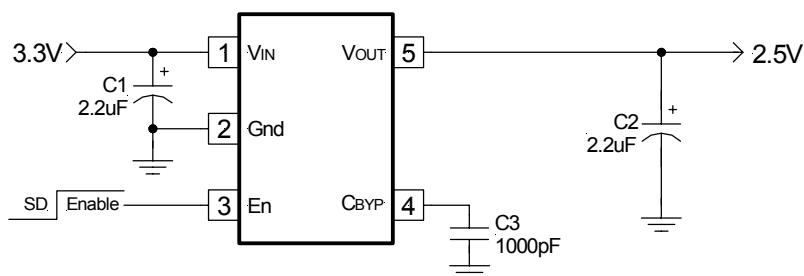

Figure 2 - Typical application of the IRU1205-25 fixed voltage regulator.

PACKAGE ORDER INFORMATION

Basic Part (Non-Lead Free)

T _J (°C)	5-PIN SOT-23 (L5)	SOT-23 MARKING	OUTPUT VOLTAGE
0 To 125	IRU1205CL	AT00	Adj
0 To 125	IRU1205-18CL	AT18	1.8V
0 To 125	IRU1205-25CL	AT25	2.5V
0 To 125	IRU1205-28CL	AT28	2.8V
0 To 125	IRU1205-30CL	AT30	3.0V
0 To 125	IRU1205-33CL	AT33	3.3V
0 To 125	IRU1205-36CL	AT36	3.6V

Leadfree Part

T _J (°C)	5-PIN SOT-23 (L5)	SOT-23 MARKING	OUTPUT VOLTAGE
0 To 125	IRU1205CLPbF	AT00	Adj
0 To 125	IRU1205-18CLPbF	AT18	1.8V
0 To 125	IRU1205-25CL PbF	AT25	2.5V
0 To 125	IRU1205-28CLPbF	AT28	2.8V
0 To 125	IRU1205-30CLPbF	AT30	3.0V
0 To 125	IRU1205-33CLPbF	AT33	3.3V
0 To 125	IRU1205-36CLPbF	AT36	3.6V

ABSOLUTE MAXIMUM RATINGS

Input Voltage (V_{IN})	10V
Enable Input Voltage	10V
Storage Temperature Range	-65°C To 150°C
Operating Junction Temperature Range	0°C To 150°C

PACKAGE INFORMATION

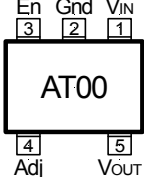
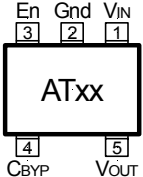
5-PIN SOT-23 (L5)	5-PIN SOT-23 (L5)
 <p>Adjustable $U_{JA}=2568C/W$</p>	 <p>Fixed $U_{JA}=2568C/W$</p>

ELECTRICAL SPECIFICATIONS

Unless otherwise specified, these specifications apply over $C_{IN}=C_{O}=22\mu F$, $I_{O}=100\mu A$, $V_{IN(MIN)}=2.5V$ (Adjustable devices) $V_{IN}=V_{O} + 1V$ (for fixed voltage devices), $V_{OUT}=V_{FB}$ (for adjustable version only), $C_{BYP}=470pF$ (for AT18, AT25, AT28, AT30, AT33 and AT36), $V_{ENB}=2V$ and $T_{A}=25^{\circ}C$. Typical values refer to $T_{A}=25^{\circ}C$. Low duty cycle pulse testing is used which keeps junction and case temperatures equal to the ambient temperature.

PARAMETER	SYM	TEST CONDITION	MIN	TYP	MAX	UNITS
Reference Voltage (See Table 1 for typical values)	V_{O}	(Note 4)	-1 -2		1 2	%
Line Regulation	ΔV_{I}	$V_{O} + 1V < V_{IN} < 10V$		0.005		%/V
Load Regulation (Note 1)	ΔV_{L}	$1mA < I_{O} < 100mA$ $100mA < I_{O} < 300mA$		0.8 0.1		%
Dropout Voltage (Note 2)	$\Delta V_{I(O)}$	$I_{O}=100\mu A$ $I_{O}=100\mu A$ (Note 4) $I_{O}=50mA$ $I_{O}=50mA$ (Note 4) $I_{O}=150mA$ $I_{O}=150mA$ (Note 4) $I_{O}=300mA$ $I_{O}=300mA$ (Note 4)		10 13 85 100 170 204 270 324	50 70 110 140 220 260 350 400	mV
Ground Current (Note 3)	I_{Q}	$V_{EN}=2V$, $I_{O}=100\mu A$ $I_{O}=100\mu A$ (Note 4) $I_{O}=50mA$ $I_{O}=50mA$ (Note 4) $I_{O}=150mA$ $I_{O}=150mA$ (Note 4) $I_{O}=300mA$ $I_{O}=300mA$ (Note 4)		120 240 420 540 2200 2900 7200 9300	160 600 2900 9500	μA
Ground Current-SD Activated	$I_{Q(SD)}$	$V_{EN}=0V$ to 0.8V or Open		5		μA
Current Limit	I_{CL}	$V_{O}=0V$	320	420		mA
Thermal Regulation	ΔV_{P}	$V_{IN}=10V$, $I_{O}=150mA$, 10ms Pulse		0.05		%/W
Adjust Pin Current	I_{ADJ}	$V_{IN}=2.5V$, $V_{O}=V_{ADJ}$		0.1		μA
Enable Pin Input LO Voltage	$V_{EN(L)}$	Regulator OFF			0.8	V
Enable Pin Input HI Voltage	$V_{EN(H)}$	Regulator ON	2			V
Enable Pin Input LO Current		$V_{EN(L)}=0V$ to 0.8V		0.01		μA
Enable Pin Input HI Current		$V_{EN(H)}=2V$ to V_{IN}		20		μA

Note 1: Low duty cycle pulse testing with Kelvin connections is required in order to maintain accurate data.

Note 2: Dropout voltage is defined as the minimum differential voltage between V_{IN} and V_{OUT} required to maintain regulation at V_{OUT} . It is measured when the output voltage drops 1% below its nominal value.

Note 3: Ground current is the regulator quiescent current plus the pass transistor current. The total current from the supply is the sum of the load current plus the ground pin current.

Note 4: The specification applies for the junction temperature of 0 to +125°C.

PIN DESCRIPTIONS

PIN #	PIN SYMBOL	PIN DESCRIPTION
1	V_{IN}	The input pin of the regulator. Typically a large storage capacitor is connected from this pin to ground to insure that the input voltage does not sag below the minimum drop out voltage during the load transient response. This pin must always be higher than V_{OUT} by at least the amount of the dropout voltage and some margin in order for the device to regulate properly.
2	Gnd	Ground pin. This pin must be connected to the lowest potential in the system and all other pins must be at higher potential with respect to this pin.
3	En	Enable pin. A low signal or left open on this pin shuts down the output. This pin must be tied HI or to V_{IN} for normal operation.
4	Adj (Adjustable Only)	A resistor divider from this pin to the V_{OUT} pin and ground sets the output voltage. To minimize the error due to the error amplifier, select the values of the resistor dividers to be less than 10K Ω .
4	C_{BYP} (Fixed Only)	A 470 to 1000pF bypass capacitor connected to this pin reduces the output noise.
5	V_{OUT}	The output of the regulator. A minimum of 2.2 μ F with max ESR of 1 Ω capacitor must be connected from this pin to ground to insure stability.

5-PIN SOT-23	Output Voltage
IRU1205	1.25V
IRU1205-18	1.8V
IRU1205-25	2.5V
IRU1205-28	2.8V
IRU1205-30	3.0V
IRU1205-33	3.3V
IRU1205-36	3.6V

Table 1- Nominal output voltage vs. part number.

The output voltage of the adjustable device can be set using:

$$V_o = 1.25 \times \left(1 + \frac{R_1}{R_2} \right)$$

Where:

R1 = Resistor connected from output to the Adj pin

R2 = Resistor connected from Adj pin to Gnd

BLOCK DIAGRAM

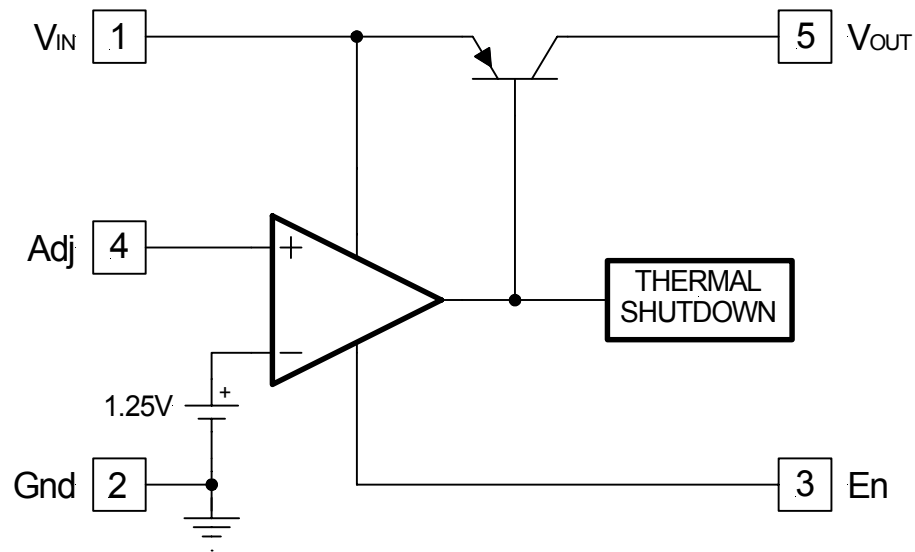

Figure 3 - IRU1205 Adjustable output block diagram.

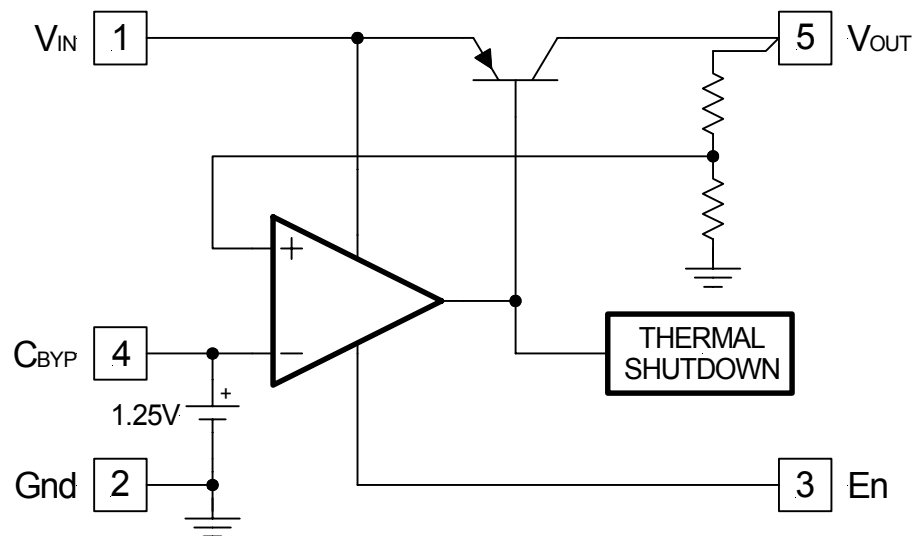
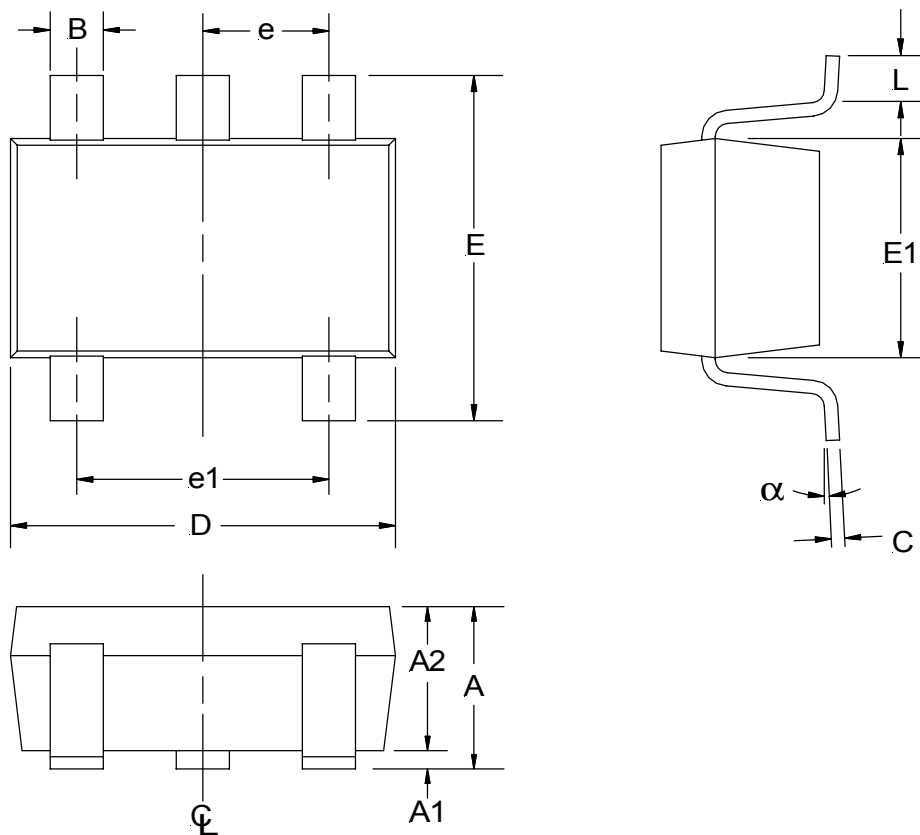

Figure 4 - IRU1205-18, IRU1205-25, IRU1205-28, IRU1205-30, IRU1205-33 and IRU1205-36 Fixed output block diagram.

(L5) SOT-23 Package
 5-Pin



SYMBOL	MIN	MAX
A	0.90	1.45
A1	0.00	0.15
A2	0.90	1.30
B	0.25	0.50
C	0.09	0.20
D	2.80	3.00
E	2.60	3.00
E1	1.50	1.75
e	0.95 REF	
e1	1.90 REF	
L	0.35	0.55
α	0°	10°

NOTE: ALL MEASUREMENTS
 ARE IN MILLIMETERS.

PACKAGE SHIPMENT METHOD

PKG DESIG	PACKAGE DESCRIPTION	PIN COUNT	PARTS PER TUBE	PARTS PER REEL	T & R Orientation
L5	SOT-23	5	—	3000	Fig A

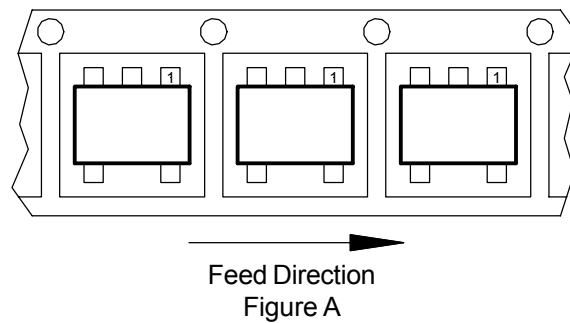

Looking for pricing, stock, or lifecycle information?

Click below to explore more details on WIN SOURCE:

 [View IRU1205-36CLTR on WIN SOURCE](#)

 [Infineon Technologies](#) Information

Optimize Your Supply Chain with WIN SOURCE Solutions

-  Global Sourcing Solution
-  Obsolete Management
-  Cost Control Management
-  Shortage Management
-  Alternative Solution
-  Excess Inventory Management