



**THE DATASHEET OF  
ISL9005IRFZ-T**



**NOT RECOMMENDED FOR NEW DESIGNS**  
**RECOMMENDED REPLACEMENT PART**  
**ISL9005A**

## ISL9005

LDO with Low ISUPPLY, High PSRR

FN9234  
 Rev 2.00  
 May 5, 2008

ISL9005 is a high performance Low Dropout linear regulator capable of sourcing 300mA current. It has a low standby current and high-PSRR and is stable with output capacitance of 1 $\mu$ F to 10 $\mu$ F with ESR of up to 200m $\Omega$ .

The ISL9005 has a high PSRR of 75dB and output noise less than 45 $\mu$ V<sub>RMS</sub>. When coupled with a no load quiescent current of 50 $\mu$ A (typical), and 0.1 $\mu$ A shutdown current, the ISL9005 is an ideal choice for portable wireless equipment.

Several different fixed voltage outputs are standard. Output voltage options for each LDO range are from 1.5V to 3.3V. Other output voltage options may be available upon request.

### Pinout

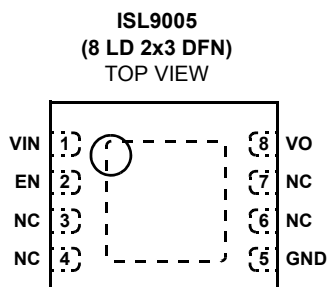

### Features

- 300mA high performance LDO
- Excellent transient response to large current steps
- Excellent load regulation: <0.1% voltage change across full range of load current
- High PSRR: 75dB @ 1kHz
- Wide input voltage capability: 2.3V to 6.5V
- Very low quiescent current: 50 $\mu$ A
- Low dropout voltage: typically 200mV @ 300mA
- Low output noise: typically 45 $\mu$ V<sub>RMS</sub> @ 100 $\mu$ A (1.5V)
- Stable with 1 $\mu$ F to 10 $\mu$ F ceramic capacitors
- Soft-start to limit input current surge during enable
- Current limit and overheat protection
- $\pm$ 1.8% accuracy over all operating conditions
- Tiny 2mmx3mm 8 Ld DFN package
- -40°C to +85°C operating temperature range
- Pb-free (RoHS compliant)

### Applications

- PDAs, cell phones and smart phones
- Portable instruments, MP3 players
- Handheld devices including medical handhelds

### Ordering Information

PART NUMBER (Notes 1, 2)	PART MARKING	VO VOLTAGE (V) (Note 3)	TEMP RANGE (°C)	PACKAGE Tape and Reel (Pb-Free)	PKG. DWG. #
ISL9005IRNZ-T	ETA	3.3V	-40 to +85	8 Ld 2x3 DFN	L8.2x3
ISL9005IRMZ-T	ESA	3.0V	-40 to +85	8 Ld 2x3 DFN	L8.2x3
ISL9005IRLZ-T	ERA	2.9V	-40 to +85	8 Ld 2x3 DFN	L8.2x3
ISL9005IRKZ-T	EPA	2.85V	-40 to +85	8 Ld 2x3 DFN	L8.2x3
ISL9005IRJZ-T	ENA	2.8V	-40 to +85	8 Ld 2x3 DFN	L8.2x3
ISL9005IRRZ-T	EVA	2.6V	-40 to +85	8 Ld 2x3 DFN	L8.2x3
ISL9005IRFZ-T	EMA	2.5V	-40 to +85	8 Ld 2x3 DFN	L8.2x3
ISL9005IRCZ-T	ELA	1.8V	-40 to +85	8 Ld 2x3 DFN	L8.2x3
ISL9005IRBZ-T	EKA	1.5V	-40 to +85	8 Ld 2x3 DFN	L8.2x3

#### NOTES:

1. These Intersil Pb-free plastic packaged products employ special Pb-free material sets; molding compounds/die attach materials and 100% matte tin plate PLUS ANNEAL - e3 termination finish, which is RoHS compliant and compatible with both SnPb and Pb-free soldering operations. Intersil Pb-free products are MSL classified at Pb-free peak reflow temperatures that meet or exceed the Pb-free requirements of IPC/JEDEC J STD-020.
2. Please refer to TB347 for details on reel specifications.
3. For other output voltages, contact Intersil Marketing.

**Absolute Maximum Ratings**

Supply Voltage (VIN) .....	+7.1V
VO Pin .....	+3.6V
All Other Pins .....	-0.3 to (VIN + 0.3)V

**Recommended Operating Conditions**

Ambient Temperature Range (TA) .....	-40°C to +85°C
Supply Voltage (VIN) .....	2.3V to 6.5V

**Thermal Information**

Thermal Resistance (Notes 4, 5)	$\theta_{JA}$ (°C/W)	$\theta_{JC}$ (°C/W)
8 Ld 2x3 DFN Package .....	69	10
Junction Temperature Range .....	-40°C to +125°C	
Operating Temperature Range .....	-40°C to +85°C	
Storage Temperature Range .....	-65°C to +150°C	
Pb-free reflow profile .....	see link below <a href="http://www.intersil.com/pbfree/Pb-FreeReflow.asp">http://www.intersil.com/pbfree/Pb-FreeReflow.asp</a>	

**CAUTION:** Do not operate at or near the maximum ratings listed for extended periods of time. Exposure to such conditions may adversely impact product reliability and result in failures not covered by warranty.

**NOTES:**

- $\theta_{JA}$  is measured in free air with the component mounted on a high effective thermal conductivity test board with "direct attach" features. See Tech Brief TB379.
- For  $\theta_{JC}$ , the "case temp" location is the center of the exposed metal pad on the package underside.

**Electrical Specifications**

Unless otherwise noted, all parameters are guaranteed over the operational supply voltage and temperature range of the device as follows:  $T_A = -40^\circ\text{C}$  to  $+85^\circ\text{C}$ ;  $V_{IN} = (V_O + 0.5\text{V})$  to 5.5V with a minimum  $V_{IN}$  of 2.3V;  $C_{IN} = 1\mu\text{F}$ ;  $C_O = 1\mu\text{F}$ .

PARAMETER	SYMBOL	TEST CONDITIONS	MIN (Note 8)	TYP	MAX (Note 8)	UNITS
<b>DC CHARACTERISTICS</b>						
Supply Voltage	$V_{IN}$		2.3		6.5	V
Ground Current		Quiescent condition: $I_O = 0\mu\text{A}$				
	$I_{DD}$	LDO active		50	75	$\mu\text{A}$
Shutdown Current	$I_{DDS}$	LDO disabled @ +25°C		0.1	1.0	$\mu\text{A}$
UVLO Threshold	$V_{UV+}$		1.9	2.1	2.3	V
	$V_{UV-}$		1.6	1.8	2.0	V
Regulation Voltage Accuracy		Initial accuracy at $V_{IN} = V_O + 0.5\text{V}$ , $I_O = 10\text{mA}$ , $T_J = +25^\circ\text{C}$	-0.7		+0.7	%
		$V_{IN} = V_O + 0.5\text{V}$ to 5.5V, $I_O = 10\mu\text{A}$ to 300mA, $T_J = +25^\circ\text{C}$	-0.8		+0.8	%
		$V_{IN} = V_O + 0.5\text{V}$ to 5.5V, $I_O = 10\mu\text{A}$ to 300mA, $T_J = -40^\circ\text{C}$ to +125°C	-1.8		+1.8	%
Maximum Output Current	$I_{MAX}$	Continuous	300			mA
Internal Current Limit	$I_{LIM}$		350	475	600	mA
Dropout Voltage (Note 7)	$V_{DO1}$	$I_O = 300\text{mA}$ ; $V_O < 2.5\text{V}$		300	500	mV
	$V_{DO2}$	$I_O = 300\text{mA}$ ; $2.5\text{V} \leq V_O \leq 2.8\text{V}$		250	400	mV
	$V_{DO3}$	$I_O = 300\text{mA}$ ; $V_O > 2.8\text{V}$		200	325	mV
Thermal Shutdown Temperature	$T_{SD+}$			145		°C
	$T_{SD-}$			110		°C
<b>AC CHARACTERISTICS</b>						
Ripple Rejection (Note 6)		$I_O = 10\text{mA}$ , $V_{IN} = 2.8\text{V}$ (min), $V_O = 1.8\text{V}$				
		@ 1kHz		75		dB
		@ 10kHz		60		dB
		@ 100kHz		40		dB
Output Noise Voltage (Note 6)		$I_O = 100\mu\text{A}$ , $V_O = 1.5\text{V}$ , $T_A = +25^\circ\text{C}$ BW = 10Hz to 100kHz		45		$\mu\text{V}_{RMS}$

**Electrical Specifications** Unless otherwise noted, all parameters are guaranteed over the operational supply voltage and temperature range of the device as follows:  $T_A = -40^{\circ}\text{C}$  to  $+85^{\circ}\text{C}$ ;  $V_{IN} = (V_O + 0.5\text{V})$  to  $5.5\text{V}$  with a minimum  $V_{IN}$  of  $2.3\text{V}$ ;  $C_{IN} = 1\mu\text{F}$ ;  $C_O = 1\mu\text{F}$ . **(Continued)**

PARAMETER	SYMBOL	TEST CONDITIONS	MIN (Note 8)	TYP	MAX (Note 8)	UNITS
<b>DEVICE START-UP CHARACTERISTICS</b>						
Device Enable Time	$t_{EN}$	Time from assertion of the ENx pin to when the output voltage reaches 95% of the $V_O$ (nom)		250	500	$\mu\text{s}$
LDO Soft-start Ramp Rate	$t_{SSR}$	Slope of linear portion of LDO output voltage ramp during start-up		30	60	$\mu\text{s}/\text{V}$
<b>EN PIN CHARACTERISTICS</b>						
Input Low Voltage	$V_{IL}$		-0.3		0.5	V
Input High Voltage	$V_{IH}$		1.4		$V_{IN} + 0.3$	V
Input Leakage Current	$I_{IL}, I_{IH}$				0.1	$\mu\text{A}$
Pin Capacitance	$C_{PIN}$	Informative		5		pF

## NOTES:

6. Limits established by characterization and are not production tested.
7.  $V_{Ox} = 0.98 \cdot V_{Ox(NOM)}$ ; Valid for  $V_{Ox}$  greater than  $1.85\text{V}$ .
8. Parts are 100% tested at  $+25^{\circ}\text{C}$ . Temperature limits established by characterization and are not production tested.

### Typical Performance Curves

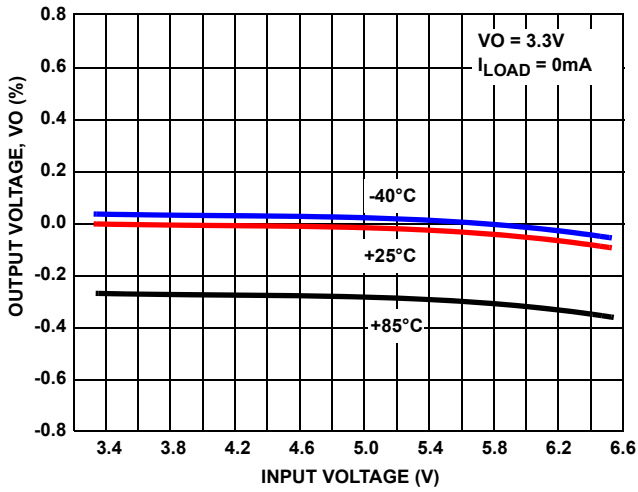

FIGURE 1. OUTPUT VOLTAGE vs INPUT VOLTAGE (3.3V OUTPUT)

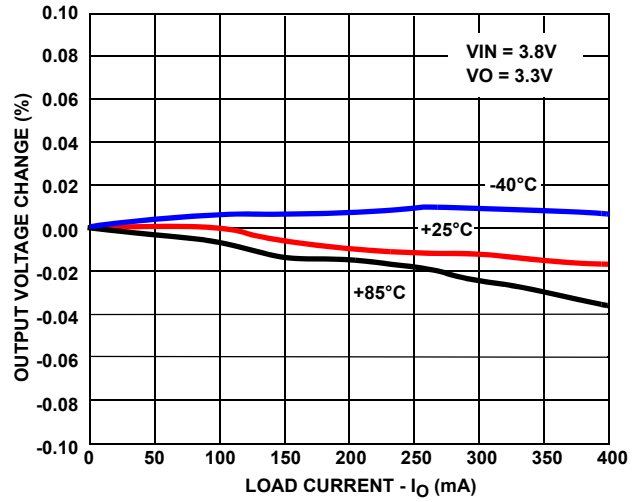

FIGURE 2. OUTPUT VOLTAGE CHANGE vs LOAD CURRENT

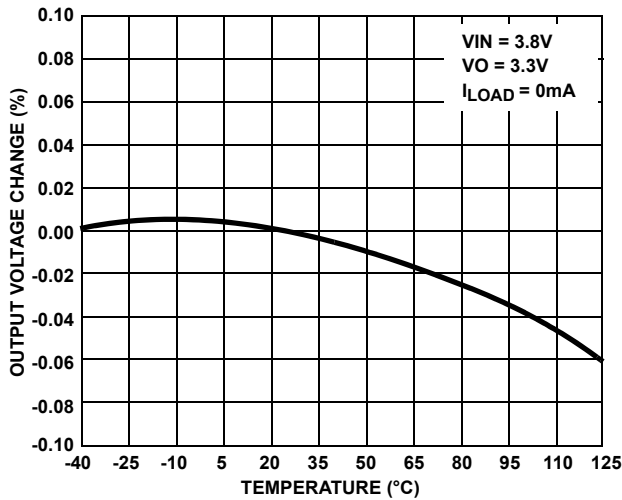

FIGURE 3. OUTPUT VOLTAGE CHANGE vs TEMPERATURE

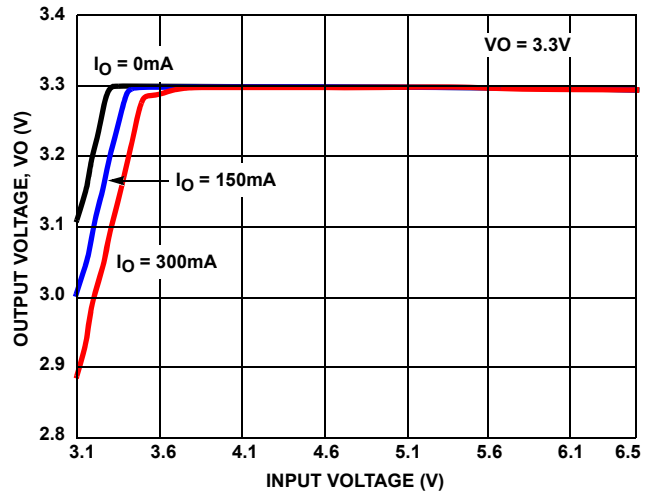

FIGURE 4. OUTPUT VOLTAGE vs INPUT VOLTAGE (3.3V OUTPUT)

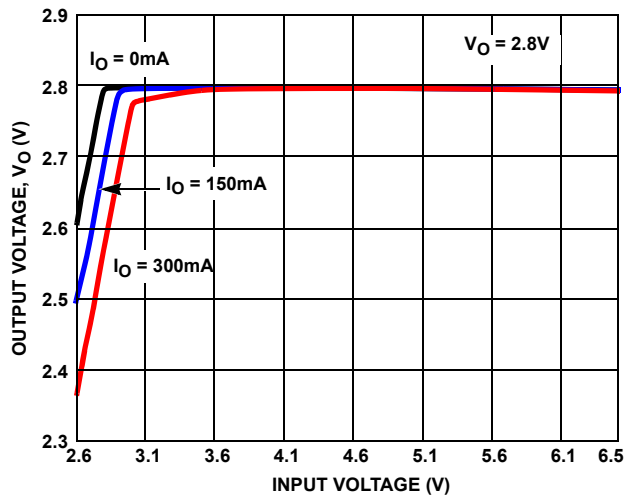

FIGURE 5. OUTPUT VOLTAGE vs INPUT VOLTAGE (2.8V OUTPUT)

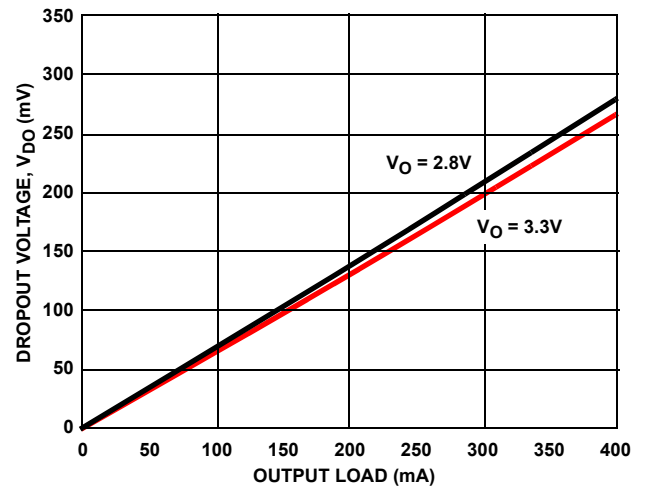

FIGURE 6. DROPOUT VOLTAGE vs LOAD CURRENT

**Typical Performance Curves** (Continued)

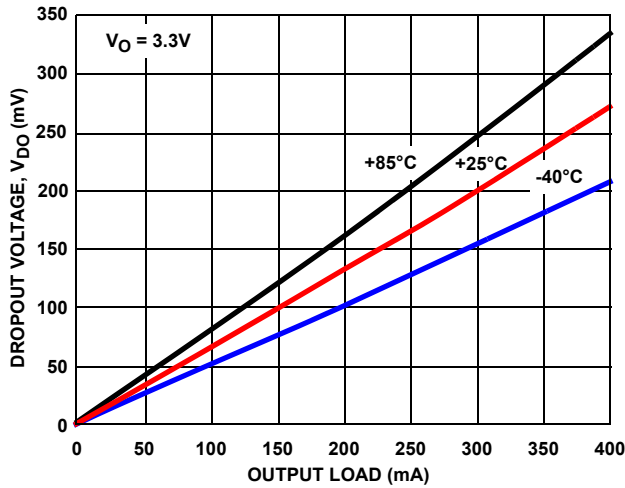

FIGURE 7. DROPOUT VOLTAGE vs LOAD CURRENT

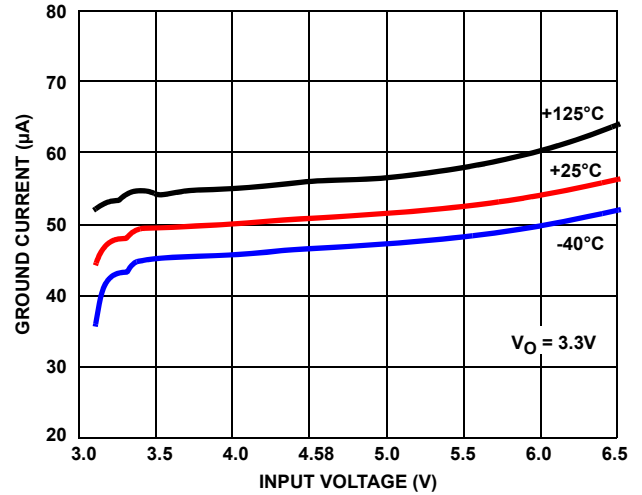

FIGURE 8. GROUND CURRENT vs INPUT VOLTAGE

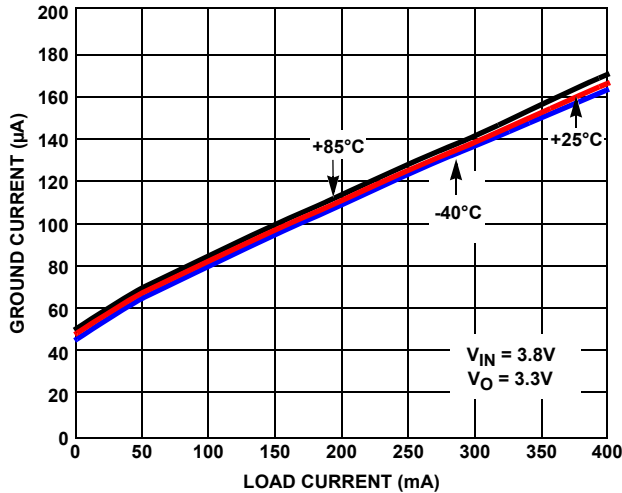

FIGURE 9. GROUND CURRENT vs LOAD

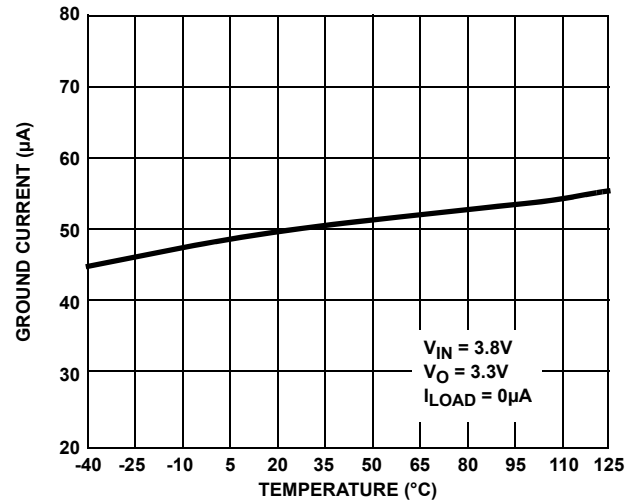

FIGURE 10. GROUND CURRENT vs TEMPERATURE

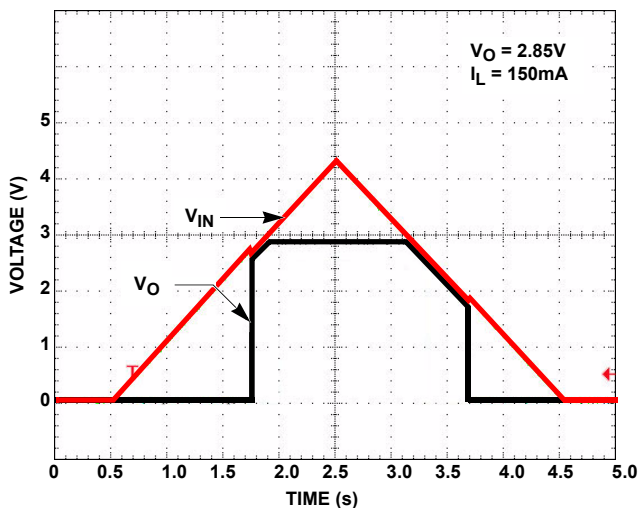

FIGURE 11. POWER-UP/POWER-DOWN

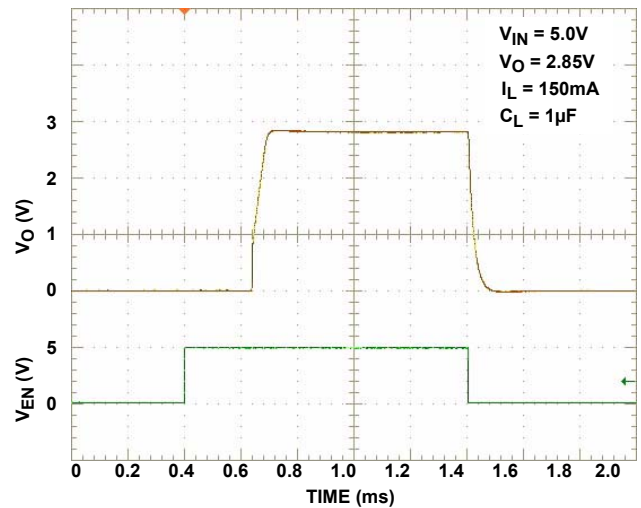

FIGURE 12. TURN-ON/TURN-OFF RESPONSE

**Typical Performance Curves** (Continued)

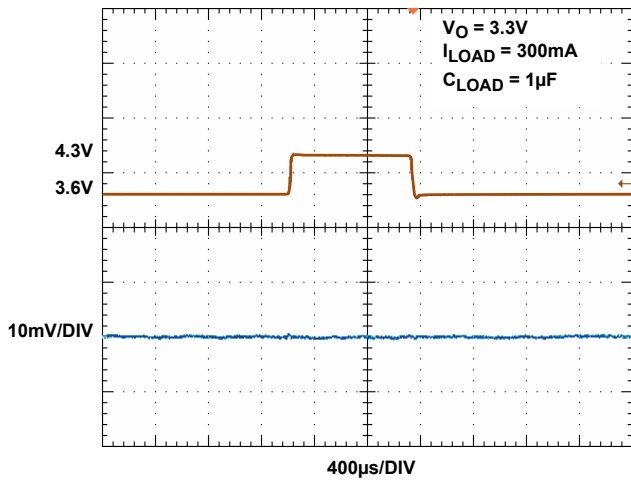

FIGURE 13. LINE TRANSIENT RESPONSE, 3.3V OUTPUT

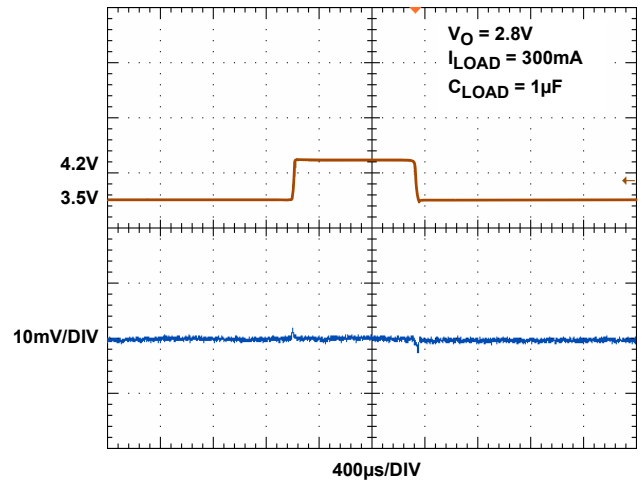

FIGURE 14. LINE TRANSIENT RESPONSE, 2.8V OUTPUT

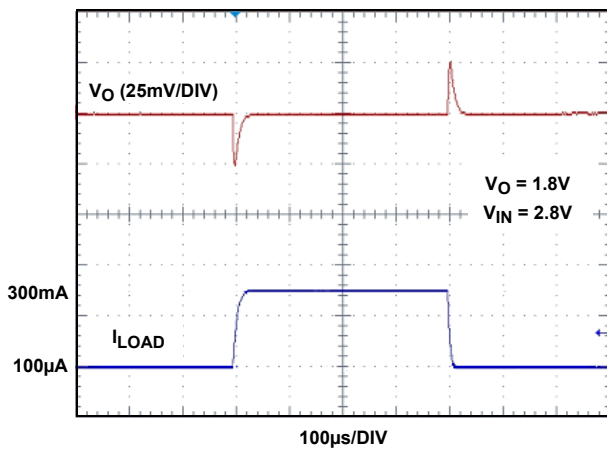

FIGURE 15. LOAD TRANSIENT RESPONSE

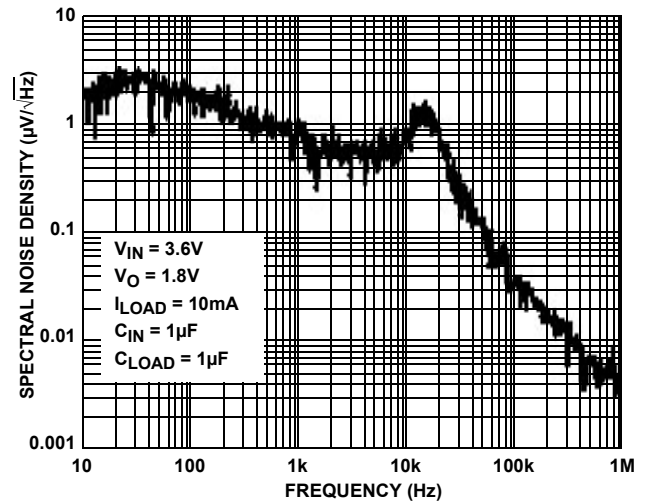

FIGURE 16. SPECTRAL NOISE DENSITY vs FREQUENCY

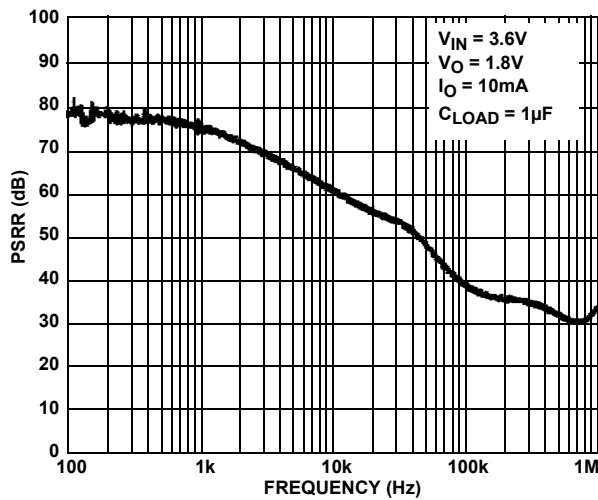
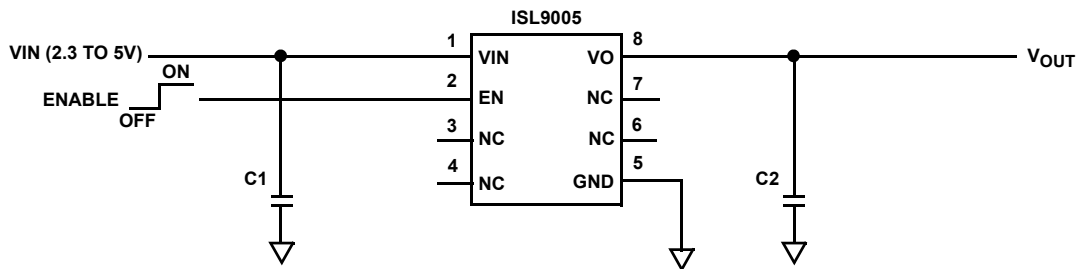

FIGURE 17. PSRR vs FREQUENCY

## Pin Description

PIN NUMBER	PIN NAME	DESCRIPTION
1	VIN	Supply Voltage/LDO Input: Connect a 1 $\mu$ F capacitor to GND.
2	EN	LDO Enable.
3	NC	Do not connect.
4	NC	Do not connect.
5	GND	GND is the connection to system ground. Connect to PCB Ground plane.
6	NC	Do not connect.
7	NC	Do not connect.
8	VO	LDO Output: Connect capacitor of value 1 $\mu$ F to 10 $\mu$ F to GND (1 $\mu$ F recommended).

## Typical Application



C<sub>1</sub>, C<sub>2</sub>: 1 $\mu$ F X5R CERAMIC CAPACITOR

© Copyright Intersil Americas LLC 2005-2008. All Rights Reserved.  
All trademarks and registered trademarks are the property of their respective owners.

For additional products, see [www.intersil.com/en/products.html](http://www.intersil.com/en/products.html)

Intersil products are manufactured, assembled and tested utilizing ISO9001 quality systems as noted in the quality certifications found at [www.intersil.com/en/support/qualandreliability.html](http://www.intersil.com/en/support/qualandreliability.html)

*Intersil products are sold by description only. Intersil may modify the circuit design and/or specifications of products at any time without notice, provided that such modification does not, in Intersil's sole judgment, affect the form, fit or function of the product. Accordingly, the reader is cautioned to verify that datasheets are current before placing orders. Information furnished by Intersil is believed to be accurate and reliable. However, no responsibility is assumed by Intersil or its subsidiaries for its use; nor for any infringements of patents or other rights of third parties which may result from its use. No license is granted by implication or otherwise under any patent or patent rights of Intersil or its subsidiaries.*

For information regarding Intersil Corporation and its products, see [www.intersil.com](http://www.intersil.com)

## Block Diagram

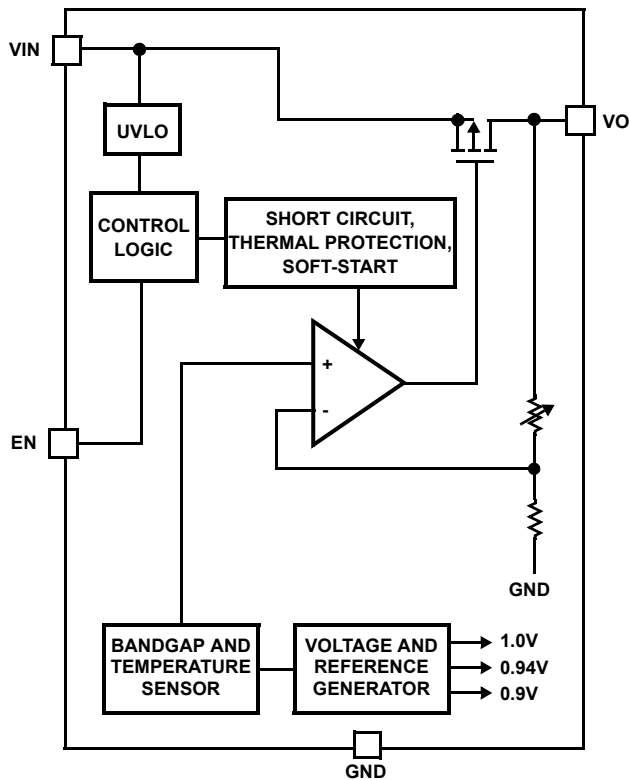

## Functional Description

The ISL9005 contains all circuitry required to implement a high performance LDO. High performance is achieved through a circuit that delivers fast transient response to varying load conditions. In a quiescent condition, the ISL9005 adjusts its biasing to achieve the lowest standby current consumption.

The device also integrates current limit protection, smart thermal shutdown protection, and soft-start. Smart Thermal shutdown protects the device against overheating.

### Power Control

The ISL9005 has an enable pin (EN) to control power to the LDO output. When EN is low, the device is in shutdown mode. During this condition, all on-chip circuits are off, and the device draws minimum current, typically less than 0.1 $\mu$ A. When the enable pin is asserted, the device first polls the output of the UVLO detector to ensure that VIN voltage is at least about 2.1V. Once verified, the device initiates a start-up sequence. During the start-up sequence, trim settings are first read and latched. Then, sequentially, the bandgap, reference voltage and current generation circuitry power-up. Once the references are stable, a fast-start circuit powers up the LDO.

During operation, whenever the VIN voltage drops below about 1.84V, the ISL9005 immediately disables the LDO output. When VIN rises back above 2.1V, the device re-initiates its start-up sequence and LDO operation will resume automatically.

### Reference Generation

The reference generation circuitry includes a trimmed bandgap, a trimmed voltage reference divider, a trimmed current reference generator, and an RC noise filter.

The bandgap generates a zero temperature coefficient (TC) voltage for the reference divider. The reference divider provides the regulation reference and other voltage references required for current generation and over-temperature detection.

The current generator outputs references required for adaptive biasing as well as references for LDO output current limit and thermal shutdown determination.

### LDO Regulation and Programmable Output Divider

The LDO Regulator is implemented with a high-gain operational amplifier driving a PMOS pass transistor. The design of the ISL9005 provides a regulator that has low quiescent current, fast transient response, and overall stability across all operating and load current conditions. LDO stability is guaranteed for a 1 $\mu$ F to 10 $\mu$ F output capacitor that has a tolerance better than 20% and ESR less than 200m $\Omega$ . The design is performance-optimized for a 1 $\mu$ F capacitor. Unless limited by the application, use of an output capacitor value above 4.7 $\mu$ F is not recommended as LDO performance improvement is minimal.

Soft-start circuitry integrated into each LDO limits the initial ramp-up rate to about 30 $\mu$ s/V to minimize current surge. The ISL9005 provides short-circuit protection by limiting the output current to about 425mA.

The LDO uses an independently trimmed 1V reference as its input. An internal resistor divider drops the LDO output voltage down to 1V. This is compared to the 1V reference for regulation. The resistor division ratio is programmed in the factory.

### Overheat Detection

The bandgap outputs a proportional-to-temperature current that is indicative of the temperature of the silicon. This current is compared with references to determine if the device is in danger of damage due to overheating. When the die temperature reaches about +140 $^{\circ}$ C, if the LDO is sourcing more than 50mA it shuts down until the die cools sufficiently. Once the die temperature falls back below about +110 $^{\circ}$ C, the disabled LDO is re-enabled and soft-start automatically takes place.

**Dual Flat No-Lead Plastic Package (DFN)**

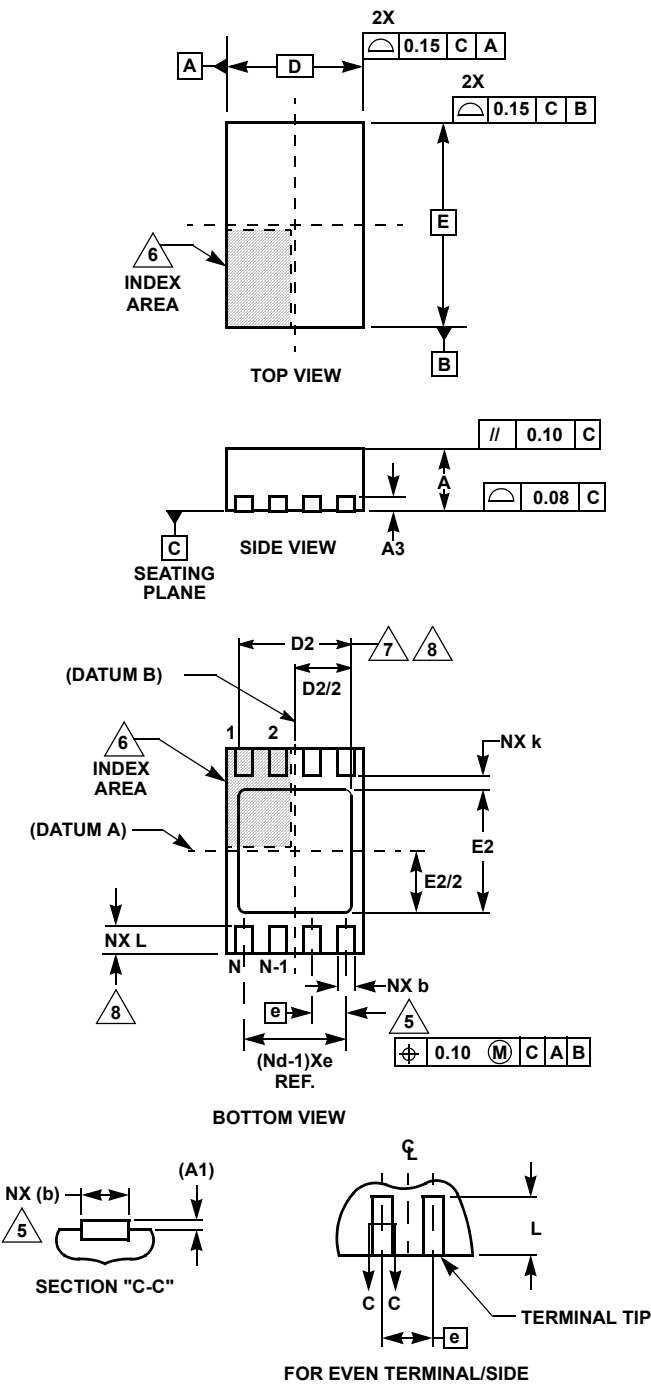

**L8.2x3**

**8 LEAD DUAL FLAT NO-LEAD PLASTIC PACKAGE**

SYMBOL	MILLIMETERS			NOTES
	MIN	NOMINAL	MAX	
A	0.80	0.90	1.00	-
A1	-	-	0.05	-
A3	0.20 REF			-
b	0.20	0.25	0.32	5,8
D	2.00 BSC			-
D2	1.50	1.65	1.75	7,8
E	3.00 BSC			-
E2	1.65	1.80	1.90	7,8
e	0.50 BSC			-
k	0.20	-	-	-
L	0.30	0.40	0.50	8
N	8			2
Nd	4			3

Rev. 0 6/04

**NOTES:**

1. Dimensioning and tolerancing conform to ASME Y14.5-1994.
2. N is the number of terminals.
3. Nd refers to the number of terminals on D.
4. All dimensions are in millimeters. Angles are in degrees.
5. Dimension b applies to the metallized terminal and is measured between 0.25mm and 0.30mm from the terminal tip.
6. The configuration of the pin #1 identifier is optional, but must be located within the zone indicated. The pin #1 identifier may be either a mold or mark feature.
7. Dimensions D2 and E2 are for the exposed pads which provide improved electrical and thermal performance.
8. Nominal dimensions are provided to assist with PCB Land Pattern Design efforts, see Intersil Technical Brief TB389.

## Looking for pricing, stock, or lifecycle information?

Click below to explore more details on WIN SOURCE:

 [View ISL9005IRFZ-T on WIN SOURCE](#)

 [Intersil Information](#)

## Optimize Your Supply Chain with WIN SOURCE Solutions

-  Global Sourcing Solution
-  Obsolete Management
-  Cost Control Management
-  Shortage Management
-  Alternative Solution
-  Excess Inventory Management