



**THE DATASHEET OF
2DB1694-7**



Features

- Epitaxial Planar Die Construction
- Low Collector-Emitter Saturation Voltage
- Ideal for Low Power Amplification and Switching
- Complementary NPN Type Available (2DD2656)
- Ultra-Small Surface Mount Package
- **Lead Free By Design/RoHS Compliant (Note 1)**
- **"Green Device" (Note 2)**



Top View

Mechanical Data

- Case: SOT-323
- Case Material: Molded Plastic, "Green" Molding Compound. UL Flammability Classification Rating 94V-0
- Moisture Sensitivity: Level 1 per J-STD-020D
- Terminals: Finish – Matte Tin annealed over Alloy 42 leadframe. Solderable per MIL-STD-202, Method 208
- Terminal Connections: See Diagram
- Marking Information: See Page 3
- Ordering Information: See Page 3
- Weight: 0.006 grams (approximate)

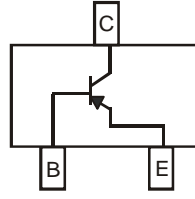

Device Schematic

Maximum Ratings @ $T_A = 25^\circ\text{C}$ unless otherwise specified

Characteristic	Symbol	Value	Unit
Collector-Base Voltage	V_{CBO}	-30	V
Collector-Emitter Voltage	V_{CEO}	-30	V
Emitter-Base Voltage	V_{EBO}	-6	V
Collector Current - Continuous	I_C	-1	A
Peak Pulse Collector Current	I_{CM}	-2	A

Thermal Characteristics

Characteristic	Symbol	Value	Unit
Power Dissipation (Note 3) @ $T_A = 25^\circ\text{C}$	P_D	300	mW
Thermal Resistance, Junction to Ambient (Note 3) @ $T_A = 25^\circ\text{C}$	$R_{\theta JA}$	417	$^\circ\text{C/W}$
Power Dissipation (Note 4) @ $T_A = 25^\circ\text{C}$	P_D	500	mW
Thermal Resistance, Junction to Ambient (Note 4) @ $T_A = 25^\circ\text{C}$	$R_{\theta JA}$	250	$^\circ\text{C/W}$
Operating and Storage Temperature Range	T_J, T_{STG}	-55 to +150	$^\circ\text{C}$

Electrical Characteristics @ $T_A = 25^\circ\text{C}$ unless otherwise specified

Characteristic	Symbol	Min	Typ	Max	Unit	Conditions
OFF CHARACTERISTICS						
Collector-Base Breakdown Voltage	$V_{(BR)CBO}$	-30	—	—	V	$I_C = -10\mu\text{A}, I_E = 0$
Collector-Emitter Breakdown Voltage (Note 5)	$V_{(BR)CEO}$	-30	—	—	V	$I_C = -1\text{mA}, I_B = 0$
Emitter-Base Breakdown Voltage	$V_{(BR)EBO}$	-6	—	—	V	$I_E = -10\mu\text{A}, I_C = 0$
Collector Cut-Off Current	I_{CBO}	—	—	-0.1	μA	$V_{CB} = -30\text{V}, I_E = 0$
Emitter Cut-Off Current	I_{EBO}	—	—	-0.1	μA	$V_{EB} = -6\text{V}, I_C = 0$
ON CHARACTERISTICS (Note 5)						
Collector-Emitter Saturation Voltage	$V_{CE(SAT)}$	—	-180	-380	mV	$I_C = -500\text{mA}, I_B = -25\text{mA}$
DC Current Gain	h_{FE}	270	—	680	—	$V_{CE} = -2\text{V}, I_C = -100\text{mA}$
SMALL SIGNAL CHARACTERISTICS						
Output Capacitance	C_{obo}	—	16	—	pF	$V_{CB} = -10\text{V}, I_E = 0, f = 1\text{MHz}$
Current Gain-Bandwidth Product	f_T	—	300	—	MHz	$V_{CE} = -2\text{V}, I_C = -100\text{mA}, f = 100\text{MHz}$

- Notes:
1. No purposefully added lead.
 2. Diode's Inc.'s "Green" policy can be found on our website at http://www.diodes.com/products/lead_free/index.php.
 3. Device mounted on FR-4 PCB with minimum recommended pad layout.
 4. Device mounted on FR-4 PCB with 1 inch² copper pad layout.
 5. Measured under pulsed conditions. Pulse width = 300 μs . Duty cycle $\leq 2\%$.

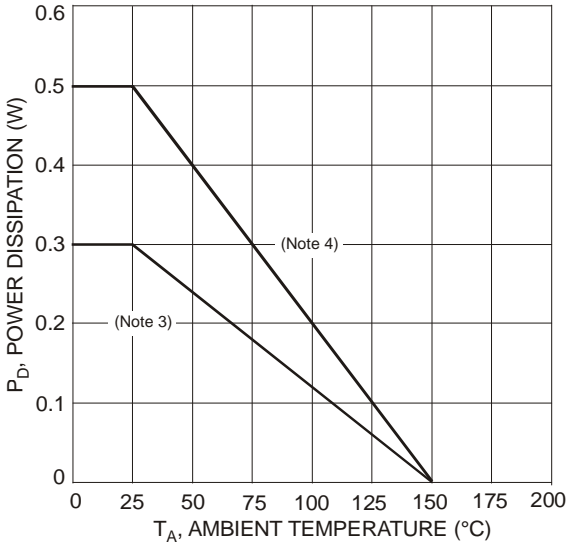

Fig. 1 Power Dissipation vs. Ambient Temperature

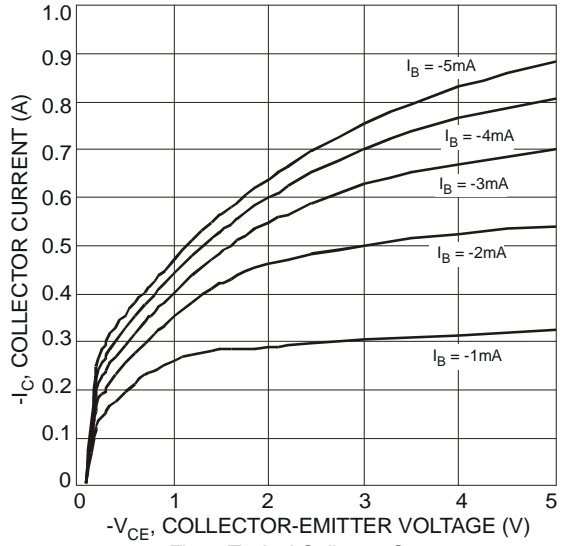

Fig. 2 Typical Collector Current vs. Collector-Emitter Voltage

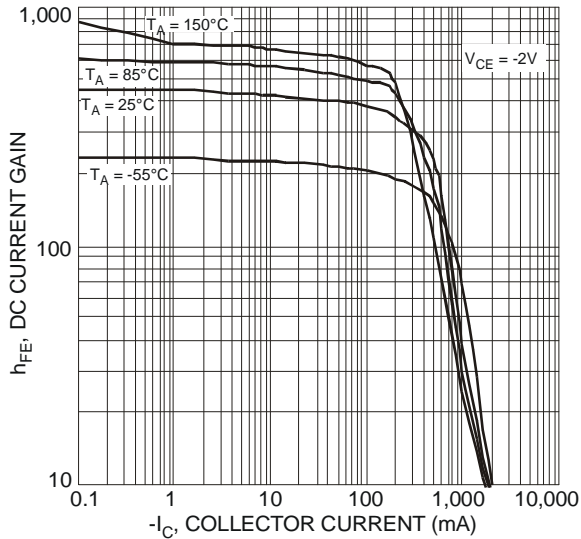

Fig. 3 Typical DC Current Gain vs. Collector Current

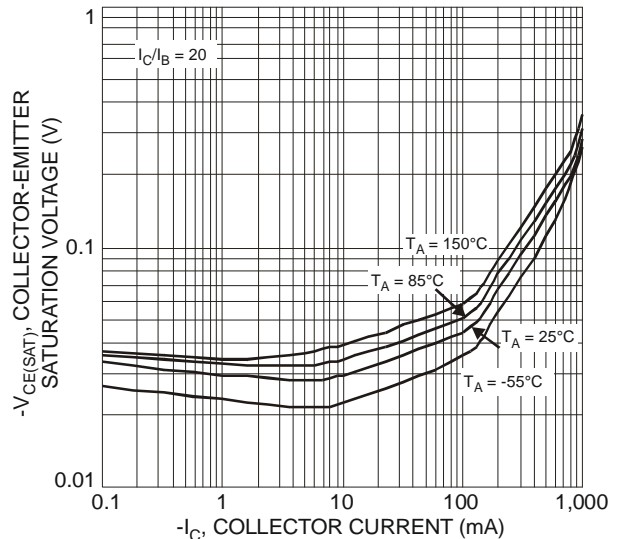

Fig. 4 Typical Collector-Emitter Saturation Voltage vs. Collector Current

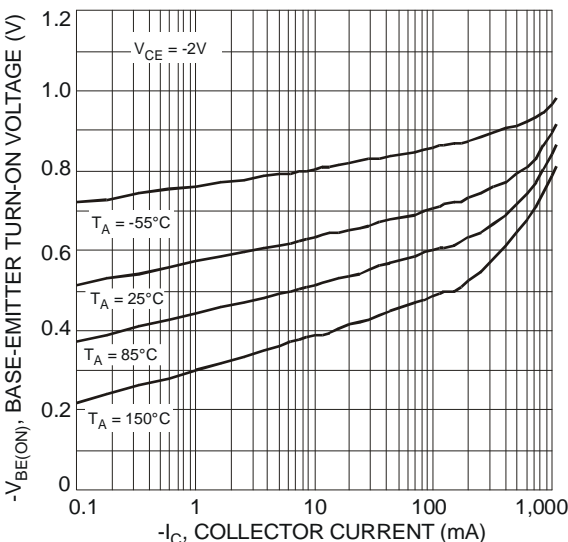

Fig. 5 Typical Base-Emitter Turn-On Voltage vs. Collector Current

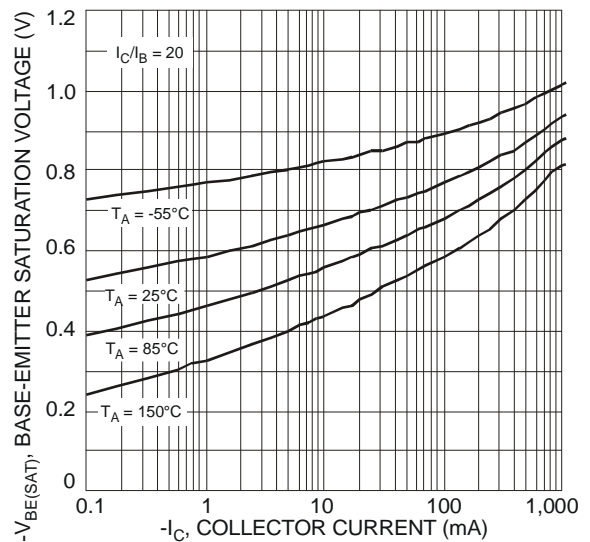

Fig. 6 Typical Base-Emitter Saturation Voltage vs. Collector Current

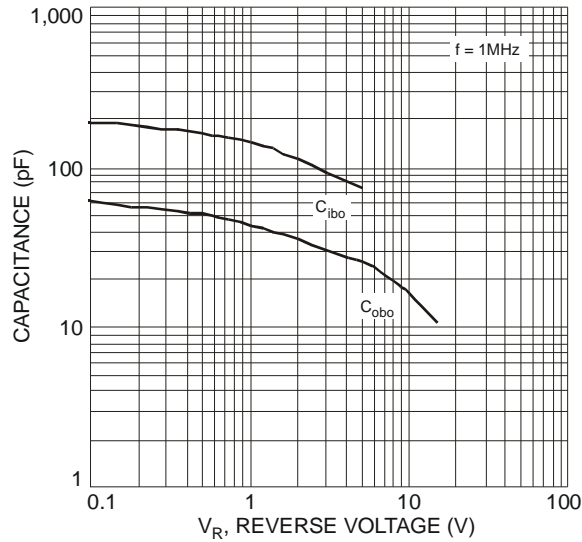

Fig. 7 Typical Capacitance Characteristics

Ordering Information (Note 6)

Part Number	Case	Packaging
2DB1694-7	SOT-323	3000/Tape & Reel

Notes: 6. For packaging details, go to our website at <http://www.diodes.com/datasheets/ap02007.pdf>.

Marking Information

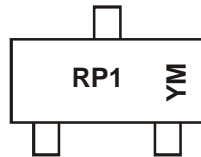

RP1 = Product Type Marking Code
 YM = Date Code Marking
 Y = Year (ex: V = 2008)
 M = Month (ex: 9 = September)

Date Code Key

Year	2008	2009	2010	2011	2012	2013	2014	2015
Code	V	W	X	Y	Z	A	B	C

Month	Jan	Feb	Mar	Apr	May	Jun	Jul	Aug	Sep	Oct	Nov	Dec
Code	1	2	3	4	5	6	7	8	9	O	N	D

Package Outline Dimensions

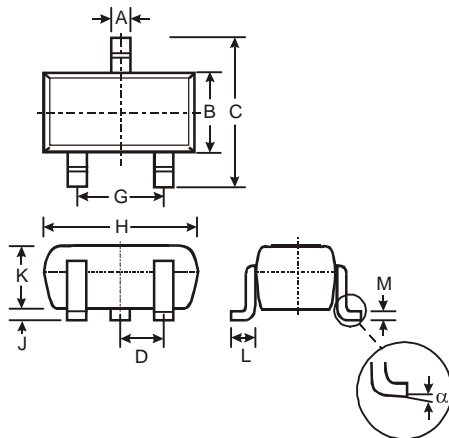

SOT-323			
Dim	Min	Max	Typ
A	0.25	0.40	0.30
B	1.15	1.35	1.30
C	2.00	2.20	2.10
D	-	-	0.65
G	1.20	1.40	1.30
H	1.80	2.20	2.15
J	0.0	0.10	0.05
K	0.90	1.00	1.00
L	0.25	0.40	0.30
M	0.10	0.18	0.11
α	0°	8°	-
All Dimensions in mm			

Suggested Pad Layout

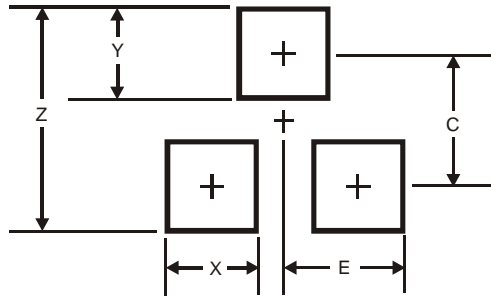

Dimensions	Value (in mm)
Z	2.8
X	0.7
Y	0.9
C	1.9
E	1.0

IMPORTANT NOTICE

Diodes Incorporated and its subsidiaries reserve the right to make modifications, enhancements, improvements, corrections or other changes without further notice to any product herein. Diodes Incorporated does not assume any liability arising out of the application or use of any product described herein; neither does it convey any license under its patent rights, nor the rights of others. The user of products in such applications shall assume all risks of such use and will agree to hold Diodes Incorporated and all the companies whose products are represented on our website, harmless against all damages.



LIFE SUPPORT

Diodes Incorporated products are not authorized for use as critical components in life support devices or systems without the expressed written approval of the President of Diodes Incorporated.

NEW PRODUCT

Looking for pricing, stock, or lifecycle information?

Click below to explore more details on WIN SOURCE:

-  [View 2DB1694-7 on WIN SOURCE](#)
-  [Diodes Incorporated Information](#)

Optimize Your Supply Chain with WIN SOURCE Solutions

-  Global Sourcing Solution
-  Obsolete Management
-  Cost Control Management
-  Shortage Management
-  Alternative Solution
-  Excess Inventory Management