ST-NXP Wireless

IMPORTANT NOTICE

Dear customer,

As from August 2nd 2008, the wireless operations of NXP have moved to a new company, ST-NXP Wireless.

As a result, the following changes are applicable to the attached document.

- **Company name - NXP B.V.** is replaced with **ST-NXP Wireless**.
- **Copyright** - the copyright notice at the bottom of each page “© NXP B.V. 200x. All rights reserved”, shall now read: “© ST-NXP Wireless 200x - All rights reserved”.
- **Web site** - <http://www.nxp.com> is replaced with <http://www.stnwireless.com>
- **Contact information** - the list of sales offices previously obtained by sending an email to salesaddresses@nxp.com , is now found at <http://www.stnwireless.com> under Contacts.

If you have any questions related to the document, please contact our nearest sales office. Thank you for your cooperation and understanding.

ST-NXP Wireless



ISP1561

Hi-Speed Universal Serial Bus PCI Host Controller

Rev. 02 — 5 March 2007

Product data sheet



1. General description

The ISP1561 is a Peripheral Component Interconnect (PCI)-based, single-chip Universal Serial Bus (USB) Host Controller. It integrates two Original USB Open Host Controller Interface (OHCI) cores, one Hi-Speed USB Enhanced Host Controller Interface (EHCI) core, and four transceivers that are compliant with Hi-Speed USB and Original USB. The functional parts of the ISP1561 are fully compliant with [Ref. 8 “Universal Serial Bus Specification”](#), [Ref. 4 “Open Host Controller Interface Specification for USB”](#), [Ref. 2 “Enhanced Host Controller Interface Specification for Universal Serial Bus”](#), [Ref. 6 “PCI Local Bus Specification”](#), and [Ref. 5 “PCI Bus Power Management Interface Specification”](#).

Integrated high performance USB transceivers allow the ISP1561 to handle all Hi-Speed USB transfer speed modes: high-speed (480 Mbit/s), full-speed (12 Mbit/s) and low-speed (1.5 Mbit/s). The ISP1561 provides four downstream ports, allowing simultaneous connection of USB devices at different speeds.

The ISP1561 provides three downstream port status indicators, GoodLink along with green and amber LEDs, to allow user-rich messages of the root hub downstream ports status, without requiring detailed port information to be reflected in internal registers.

The ISP1561 is fully compatible with various operating system drivers, such as Microsoft Windows standard OHCI and EHCI drivers that are present in Windows 98 Second Edition (SE), Windows Millennium Edition (Me), Windows XP and Windows 2000.

The ISP1561 directly interfaces to any 32-bit, 33 MHz PCI bus. It has 5 V tolerant PCI pins that can source 3.3 V. The PCI interface fully complies with [Ref. 6 “PCI Local Bus Specification”](#).

The ISP1561 is ideally suited for use in Hi-Speed USB host-enabled motherboards, Hi-Speed USB host PCI add-on card applications, mobile applications, and embedded solutions.

To facilitate motherboard development, the ISP1561 can use the available 48 MHz clock signal to reduce the total cost of a solution. To reduce the ElectroMagnetic Interference (EMI), however, it is recommended that the 12 MHz clock is used in PCI add-on card designs.

2. Features

- Complies with [Ref. 8 “Universal Serial Bus Specification”](#)
- Supports data transfer at high-speed (480 Mbit/s), full-speed (12 Mbit/s) and low-speed (1.5 Mbit/s)
- Two Original USB OHCI cores are compliant with [Ref. 4 “Open Host Controller Interface Specification for USB”](#)
- One Hi-Speed USB EHCI core is compliant with [Ref. 2 “Enhanced Host Controller Interface Specification for Universal Serial Bus”](#)
- Supports PCI 32-bit, 33 MHz interface compliant with [Ref. 6 “PCI Local Bus Specification”](#), with support for D3_{cold} standby and wake-up modes; all I/O pins are 3.3 V standard, but 5 V tolerant
- Compliant with [Ref. 5 “PCI Bus Power Management Interface Specification”](#) for all hosts (EHCI and OHCI), and supports all power states: D0, D1, D2, D3_{hot} and D3_{cold}
- Four downstream ports with support for three types of downstream port indicator LEDs: GoodLink, amber and green LEDs
- CLKRUN support for mobile applications, such as internal notebook design
- Configurable subsystem ID and subsystem vendor ID through external EEPROM
- Configurable two or four port root hub
- Digital and analog power separation
- Supports hot Plug and Play and remote wake-up of peripherals
- Supports individual power switching and individual overcurrent protection for downstream ports
- Supports partial dynamic port-routing capability for downstream ports that allows sharing of the same physical downstream ports between the Original USB Host Controller and the Hi-Speed USB Host Controller
- Supports legacy PS/2 keyboards and mice
- Uses 12 MHz crystal oscillator to reduce system cost and EMI emissions
- Operates at +3.3 V power supply input
- Full industrial operating temperature range from –40 °C to +85 °C
- Full-scan design with high fault coverage (93 % to 95 %) ensures high quality
- LQFP128 package available

3. Applications

- PC motherboard
- Notebook
- PCI add-on card
- Set-Top Box (STB)
- Web appliance

4. Ordering information

Table 1. Ordering information

Type number	Package		
	Name	Description	Version
ISP1561BM	LQFP128	plastic low profile quad flat package; 128 leads; body 14 × 14 × 1.4 mm	SOT420-1

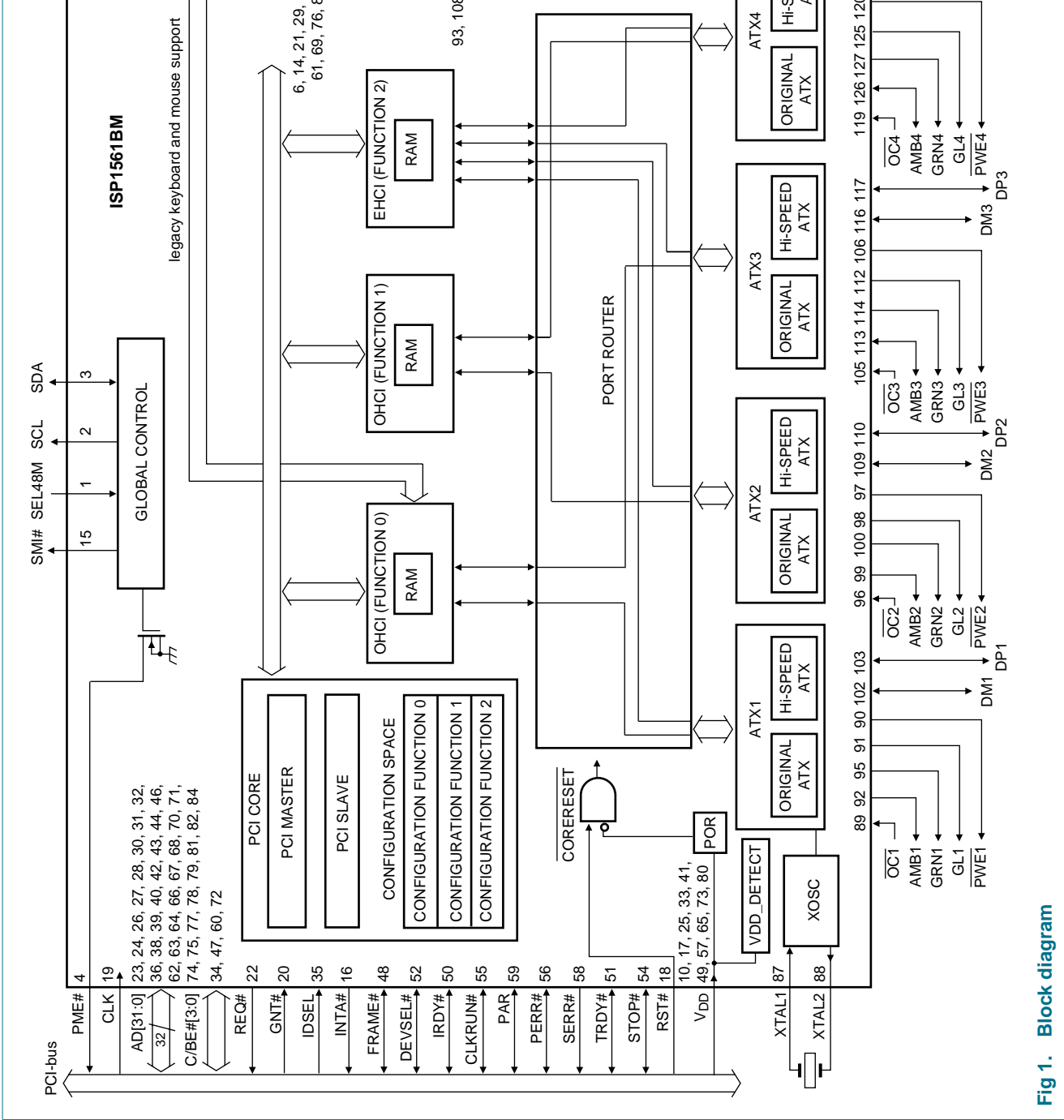

Fig 1. Block diagram

6. Pinning information

6.1 Pinning

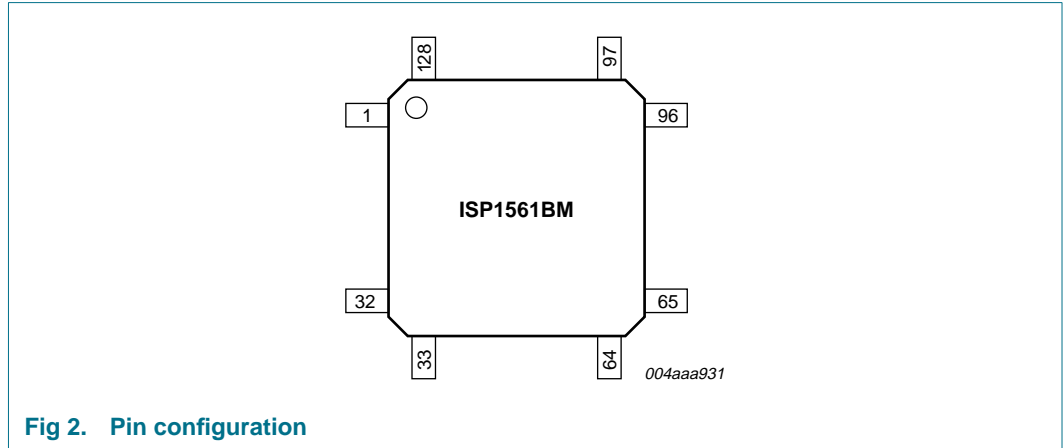

Fig 2. Pin configuration

6.2 Pin description

Table 2. Pin description

Symbol ^[1]	Pin	Type	Description
SEL48M	1	I	selection between 12 MHz crystal and 48 MHz oscillator 0 — 12 MHz crystal is used 1 — 48 MHz oscillator is used push-pull; TTL with hysteresis; 5 V tolerant
SCL	2	O	I ² C-bus clock (open-drain) ^[2]
SDA	3	I/O	I ² C-bus data (open-drain) ^[2]
PME#	4	O	PCI power management event; used by a device to request a change in the device or system power state push-pull, open-drain; 10 ns slew rate control; CMOS; 5 V tolerant
V _{AUX}	5	-	auxiliary voltage (3.3 V)
DGND	6	-	digital ground
IRQ1	7	O	system keyboard interrupt push-pull; open-drain; 10 ns slew rate control; CMOS; 5 V tolerant
IRQ12	8	O	system mouse interrupt push-pull; open-drain; 10 ns slew rate control; CMOS; 5 V tolerant
SEL2PORTS	9	I	active downstream port selection 0 — all the four ports are active 1 — only port 1 and port 2 are active; port 3 and port 4 are inactive push-pull; TTL with hysteresis; 5 V tolerant
V _{DD}	10	-	supply voltage (3.3 V)

Table 2. Pin description ...continued

Symbol ^[1]	Pin	Type	Description
A20OUT	11	O	legacy gate 20 output push-pull; open-drain; 10 ns slew rate control; CMOS; 5 V tolerant
KBIRQ1	12	I	legacy keyboard interrupt input push-pull; TTL with hysteresis; 5 V tolerant ^[3]
MUIRQ12	13	I	legacy mouse interrupt input push-pull; TTL with hysteresis; 5 V tolerant ^[3]
DGND	14	-	digital ground
SMI#	15	O	system management interrupt open-drain; push-pull; 10 ns slew rate control; CMOS; 5 V tolerant
INTA#	16	O	PCI interrupt push-pull, open-drain; 10 ns slew rate control; CMOS; 5 V tolerant
V _{DD}	17	-	supply voltage (3.3 V)
RST#	18	I	PCI reset; used to bring PCI-specific registers, sequencers and signals to a consistent state push-pull; TTL with hysteresis; 5 V tolerant
CLK	19	I	PCI system clock (33 MHz)
GNT#	20	I	PCI grant; indicates to the agent that access to the bus has been granted
DGND	21	-	digital ground
REQ#	22	O	PCI request; indicates to the arbitrator that the agent wants to use the bus
AD[31]	23	I/O	bit 31 of multiplexed PCI address and data
AD[30]	24	I/O	bit 30 of multiplexed PCI address and data
V _{DD}	25	-	supply voltage (3.3 V)
AD[29]	26	I/O	bit 29 of multiplexed PCI address and data
AD[28]	27	I/O	bit 28 of multiplexed PCI address and data
AD[27]	28	I/O	bit 27 of multiplexed PCI address and data
DGND	29	-	digital ground
AD[26]	30	I/O	bit 26 of multiplexed PCI address and data
AD[25]	31	I/O	bit 25 of multiplexed PCI address and data
AD[24]	32	I/O	bit 24 of multiplexed PCI address and data
V _{DD}	33	-	supply voltage (3.3 V)
C/BE#[3]	34	I/O	byte 3 of multiplexed PCI bus command and byte enable
IDSEL	35	I	PCI initialization device select; used as a chip select during configuration read and write transactions
AD[23]	36	I/O	bit 23 of multiplexed PCI address and data
DGND	37	-	digital ground
AD[22]	38	I/O	bit 22 of multiplexed PCI address and data
AD[21]	39	I/O	bit 21 of multiplexed PCI address and data
AD[20]	40	I/O	bit 20 of multiplexed PCI address and data

Table 2. Pin description ...continued

Symbol ^[1]	Pin	Type	Description
V _{DD}	41	-	supply voltage (3.3 V)
AD[19]	42	I/O	bit 19 of multiplexed PCI address and data
AD[18]	43	I/O	bit 18 of multiplexed PCI address and data
AD[17]	44	I/O	bit 17 of multiplexed PCI address and data
DGND	45	-	digital ground
AD[16]	46	I/O	bit 16 of multiplexed PCI address and data
C/BE#[2]	47	I/O	byte 2 of multiplexed PCI bus command and byte enable
FRAME#	48	I/O	PCI cycle frame; driven by the master to indicate the beginning and duration of an access
V _{DD}	49	-	supply voltage (3.3 V)
IRDY#	50	I/O	PCI initiator ready; indicates ability of the initiating agent to complete the current data phase of a transaction
TRDY#	51	I/O	PCI target ready; indicates ability of the target agent to complete the current data phase of a transaction
DEVSEL#	52	I/O	PCI device select; indicates if any device has been selected on the bus
DGND	53	-	digital ground
STOP#	54	I/O	PCI stop; indicates that the current target is requesting the master to stop the current transaction
CLKRUN#	55	I/O	PCI CLKRUN signal push-pull input; 3-state output; 5 ns slew rate control; TTL with hysteresis; 5 V tolerant
PERR#	56	I/O	PCI parity error; used to report data parity errors during all PCI transactions, except a special cycle
V _{DD}	57	-	supply voltage (3.3 V)
SERR#	58	O	PCI system error; used to report address parity errors, data parity errors on the Special Cycle command, or any other system error where the result will be catastrophic push-pull; open-drain; 10 ns slew rate control; CMOS; 5 V tolerant
PAR	59	I/O	PCI parity
C/BE#[1]	60	I/O	byte 1 of multiplexed PCI bus command and byte enable
DGND	61	-	digital ground
AD[15]	62	I/O	bit 15 of multiplexed PCI address and data
AD[14]	63	I/O	bit 14 of multiplexed PCI address and data
AD[13]	64	I/O	bit 13 of multiplexed PCI address and data
V _{DD}	65	-	supply voltage (3.3 V)
AD[12]	66	I/O	bit 12 of multiplexed PCI address and data
AD[11]	67	I/O	bit 11 of multiplexed PCI address and data
AD[10]	68	I/O	bit 10 of multiplexed PCI address and data
DGND	69	-	digital ground
AD[9]	70	I/O	bit 9 of multiplexed PCI address and data
AD[8]	71	I/O	bit 8 of multiplexed PCI address and data
C/BE#[0]	72	I/O	byte 0 of multiplexed PCI bus command and byte enable

Table 2. Pin description ...continued

Symbol ^[1]	Pin	Type	Description
V _{DD}	73	-	supply voltage (3.3 V)
AD[7]	74	I/O	bit 7 of multiplexed PCI address and data
AD[6]	75	I/O	bit 6 of multiplexed PCI address and data
DGND	76	-	digital ground
AD[5]	77	I/O	bit 5 of multiplexed PCI address and data
AD[4]	78	I/O	bit 4 of multiplexed PCI address and data
AD[3]	79	I/O	bit 3 of multiplexed PCI address and data
V _{DD}	80	-	supply voltage (3.3 V)
AD[2]	81	I/O	bit 2 of multiplexed PCI address and data
AD[1]	82	I/O	bit 1 of multiplexed PCI address and data
DGND	83	-	digital ground
AD[0]	84	I/O	bit 0 of multiplexed PCI address and data
V _{AUX}	85	-	auxiliary voltage (3.3 V)
DGND	86	-	digital ground
XTAL1	87	I	crystal input; directly connected to a 12 MHz crystal; when this pin is connected to an external 48 MHz oscillator source, pin XTAL2 must be left open Remark: This pin works in conjunction with pin SEL48M.
XTAL2	88	O	crystal output; directly connected to a 12 MHz crystal; when XTAL1 is connected to an external 48 MHz oscillator source, this pin must be left open Remark: This pin works in conjunction with pin SEL48M.
OC1	89	I	overcurrent sense input for the USB downstream port 1 (digital) push-pull; TTL with hysteresis; 5 V tolerant
PWE1	90	O	power enable for USB downstream port 1 (open-drain) 10 ns slew rate control; TTL; 5 V tolerant
GL1	91	O	GoodLink LED indicator output for USB downstream port 1 (open-drain); the LED is off by default, blinks on at USB traffic 10 ns slew rate control; TTL; 5 V tolerant
AMB1	92	O	amber LED indicator output for USB downstream port 1 (open-drain); the LED is off by default; the LED can be programmed to enable it to blink 10 ns slew rate control; TTL; 5 V tolerant
AV _{AUX}	93	-	analog auxiliary voltage (3.3 V); supply voltage
GND_RREF	94	-	reference ground; RREF resistor must be connected to this pin
GRN1	95	O	green LED indicator output for USB downstream port 1 (open-drain); the LED is off by default; the LED can be programmed to enable it to blink 10 ns slew rate control; TTL; 5 V tolerant
OC2	96	I	overcurrent sense input for USB downstream port 2 (digital) push-pull; TTL with hysteresis; 5 V tolerant
PWE2	97	O	power enable for USB downstream port 2 (open-drain) 10 ns slew rate control; TTL; 5 V tolerant

Table 2. Pin description ...continued

Symbol ^[1]	Pin	Type	Description
GL2	98	O	GoodLink LED indicator output for USB downstream port 2 (open-drain); the LED is off by default, blinks on at USB traffic 10 ns slew rate control; TTL; 5 V tolerant
AMB2	99	O	amber LED indicator output for USB downstream port 2 (open-drain); the LED is off by default; the LED can be programmed to enable it to blink 10 ns slew rate control; TTL; 5 V tolerant
GRN2	100	O	green LED indicator output for USB downstream port 2 (open-drain); the LED is off by default; the LED can be programmed to enable it to blink 10 ns slew rate control; TTL; 5 V tolerant
AV _{AUX_PLL}	101	-	analog auxiliary voltage (3.3 V); supply voltage for PLL
DM1	102	AI/O	D-; analog connection for USB downstream port 1
DP1	103	AI/O	D+; analog connection for USB downstream port 1
AGND	104	-	analog ground
$\overline{\text{OC}}3$	105	I	overcurrent sense input for USB downstream port 3 (digital) push-pull; TTL with hysteresis; 5 V tolerant
$\overline{\text{PWE}}3$	106	O	power enable for USB downstream port 3 (open-drain) 10 ns slew rate control; TTL; 5 V tolerant
RREF	107	AI/O	analog connection for the external resistor (12 k Ω \pm 1 %)
AV _{AUX}	108	-	analog auxiliary voltage (3.3 V); supply voltage
DM2	109	AI/O	D-; analog connection for USB downstream port 2
DP2	110	AI/O	D+; analog connection for USB downstream port 2
AGND	111	-	analog ground
GL3	112	O	GoodLink LED indicator output for USB downstream port 3 (open-drain); the LED is off by default, blinks on at USB traffic 10 ns slew rate control; TTL; 5 V tolerant
AMB3	113	I/O	amber LED indicator output for USB downstream port 3 (open-drain); the LED is off by default and can be programmed to enable it to blink; input as port indicator enable during reset; by default, pull up is enabled; if no LEDs are used, then connect this pin to ground, that is, no port indicator support bidirectional pin; push-pull input; 3-state output; 10 ns slew rate control; TTL; 5 V tolerant
GRN3	114	O	green LED indicator output for USB downstream port 3 (open-drain); the LED is off by default; the LED can be programmed to enable it to blink 10 ns slew rate control; TTL; 5 V tolerant
AV _{AUX}	115	-	analog auxiliary voltage (3.3 V); supply voltage
DM3	116	AI/O	D-; analog connection for USB downstream port 3
DP3	117	AI/O	D+; analog connection for USB downstream port 3
AGND	118	-	analog ground
$\overline{\text{OC}}4$	119	I	overcurrent sense input for USB downstream port 4 (digital) push-pull; TTL with hysteresis; 5 V tolerant

Table 2. Pin description ...continued

Symbol ^[1]	Pin	Type	Description
$\overline{\text{PWE4}}$	120	O	power enable for USB downstream port 4 (open-drain) 10 ns slew rate control; TTL; 5 V tolerant
AV_{AUX}	121	-	analog auxiliary voltage (3.3 V); supply voltage
DM4	122	AI/O	D-; analog connection for USB downstream port 4
DP4	123	AI/O	D+; analog connection for USB downstream port 4
AGND	124	-	analog ground
GL4	125	O	GoodLink LED indicator output for USB downstream port 4 (open-drain); the LED is off by default, blinks on at USB traffic 10 ns slew rate control; TTL; 5 V tolerant
AMB4	126	I/O	amber LED indicator output for USB downstream port 4 (open-drain); this pin acts as an input only during the power-up sequence and thereafter, acts as an output 1 — FF in the PMC register; supports D3 _{cold} 0 — EF in the PMC register; does not support D3 _{cold} bidirectional pin; push-pull input; 3-state output; 10 ns slew rate control; TTL; 5 V tolerant
GRN4	127	O	green LED indicator output for USB downstream port 4 (open-drain); the LED is off by default; the LED can be programmed to enable it to blink 10 ns slew rate control; TTL; 5 V tolerant
DGND	128	-	digital ground

[1] Symbol names ending with a '#' (for example, NAME#) represent active LOW signals for PCI pins. Symbol names with an overscore (for example, $\overline{\text{NAME}}$) represent active LOW signals for USB pins.

[2] The pull-up resistor must always be present even if I²C EEPROM is not used.

[3] If legacy support is not used, connect this pin to ground.

7. Functional description

7.1 OHCI Host Controller

An OHCI Host Controller transfers data to devices at the Original USB defined bit rate of 12 Mbit/s or 1.5 Mbit/s.

7.2 EHCI Host Controller

The EHCI Host Controller transfers data to a Hi-Speed USB compliant device at the Hi-Speed USB defined bit rate of 480 Mbit/s. When the EHCI Host Controller has the ownership of a port, OHCI Host Controllers are not allowed to modify the port register. All additional port bit definitions required for the enhanced Host Controller are not visible to the OHCI Host Controller.

7.3 Dynamic port-routing logic

The port-routing feature allows sharing of the same physical downstream ports between the Original USB Host Controller and the Hi-Speed USB Host Controller. This requirement of [Ref. 2 “Enhanced Host Controller Interface Specification for Universal Serial Bus”](#) provides four downstream ports that are multiplexed with the ports of the two OHCI. The first and third downstream ports are always connected to the first OHCI, and the second and fourth downstream ports are always connected to the second OHCI.

The EHCI is responsible for the port-routing switching mechanism. Two register bits are used for ownership switching. During power-on and system reset, the default ownership of all downstream ports is OHCI. The enhanced Host Controller Driver (HCD) controls the ownership during normal functionality.

7.4 Hi-Speed USB analog transceivers

The Hi-Speed USB analog transceivers directly interface to the USB cables through integrated termination resistors. These transceivers can transmit and receive serial data at all data rates: high-speed (480 Mbit/s), full-speed (12 Mbit/s) and low-speed (1.5 Mbit/s).

7.5 LED indicators for downstream ports

Indication of a good USB connection is provided through the GoodLink technology (open-drain, a maximum current of 20 mA). During enumeration, LED indicators blink momentarily corresponding to the enumeration traffic of ISP1561 downstream ports. The LED also blinks on whenever there is valid traffic to the downstream port. In suspend mode, the LED is off.

The GoodLink feature provides a user-friendly indication on the status of the USB traffic between the host and downstream hubs and devices. It is a useful diagnostics tool to isolate faulty equipment and helps to reduce field support and hotline costs.

The system designer can also program two optional port indicators, a green LED and an amber LED, to indicate the status of the Host Controller. These port indicators are implemented as per the USB specification.

All LED indicators are open-drain output.

7.6 Power management

The ISP1561 provides an advanced power management capabilities interface that is compliant with [Ref. 5 “PCI Bus Power Management Interface Specification”](#). Power is controlled and managed by the interaction between drivers and PCI registers. For a detailed description on power management, see [Section 10](#).

7.7 Legacy support

The ISP1561 provides legacy support for a USB keyboard and mouse. This means that the keyboard and mouse must be able to work even before the OS boot-up, with the necessary support in the system’s BIOS. [Section 11.2](#) provides detailed description on legacy support in the ISP1561.

7.8 Phase-Locked Loop (PLL)

A 12 MHz-to-30 MHz and 48 MHz clock multiplier PLL is integrated on-chip. This allows the use of a low-cost 12 MHz crystal, which also minimizes EMI. No external components are required for the PLL to operate.

8. PCI

8.1 PCI interface

The PCI interface has three functions. The first function (#0) and the second function (#1) are for OHCI Host Controllers, and the third function (#2) is for the EHCI Host Controller. All functions supports both master and target accesses and share the same PCI interrupt signal INTA#. These functions provide memory-mapped, addressable operational registers as required in [Ref. 4 “Open Host Controller Interface Specification for USB”](#) and [Ref. 2 “Enhanced Host Controller Interface Specification for Universal Serial Bus”](#).

Additionally, function #0 provides legacy keyboard and mouse support to comply with [Ref. 4 “Open Host Controller Interface Specification for USB”](#).

Each function has its own configuration space. The PCI enumerator must allocate the memory address space for each of these functions. Power management is implemented in each PCI function and all power states are provided. This allows the system to achieve low power consumption by switching off the functions which are not required.

8.1.1 PCI configuration space

[Ref. 6 “PCI Local Bus Specification”](#) requires that each of the three PCI functions of the ISP1561 provides its own PCI configuration registers, which can vary in size. In addition to the basic PCI configuration header registers, these functions implement the capability registers to support power management.

The registers of each of these functions are accessed by the respective driver. [Section 8.2](#) provides a detailed description of various PCI configuration registers.

8.1.2 PCI initiator and target

A PCI initiator initiates PCI transactions to the PCI bus. A PCI target responds to PCI transactions as a slave. In the ISP1561, the two open Host Controllers and the enhanced Host Controller function as both initiators or targets of PCI transactions issued by the host CPU.

All USB Host Controllers have their own operational registers that can be accessed by the system driver software. Drivers use these registers to configure the Host Controller hardware system, issue commands to it and/or monitor the status of the current hardware operation. The Host Controller plays the role of a PCI target. All operational registers of the Host Controllers are the PCI transaction targets of the CPU.

Normal USB transfers require the Host Controller to access system memory fields, which are allocated by USB HCDs and PCI drivers. The Host Controller hardware interacts with the HCD by accessing these buffers. The Host Controller works as an initiator in this case, and becomes a PCI master.

8.2 PCI configuration registers

OHCI USB Host Controllers and the EHCI USB Host Controller contain two sets of software-accessible hardware registers: PCI configuration registers and memory-mapped Host Controller registers.

A set of configuration registers is implemented for each of the three PCI functions of the ISP1561, see [Table 3](#).

Remark: In addition to the normal PCI header (from offset index 00h to 3Fh), implementation-specific registers are defined to support power management and function-specific features.

Table 3. PCI configuration space registers of OHCI1, OHCI2 and EHCI

Address (Hex)	Bits 31 to 24	Bits 23 to 16	Bits 15 to 8	Bits 7 to 0	Reset Hex Value ^[1]		
					Func0 OHCI1	Func1 OHCI2	Func2 EHCI
00	DID[15:0]		VID[15:0]		1561 1131	1561 1131	1562 1131
04	Status[15:0]		Command[15:0]		0210 0000	0210 0000	0210 0000
08	Class Code[23:0]			REVID[7:0]	0C03 1030	0C03 1030	0C03 2030
0C	BIST[7:0]	Header Type[7:0]	LT[7:0]	CLS[7:0]	0080 0000	0080 0000	0080 0000
10	BAR0[31:0]				0000 0000	0000 0000	0000 0000
14	Base Address Register 1, 2, 3, 4, 5 (Not configurable to prevent setting by the driver)				0000 0000	0000 0000	0000 0000
18							
1C							
20							
24							
28	Cardbus CIS Pointer[31:0]				0000 0000	0000 0000	0000 0000
2C	SID[15:0]	SVID[15:0]			1561 1131	1561 1131	1562 1131
30	Expansion ROM Base Address[31:0]				0000 0000	0000 0000	0000 0000
34	Reserved			CP[7:0]	0000 00DC	0000 00DC	0000 00DC
38	Reserved				0000 0000	0000 0000	0000 0000

Table 3. PCI configuration space registers of OHCI1, OHCI2 and EHCI ...continued

Address (Hex)	Bits 31 to 24	Bits 23 to 16	Bits 15 to 8	Bits 7 to 0	Reset Hex Value ^[1]		
					Func0 OHCI1	Func1 OHCI2	Func2 EHCI
3C	MAX_LAT [7:0]	MIN_GNT [7:0]	Interrupt Pin[7:0]	IL[7:0]	2A01 0100	2A01 0100	1002 0100
40	Reserved		Retry Timeout	TRDY Timeout	0000 8000	0000 8000	0000 8000
Enhanced Host Controller-specific PCI registers							
60	PORTWAKECAP[15:0]		FLADJ[7:0]	SBRN[7:0]	-	-	XX1F 2020 ^[2]
Power management registers							
DC	PMC[15:0]		NEXT_ITEM_PTR[7:0]	CAP_ID[7:0]	5202 0001	5202 0001	FF02 0001
E0	DATA[7:0]	PMCSR_BSE [7:0]	PMCSR[15:0]		0000 0000	0000 0000	0000 XX00 ^[2]

[1] Reset values that are highlighted (for example, **0**) indicate read and write accesses; and reset values that are not highlighted (for example, 0) indicate read-only.

[2] XX is 1Fh for four ports or 07h for two ports.

The HCD does not usually interact with the PCI configuration space. The configuration space is used only by the PCI enumerator to identify the USB Host Controller and assign appropriate system resources by reading the Vendor ID (VID) and the Device ID (DID).

8.2.1 PCI configuration header registers

The enhanced Host Controller implements normal PCI header register values, except the values for the memory-mapping base address register, serial bus number and device ID.

8.2.1.1 Vendor ID register (address: 00h)

This read-only register identifies the manufacturer of the device. PCI Special Interest Group (PCI-SIG) assigns valid vendor identifiers to ensure the uniqueness of the identifier. The bit description is shown in [Table 4](#).

Table 4. Vendor ID register: bit description

Bit	Symbol	Access	Value	Description
15 to 0	VID[15:0]	R	1131h	Vendor ID: This read-only register value is assigned to NXP Semiconductors by PCI-SIG as 1131h.

8.2.1.2 Device ID register (address: 02h)

Device ID is a 2-byte read-only register that identifies a particular device. This identifier is allocated by NXP Semiconductors. [Table 5](#) shows the bit description of the register.

Table 5. Device ID register: bit description

Bit	Symbol	Access	Value	Description
15 to 0	DID[15:0]	R	X ^[1]	Device ID: This register value is defined by NXP Semiconductors to identify the USB Host Controller IC product. For the ISP1561, NXP Semiconductors has defined OHCI functions as 1561h, and the EHCI function as 1562h.

[1] X is 1561h for OHCI1 and OHCI2 and X is 1562h for EHCI.

8.2.1.3 Command register (address: 04h)

This is a 2-byte register that provides coarse control over the ability of a device to generate and respond to PCI cycles. The bit allocation of the Command register is given in Table 6. When logic 0 is written to this register, the device is logically disconnected from the PCI bus for all accesses, except configuration accesses. All devices are required to support this base level of functionality. Individual bits in the Command register may or may not support this base level of functionality.

Table 6. Command register: bit allocation

Bit	15	14	13	12	11	10	9	8
Symbol	reserved						FBBE	SERRE
Reset	0	0	0	0	0	0	0	0
Access	-	-	-	-	-	-	R/W	R/W
Bit	7	6	5	4	3	2	1	0
Symbol	SCTRL	PER	VGAPS	MWIE	SC	BM	MS	IOS
Reset	0	0	0	0	0	0	0	0
Access	R	R/W	R	R/W	R	R/W	R/W	R/W

Table 7. Command register: bit description

Bit	Symbol	Description
15 to 10	-	reserved
9	FBBE	Fast Back-to-Back Enable: This bit controls whether a master can do fast back-to-back transactions to various devices. The initialization software must set this bit if all targets are fast back-to-back capable. 0 — Fast back-to-back transactions are only allowed to the same agent (value after RST#). 1 — The master is allowed to generate fast back-to-back transactions to different agents.
8	SERRE	SERR# Enable: This bit is an enable bit for the SERR# driver. All devices that have an SERR# pin must implement this bit. Address parity errors are reported only if this bit and the PER bit are logic 1. 0 — Disable the SERR# driver. 1 — Enable the SERR# driver.
7	SCTRL	Stepping Control: This bit controls whether a device does address and data stepping. Devices that never do stepping must clear this bit. Devices that always do stepping must set this bit. Devices that can do either, must make this bit read/write and initialize it to logic 1 after RST#.
6	PER	Parity Error Response: This bit controls the response of a device to parity errors. When the bit is set, the device must take its normal action when a parity error is detected. When the bit is logic 0, the device sets its Detected Parity Error status bit (bit 15 in the Status register) when an error is detected, but does not assert PERR# and continues normal operation. The state of this bit after RST# is logic 0. Devices that check parity must implement this bit. Devices are required to generate parity, even if parity checking is disabled.

Table 7. Command register: bit description ...continued

Bit	Symbol	Description
5	VGAPS	VGA Palette Snoop: This bit controls how VGA compatible and graphics devices handle accesses to VGA palette registers. When this bit is logic 1, palette snooping is enabled (that is, the device does not respond to palette register writes and snoops data). When the bit is logic 0, the device must treat palette write accesses like all other accesses. VGA compatible devices should implement this bit.
4	MWIE	Memory Write and Invalidate Enable: This is an enable bit for using the Memory Write and Invalidate command. When this bit is logic 1, masters may generate the command. When it is logic 0, Memory Writes must be used instead. State after RST# is logic 0. This bit must be implemented by master devices that can generate the Memory Write and Invalidate command.
3	SC	Special Cycles: Controls the action of a device on special cycle operations. A value of logic 0 causes the device to ignore all special cycle operations. A value of logic 1 allows the device to monitor special cycle operations. State after RST# is logic 0.
2	BM	Bus Master: Controls the ability of a device to act as a master on the PCI bus. A value of logic 0 disables the device from generating PCI accesses. A value of logic 1 allows the device to behave as a bus master. State after RST# is logic 0.
1	MS	Memory Space: Controls the response of a device to memory space accesses. A value of logic 0 disables the device response. A value of logic 1 allows the device to respond to memory space accesses. State after RST# is logic 0.
0	IOS	IO Space: Controls the response of a device to I/O space accesses. A value of logic 0 disables the device response. A value of logic 1 allows the device to respond to I/O space accesses. State after RST# is logic 0.

8.2.1.4 Status register (address: 06h)

The Status register is a 2-byte read-only register used to record status information on PCI bus-related events (bit allocation: see [Table 8](#)).

Table 8. Status register: bit allocation

Bit	15	14	13	12	11	10	9	8
Symbol	DPE	SSE	RMA	RTA	STA	DEVSEL[1:0]		MDPE
Reset	0	0	0	0	0	0	1	0
Access	R	R	R	R	R	R	R	R
Bit	7	6	5	4	3	2	1	0
Symbol	FBBC	reserved	66MC	CL	reserved			
Reset	0	0	0	1	0	0	0	0
Access	R	-	R	R	-	-	-	-

Table 9. Status register: bit description

Bit	Symbol	Description
15	DPE	Detected Parity Error: This bit must be set by the device whenever it detects a parity error, even if the parity error handling is disabled.
14	SSE	Signaled System Error: This bit must be set whenever the device asserts SERR#. Devices that never assert SERR# do not need to implement this bit.
13	RMA	Received Master Abort: This bit must be set by a master device whenever its transaction, except for special cycle, is terminated with master abort. All master devices must implement this bit.
12	RTA	Received Target Abort: This bit must be set by a master device whenever its transaction is terminated with target abort. All master devices must implement this bit.
11	STA	Signaled Target Abort: This bit must be set by a target device whenever it terminates a transaction with target abort. Devices that never signal target abort do not need to implement this bit.
10 to 9	DEVSELT[1:0]	DEVSEL Timing: These bits encode the timing of DEVSEL#. There are three allowable timing for assertion of DEVSEL#: <ul style="list-style-type: none"> 00b — for fast 01b — for medium 10b — for slow 11b — is reserved These bits are read-only and must indicate the slowest time that a device asserts DEVSEL# for any bus command, except Configuration Read and Configuration Write.
8	MDPE	Master Data Parity Error: This bit is implemented by bus masters. It is set when the following three conditions are met: <ul style="list-style-type: none"> • The bus agent asserted PERR# itself, on a read; or observed PERR# asserted, on a write. • The agent setting the bit acted as the bus master for the operation in which error occurred. • The Parity Error Response bit (in the Command register) is set.
7	FBBC	Fast Back-to-Back Capable: This read-only bit indicates whether the target is capable of accepting fast back-to-back transactions when the transactions are not to the same agent. This bit can be set to logic 1 if the device can accept these transactions; and must be set to logic 0 otherwise.
6	-	reserved
5	66MC	66 MHz Capable: This read-only bit indicates whether this device is capable of running at 66 MHz. A value of logic 0 indicates 33 MHz, and a value of logic 1 indicates 66 MHz.
4	CL	Capabilities List: This read-only bit indicates whether this device implements the pointer for a new capabilities linked list at offset 34h. A value of logic 0 indicates that no new capabilities linked list is available. A value of logic 1 indicates that the value read at offset 34h is a pointer in configuration space to a linked list of new capabilities.
3 to 0	-	reserved

8.2.1.5 Revision ID register (address: 08h)

This 1-byte read-only register indicates a device-specific revision identifier. The value is chosen by the vendor. This field is a vendor-defined extension of the device ID. The Revision ID register bit description is given in [Table 10](#).

Table 10. Revision ID register: bit description

Bit	Symbol	Access	Value	Description
7 to 0	REVID[7:0]	R	30h	Revision ID: This byte specifies the design revision number of functions.

8.2.1.6 Class Code register (address: 09h)

Class Code is a 24-bit read-only register used to identify the generic function of the device, and in some cases, a specific register-level programming interface. [Table 11](#) shows the bit allocation of the register.

The Class Code register is divided into three byte-size fields. The upper byte is a base class code that broadly classifies the type of function the device performs. The middle byte is a sub-class code that identifies more specifically the function of the device. The lower byte identifies a specific register-level programming interface, if any, so that device-independent software can interact with the device.

Table 11. Class Code register: bit allocation

Bit	23	22	21	20	19	18	17	16
Symbol	BCC[7:0]							
Reset	0Ch							
Access	R							
Bit	15	14	13	12	11	10	9	8
Symbol	SCC[7:0]							
Reset	03h							
Access	R							
Bit	7	6	5	4	3	2	1	0
Symbol	RLPI[7:0]							
Reset	X ^[1]							
Access	R							

[1] X is 10h for OHCI1 and OHCI2; X is 20h for EHCI.

Table 12. Class Code register: bit description

Bit	Symbol	Description
23 to 16	BCC[7:0]	Base Class Code: 0Ch is the base class code assigned to this byte, and it implies a serial bus controller.
15 to 8	SCC[7:0]	Sub-Class Code: 03h is the sub-class code assigned to this byte, and it implies the USB Host Controller.
7 to 0	RLPI[7:0]	Register-Level Programming Interface: 10h is the programming interface code assigned to OHCI, which is USB 1.1 specification compliant. 20h is the programming interface code assigned to EHCI, which is USB 2.0 specification compliant.

8.2.1.7 CacheLine Size register (address: 0Ch)

The CacheLine Size register is a read/write single-byte register that specifies the system cacheline size in units of DWORDs. This register must be implemented by master devices that can generate the Memory Write and Invalidate command. The value in this register is also used by master devices to determine whether to use the Read, Read Line, or Read Multiple command to access memory.

Slave devices that want to allow memory bursting using cacheline-wrap addressing mode must implement this register to know when a burst sequence wraps to the beginning of the cacheline.

This field must be initialized to logic 0 on activation of RST#. [Table 13](#) shows the bit description of the CacheLine Size register.

Table 13. CacheLine Size register: bit description

Bit	Symbol	Access	Value	Description
7 to 0	CLS[7:0]	R/W	00h	CacheLine Size: This byte identifies the system cacheline size.

8.2.1.8 Latency Timer register (address: 0Dh)

This 1-byte register specifies, in units of PCI bus clocks, the value of the latency timer for the PCI bus master. The Latency Time register bit description is given in [Table 14](#).

This register must be implemented as writable by any master that can burst more than two data phases. This register may be implemented as read-only for devices that burst two or fewer data phases, but the fixed value must be limited to 16 or less. The register must be initialized to logic 0 at RST#, if programmable.

Table 14. Latency Timer register: bit description

Bit	Symbol	Access	Value	Description
7 to 0	LT[7:0]	R/W	00h	Latency Timer: This byte identifies the latency timer.

8.2.1.9 Header Type register (address: 0Eh)

The Header Type register identifies the layout of the second part of the predefined header, beginning at byte 10h in configuration space. It also identifies whether the device contains multiple functions (bit allocation: see [Table 15](#)).

Table 15. Header Type register: bit allocation

Bit	7	6	5	4	3	2	1	0
Symbol	MFD				HT[6:0]			
Reset	1	0	0	0	0	0	0	0
Access	R	R	R	R	R	R	R	R

Table 16. Header Type register: bit description

Bit	Symbol	Description
7	MFD	Multi-Function Device: This bit identifies a multifunction device. If the bit is logic 0, then the device has a single function. If the bit is logic 1, then the device has multiple functions.
6 to 0	HT[6:0]	Header Type: These bits identify the layout of the part of the predefined header, beginning at byte 10h in configuration space.

8.2.1.10 BIST register (address: 0Fh)

This register is used for control and status of Built In Self Test (BIST). Devices that do not support BIST must always return logic 0, that is, treat it as a reserved register. A device whose BIST is invoked must not prevent normal operation of the PCI bus. The BIST register is not used in the ISP1561. Therefore, the logic value returned is always zero.

8.2.1.11 Base Address registers

Power-up software must build a consistent address map before booting the machine to an operating system. This means it must determine how much memory is in the system, and how much address space the I/O controllers in the system require. After determining this information, power-up software can map the I/O controllers into reasonable locations and proceed with system boot. To do this mapping in a device-independent manner, base registers for this mapping are placed in the predefined header portion of configuration space.

Bit 0 in all Base Address registers is read-only and used to determine whether the register maps into memory or I/O space. Base Address registers that map to memory space must return logic 0 in bit 0. Base Address registers that map to I/O space must return logic 1 in bit 0.

The bit description of the BAR0 register is given in [Table 17](#).

Base Address register 0 (BAR0) — (address: 10h)

Table 17. BAR0 register: bit description

Bit	Symbol	Access	Value	Description
31 to 0	BAR0[31:0]	R/W	0000 0000h	Base Address to Memory-Mapped Host Controller Register Space: The memory size required by OHCI and EHCI are 4 kB and 256 bytes, respectively. Therefore, BAR0[31:12] is assigned to the two OHCI ports, and BAR0[31:8] is assigned to the EHCI port.

Base Address register 1, 2, 3, 4, 5 (BAR1, 2, 3, 4, 5) — (address: 14h, 18h, 1Ch, 20h and 24h): The BAR1, 2, 3, 4, 5 register spaces are not used in the ISP1561.

8.2.1.12 CardBus CIS Pointer register (address: 28h)

This 4-byte register is used by devices that want to share silicon between CardBus and PCI. The CardBus CIS Pointer register is used to point to the Card Information Structure (CIS) for the CardBus card. This register is not implemented in the ISP1561.

8.2.1.13 Subsystem Vendor ID register (address: 2Ch)

The Subsystem Vendor ID register is used to uniquely identify the expansion board or subsystem where the PCI device resides. This register allows expansion board vendors to distinguish their boards, even though the boards may have the same vendor ID and device ID.

Subsystem vendor IDs are assigned by PCI-SIG to maintain uniqueness. The bit description of the Subsystem Vendor ID register is given in [Table 18](#).

Table 18. Subsystem Vendor ID register: bit description

Bit	Symbol	Access	Value	Description
15 to 0	SVID[15:0]	R	1131h	Subsystem Vendor ID: 1131h is the subsystem vendor ID assigned to NXP Semiconductors.

8.2.1.14 Subsystem ID register (address: 2Eh)

Subsystem ID values are vendor-specific. The bit description of the Subsystem ID register is given in [Table 19](#).

Table 19. Subsystem ID register: bit description

Bit	Symbol	Access	Value	Description
15 to 0	SID[15:0]	R	X ^[1]	Subsystem ID: For the ISP1561, NXP Semiconductors has defined OHCI functions as 1561h, and the EHCI function as 1562h.

[1] X is 1561h for OHCI1 and OHCI2; X is 1562h for EHCI.

8.2.1.15 Expansion ROM Base Address register (address: 30h)

Some PCI devices, especially those intended for use on expansion boards in the PC architecture, require local EPROMs for expansion ROM. This 4-byte register at offset 30h in a type 00h predefined header is defined to handle the base address and size information for this expansion ROM. The ISP1561 does not support expansion EPROM.

8.2.1.16 Capabilities Pointer register (address: 34h)

The Capabilities Pointer register is used to point to a linked list of new capabilities implemented by the device. This register is only valid if the CL bit in the Status register is set. If implemented, bit 1 and bit 0 are reserved and should be set to 00b. Software must mask these bits off before using this register as a pointer in configuration space to the first entry of a linked list of new capabilities. The bit description of the register is given in [Table 20](#).

Table 20. Capabilities Pointer register: bit description

Bit	Symbol	Access	Value	Description
7 to 0	CP[7:0]	R	DCh	Capabilities Pointer: EHCI manages power efficiently using this register. This power management register is allocated at offset DCh. Only one Host Controller is needed to manage power in the ISP1561.

8.2.1.17 Interrupt Line register (address: 3Ch)

The Interrupt Line register is a 1-byte read/write register used to communicate interrupt line routing information. This register must be implemented by any device or device function that uses an interrupt pin. The interrupt allocation is done by the BIOS. The POST software needs to write the routing information into this register because it initializes and configures the system. The bit description of the Interrupt Line register is given in [Table 21](#).

The value in this register specifies which input of the system interrupt controller(s) the interrupt pin of the device is connected. The device itself does not use this value, rather it is used by device drivers and operating systems to determine priority and vector information. Values in this register are system architecture specific.

Table 21. Interrupt Line register: bit description

Bit	Symbol	Access	Value	Description
7 to 0	IL[7:0]	R/W	00h	Interrupt Line: Indicates which IRQ is used to report interrupt from the ISP1561.

8.2.1.18 Interrupt Pin register (address: 3Dh)

This 1-byte register is use to specify which interrupt pin the device or device function uses. The bit description is given in [Table 22](#).

Devices or functions that do not use an interrupt pin must put a logic 0 in this register.

Table 22. Interrupt Pin register: bit description

Bit	Symbol	Access	Value	Description
7 to 0	IP[7:0]	R/W	01h	Interrupt Pin: INTA# is the default interrupt pin used by the ISP1561.

8.2.1.19 MIN_GNT and MAX_LAT registers (address: 3Eh and 3Fh)

The Minimum Grant (MIN_GNT) and Maximum Latency (MAX_LAT) registers are used to specify the desired settings of the device for latency timer values. For both registers, the value specifies a period of time in units of 250 ns. Values of 0 indicates that the device has no major requirements for the settings of latency timers. The MIN_GNT register bit description is given in [Table 23](#).

Table 23. MIN_GNT register: bit description

Bit	Symbol	Access	Value	Description
7 to 0	MIN_GNT[7:0]	R	X ^[1]	MIN_GNT: It is used to specify how long a burst period the device needs, assuming a clock rate of 33 MHz.

[1] X is 01h for OHC11 and OHC12; X is 02h for EHCI.

The MAX_LAT register bit description is given in [Table 24](#).

Table 24. MAX_LAT register: but description

Bit	Symbol	Access	Value	Description
7 to 0	MAX_LAT[7:0]	R	X ^[1]	MAX_LAT: It is used to specify how often the device needs to gain access to the PCI bus.

[1] X is 2Ah for OHC11 and OHC12; X is 10h for EHCI.

8.2.1.20 TRDY Timeout register (R/W: 40h)

The default and recommended value is 00h, TRDY time-out disabled. This value can, however, be modified. It is an implementation-specific register, and not a standard PCI configuration register.

The TRDY timer is 13 bits: the lower 5 bits are fixed as logic 0 and the upper 8 bits are determined by the TRDY time-out register value. The time-out is calculated by multiplying the 13-bit timer with the PCICLK cycle time.

This register determines the delay for the UE bit setting if a target does not assert its TDRY signal.

8.2.1.21 Retry Timeout register (R/W: 41h)

The default value is 80h. This value can, however, be modified. Programming this register as 00h means that retry time-out is disabled. This is an implementation-specific register, and not a standard PCI configuration register.

The time-out is determined by multiplying the register value with the PCICLK cycle time. This register determines the delay to set the UE bit if a RETRY time-out occurs.

8.2.2 Enhanced Host Controller-specific PCI registers

In addition to the PCI configuration header registers, EHCI needs some additional PCI configuration space registers to indicate the serial bus release number, downstream port wake-up event capability, and adjust the USB bus frame length for Start-Of-Frame (SOF). The EHCI-specific PCI registers are given in [Table 25](#).

Table 25. EHCI-specific PCI registers

Offset	Register
60h	Serial Bus Release Number (SBRN)
61h	Frame Length Adjustment (FLADJ)
62h to 63h	Port Wake Capability (PORTWAKECAP)

8.2.2.1 SBRN register (address: 60h)

The Serial Bus Release Number (SBRN) register is a 1-byte register, and the bit description is given in [Table 26](#). This register contains the release number of the USB specification with which this USB Host Controller module is compliant.

Table 26. SBRN register: bit description

Bit	Symbol	Access	Value	Description
7 to 0	SBRN[7:0]	R	20h	Serial Bus Specification Release Number: This register value is to identify Ref. 8 " Universal Serial Bus Specification ". All other combinations are reserved.

8.2.2.2 FLADJ register (address: 61h)

This feature is used to adjust any offset from the clock source that generates the clock that drives the SOF counter. When a new value is written to these six bits, the length of the frame is adjusted. The bit allocation of the Frame Length Adjustment (FLADJ) register is given in [Table 27](#).

Table 27. FLADJ register: bit allocation

Bit	7	6	5	4	3	2	1	0
Symbol	reserved		FLADJ[5:0]					
Reset	0	0	1	0	0	0	0	0
Access	-	-	R/W	R/W	R/W	R/W	R/W	R/W

Table 28. FLADJ register: bit description

Bit	Symbol	Description
7 to 6	-	reserved
5 to 0	FLADJ[5:0]	Frame Length Timing Value: Each decimal value change to this register corresponds to 16 high-speed bit times. The SOF cycle time, number of SOF counter clock periods to generate a SOF micro frame length, is equal to 59488 + value in this field. The default value is decimal 32 (20h), which gives a SOF cycle time of 60000. See Table 29 .

Table 29. FLADJ value as a function of SOF cycle time

FLADJ value	SOF cycle time (480 MHz)
0 (00h)	59488
1 (01h)	59504
2 (02h)	59520

Table 29. FLADJ value as a function of SOF cycle time ...continued

FLADJ value	SOF cycle time (480 MHz)
:	:
31(1Fh)	59984
32 (20h)	60000
:	:
62 (3Eh)	60480
63 (3Fh)	60496

8.2.2.3 PORTWAKECAP register (address: 62h)

The PORTWAKECAP register is a 2-byte register, and the bit description is given in [Table 30](#). This register is used to establish a policy about which ports are for wake events. Bit positions 1 to 15 in the mask correspond to a physical port implemented on the current EHCI controller. Logic 1 in a bit position indicates that a device connected below the port can be enabled as a wake-up device and the port may be enabled for disconnect or connect, or overcurrent events as wake-up events. This is an information only mask register. The bits in this register do not affect the actual operation of the EHCI Host Controller. The system-specific policy can be established by BIOS initializing this register to a system-specific value. The system software uses the information in this register when enabling devices and ports for remote wake-up.

Table 30. PORTWAKECAP register: bit description

Bit	Symbol	Access	Value	Description
15 to 0	PORTWAKECAP[15:0]	R/W	001Fh	Port Wake Up Capability Mask: EHCI does not implement this feature.

8.2.3 Power management registers

Table 31. Power management registers

Offset	Register
value read from address 34h + 0h	Capability Identifier (CAP_ID)
value read from address 34h + 1h	Next Item Pointer (NEXT_ITEM_PTR)
value read from address 34h + 2h	Power Management Capabilities (PMC)
value read from address 34h + 4h	Power Management Control/Status (PMCSR)
value read from address 34h + 6h	Power Management Control/Status PCI-to-PCI Bridge Support Extensions (PMCSR_BSE)
value read from address 34h + 7h	Data

8.2.3.1 CAP_ID register (address: value read from address 34h + 0h)

The Capability Identifier (CAP_ID) register when read by the system software as 01h indicates that the data structure currently being pointed to is the PCI power management data structure. Each function of a PCI device may have only one item in its capability list with CAP_ID set to 01h. The bit description of the register is given in [Table 32](#).

Table 32. CAP_ID register: bit description

Bit	Symbol	Access	Value	Description
7 to 0	CAP_ID[7:0]	R	01h	ID: This field when 01h identifies the linked list item as being PCI power management registers.

8.2.3.2 NEXT_ITEM_PTR register (address: value read from address 34h + 1h)

The Next Item Pointer (NEXT_ITEM_PTR) register (see [Table 33](#)) describes the location of the next item in the function's capability list. The value given is an offset into the function's PCI configuration space. If the function does not implement any other capabilities defined by the PCI-SIG for inclusion in the capabilities list, or if power management is the last item in the list, then this register must be set to 00h.

Table 33. NEXT_ITEM_PTR register: bit description

Bit	Symbol	Access	Value	Description
7 to 0	NEXT_ITEM_PTR[7:0]	R	00h	Next Item Pointer: This field provides an offset into the function's PCI configuration space pointing to the location of the next item in the function's capability list. If there are no additional items in the capabilities list, this register is set to 00h.

8.2.3.3 PMC register (address: value read from address 34h + 2h)

The Power Management Capabilities (PMC) register is a 2-byte register, and the bit allocation is given in [Table 34](#). This read-only register provides information on the capabilities of the function related to power management.

Table 34. PMC register: bit allocation

Bit	15	14	13	12	11	10	9	8
Symbol	PME_S[4:0]					D2_S	D1_S	AUX_C[2:0]
Reset	X ^[1]	1	X ^[2]	1	X ^[2]	X ^[2]	1	X ^[2]
Access	R	R	R	R	R	R	R	R
Bit	7	6	5	4	3	2	1	0
Symbol	AUX_C[2:0]		DSI	reserved	PMI	VER[2:0]		
Reset	0	0	0	0	0	0	1	0
Access	R	R	R	-	R	R	R	R

[1] X is 0 for OHCI1, OHCI2 and EHCI S1; X is 1 for EHCI S3.
 [2] X is 0 for OHCI1 and OHCI2; X is 1 for EHCI.

Table 35. PMC register: bit description

Bit	Symbol	Description
15 to 11	PME_S[4:0]	PME Support: This 5-bit field indicates the power states in which the function may assert PME#. Logic 0 for any bit indicates that the function is not capable of asserting the PME# signal while in that power state. PME_S[0] — PME# can be asserted from D0 PME_S[1] — PME# can be asserted from D1 PME_S[2] — PME# can be asserted from D2 PME_S[3] — PME# can be asserted from D3 _{hot} PME_S[4] — PME# can be asserted from D3 _{cold}
10	D2_S	D2 Support: If this bit is logic 1, this function supports the D2 power management state. Functions that do not support D2 must always return a value of logic 0 for this bit.
9	D1_S	D1 Support: If this bit is logic 1, this function supports the D1 power management state. Functions that do not support D1 must always return a value of logic 0 for this bit.

Table 35. PMC register: bit description ...continued

Bit	Symbol	Description
8 to 6	AUX_C[2:0]	<p>Auxiliary Current: This three-bit field reports the V_{AUX} auxiliary current requirements for the PCI function.</p> <p>If the Data register is implemented by this function:</p> <ul style="list-style-type: none"> • A read from this field needs to return a value of 000b. • The Data register takes precedence over this field for V_{AUX} current requirement reporting. <p>If the PME# generation from D3_{cold} is not supported by the function (PMC[15] = 0), this field must return a value of 000b when read.</p> <p>For functions that support PME# from D3_{cold} and do not implement the Data register, bit assignments correspond to the maximum current required for V_{AUX} are:</p> <p>111b — 375 mA 110b — 320 mA 101b — 270 mA 100b — 220 mA 011b — 160 mA 010b — 100 mA 001b — 55 mA 000b — 0 (self-powered)</p>
5	DSI	<p>Device Specific Initialization: This bit indicates whether special initialization of this function is required, beyond the standard PCI configuration header, before the generic class device driver can use it.</p> <p>Remark: This bit is not used by some operating systems. For example, Microsoft Windows and Windows NT do not use this bit to determine whether to use D3. Instead, it is determined using the capabilities of the driver.</p> <p>Logic 1 indicates that the function requires a device-specific initialization sequence, following transition to D0 uninitialized state.</p>
4	-	reserved
3	PMI	<p>PME Clock: When this bit is logic 1, it indicates that the function relies on the presence of the PCI clock for the PME# operation. When this bit is logic 0, it indicates that no PCI clock is required for the function to generate PME#. Functions that do not support the PME# generation in any state must return logic 0 for this field.</p>
2 to 0	VER[2:0]	<p>Version: A value of 010b indicates that this function complies with Ref. 5 “PCI Bus Power Management Interface Specification”.</p>

The logic level of the AMB4 pin at power-on determines the default value of PMC registers. If this pin is connected to V_{DD} as a pull-up, then the ISP1561 supports D3_{cold} (in the case of notebook design). If this pin is left open or is pulled down, then the ISP1561 does not support D3_{cold} (in the case of PCI add-on card design).

8.2.3.4 PMCSR register (address: value read from address 34h + 4h)

The Power Management Control/Status (PMCSR) register is a 2-byte register used to manage the power management state of the PCI function, as well as to allow and monitor Power Management Events (PMEs). The bit allocation of the register is given in [Table 36](#).

Table 36. PMCSR register: bit allocation

Bit	15	14	13	12	11	10	9	8
Symbol	PMES	DS[1:0]		D_S[3:0]				PMEE
Reset	X ^[1]	0	0	0	0	0	0	X ^[1]
Access	R/W	R	R	R/W	R/W	R/W	R/W	R/W
Bit	7	6	5	4	3	2	1	0
Symbol	reserved						PS[1:0]	
Reset	0	0	0	0	0	0	0	0
Access	-	-	-	-	-	-	R/W	R/W

[1] Sticky bit, if the function supports PME# from D3_{cold}, then X is indeterminate at the time of initial operating system boot; X is 0 if the function does not support PME# from D3_{cold}.

Table 37. PMCSR register: bit description

Bit	Symbol	Description
15	PMES	PME Status: This bit is set when the function normally asserts the PME# signal independent of the state of the PME_EN bit. Writing logic 1 to this bit clears it and causes the function to stop asserting PME#, if enabled. Writing logic 0 has no effect. This bit defaults to logic 0, if the function does not support the PME# generation from D3 _{cold} . If the function supports the PME# generation from D3 _{cold} , then this bit is sticky and must be explicitly cleared by the operating system each time the operating system is initially loaded.
14 to 13	DS[1:0]	Data Scale: This two-bit read-only field indicates the scaling factor when interpreting the value of the Data register. The value and meaning of this field vary, depending on which data value is selected by the D_S field. This field is a required component of the Data register (offset 7) and must be implemented, if the Data register is implemented. If the Data register is not implemented, this field must return 00b when PMCSR is read.
12 to 9	D_S[3:0]	Data Select: This four-bit field selects the data that is reported through the Data register and the D_S field. This field is a required component of the Data register (offset 7) and must be implemented if the Data register is implemented. If the Data register is not implemented, this field must return 00b when PMCSR is read.
8	PMEE	PME Enabled: Logic 1 allows the function to assert PME#. When it is logic 0, PME# assertion is disabled. This bit defaults to logic 0 if the function does not support the PME# generation from D3 _{cold} . If the function supports PME# from D3 _{cold} , then this bit is sticky and must explicitly be cleared by the operating system each time the operating system is initially loaded. Functions that do not support the PME# generation from any D-state (that is, PMC[15:11] = 0 0000b), may hardwire this bit to be read-only always returning logic 0 when read by system software.
7 to 2	-	reserved

Table 37. PMCSR register: bit description ...continued

Bit	Symbol	Description
1 to 0	PS[1:0]	<p>Power State: This two-bit field is used to determine the current power state of the EHCI function and to set the function into a new power state. The definition of the field values is given as:</p> <p>00b — for D0</p> <p>01b — for D1</p> <p>10b — for D2</p> <p>11b — for D3_{hot}</p> <p>If the software attempts to write an unsupported, optional state to this field, the write operation must complete normally on the bus; however, the data is discarded and no status change occurs.</p>

8.2.3.5 PMCSR_BSE register (address: value read from address 34h + 6h)

The PMCSR PCI-to-PCI Bridge Support Extensions (PMCSR_BSE) register supports PCI bridge-specific functionality and is required for all PCI-to-PCI bridges. The bit allocation of this register is given in [Table 38](#).

Table 38. PMCSR_BSE register: bit allocation

Bit	7	6	5	4	3	2	1	0
Symbol	BPCC_EN	B2_B3#	reserved					
Reset	R	R	R	R	R	R	R	R
Access	0 ^[1]	0 ^[1]	0	0	0	0	0	0

[1] Internally hardwired.

Table 39. PMCSR_BSE register: bit description

Bit	Symbol	Description
7	BPCC_EN	<p>Bus Power or Clock Control Enable</p> <p>1 — Indicates that the bus power or clock control mechanism as defined in Table 40 is enabled.</p> <p>0 — Indicates that the bus power or control policies as defined in Table 40 are disabled.</p> <p>When the bus power or clock control mechanism is disabled, the bridge's PMCSR PS (Power State) field cannot be used by the system software to control the power or clock of the bridge's secondary bus.</p>
6	B2_B3#	<p>B2 or B3 support for D3_{hot}: The state of this bit determines the action that is to occur as a direct result of programming the function to D3_{hot}.</p> <p>1 — Indicates that when the bridge function is programmed to D3_{hot}, its secondary bus's PCI clock will be stopped (B2).</p> <p>0 — Indicates that when the bridge function is programmed to D3_{hot}, its secondary bus will have its power removed (B3).</p> <p>This bit is only meaningful if bit 7 (BPCC_EN) is logic 1.</p>
5 to 0	-	reserved

Table 40. PCI bus power and clock control

Originating device's bridge PM state	Secondary bus PM state	Resultant actions by bridge (either direct or indirect)
D0	B0	none
D1	B1	none
D2	B2	clock stopped on secondary bus
D3 _{hot}	B2, B3	clock stopped and V _{CC} removed from secondary bus (B3 only); for definition of B2_B3#, see Table 39
D3 _{cold}	B3	none

8.2.3.6 Data register (address: value read from address 34h + 7h)

The Data register is an optional, 1-byte register that provides a mechanism for the function to report state dependent operating data, such as power consumed or heat dissipated. [Table 41](#) shows the bit description of the register.

Table 41. Data register: bit description

Bit	Symbol	Access	Value	Description
7 to 0	DATA[7:0]	R	00h	DATA: This register is used to report the state dependent data requested by the D_S (Data Select) field. The value of this register is scaled by the value reported by the DS (Data Scale) field.

9. I²C-bus interface

A simple I²C-bus interface is provided in the ISP1561 to read customized vendor ID, product ID and some other configuration bits from an external EEPROM.

The I²C-bus interface is for bidirectional communication between ICs using two serial bus wires: SDA (data) and SCL (clock). Both lines are driven by open-drain circuits and must be connected to the positive supply voltage through pull-up resistors.

9.1 Protocol

The I²C-bus protocol defines the following conditions:

- **Bus free:** both SDA and SCL are HIGH
- **START:** a HIGH-to-LOW transition on SDA, while SCL is HIGH
- **STOP:** a LOW-to-HIGH transition on SDA, while SCL is HIGH
- **Data valid:** after a START condition, data on SDA is stable during the HIGH period of SCL; data on SDA may only change while SCL is LOW

Each device on the I²C-bus has a unique slave address, which the master uses to select a device for access.

The master starts a data transfer using a START condition and ends it by generating a STOP condition. Transfers can only be initiated when the bus is free. The receiver must acknowledge each byte by means of a LOW level on SDA during the ninth clock pulse on SCL.

For detailed information, refer to [Ref. 7 “The I²C-bus Specification”](#).

9.2 Hardware connections

The ISP1561 can be connected to an external EEPROM through the I²C-bus interface. The hardware connections are shown in [Figure 3](#).

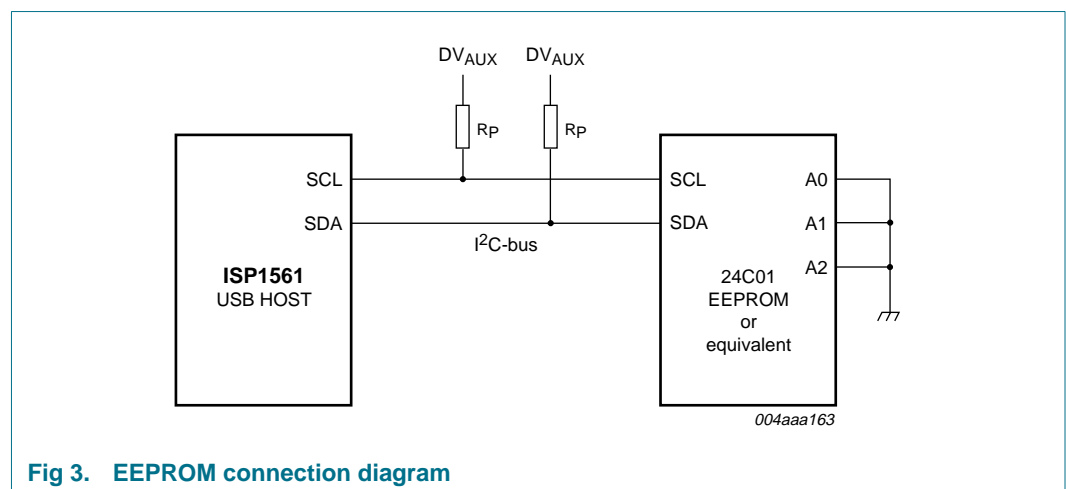
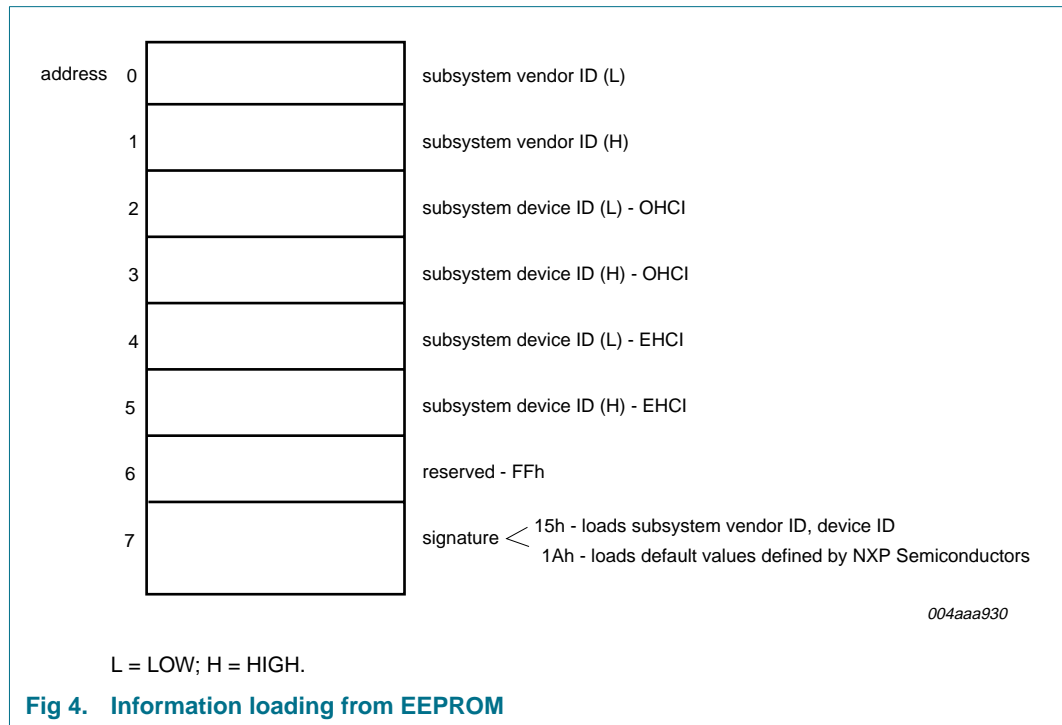

Fig 3. EEPROM connection diagram

The slave address that the ISP1561 uses to access the EEPROM is 101 0000b. Page mode addressing is not supported. Therefore, pins A0, A1 and A2 of the EEPROM must be connected to ground (logic 0).

9.3 Information loading from EEPROM

Figure 4 shows the content of the EEPROM memory. If the EEPROM is not present, the default values of Device ID (DID), Vendor ID (VID), subsystem VID and subsystem DID assigned to NXP Semiconductors by PCI-SIG will be loaded. See Table 3 for these default value. For instructions on programming the EEPROM, refer to application note Ref. 1 “Designing a Hi-Speed USB Host PCI Adapter Using the ISP1561” and user manual Ref. 3 “ISP1561 Evaluation Board User’s Guide”.



10. Power management

10.1 PCI bus power states

The PCI bus can be characterized by one of the four power management states: B0, B1, B2 and B3.

B0 state (PCI clock = 33 MHz, PCI bus power = on) — This corresponds to the bus being fully operational.

B1 state (PCI clock = intermittent clock operation mode, PCI bus power = on) — When a PCI bus is in B1, V_{DD} is still applied to all devices on the bus. No bus transactions, however, are allowed to take place on the bus. The B1 state indicates a perpetual idle state on the PCI bus.

B2 state (PCI clock = stop, PCI bus power = on) — V_{DD} is still applied on the bus, but the clock is stopped and held in the LOW state.

B3 state (PCI clock = stop, PCI bus power = off) — V_{DD} is removed from all devices on the PCI bus segment.

10.2 USB bus states

Reset state — When the USB bus is in the reset state, the USB system is stopped.

Operational state — When the USB bus is in the active state, the USB system is operating normally.

Suspend state — When the USB bus is in the suspend state, the USB system is stopped.

Resume state — When the USB bus is in the resume state, the USB system is operating normally.

11. USB Host Controller registers

Each Host Controller contains a set of on-chip operational registers that are mapped into uncached memory of the system addressable space. This memory space must begin on a DWORD (32-bit) boundary. The size of the allocated space is defined by the initial value in the BAR0 register. HCDs must interact with these registers to implement USB and legacy support functionality.

After the PCI enumeration driver finishes the PCI device configuration, the new base address of these memory-mapped operational registers is defined in BAR0. The HCD can access these registers by using the address of base address value + offset. [Table 42](#) contains a list of Host Controller registers.

Table 42. USB Host Controller registers

Address (Hex)	OHC1 register	Reset hex value[1]					
		Func0 OHC11 (2 ports)	Func0 OHC11 (1 port)	Func1 OHC12 (2 ports)	Func1 OHC12 (1 port)	Func2 EHCI (4 ports)	Func2 (2 ports)
00	HcRevision	0000 0110	0000 0110	0000 0010	0000 0010	0095 000C	0095 0000
04	HcControl	0000 0000	0000 0000	0000 0000	0000 0000	0000 2214	0000 2222
08	HcCommandStatus	0000 0000	0000 0000	0000 0000	0000 0000	0000 0012	0000 0000
0C	HcInterruptStatus	0000 0000	0000 0000	0000 0000	0000 0000	0008 0000	0008 0000
10	HcInterruptEnable	0000 0000	0000 0000	0000 0000	0000 0000	0000 1000	0000 1000
14	HcInterruptDisable	0000 0000	0000 0000	0000 0000	0000 0000	0000 0000	0000 0000
18	HcHCCA	0000 0000	0000 0000	0000 0000	0000 0000	0000 0000	0000 0000
1C	HcPeriodCurrentED	0000 0000	0000 0000	0000 0000	0000 0000	0000 0000	0000 0000
20	HcControlHeadED	0000 0000	0000 0000	0000 0000	0000 0000	0000 0000	0000 0000
24	HcControlCurrentED	0000 0000	0000 0000	0000 0000	0000 0000	0000 0000	0000 0000
28	HcBulkHeadED	0000 0000	0000 0000	0000 0000	0000 0000	-	-
2C	HcBulkCurrentED	0000 0000	0000 0000	0000 0000	0000 0000	-	-
30	HcDoneHead	0000 0000	0000 0000	0000 0000	0000 0000	-	-
34	HcFmInterval	0000 2EDF	0000 2EDF	0000 2EDF	0000 2EDF	-	-
38	HcFmRemaining	0000 0000	0000 0000	0000 0000	0000 0000	-	-
3C	HcFmNumber	0000 0000	0000 0000	0000 0000	0000 0000	-	-
40	HcPeriodicStart	0000 0000	0000 0000	0000 0000	0000 0000	-	-
44	HcLSThreshold	0000 0628	0000 0628	0000 0628	0000 0628	-	-
48	HcRhDescriptorA	FF00 0902	FF00 0901	FF00 0902	FF00 0901	-	-
4C	HcRhDescriptorB	0000 0000	0000 0000	0000 0000	0000 0000	0000 0000	0000 0000
50	HcRhStatus	0000 0000	0000 0000	0000 0000	0000 0000	0000 2000	0000 2000
54	HcRhPortStatus[1]	0000 0000	0000 0000	0000 0000	0000 0000	0000 2000	0000 2000
58	HcRhPortStatus[2]	0000 0000	-	00000000	-	0000 2000	-
5C	Reserved	-	-	-	-	0000 2000	-
FF to 60	Reserved	-	-	-	-	-	-
100	HcCeControl	0000 0000	0000 0000	0000 0000	0000 0000	-	-

Table 42. USB Host Controller registers ...continued

Address (Hex)	OHC1 register	Reset hex value ^[1]					
		Func0 OHC11 (2 ports)	Func0 OHC11 (1 port)	Func1 OHC12 (2 ports)	Func1 OHC12 (1 port)	Func2 EHCI (4 ports)	Func2 EHCI (2 ports)
104	HceInput	0000 0000	0000 0000	0000 0000	0000 0000	-	-
108	HceOutput	0000 0000	0000 0000	0000 0000	0000 0000	-	-
10C	HceStatus	0000 0000	0000 0000	0000 0000	0000 0000	-	-

[1] Reset values that are highlighted (for example, 0) are the ISP1561 implementation specific reset values, and reset values that are not highlighted with OHC1 and EHCI specification.

For the OHCI Host Controller, these registers are divided into two types: one set of operational registers for the USB operation and one set of legacy support registers for the legacy keyboard and mouse operation.

For the enhanced Host Controller, there are two types of registers: one set of read-only capability registers and one set of read/write operational registers.

11.1 OHCI USB Host Controller operational registers

OHCI HCDs must communicate with these registers to implement USB data transfers. Based on their functions, these registers are classified into four partitions:

- Control and status
- Memory pointer
- Frame counter
- Root hub

11.1.1 HcRevision register (address: content of the base address register + 00h)

Table 43. HcRevision register: bit allocation

Bit	31	30	29	28	27	26	25	24
Symbol	reserved							
Reset	0	0	0	0	0	0	0	0
Access	-	-	-	-	-	-	-	-
Bit	23	22	21	20	19	18	17	16
Symbol	reserved							
Reset	0	0	0	0	0	0	0	0
Access	-	-	-	-	-	-	-	-
Bit	15	14	13	12	11	10	9	8
Symbol	reserved							L
Reset	0	0	0	0	0	0	0	X ^[1]
Access	-	-	-	-	-	-	-	R
Bit	7	6	5	4	3	2	1	0
Symbol	REV[7:0]							
Reset	0	0	0	1	0	0	0	0
Access	R	R	R	R	R	R	R	R

[1] X is 1 for OHCI1 (2P) and OHCI1 (1P); X is 0 for OHCI2 (2P) and OHCI2 (1P).

Table 44. HcRevision register: bit description

Bit	Symbol	Description
31 to 9	-	reserved
8	L	Legacy: 0 — Does not support legacy devices 1 — Supports legacy keyboard and mouse
7 to 0	REV[7:0]	Revision: This read-only field contains the BCD representation of the version of the HCI specification that is implemented by this Host Controller. For example, a value of 11h corresponds to version 1.1. All of the Host Controller implementations that are compliant with this specification must have a value of 10h.

11.1.2 HcControl register (address: content of the base address register + 04h)

The HcControl register defines the operating modes for the Host Controller. All the fields in this register, except HCFS and RWC, are modified only by the HCD. The bit allocation is given in [Table 45](#).

Table 45. HcControl register: bit allocation

Bit	31	30	29	28	27	26	25	24
Symbol	reserved							
Reset	0	0	0	0	0	0	0	0
Access	-	-	-	-	-	-	-	-
Bit	23	22	21	20	19	18	17	16
Symbol	reserved							
Reset	0	0	0	0	0	0	0	0
Access	-	-	-	-	-	-	-	-
Bit	15	14	13	12	11	10	9	8
Symbol	reserved					RWE	RWC	IR
Reset	0	0	0	0	0	0	0	0
Access	-	-	-	-	-	R/W	R/W	R/W
Bit	7	6	5	4	3	2	1	0
Symbol	HCFS[1:0]		BLE	CLE	IE	PLE	CBSR[1:0]	
Reset	0	0	0	0	0	0	0	0
Access	R/W	R/W	R/W	R/W	R/W	R/W	R/W	R/W

Table 46. HcControl register: bit description

Bit	Symbol	Description
31 to 11	-	reserved
10	RWE	Remote Wake-up Enable: This bit is used by the HCD to enable or disable the remote wake-up feature on detecting upstream resume signaling. When this bit and the RD bit in HcInterruptStatus are set, a remote wake-up is signaled to the host system. Setting this bit has no impact on the generation of hardware interrupt.
9	RWC	Remote Wake-up Connected: This bit indicates whether the Host Controller supports remote wake-up signaling. If remote wake-up is supported and used by the system, it is the responsibility of the system firmware to set this bit during POST. The Host Controller clears the bit on a hardware reset but does not alter it on a software reset. Remote wake-up signaling of the host system is host-bus-specific and is not described in this specification.
8	IR	Interrupt Routing: This bit determines the routing of interrupts generated by events registered in HcInterruptStatus. If clear, all interrupts are routed to the normal host bus interrupt mechanism. If set, interrupts are routed to the system management interrupt. The HCD clears this bit on a hardware reset, but it does not alter this bit on a software reset. The HCD uses this bit as a tag to indicate the ownership of the Host Controller.
7 to 6	HCFS[1:0]	<p>Host Controller Functional State for USB:</p> <p>00b — USBRESET 01b — USBRESUME 10b — USBOPERATIONAL 11b — USBSUSPEND</p> <p>A transition to USBOPERATIONAL from another state causes SOF generation to begin 1 ms later. The HCD may determine whether the Host Controller has begun sending SOFs by reading the SF field of HcInterruptStatus.</p> <p>This field may be changed by the Host Controller only when in the USBSUSPEND state. The Host Controller may move from the USBSUSPEND state to the USBRESUME state after detecting the resume signaling from a downstream port.</p> <p>The Host Controller enters USBSUSPEND after a software reset; it enters USBRESET after a hardware reset. The latter also resets the root hub and asserts subsequent reset signaling to downstream ports.</p>
5	BLE	Bulk List Enable: This bit is set to enable the processing of the bulk list in the next frame. If cleared by the HCD, processing of the bulk list does not occur after the next SOF. The Host Controller checks this bit whenever it wants to process the list. When disabled, the HCD may modify the list. If HcBulkCurrentED is pointing to an Endpoint Descriptor (ED) to be removed, the HCD must advance the pointer by updating HcBulkCurrentED before re-enabling processing of the list.

Table 46. HcControl register: bit description ...continued

Bit	Symbol	Description
4	CLE	Control List Enable: This bit is set to enable the processing of the control list in the next frame. If cleared by the HCD, processing of the control list does not occur after the next SOF. The Host Controller must check this bit whenever it wants to process the list. When disabled, the HCD may modify the list. If HcControlCurrentED is pointing to an ED to be removed, the HCD must advance the pointer by updating HcControlCurrentED before re-enabling processing of the list.
3	IE	Isochronous Enable: This bit is used by the HCD to enable or disable processing of isochronous EDs. While processing the periodic list in a frame, the Host Controller checks the status of this bit when it finds an isochronous ED (that is, the Format bit of ED is logic 1; for details, refer to Ref. 4 “Open Host Controller Interface Specification for USB”). If set (enabled), the Host Controller continues processing EDs. If cleared (disabled), the Host Controller halts processing of the periodic list, which now contains only isochronous EDs, and begins processing the bulk or control lists. Setting this bit is guaranteed to take effect in the next frame and not the current frame.
2	PLE	Periodic List Enable: This bit is set to enable the processing of the periodic list in the next frame. If cleared by the HCD, processing of the periodic list does not occur after the next SOF. The Host Controller must check this bit before it starts processing the list.
1 to 0	CBSR[1:0]	Control Bulk Service Ratio: This specifies the service ratio of control EDs over bulk EDs. Before processing any of the nonperiodic lists, the Host Controller must compare the ratio specified with its internal count on how many nonempty control EDs are processed, in determining whether to continue serving another control ED or switching to bulk EDs. The internal count must be retained when crossing the frame boundary. After a reset, the HCD is responsible for restoring this value. 00b — 1 : 1 01b — 2 : 1 10b — 3 : 1 11b — 4 : 1

11.1.3 HcCommandStatus register (address: content of the base address register + 08h)

The HcCommandStatus register is used by the Host Controller to receive commands issued by the HCD. It also reflects the current status of the Host Controller. To the HCD, it appears as a “write to set” register. The Host Controller must ensure that bits written as logic 1 become set in the register while bits written as logic 0 remain unchanged in the register. The HCD may issue multiple distinct commands to the Host Controller without concern for corrupting previously issued commands. The HCD has normal read access to all bits.

The SOC[1:0] (Scheduling Overrun Count) field indicates the number of frames with which the Host Controller has detected the scheduling overrun error. This occurs when the periodic list does not complete before EOF. When a scheduling overrun error is detected, the Host Controller increments the counter and sets the SO (Scheduling Overrun) field in the HcInterruptStatus register. [Table 47](#) shows the bit allocation of the HcCommandStatus register.

Table 47. HcCommandStatus register: bit allocation

Bit	31	30	29	28	27	26	25	24
Symbol	reserved							
Reset	0	0	0	0	0	0	0	0
Access	-	-	-	-	-	-	-	-
Bit	23	22	21	20	19	18	17	16
Symbol	reserved						SOC[1:0]	
Reset	0	0	0	0	0	0	0	0
Access	-	-	-	-	-	-	R	R
Bit	15	14	13	12	11	10	9	8
Symbol	reserved							
Reset	0	0	0	0	0	0	0	0
Access	-	-	-	-	-	-	-	-
Bit	7	6	5	4	3	2	1	0
Symbol	reserved				OCR	BLF	CLF	HCR
Reset	0	0	0	0	0	0	0	0
Access	-	-	-	-	R/W	R/W	R/W	R/W

Table 48. HcCommandStatus register: bit description

Bit	Symbol	Description
31 to 18	-	reserved
17 to 16	SOC[1:0]	Scheduling Overrun Count: The bit is incremented on each scheduling overrun error. It is initialized to 00b and wraps around at 11b. It must be incremented when a scheduling overrun is detected, even if the SO bit in HcInterruptStatus is already set. This is used by the HCD to monitor any persistent scheduling problems.
15 to 4	-	reserved
3	OCR	Ownership Change Request: This bit is set by an OS HCD to request a change of control of the Host Controller. When set, the Host Controller must set the OC (Ownership Change) field in HcInterruptStatus. After the changeover, this bit is cleared and remains so until the next request from the OS HCD.
2	BLF	Bulk List Filled: This bit is used to indicate whether there are any Transfer Descriptors (TDs) on the bulk list. It is set by the HCD whenever it adds a TD to an ED in the bulk list. When the Host Controller begins to process the head of the bulk list, it checks Bulk-Filled (BF). If BLF (Bulk List Filled) is logic 0, the Host Controller does not need to process the bulk list. If BLF is logic 1, the Host Controller must start processing the bulk list and set BF to logic 0. If the Host Controller finds a TD on the list, then the Host Controller must set BLF to logic 1, causing the bulk list processing to continue. If no TD is found on the bulk list, and if the HCD does not set BLF, then BLF is still logic 0 when the Host Controller completes processing the bulk list and the bulk list processing stops.

Table 48. HcCommandStatus register: bit description ...continued

Bit	Symbol	Description
1	CLF	<p>Control List Filled: This bit is used to indicate whether there are any TDs on the control list. It is set by the HCD whenever it adds a TD to an ED in the control list.</p> <p>When the Host Controller begins to process the head of the control list, it checks CLF. If CLF is logic 0, the Host Controller does not need to process the control list. If Control-Filled (CF) is logic 1, the Host Controller must start processing the control list and set CLF to logic 0. If the Host Controller finds a TD on the list, then the Host Controller must set CLF to logic 1, causing the control list processing to continue. If no TD is found on the control list, and if the HCD does not set CLF, then CLF is still logic 0 when the Host Controller completes processing the control list and the control list processing stops.</p>
0	HCR	<p>Host Controller Reset: This bit is set by the HCD to initiate a software reset of the Host Controller. Regardless of the functional state of the Host Controller, it moves to the USB SUSPEND state in which most of the operational registers are reset, except those stated otherwise; for example, the IR (Interrupt Routing) field of HcControl, and no host bus accesses are allowed. This bit is cleared by the Host Controller on completing the reset operation. The reset operation must be completed within 10 μs. This bit, when set, must not cause a reset to the root hub and no subsequent reset signaling must be asserted to its downstream ports.</p>

11.1.4 HcInterruptStatus register (address: content of the base address register + 0Ch)

This is a 4-byte register that provides the status of the events that cause hardware interrupts. The bit allocation of the register is given in [Table 49](#). When an event occurs, the Host Controller sets the corresponding bit in this register. When a bit becomes set, a hardware interrupt is generated if the interrupt is enabled in the HcInterruptEnable register (see [Table 51](#)) and the MIE (Master Interrupt Enable) bit is set. The HCD may clear specific bits in this register by writing logic 1 to the bit positions to be cleared. The HCD may not set any of these bits. The Host Controller does not clear the bit.

Table 49. HcInterruptStatus register: bit allocation

Bit	31	30	29	28	27	26	25	24
Symbol	reserved	OC				reserved		
Reset	0	0	0	0	0	0	0	0
Access	-	R/W	-	-	-	-	-	-
Bit	23	22	21	20	19	18	17	16
Symbol								reserved
Reset	0	0	0	0	0	0	0	0
Access	-	-	-	-	-	-	-	-
Bit	15	14	13	12	11	10	9	8
Symbol								reserved
Reset	0	0	0	0	0	0	0	0
Access	-	-	-	-	-	-	-	-

Bit	7	6	5	4	3	2	1	0
Symbol	reserved	RHSC	FNO	UE	RD	SF	WDH	SO
Reset	0	0	0	0	0	0	0	0
Access	-	R/W	R/W	R/W	R/W	R/W	R/W	R/W

Table 50. HcInterruptStatus register: bit description

Bit	Symbol	Description
31	-	reserved
30	OC	Ownership Change: This bit is set by the Host Controller when HCD sets the OCR (Ownership Change Request) field in HcCommandStatus. This event, when unmasked, will always immediately generate a System Management Interrupt (SMI). This bit is forced to logic 0 when the SMI# pin is not implemented.
29 to 7	-	reserved
6	RHSC	Root Hub Status Change: This bit is set when the content of HcRhStatus or the content of any of HcRhPortStatus[NumberOfDownstreamPort] has changed.
5	FNO	Frame Number Overflow: This bit is set when the Most Significant Bit (MSB) of HcFmNumber (bit 15) changes value, or after the HccaFrameNumber is updated.
4	UE	Unrecoverable Error: This bit is set when the Host Controller detects a system error not related to USB. The Host Controller must not proceed with any processing nor signaling before the system error is corrected. The HCD clears this bit after the Host Controller is reset.
3	RD	Resume Detected: This bit is set when the Host Controller detects that a device on the USB is asserting resume signaling. It is the transition from no resume signaling to resume signaling causing this bit to be set. This bit is not set when the HCD sets the USBRESUME state.
2	SF	Start-of-Frame: At the start of each frame, this bit is set by the Host Controller and an SOF token is generated at the same time.
1	WDH	Write-back Done Head: This bit is immediately set after the Host Controller has written HcDoneHead to HccaDoneHead. Further, updates of HccaDoneHead occur only after this bit is cleared. The HCD must only clear this bit after it has saved the content of HccaDoneHead.
0	SO	Scheduling Overrun: This bit is set when USB schedules for current frame overruns and after the update of HccaFrameNumber. A scheduling overrun causes the SOC (Scheduling Overrun Count) of HcCommandStatus to be incremented.

11.1.5 HcInterruptEnable register (address: content of the base address register + 10h)

Each enable bit in the HcInterruptEnable register corresponds to an associated interrupt bit in the HcInterruptStatus register. The HcInterruptEnable register is used to control which events generate a hardware interrupt. If the following conditions occur:

- A bit is set in the HcInterruptStatus register.
- The corresponding bit in the HcInterruptEnable register is set.
- The MIE (Master Interrupt Enable) bit is set.

Then, a hardware interrupt is requested on the host bus.

Writing logic 1 to a bit in this register sets the corresponding bit, whereas writing logic 0 to a bit in this register leaves the corresponding bit unchanged. On a read, the current value of this register is returned.

The bit allocation is given in [Table 51](#).

Table 51. HcInterruptEnable register: bit allocation

Bit	31	30	29	28	27	26	25	24
Symbol	MIE	OC	reserved					
Reset	0	0	0	0	0	0	0	0
Access	R/W	R/W	-	-	-	-	-	-
Bit	23	22	21	20	19	18	17	16
Symbol	reserved							
Reset	0	0	0	0	0	0	0	0
Access	-	-	-	-	-	-	-	-
Bit	15	14	13	12	11	10	9	8
Symbol	reserved							
Reset	0	0	0	0	0	0	0	0
Access	-	-	-	-	-	-	-	-
Bit	7	6	5	4	3	2	1	0
Symbol	reserved	RHSC	FNO	UE	RD	SF	WDH	SO
Reset	0	0	0	0	0	0	0	0
Access	-	R/W	R/W	R/W	R/W	R/W	R/W	R/W

Table 52. HcInterruptEnable register: bit description

Bit	Symbol	Description
31	MIE	Master Interrupt Enable: 0 — Ignore 1 — Enables interrupt generation by events specified in other bits of this register
30	OC	Ownership Change: 0 — Ignore 1 — Enables interrupt generation because of ownership change
29 to 7	-	reserved
6	RHSC	Root Hub Status Change: 0 — Ignore 1 — Enables interrupt generation because of root hub status change
5	FNO	Frame Number Overflow: 0 — Ignore 1 — Enables interrupt generation because of frame number overflow
4	UE	Unrecoverable Error: 0 — Ignore 1 — Enables interrupt generation because of unrecoverable error

Table 52. HcInterruptEnable register: bit description ...continued

Bit	Symbol	Description
3	RD	Resume Detect: 0 — Ignore 1 — Enables interrupt generation because of resume detect
2	SF	Start-of-Frame: 0 — Ignore 1 — Enables interrupt generation because of Start-of-Frame
1	WDH	HcDoneHead Write-back: 0 — Ignore 1 — Enables interrupt generation because of HcDoneHead write-back
0	SO	Scheduling Overrun: 0 — Ignore 1 — Enables interrupt generation because of scheduling overrun

11.1.6 HcInterruptDisable register (address: content of the base address register + 14h)

Each disable bit in the HcInterruptDisable register corresponds to an associated interrupt bit in the HcInterruptStatus register. The HcInterruptDisable register is coupled with the HcInterruptEnable register. Therefore, writing logic 1 to a bit in this register clears the corresponding bit in the HcInterruptEnable register, whereas writing logic 0 to a bit in this register leaves the corresponding bit in the HcInterruptEnable register unchanged. On a read, the current value of the HcInterruptEnable register is returned. The register contains 4 bytes, and the bit allocation is given in [Table 53](#).

Table 53. HcInterruptDisable register: bit allocation

Bit	31	30	29	28	27	26	25	24
Symbol	MIE	OC	reserved					
Reset	0	0	0	0	0	0	0	0
Access	R/W	R/W	-	-	-	-	-	-
Bit	23	22	21	20	19	18	17	16
Symbol	reserved							
Reset	0	0	0	0	0	0	0	0
Access	-	-	-	-	-	-	-	-
Bit	15	14	13	12	11	10	9	8
Symbol	reserved							
Reset	0	0	0	0	0	0	0	0
Access	-	-	-	-	-	-	-	-
Bit	7	6	5	4	3	2	1	0
Symbol	reserved	RHSC	FNO	UE	RD	SF	WDH	SO
Reset	0	0	0	0	0	0	0	0
Access	-	R/W	R/W	R/W	R/W	R/W	R/W	R/W

Table 54. HcInterruptDisable register: bit description

Bit	Symbol	Description
31	MIE	Master Interrupt Enable: 0 — Ignore 1 — Disables interrupt generation because of events specified in other bits of this register. This field is set after a hardware or software reset. Interrupts are disabled.
30	OC	Ownership Change: 0 — Ignore 1 — Disables interrupt generation because of ownership change
29 to 7	-	reserved
6	RHSC	Root Hub Status Change: 0 — Ignore 1 — Disables interrupt generation because of root hub status change
5	FNO	Frame Number Overflow: 0 — Ignore 1 — Disables interrupt generation because of frame number overflow
4	UE	Unrecoverable Error: 0 — Ignore 1 — Disables interrupt generation because of unrecoverable error
3	RD	Resume Detect: 0 — Ignore 1 — Disables interrupt generation because of resume detect
2	SF	Start-of-Frame: 0 — Ignore 1 — Disables interrupt generation because of Start-of-Frame
1	WDH	HcDoneHead Write-back: 0 — Ignore 1 — Disables interrupt generation because of HcDoneHead write-back
0	SO	Scheduling Overrun: 0 — Ignore 1 — Disables interrupt generation because of scheduling overrun

11.1.7 HcHCCA register (address: content of the base address register + 18h)

The HcHCCA register contains the physical address of Host Controller Communication Area (HCCA). The bit allocation is given in [Table 55](#). The HCD determines alignment restrictions by writing all 1s to HcHCCA and reading the content of HcHCCA. The alignment is evaluated by examining the number of zeroes in the lower order bits. The minimum alignment is 256 bytes; therefore, bits 0 through 7 will always return logic 0 when read. This area is used to hold control structures and the Interrupt table that are accessed by both the Host Controller and the HCD.

Table 55. HcHCCA register: bit allocation

Bit	31	30	29	28	27	26	25	24
Symbol	HCCA[23:16]							
Reset	0	0	0	0	0	0	0	0
Access	R/W	R/W	R/W	R/W	R/W	R/W	R/W	R/W
Bit	23	22	21	20	19	18	17	16
Symbol	HCCA[15:8]							
Reset	0	0	0	0	0	0	0	0
Access	R/W	R/W	R/W	R/W	R/W	R/W	R/W	R/W
Bit	15	14	13	12	11	10	9	8
Symbol	HCCA[7:0]							
Reset	0	0	0	0	0	0	0	0
Access	R/W	R/W	R/W	R/W	R/W	R/W	R/W	R/W
Bit	7	6	5	4	3	2	1	0
Symbol	reserved							
Reset	0	0	0	0	0	0	0	0
Access	-	-	-	-	-	-	-	-

Table 56. HcHCCA register: bit description

Bit	Symbol	Description
31 to 8	HCCA[23:0]	Host Controller Communication Area Base Address: This is the base address of the HCCA.
7 to 0	-	reserved

11.1.8 HcPeriodCurrentED register (address: content of the base address register + 1Ch)

The HcPeriodCurrentED register contains the physical address of the current isochronous or interrupt ED. [Table 57](#) gives the bit allocation of the register.

Table 57. HcPeriodCurrentED register: bit allocation

Bit	31	30	29	28	27	26	25	24
Symbol	PCED[27:20]							
Reset	0	0	0	0	0	0	0	0
Access	R	R	R	R	R	R	R	R
Bit	23	22	21	20	19	18	17	16
Symbol	PCED[19:12]							
Reset	0	0	0	0	0	0	0	0
Access	R	R	R	R	R	R	R	R
Bit	15	14	13	12	11	10	9	8
Symbol	PCED[11:4]							
Reset	0	0	0	0	0	0	0	0
Access	R	R	R	R	R	R	R	R

Bit	7	6	5	4	3	2	1	0
Symbol	PCED[3:0]				reserved			
Reset	0	0	0	0	0	0	0	0
Access	R	R	R	R	-	-	-	-

Table 58. HcPeriodCurrentED register: bit description

Bit	Symbol	Description
31 to 4	PCED[27:0]	Period Current ED: This is used by the Host Controller to point to the head of one of the periodic lists that must be processed in the current Frame. The content of this register is updated by the Host Controller after a periodic ED has been processed. The HCD may read the content in determining which ED is currently being processed at the time of reading.
3 to 0	-	reserved

11.1.9 HcControlHeadED register (address: content of the base address register + 20h)

The HcControlHeadED register contains the physical address of the first ED of the control list. The bit allocation is given in [Table 59](#).

Table 59. HcControlHeadED register: bit allocation

Bit	31	30	29	28	27	26	25	24
Symbol	CHED[27:20]							
Reset	0	0	0	0	0	0	0	0
Access	R	R	R	R	R	R	R	R
Bit	23	22	21	20	19	18	17	16
Symbol	CHED[19:12]							
Reset	0	0	0	0	0	0	0	0
Access	R	R	R	R	R	R	R	R
Bit	15	14	13	12	11	10	9	8
Symbol	CHED[11:4]							
Reset	0	0	0	0	0	0	0	0
Access	R	R	R	R	R	R	R	R
Bit	7	6	5	4	3	2	1	0
Symbol	CHED[3:0]				reserved			
Reset	0	0	0	0	0	0	0	0
Access	R	R	R	R	-	-	-	-

Table 60. HcControlHeadED register: bit description

Bit	Symbol	Description
31 to 4	CHED[27:0]	Control Head ED: The Host Controller traverses the control list, starting with the HcControlHeadED pointer. The content is loaded from HCCA during the initialization of the Host Controller.
3 to 0	-	reserved

11.1.10 HcControlCurrentED register (address: content of the base address register + 24h)

The HcControlCurrentED register contains the physical address of the current ED of the control list. The bit allocation is given in [Table 61](#).

Table 61. HcControlCurrentED register: bit allocation

Bit	31	30	29	28	27	26	25	24
Symbol	CCED[27:20]							
Reset	0	0	0	0	0	0	0	0
Access	R	R	R	R	R	R	R	R
Bit	23	22	21	20	19	18	17	16
Symbol	CCED[19:12]							
Reset	0	0	0	0	0	0	0	0
Access	R	R	R	R	R	R	R	R
Bit	15	14	13	12	11	10	9	8
Symbol	CCED[11:4]							
Reset	0	0	0	0	0	0	0	0
Access	R	R	R	R	R	R	R	R
Bit	7	6	5	4	3	2	1	0
Symbol	CCED[3:0]				reserved			
Reset	0	0	0	0	0	0	0	0
Access	R	R	R	R	-	-	-	-

Table 62. HcControlCurrentED register: bit description

Bit	Symbol	Description
31 to 4	CCED[27:0]	Control Current ED: This pointer is advanced to the next ED after serving the present. The Host Controller must continue processing the list from where it left off in the last frame. When it reaches the end of the control list, the Host Controller checks the CLF (Control List Filled) bit of HcCommandStatus. If set, it copies the content of HcControlHeadED to HcControlCurrentED and clears the bit. If not set, it does nothing. The HCD is allowed to modify this register only when the CLE (Control List Enable) bit of HcControl is cleared. When set, the HCD only reads the instantaneous value of this register. Initially, this is set to logic 0 to indicate the end of the control list.
3 to 0	-	reserved

11.1.11 HcBulkHeadED register (address: content of the base address register + 28h)

This is a 4-byte register, and the bit allocation is given in [Table 63](#). The register contains the physical address of the first ED of the bulk list.

Table 63. HcBulkHeadED register: bit allocation

Bit	31	30	29	28	27	26	25	24
Symbol	BHED[27:20]							
Reset	0	0	0	0	0	0	0	0
Access	R/W	R/W	R/W	R/W	R/W	R/W	R/W	R/W

Bit	23	22	21	20	19	18	17	16
Symbol	BHED[19:12]							
Reset	0	0	0	0	0	0	0	0
Access	R/W	R/W	R/W	R/W	R/W	R/W	R/W	R/W
Bit	15	14	13	12	11	10	9	8
Symbol	BHED[11:4]							
Reset	0	0	0	0	0	0	0	0
Access	R/W	R/W	R/W	R/W	R/W	R/W	R/W	R/W
Bit	7	6	5	4	3	2	1	0
Symbol	BHED[3:0]				reserved			
Reset	0	0	0	0	0	0	0	0
Access	R/W	R/W	R/W	R/W	-	-	-	-

Table 64. HcBulkHeadED register: bit description

Bit	Symbol	Description
31 to 4	BHED[27:0]	Bulk Head ED: The Host Controller traverses the bulk list starting with the HcBulkHeadED pointer. The content is loaded from HCCA during the initialization of the Host Controller.
3 to 0	-	reserved

11.1.12 HcBulkCurrentED register (address: content of the base address register + 2Ch)

This register contains the physical address of the current endpoint of the bulk list. Endpoints are ordered according to their insertion to the list because the bulk list must be served in a round-robin fashion. The bit allocation is given in [Table 65](#).

Table 65. HcBulkCurrentED register: bit allocation

Bit	31	30	29	28	27	26	25	24
Symbol	BCED[27:20]							
Reset	0	0	0	0	0	0	0	0
Access	R/W	R/W	R/W	R/W	R/W	R/W	R/W	R/W
Bit	23	22	21	20	19	18	17	16
Symbol	BCED[19:12]							
Reset	0	0	0	0	0	0	0	0
Access	R/W	R/W	R/W	R/W	R/W	R/W	R/W	R/W
Bit	15	14	13	12	11	10	9	8
Symbol	BCED[11:4]							
Reset	0	0	0	0	0	0	0	0
Access	R/W	R/W	R/W	R/W	R/W	R/W	R/W	R/W
Bit	7	6	5	4	3	2	1	0
Symbol	BCED[3:0]				reserved			
Reset	0	0	0	0	0	0	0	0
Access	R/W	R/W	R/W	R/W	-	-	-	-

Table 66. HcBulkCurrentED register: bit description

Bit	Symbol	Description
31 to 4	BCED[27:0]	Bulk Current ED: This is advanced to the next ED after the Host Controller has served the present ED. The Host Controller continues processing the list from where it left off in the last frame. When it reaches the end of the bulk list, the Host Controller checks the CLF (Control List Filled) bit of HcControl. If the CLF bit is not set, nothing is done. If the CLF bit is set, it copies the content of HcBulkHeadED to HcBulkCurrentED and clears the CLF bit. The HCD can only modify this register when the BLE (Bulk List Enable) bit of HcControl is cleared. When HcControl is set, the HCD reads the instantaneous value of this register. This is initially set to logic 0 to indicate the end of the bulk list.
3 to 0	-	reserved

11.1.13 HcDoneHead register (address: content of the base address register + 30h)

The HcDoneHead register contains the physical address of the last completed TD that was added to the done queue. In a normal operation, the HCD need not read this register because its content is periodically written to the HCCA. [Table 67](#) contains the bit allocation of the register.

Table 67. HcDoneHead register: bit allocation

Bit	31	30	29	28	27	26	25	24
Symbol	DH[27:20]							
Reset	0	0	0	0	0	0	0	0
Access	R/W	R/W	R/W	R/W	R/W	R/W	R/W	R/W
Bit	23	22	21	20	19	18	17	16
Symbol	DH[19:12]							
Reset	0	0	0	0	0	0	0	0
Access	R/W	R/W	R/W	R/W	R/W	R/W	R/W	R/W
Bit	15	14	13	12	11	10	9	8
Symbol	DH[11:4]							
Reset	0	0	0	0	0	0	0	0
Access	R/W	R/W	R/W	R/W	R/W	R/W	R/W	R/W
Bit	7	6	5	4	3	2	1	0
Symbol	DH[3:0]				reserved			
Reset	0	0	0	0	0	0	0	0
Access	R/W	R/W	R/W	R/W	-	-	-	-

Table 68. HcDoneHead register: bit description

Bit	Symbol	Description
31 to 4	DH[27:0]	Done Head: When a TD is completed, the Host Controller writes the content of HcDoneHead to the NextTD field of the TD. The Host Controller then overwrites the content of HcDoneHead with the address of this TD. This is set to logic 0 whenever the Host Controller writes the content of this register to HCCA.
3 to 0	-	reserved

11.1.14 HcFmInterval register (address: content of the base address register + 34h)

The HcFmInterval register contains a 14-bit value that indicates the bit time interval in a frame, that is, between two consecutive SOFs, and a 15-bit value indicating the full-speed maximum packet size that the Host Controller may transmit or receive, without causing a scheduling overrun. The HCD may carry out minor adjustment on the FI (Frame Interval) by writing a new value over the present at each SOF. This provides the possibility for the Host Controller to synchronize with an external clocking resource and to adjust any unknown local clock offset. The bit allocation of the register is given in [Table 69](#).

Table 69. HcFmInterval register: bit allocation

Bit	31	30	29	28	27	26	25	24
Symbol	FIT		FSMPS[14:8]					
Reset	0	0	0	0	0	0	0	0
Access	R/W	R/W	R/W	R/W	R/W	R/W	R/W	R/W
Bit	23	22	21	20	19	18	17	16
Symbol	FSMPS[7:0]							
Reset	0	0	0	0	0	0	0	0
Access	R/W	R/W	R/W	R/W	R/W	R/W	R/W	R/W
Bit	15	14	13	12	11	10	9	8
Symbol	reserved		FI[13:8]					
Reset	0	0	1	0	1	1	1	0
Access	-	-	R/W	R/W	R/W	R/W	R/W	R/W
Bit	7	6	5	4	3	2	1	0
Symbol	FI[7:0]							
Reset	1	1	0	1	1	1	1	1
Access	R/W	R/W	R/W	R/W	R/W	R/W	R/W	R/W

Table 70. HcFmInterval register: bit description

Bit	Symbol	Description
31	FIT	Frame Interval Toggle: The HCD toggles this bit whenever it loads a new value to Frame Interval.
30 to 16	FSMPS[14:0]	FS Largest Data Packet: This field specifies a value that is loaded into the largest data packet counter at the beginning of each frame. The counter value represents the largest amount of data in bits that can be sent or received by the Host Controller in a single transaction at any given time, without causing a scheduling overrun. The field value is calculated by the HCD.
15 to 14	-	reserved
13 to 0	FI[13:0]	Frame Interval: This specifies the interval between two consecutive SOFs in bit times. The nominal value is set to 11,999. The HCD must store the current value of this field before resetting the Host Controller because this causes the field to be reset the nominal value. The HCD can then restore the stored value on completing the reset sequence.

11.1.15 HcFmRemaining register (address: content of the base address register + 38h)

The HcFmRemaining register is a 14-bit down counter showing the bit time remaining in the current frame. [Table 71](#) contains the bit allocation of this four-byte register.

Table 71. HcFmRemaining register: bit allocation

Bit	31	30	29	28	27	26	25	24
Symbol	FRT	reserved						
Reset	0	0	0	0	0	0	0	0
Access	R/W	-	-	-	-	-	-	-
Bit	23	22	21	20	19	18	17	16
Symbol	reserved							
Reset	0	0	0	0	0	0	0	0
Access	-	-	-	-	-	-	-	-
Bit	15	14	13	12	11	10	9	8
Symbol	reserved		FR[13:8]					
Reset	0	0	0	0	0	0	0	0
Access	-	-	R/W	R/W	R/W	R/W	R/W	R/W
Bit	7	6	5	4	3	2	1	0
Symbol	FR[7:0]							
Reset	0	0	0	0	0	0	0	0
Access	R/W	R/W	R/W	R/W	R/W	R/W	R/W	R/W

Table 72. HcFmRemaining register: bit description

Bit	Symbol	Description
31	FRT	Frame Remaining Toggle: This bit is loaded from the FIT (Frame Interval Toggle) field of HcFmInterval whenever FR (Frame Remaining) reaches 0. This bit is used by the HCD for the synchronization between FI (Frame Interval) and FR.
30 to 14	-	reserved
13 to 0	FR[13:0]	Frame Remaining: This counter is decremented at each bit time. When it reaches 0, it is reset by loading the FI value specified in HcFmInterval at the next bit time boundary. When entering the USBOPERATIONAL state, the Host Controller reloads the content with the FI of HcFmInterval and uses the updated value from the next SOF.

11.1.16 HcFmNumber register (address: content of the base address register + 3Ch)

This register is a 16-bit counter, and the bit allocation is given in [Table 73](#). It provides a timing reference among events happening in the Host Controller and the HCD. The HCD may use the 16-bit value specified in this register and generate a 32-bit frame number without requiring frequent access to the register.

Table 73. HcFmNumber register: bit allocation

Bit	31	30	29	28	27	26	25	24
Symbol	reserved							
Reset	0	0	0	0	0	0	0	0
Access	-	-	-	-	-	-	-	-

Bit	23	22	21	20	19	18	17	16
Symbol	reserved							
Reset	0	0	0	0	0	0	0	0
Access	-	-	-	-	-	-	-	-
Bit	15	14	13	12	11	10	9	8
Symbol	reserved		FN[13:8]					
Reset	0	0	0	0	0	0	0	0
Access	-	-	R/W	R/W	R/W	R/W	R/W	R/W
Bit	7	6	5	4	3	2	1	0
Symbol	FN[7:0]							
Reset	0	0	0	0	0	0	0	0
Access	R/W	R/W	R/W	R/W	R/W	R/W	R/W	R/W

Table 74. HcFmNumber register: bit description

Bit	Symbol	Description
31 to 14	-	reserved
13 to 0	FN[13:0]	Frame Number: Incremented when HcFmRemaining is re-loaded. It must be rolled over to 0h after FFFFh. Automatically incremented when entering the USBOPERATIONAL state. The content is written to HCCA after the Host Controller has incremented Frame Number at each frame boundary and sent a SOF but before the Host Controller reads the first ED in that frame. After writing to HCCA, the Host Controller sets the SF (Start-of-Frame) in HcInterruptStatus.

11.1.17 HcPeriodicStart register (address: content of the base address register + 40h)

The HcPeriodicStart register has a 14-bit programmable value that determines when is the earliest time for the Host Controller to start processing the periodic list. The bit allocation is given in [Table 75](#).

Table 75. HcPeriodicStart register: bit allocation

Bit	31	30	29	28	27	26	25	24
Symbol	reserved							
Reset	0	0	0	0	0	0	0	0
Access	-	-	-	-	-	-	-	-
Bit	23	22	21	20	19	18	17	16
Symbol	reserved							
Reset	0	0	0	0	0	0	0	0
Access	-	-	-	-	-	-	-	-
Bit	15	14	13	12	11	10	9	8
Symbol	reserved		P_S[13:8]					
Reset	0	0	0	0	0	0	0	0
Access	-	-	R/W	R/W	R/W	R/W	R/W	R/W

Bit	7	6	5	4	3	2	1	0
Symbol	P_S[7:0]							
Reset	0	0	0	0	0	0	0	0
Access	R/W	R/W	R/W	R/W	R/W	R/W	R/W	R/W

Table 76. HcPeriodicStart register: bit description

Bit	Symbol	Description
31 to 14	-	reserved
13 to 0	P_S[13:0]	Periodic Start: After a hardware reset, this field is cleared. It is then set by the HCD during the Host Controller initialization. The value is calculated roughly as 10 % of the HcFmInterval. A typical value is 3E67h. When HcFmRemaining reaches the value specified, processing of the periodic lists have priority over control or bulk processing. The Host Controller, therefore, starts processing the interrupt list after completing the current control or bulk transaction that is in progress.

11.1.18 HcLSThreshold register (address: content of the base address register + 44h)

This register contains an 11-bit value used by the Host Controller to determine whether to commit to the transfer of a maximum of 8-byte low-speed packet before EOF. Neither the Host Controller nor the HCD can change this value. The bit allocation of the HcLSThreshold register is given in [Table 77](#).

Table 77. HcLSThreshold register: bit allocation

Bit	31	30	29	28	27	26	25	24
Symbol	reserved							
Reset	0	0	0	0	0	0	0	0
Access	-	-	-	-	-	-	-	-
Bit	23	22	21	20	19	18	17	16
Symbol	reserved							
Reset	0	0	0	0	0	0	0	0
Access	-	-	-	-	-	-	-	-
Bit	15	14	13	12	11	10	9	8
Symbol	reserved				LST[11:8]			
Reset	0	0	0	0	0	1	1	0
Access	-	-	-	-	R/W	R/W	R/W	R/W
Bit	7	6	5	4	3	2	1	0
Symbol	LST[7:0]							
Reset	0	0	1	0	1	0	0	0
Access	R/W	R/W	R/W	R/W	R/W	R/W	R/W	R/W

Table 78. HcLSThreshold register: bit description

Bit	Symbol	Description
31 to 12	-	reserved
11 to 0	LST[11:0]	LS Threshold: This field contains a value that is compared to the FR (Frame Remaining) field prior to initiating a low-speed transaction. The transaction is started only if FR ≥ this field. The value is calculated by the HCD, considering the transmission and set-up overhead.

11.1.19 HcRhDescriptorA register (address: content of the base address register + 48h)

The HcRhDescriptorA register is the first of two registers describing the characteristics of the root hub. Reset values are implementation-specific.

[Table 79](#) contains the bit allocation of the HcRhDescriptorA register.

Table 79. HcRhDescriptorA register: bit allocation

Bit	31	30	29	28	27	26	25	24
Symbol	POTPGT[7:0]							
Reset	1	1	1	1	1	1	1	1
Access	R/W	R/W	R/W	R/W	R/W	R/W	R/W	R/W
Bit	23	22	21	20	19	18	17	16
Symbol	reserved							
Reset	0	0	0	0	0	0	0	0
Access	-	-	-	-	-	-	-	-
Bit	15	14	13	12	11	10	9	8
Symbol	reserved			NOCP	OCPM	DT	NPS	PSM
Reset	0	0	0	0	1	0	0	1
Access	-	-	-	R/W	R/W	R	R/W	R/W
Bit	7	6	5	4	3	2	1	0
Symbol	NDP[7:0]							
Reset	0	0	0	0	0	0	X ^[1]	X ^[2]
Access	R	R	R	R	R	R	R	R

[1] X is 1 for OHCI1 (2P) and OHCI2 (2P); X is 0 for OHCI1 (1P) and OHCI2 (1P).

[2] X is 0 for OHCI1 (2P) and OHCI2 (2P); X is 1 for OHCI1 (1P) and OHCI2 (1P).

Table 80. HcRhDescriptorA register: bit description

Bit	Symbol	Description
31 to 24	POTPGT[7:0]	Power On To Power Good Time: This byte specifies the duration the HCD must wait before accessing a powered-on port of the root hub. It is implementation-specific. The unit of time is 2 ms. The duration is calculated as POTPGT × 2 ms.
23 to 13	-	reserved
12	NOCP	No Overcurrent Protection: This bit describes how the overcurrent status for root hub ports are reported. When this bit is cleared, the OCPM (Overcurrent Protection Mode) field specifies global or per-port reporting. 0 — Overcurrent status is reported collectively for all downstream ports 1 — No overcurrent protection supported
11	OCPM	Overcurrent Protection Mode: This bit describes how the overcurrent status for root hub ports are reported. At reset, this fields reflects the same mode as Power Switching Mode. This field is valid only if the NOCP field is cleared. 0 — Overcurrent status is collectively reported for all downstream ports 1 — Overcurrent status is reported on a per-port basis
10	DT	Device Type: This bit specifies that the root hub is not a compound device. The root hub is not permitted to be a compound device. This field must always read 0.
9	NPS	No Power Switching: This bit is used to specify whether power switching is supported or ports are always powered. It is implementation-specific. When this bit is cleared, the PSM (Power Switching Mode) field specifies global or per-port switching. 0 — Ports are power switched 1 — Ports are always powered on when the Host Controller is powered on
8	PSM	Power Switching Mode: This bit is used to specify how the power switching of root hub ports is controlled. It is implementation-specific. This field is only valid if the NPS field is cleared. 0 — All ports are powered at the same time. 1 — Each port is powered individually. This mode allows port power to be controlled by either the global switch or per-port switching. If the PPCM (Port Power Control Mask) bit is set, the port responds only to port power commands (Set/Clear Port Power). If the port mask is cleared, then the port is controlled only by the global power switch (Set/Clear Global Power).
7 to 0	NDP[7:0]	Number Downstream Ports: These bits specify the number of downstream ports supported by the root hub. It is implementation-specific. The minimum number of ports is 1. The maximum number of ports supported by OHCI is 15.

11.1.20 HcRhDescriptorB register (address: content of the base address register + 4Ch)

The HcRhDescriptorB register is the second of two registers describing the characteristics of the root hub. The bit allocation is given in [Table 81](#). These fields are written during initialization to correspond with the system implementation. Reset values are implementation-specific.

Table 81. HcRhDescriptorB register: bit allocation

Bit	31	30	29	28	27	26	25	24
Symbol	PPCM[15:8]							
Reset	0	0	0	0	0	0	0	0
Access	R/W	R/W	R/W	R/W	R	R/W	R/W	R/W
Bit	23	22	21	20	19	18	17	16
Symbol	PPCM[7:0]							
Reset	0	0	0	0	0	0	0	0
Access	R/W	R/W	R/W	R/W	R/W	R/W	R/W	R/W
Bit	15	14	13	12	11	10	9	8
Symbol	DR[15:8]							
Reset	0	0	0	0	0	0	0	0
Access	R/W	R/W	R/W	R/W	R/W	R/W	R/W	R/W
Bit	7	6	5	4	3	2	1	0
Symbol	DR[7:0]							
Reset	0	0	0	0	0	0	0	0
Access	R/W	R/W	R/W	R/W	R/W	R/W	R/W	R/W

Table 82. HcRhDescriptorB register: bit description

Bit	Symbol	Description
31 to 16	PPCM[15:0]	<p>Port Power Control Mask: Each bit indicates whether a port is affected by a global power control command when Power Switching Mode is set. When set, the power state of the port is only affected by per-port power control (Set/Clear Port Power). When cleared, the port is controlled by the global power switch (Set/Clear Global Power). If the device is configured to global switching mode (Power Switching Mode = 0), this field is not valid.</p> <p>Bit 0 — reserved</p> <p>Bit 1 — Ganged-power mask on port #1</p> <p>Bit 2 — Ganged-power mask on port #2</p>
15 to 0	DR[15:0]	<p>Device Removable: Each bit is dedicated to a port of the root hub. When cleared, the attached device is removable. When set, the attached device is not removable.</p> <p>Bit 0 — reserved</p> <p>Bit 1 — Device attached to port #1</p> <p>Bit 2 — Device attached to port #2</p>

11.1.21 HcRhStatus register (address: content of the base address register + 50h)

The HcRhStatus register is divided into two parts. The lower word of a DWORD represents the Hub Status field and the upper word represents the Hub Status Change field. Reserved bits must always be written as logic 0. [Table 83](#) contains the bit allocation of the register.

Table 83. HcRhStatus register: bit allocation

Bit	31	30	29	28	27	26	25	24
Symbol	CRWE	reserved						
Reset	0	0	0	0	0	0	0	0
Access	R/W	-	-	-	-	-	-	-
Bit	23	22	21	20	19	18	17	16
Symbol	reserved						CCIC	LPSC
Reset	0	0	0	0	0	0	0	0
Access	-	-	-	-	-	-	R/W	R/W
Bit	15	14	13	12	11	10	9	8
Symbol	DRWE	reserved						
Reset	0	0	0	0	0	0	0	0
Access	R/W	-	-	-	-	-	-	-
Bit	7	6	5	4	3	2	1	0
Symbol	reserved						OCI	LPS
Reset	0	0	0	0	0	0	0	0
Access	-	-	-	-	-	-	R	RW

Table 84. HcRhStatus register: bit description

Bit	Symbol	Description
31	CRWE	On write Clear Remote Wake-up Enable : Writing logic 1 clears DRWE (Device Remote Wake-up Enable). Writing logic 0 has no effect.
30 to 18	-	reserved
17	CCIC	Overcurrent Indicator Change : This bit is set by hardware when a change has occurred to the OCI (Overcurrent Indicator) field of this register. The HCD clears this bit by writing logic 1. Writing logic 0 has no effect.
16	LPSC	On read Local Power Status Change : The root hub does not support the local power status feature. Therefore, this bit is always logic 0. On write Set Global Power : In global power mode (Power Switching Mode = 0), logic 1 is written to this bit to turn on power to all ports (clear Port Power Status). In per-port power mode, it sets Port Power Status only on ports whose Port Power Control Mask bit is not set. Writing logic 0 has no effect.
15	DRWE	On read Device Remote Wake-up Enable : This bit enables the Connect Status Change bit as a resume event, causing a state transition USB_SUSPEND to USB_RESUME and setting the Resume Detected interrupt. 0 — Connect Status Change is not a remote wake-up event 1 — Connect Status Change is a remote wake-up event On write Set Remote Wake-up Enable : Writing logic 1 sets DRWE (Device Remote Wake-up Enable). Writing logic 0 has no effect.

Table 84. HcRhStatus register: bit description ...continued

Bit	Symbol	Description
14 to 2	-	reserved
1	OCI	Overcurrent Indicator: This bit reports overcurrent conditions when global reporting is implemented. When set, an overcurrent condition exists. When cleared, all power operations are normal. If the per-port overcurrent protection is implemented, this bit is always logic 0.
0	LPS	On read Local Power Status: The root hub does not support the local power status feature. Therefore, this bit is always read as logic 0. On write Clear Global Power: In global power mode (Power Switching Mode = 0), logic 1 is written to this bit to turn off power to all ports (clear Port Power Status). In per-port power mode, it clears Port Power Status only on ports whose Port Power Control Mask bit is not set. Writing logic 0 has no effect.

11.1.22 HcRhPortStatus[1:4] register (address: content of the base address register + 54h)

The HcRhPortStatus[1:4] register is used to control and report port events on a per-port basis. NumberOfDownstreamPort represents the number of HcRhPortStatus registers that are implemented in hardware. The lower word reflects the port status. The upper word reflects status change bits. Some status bits are implemented with special write behavior. If a transaction, token through handshake, is in progress when a write to change port status occurs, the resulting port status change is postponed until the transaction completes. Always write logic 0 to the reserved bits. The bit allocation of the register is given in [Table 85](#).

Table 85. HcRhPortStatus[1:4] register: bit allocation

Bit	31	30	29	28	27	26	25	24
Symbol	reserved							
Reset	0	0	0	0	0	0	0	0
Access	-	-	-	-	-	-	-	-
Bit	23	22	21	20	19	18	17	16
Symbol	reserved			PRSC	OCIC	PSSC	PESC	CSC
Reset	0	0	0	0	0	0	0	0
Access	-	-	-	R/W	R/W	R/W	R/W	R/W
Bit	15	14	13	12	11	10	9	8
Symbol	reserved						LSDA	PPS
Reset	0	0	0	0	0	0	0	0
Access	-	-	-	-	-	-	R/W	R/W
Bit	7	6	5	4	3	2	1	0
Symbol	reserved			PRS	POCI	PSS	PES	CCS
Reset	0	0	0	0	0	0	0	0
Access	-	-	-	R/W	R/W	R/W	R/W	R/W

Table 86. HCRhPortStatus[1:4] register: bit description

Bit	Symbol	Description
31 to 21	-	reserved
20	PRSC	<p>Port Reset Status Change: This bit is set at the end of the 10 ms port reset signal. The HCD can write logic 1 to clear this bit. Writing logic 0 has no effect.</p> <p>0 — Port reset is not complete 1 — Port reset is complete</p>
19	OCIC	<p>Port Overcurrent Indicator Change: This bit is valid only if overcurrent conditions are reported on a per-port basis. This bit is set when the root hub changes the POCI (Port Overcurrent Indicator) bit. The HCD can write logic 1 to clear this bit. Writing logic 0 has no effect.</p> <p>0 — No change in Port Overcurrent Indicator 1 — POCI has changed</p>
18	PSSC	<p>Port Suspend Status Change: This bit is set when the full resume sequence is completed. This sequence includes the 20 ms resume pulse, LS EOP and 3 ms re-synchronization delay. The HCD can write logic 1 to clear this bit. Writing logic 0 has no effect. This bit is also cleared when Reset Status Change is set.</p> <p>0 — Resume is not completed 1 — Resume is completed</p>
17	PESC	<p>Port Enable Status Change: This bit is set when hardware events cause the PES (Port Enable Status) bit to be cleared. Changes from the HCD writes do not set this bit. The HCD can write logic 1 to clear this bit. Writing logic 0 has no effect.</p> <p>0 — No change in PES 1 — Change in PES</p>
16	CSC	<p>Connect Status Change: This bit is set whenever a connect or disconnect event occurs. The HCD can write logic 1 to clear this bit. Writing logic 0 has no effect. If CCS (Current Connect Status) is cleared when a Set Port Reset, Set Port Enable or Set Port Suspend write occurs, this bit is set to force the driver to re-evaluate the connection status because these writes must not occur if the port is disconnected.</p> <p>0 — No change in CCS 1 — Change in CCS</p> <p>Remark: If the DeviceRemovable[NDP] bit is set, this bit is set only after a root hub reset to inform the system that the device is attached.</p>
15 to 10	-	reserved
9	LSDA	<p>On read Low-speed Device Attached: This bit indicates the speed of the device attached to this port. When set, a low-speed device is attached to this port. When cleared, a full-speed device is attached to this port. This field is valid only when the CCS is set.</p> <p>0 — Port is not suspended 1 — Port is suspended</p> <p>On write Clear Port Power: The HCD can clear the PPS (Port Power Status) bit by writing logic 1 to this bit. Writing logic 0 has no effect.</p>

Table 86. HCRhPortStatus[1:4] register: bit description ...continued

Bit	Symbol	Description
8	PPS	<p>On read Port Power Status: This bit reflects the port power status, regardless of the type of power switching implemented. This bit is cleared if an overcurrent condition is detected. The HCD can set this bit by writing Set Port Power or Set Global Power. The HCD can clear this bit by writing Clear Port Power or Clear Global Power. Power Switching Mode and PortPowerControlMask[NDP] determine which power control switches are enabled. In Global Switching mode (Power Switching Mode = 0), only Set/Clear Global Power controls this bit. In the per-port power switching (Power Switching Mode = 1), if the PortPowerControlMask[NDP] bit for the port is set, only Set/Clear Port Power commands are enabled. If the mask is not set, only Set/Clear Global Power commands are enabled.</p> <p>When port power is disabled, CCS (Current Connect Status), PES (Port Enable Status), PSS (Port Suspend Status) and PRS (Port Reset Status) must be reset.</p> <p>0 — Port power is off 1 — Port power is on</p> <p>On write Set Port Power: The HCD can write logic 1 to set the PPS (Port Power Status) bit. Writing logic 0 has no effect.</p> <p>Remark: This bit always reads logic1 if power switching is not supported.</p>
7 to 5	-	reserved
4	PRS	<p>On read Port Reset Status: When this bit is set by a write to Set Port Reset, port reset signaling is asserted. When reset is completed and PRSC (Port Reset Status Change) is set, this bit is cleared.</p> <p>0 — Port reset signal is not active 1 — Port reset signal is active</p> <p>On write Set Port Reset: The HCD can set the port reset signaling by writing logic 1 to this bit. Writing logic 0 has no effect. If CCS is cleared, this write does not set PRS (Port Reset Status) but instead sets CCS. This informs the driver that it attempted to reset a disconnected port.</p>
3	POCI	<p>On read Port Overcurrent Indicator: This bit is valid only when the root hub is configured to show overcurrent conditions are reported on a per-port basis. If the per-port overcurrent reporting is not supported, this bit is set to logic 0. If cleared, all power operations are normal for this port. If set, an overcurrent condition exists on this port.</p> <p>0 — No overcurrent condition 1 — Overcurrent condition detected</p> <p>On write Clear Suspend Status: The HCD can write logic 1 to initiate a resume. Writing logic 0 has no effect. A resume is initiated only if PSS (Port Suspend Status) is set.</p>

Table 86. HCRhPortStatus[1:4] register: bit description ...continued

Bit	Symbol	Description
2	PSS	<p>On read Port Suspend Status: This bit indicates whether the port is suspended or is in the resume sequence. It is set by a Set Suspend State write and cleared when PSSC (Port Suspend Status Change) is set at the end of the resume interval. This bit is not set if CCS (Current Connect Status) is cleared. This bit is also cleared when PRSC (Port Reset Status Change) is set at the end of the port reset or when the Host Controller is placed in the USBRESUME state. If an upstream resume is in progress, it will propagate to the Host Controller.</p> <p>0 — Port is not suspended 1 — Port is suspended</p> <p>On write Set Port Suspend: The HCD can set the PSS (Port Suspend Status) bit by writing logic 1 to this bit. Writing logic 0 has no effect. If CCS is cleared, this write does not set PSS; instead it sets CSS. This informs the driver that it attempted to suspend a disconnected port.</p>
1	PES	<p>On read Port Enable Status: This bit indicates whether the port is enabled or disabled. The root hub may clear this bit when an overcurrent condition, disconnect event, switched-off power or operational bus error is detected. This change also causes Port Enabled Status Change to be set. The HCD can set this bit by writing Set Port Enable and clear it by writing Clear Port Enable. This bit cannot be set when CCS (Current Connect Status) is cleared. This bit is also set on completing a port reset when Reset Status Change is set or on completing a port suspend when Suspend Status Change is set.</p> <p>0 — Port is disabled 1 — Port is enabled</p> <p>On write Set Port Enable: The HCD can set PES (Port Enable Status) by writing logic 1. Writing logic 0 has no effect. If CCS is cleared, this write does not set PES, but instead sets CSC (Connect Status Change). This informs the driver that it attempted to enable a disconnected port.</p>
0	CCS	<p>On read Current Connect Status: This bit reflects the current state of the downstream port.</p> <p>0 — No device connected 1 — Device connected</p> <p>On write Clear Port Enable: The HCD can write logic 1 to this bit to clear the PES (Port Enable Status) bit. Writing logic 0 has no effect. The CCS (Current Connect Status) bit, on read, is not affected by any write to Clear Port Enable.</p> <p>Remark: This bit always reads logic 1 when the attached device is nonremovable (DeviceRemoveable[NDP]).</p>

11.2 USB legacy support registers

The ISP1561 supports legacy keyboard and mouse. Four operational registers are used to provide the legacy support. Each of these registers is located on a 32-bit boundary. The offset of these registers is relative to the base address of the Host Controller operational registers with HceControl located at offset 100h.

Table 87. Legacy support registers

Offset	Register	Description
100h	HceControl	used to enable and control the emulation hardware and report various status information
104h	HceInput	emulation of the legacy Input Buffer register
108h	HceOutput	emulation of the legacy Output Buffer register in which the software writes keyboard and mouse data
10Ch	HceStatus	emulation of the legacy Status register

Table 88. Emulated registers

I/O address	Cycle type	Register Contents accessed or modified	Side effects
60h	IN	HceOutput	IN from port 60h sets OUT_FULL (bit 0) in HceStatus to logic 0
60h	OUT	HceInput	OUT to port 60h sets IN_FULL (bit 1) to logic 1 and CMD_DATA (bit 3) to logic 0 in HceStatus
64h	IN	HceStatus	IN from port 64h returns current value of HceStatus with no other side effect
64h	OUT	HceInput	OUT to port 64h sets IN_FULL to logic 0 and CMD_DATA to logic 1 in HceStatus

11.2.1 HceControl register (address: content of the base address register + 100h)

[Table 89](#) shows the bit allocation of the register.

Table 89. HceControl register: bit allocation

Bit	31	30	29	28	27	26	25	24
Symbol	reserved							
Reset	0	0	0	0	0	0	0	0
Access	-	-	-	-	-	-	-	-
Bit	23	22	21	20	19	18	17	16
Symbol	reserved							
Reset	0	0	0	0	0	0	0	0
Access	-	-	-	-	-	-	-	-
Bit	15	14	13	12	11	10	9	8
Symbol	reserved							A20S
Reset	0	0	0	0	0	0	0	0
Access	-	-	-	-	-	-	-	R/W
Bit	7	6	5	4	3	2	1	0
Symbol	IRQ12A	IRQ1A	GA20S	EIRQEN	IRQEN	C_P	EI	EE
Reset	0	0	0	0	0	0	0	0
Access	R/W	R/W	R/W	R/W	R/W	R/W	R	R/W

Table 90. HceControl register: bit description

Bit	Symbol	Description
31 to 9	-	reserved
8	A20S	A20 State: This bit indicates the current state of gate A20 on the keyboard controller. It is used to compare against value written to 60h when GA20S (Gate A20 Sequence) is active.
7	IRQ12A	IRQ12 Active: This bit indicates that a positive transition on IRQ12 from the keyboard controller has occurred. Writing logic 1 sets IRQ12 to logic 0 (inactive). Writing logic 0 to this bit has no effect.
6	IRQ1A	IRQ1 Active: This bit indicates that a positive transition on IRQ1 from the keyboard controller has occurred. Writing logic 1 sets IRQ1 to logic 0 (inactive). Writing logic 0 to this bit has no effect.
5	GA20S	Gate A20 Sequence: This bit is set by the Host Controller when a data value of D1h is written to I/O port 64h and cleared, on a write to I/O port 64h of any value other than D1h.
4	EIRQEN	External IRQ Enable: When this bit is set to logic 1, IRQ1 and IRQ12 from the keyboard controller cause an emulation interrupt. This bit is independent of the setting of the EE (Emulation Enable) bit in this register.
3	IRQEN	IRQ Enable: When this bit is set, the Host Controller generates IRQ1 or IRQ12 as long as the OUT_FULL (Output Full) bit in HceStatus is set to logic 1. If the AUX_OUT_FULL (Auxiliary Output Full) bit of HceStatus is logic 0, then IRQ1 is generated; if it is logic 1, then an IRQ12 is generated.
2	C_P	Character Pending: When this bit is set, an emulation interrupt is generated when the OUT_FULL (Output Full) bit of the HceStatus register is set to logic 0.
1	EI	Emulation Interrupt: This bit shows the emulation interrupt condition. 0 — Legacy emulation enabled 1 — Legacy emulation disabled
0	EE	Emulation Enable: When this bit is set to logic 1, the Host Controller is enabled for legacy emulation. The Host Controller decodes accesses to I/O registers 60h and 64h, and enables interrupts on IRQ1 or IRQ12, or both. The Host Controller also generates an emulation interrupt at appropriate times to invoke the emulation software.

11.2.2 HceInput register (address: content of the base address register + 104h)

The HceInput register is a 4-byte register, and the bit allocation is given in [Table 91](#). The I/O data that is written to ports 60h and 64h is captured in this register, when emulation is enabled. This register may directly be read or written by accessing it in the Host Controller’s operational register space. When directly accessed in a memory cycle, reads and writes of this register have no side effects.

Table 91. HceInput register: bit allocation

Bit	31	30	29	28	27	26	25	24
Symbol	reserved							
Reset	0	0	0	0	0	0	0	0
Access	-	-	-	-	-	-	-	-

Bit	23	22	21	20	19	18	17	16
Symbol	reserved							
Reset	0	0	0	0	0	0	0	0
Access	-	-	-	-	-	-	-	-
Bit	15	14	13	12	11	10	9	8
Symbol	reserved							
Reset	0	0	0	0	0	0	0	0
Access	-	-	-	-	-	-	-	-
Bit	7	6	5	4	3	2	1	0
Symbol	IN_DATA[7:0]							
Reset	0	0	0	0	0	0	0	0
Access	R/W	R/W	R/W	R/W	R/W	R/W	R/W	R/W

Table 92. HceInput register: bit description

Bit	Symbol	Description
31 to 8	-	reserved
7 to 0	IN_DATA[7:0]	Input Data: This register holds data that is written to I/O ports 60h or 64h.

11.2.3 HceOutput register (address: content of the base address register + 108h)

Data placed in this register by the emulation software is returned when I/O port 60h is read and emulation is enabled. On a read of this location, the OUT_FULL (Output Full) bit in HceStatus is set to logic 0. The bit allocation is given in [Table 93](#).

Table 93. HceOutput register: bit allocation

Bit	31	30	29	28	27	26	25	24
Symbol	reserved							
Reset	0	0	0	0	0	0	0	0
Access	-	-	-	-	-	-	-	-
Bit	23	22	21	20	19	18	17	16
Symbol	reserved							
Reset	0	0	0	0	0	0	0	0
Access	-	-	-	-	-	-	-	-
Bit	15	14	13	12	11	10	9	8
Symbol	reserved							
Reset	0	0	0	0	0	0	0	0
Access	-	-	-	-	-	-	-	-
Bit	7	6	5	4	3	2	1	0
Symbol	OUT_DATA[7:0]							
Reset	0	0	0	0	0	0	0	0
Access	R/W	R/W	R/W	R/W	R/W	R/W	R/W	R/W

Table 94. HceOutput register: bit description

Bit	Symbol	Description
31 to 8	-	reserved
7 to 0	OUT_DATA[7:0]	Output Data: This register holds the data that is returned when an I/O read of port 60h is requested by application software.

11.2.4 HceStatus register (address: content of the base address register + 10Ch)

The contents of the HceStatus register are returned on an I/O read of port 64h when emulation is enabled. Reads and writes of port 60h, and writes to port 64h can cause changes in this register. Emulation software can directly access this register through its memory address in the Host Controller’s operational register space. Accessing this register through its memory address produces no side effects. [Table 95](#) contains the bit allocation.

Table 95. HceStatus register: bit allocation

Bit	31	30	29	28	27	26	25	24
Symbol	reserved							
Reset	0	0	0	0	0	0	0	0
Access	-	-	-	-	-	-	-	-
Bit	23	22	21	20	19	18	17	16
Symbol	reserved							
Reset	0	0	0	0	0	0	0	0
Access	-	-	-	-	-	-	-	-
Bit	15	14	13	12	11	10	9	8
Symbol	reserved							
Reset	0	0	0	0	0	0	0	0
Access	-	-	-	-	-	-	-	-
Bit	7	6	5	4	3	2	1	0
Symbol	PARITY	TIMEOUT	AUX_OUT_FULL	INH_SW	CMD_DATA	FLAG	IN_FULL	OUT_FULL
Reset	0	0	0	0	0	0	0	0
Access	R/W	R/W	R/W	R/W	R/W	R/W	R/W	R/W

Table 96. HceStatus register: bit description

Bit	Symbol	Description
31 to 8	-	reserved
7	PARITY	Parity: This bit indicates parity error on keyboard and mouse data.
6	TIMEOUT	Time-out: This bit indicates a time-out.
5	AUX_OUT_FULL	Auxiliary Output Full: IRQ12 is asserted whenever this bit is set to logic 1, OUT_FULL (Output Full) is set to logic 1, and the IRQEN bit is set.
4	INH_SW	Inhibit Switch: This bit reflects the state of the keyboard inhibit switch. If set, the keyboard is active.
3	CMD_DATA	Cmd Data: The Host Controller sets this bit to logic 0 on an I/O write to port 60h and to logic 1 on an I/O write to port 64h.

Table 96. HceStatus register: bit description ...continued

Bit	Symbol	Description
2	FLAG	Flag: Nominally used as a system flag by software to indicate a warm or cold boot.
1	IN_FULL	Input Full: Except for the case of a gate A20 sequence, this bit is set to logic 1 on an I/O write to address 60h or 64h. While this bit is set to logic 1 and emulation is enabled, an emulation interrupt condition exists.
0	OUT_FULL	Output Full: The Host Controller sets this bit to logic 0 on a read of I/O port 60h. If IRQEN is set, AUX_OUT_FULL (Auxiliary Output Full) determines which IRQ is activated. While this bit is logic 0 and C_P (Character Pending) in HceControl is set to logic 1, an emulation interrupt condition exists.

11.3 EHCI controller capability registers

Other than the OHCI Host Controller, there are some registers in EHCI that define the capability of EHCI. The address range of these registers is located before the operational registers.

11.3.1 CAPLENGTH/HCVERSION register (address: content of the base address register + 00h)

The bit allocation of this 4-byte register is given in [Table 97](#).

Table 97. CAPLENGTH/HCVERSION register: bit allocation

Bit	31	30	29	28	27	26	25	24
Symbol	reserved							
Reset	0	0	0	0	0	0	0	0
Access	-	-	-	-	-	-	-	-
Bit	23	22	21	20	19	18	17	16
Symbol	HCVERSION[15:8]							
Reset	1	0	0	1	0	1	0	1
Access	R	R	R	R	R	R	R	R
Bit	15	14	13	12	11	10	9	8
Symbol	HCVERSION[7:0]							
Reset	0	0	0	0	0	0	0	0
Access	R	R	R	R	R	R	R	R
Bit	7	6	5	4	3	2	1	0
Symbol	CAPLENGTH[7:0]							
Reset	0	0	0	0	1	1	0	0
Access	R	R	R	R	R	R	R	R

Table 98. CAPLENGTH/HCIVERSION register: bit description

Bit	Symbol	Description
31 to 24	-	reserved
23 to 8	HCIVERSION [15:0]	Host Controller Interface Version Number: It contains a BCD encoded version number of the interface to which the Host Controller interface conforms.
7 to 0	CAPLENGTH [7:0]	Capability Register Length: This is used as an offset. It is added to the register base to find the beginning of the operational register space.

11.3.2 HCSPARAMS register (address: content of the base address register + 04h)

The Host Controller Structural Parameters (HCSPARAMS) register is a set of fields that are structural parameters. The bit allocation is given in [Table 99](#).

Table 99. HCSPARAMS register: bit allocation

Bit	31	30	29	28	27	26	25	24
Symbol	reserved							
Reset	0	0	0	0	0	0	0	0
Access	-	-	-	-	-	-	-	-
Bit	23	22	21	20	19	18	17	16
Symbol	DPN[3:0]			reserved			P_INDICATOR	
Reset	0	0	0	0	0	0	0	0
Access	R	R	R	R	-	-	-	R
Bit	15	14	13	12	11	10	9	8
Symbol	N_CC[3:0]			N_PCC[3:0]				
Reset	0	0	1	0	0	0	1	0
Access	R	R	R	R	R	R	R	R
Bit	7	6	5	4	3	2	1	0
Symbol	PRR	reserved		PPC	N_PORTS[3:0]			
Reset	0	0	0	1	0	1	0	0
Access	R	-	-	R	R	R	R	R

Table 100. HCSPARAMS register: bit description

Bit	Symbol	Description
31 to 24	-	reserved
23 to 20	DPN[3:0]	Debug Port Number: This field identifies which of the Host Controller ports is the debug port. A nonzero value in this field indicates the presence of a debug port. The value in this register must not be greater than N_PORTS.
19 to 17		reserved
16	P_INDICATOR	Port Indicators: This bit indicates whether the ports support port indicator control. When this bit is logic 1, the port status and control registers include a read/writable field to control the state of the port indicator.

Table 100. HCSPARAMS register: bit description ...continued

Bit	Symbol	Description
15 to 12	N_CC [3:0]	Number of Companion Controller: This field indicates the number of companion controllers associated with this Hi-Speed USB Host Controller. A value of zero in this field indicates there are no companion Host Controllers. Port-ownership hand-off is not supported. Only high-speed devices are supported on the Host Controller root ports. A value larger than zero in this field indicates there are companion Original USB Host Controller(s). Port-ownership hand-offs are supported.
11 to 8	N_PCC [3:0]	Number of Ports per Companion Controller: This field indicates the number of ports supported per companion Host Controller. It is used to indicate the port routing configuration to system software. For example, if N_PORTS has a value of 6 and N_CC has a value of 2, then N_PCC can have a value of 3. The convention is that the first N_PCC ports are assumed to be routed to companion controller 1, the next N_PCC ports to companion controller 2, and so on. In the previous example, N_PCC could have been 4, in which case the first four are routed to companion controller 1 and the last two are routed to companion controller 2. The number in this field must be consistent with N_PORTS and N_CC.
7	PRR	Port Routing Rules: This field indicates the method used to map ports to companion controllers. 0 — The first N_PCC ports are routed to the lowest numbered function companion Host Controller, the next N_PCC ports are routed to the next lowest function companion controller, and so on. 1 — The port routing is explicitly enumerated by the first N_PORTS elements of the HCSP-PORTROUTE array.
6 to 5	-	reserved
4	PPC	Port Power Control: This field indicates whether the Host Controller implementation includes port power control. Logic 1 indicates the port has port power switches. Logic 0 indicates the port does not have port power switches. The value of this field affects the functionality of the Port Power field in each port status and control register.
3 to 0	N_PORTS [3:0]	N_Ports: This field specifies the number of physical downstream ports implemented on this Host Controller. The value of this field determines how many port registers are addressable in the operational register space. Valid values are in the range of 1h to Fh. Logic 0 in this field is undefined.

11.3.3 HCCPARAMS register (address: content of the base address register + 08h)

The Host Controller Capability Parameters (HCCPARAMS) register is a 4-byte register, and the bit allocation is given in [Table 101](#).

Table 101. HCCPARAMS register: bit allocation

Bit	31	30	29	28	27	26	25	24
Symbol	reserved							
Reset	0	0	0	0	0	0	0	0
Access	-	-	-	-	-	-	-	-
Bit	23	22	21	20	19	18	17	16
Symbol	reserved							
Reset	0	0	0	0	0	0	0	0
Access	-	-	-	-	-	-	-	-

Bit	15	14	13	12	11	10	9	8
Symbol	reserved							
Reset	0	0	0	0	0	0	0	0
Access	-	-	-	-	-	-	-	-
Bit	7	6	5	4	3	2	1	0
Symbol	IST[3:0]			reserved			PFLF	64AC
Reset	0	0	0	1	0	0	1	0
Access	R	R	R	R	-	-	R	R

Table 102. HCCPARAMS register: bit description

Bit	Symbol	Description
31 to 8	-	reserved
7 to 4	IST[3:0]	Isochronous Scheduling Threshold: Default = implementation dependent. This field indicates, relative to the current position of the executing Host Controller, where software can reliably update the isochronous schedule. When IST[3] is logic 0, the value of the least significant three bits indicates the number of micro frames a Host Controller can hold a set of isochronous data structures, one or more, before flushing the state. When IST[3] is logic 1, then host software assumes the Host Controller may cache an isochronous data structure for an entire frame.
3 to 2	-	reserved
1	PFLF	Programmable Frame List Flag: Default = implementation dependent. If this bit is cleared, the system software must use a frame list length of 1024 elements with this Host Controller. The USBCMD register FLS (Frame List Size) field is a read-only register and must be cleared. If PFLF is set, the system software can specify and use a smaller frame list and configure the host through the USBCMD register FLS field. The frame list must always be aligned on a 4 kB page boundary to ensure that the frame list is always physically contiguous.
0	64AC	64-bit Addressing Capability: This field documents the addressing range capability. 0 — Data structures using 32-bit address memory pointers 1 — Data structures using 64-bit address memory pointers

11.4 Operational registers of enhanced USB Host Controller

11.4.1 USBCMD register (address: content of the base address register + 0Ch)

The USB Command (USBCMD) register indicates the command to be executed by the serial Host Controller. Writing to this register causes a command to be executed.

[Table 103](#) shows the USBCMD register bit allocation.

Table 103. USBCMD register: bit allocation

Bit	31	30	29	28	27	26	25	24
Symbol	reserved							
Reset	0	0	0	0	0	0	0	0
Access	-	-	-	-	-	-	-	-

Bit	23	22	21	20	19	18	17	16
Symbol	ITC[7:0]							
Reset	0	0	0	0	1	0	0	0
Access	R/W	R/W	R/W	R/W	R/W	R/W	R/W	R/W
Bit	15	14	13	12	11	10	9	8
Symbol	reserved							
Reset	0	0	0	0	0	0	0	0
Access	-	-	-	-	-	-	-	-
Bit	7	6	5	4	3	2	1	0
Symbol	LHCR	IAAD	ASE	PSE	FLS[1:0]		HC RESET	RS
Reset	0	0	0	0	0	0	0	0
Access	R/W	R/W	R/W	R/W	R/W	R/W	R/W	R/W

Table 104. USBCMD register: bit description

Bit	Symbol	Description
31 to 24	-	reserved
23 to 16	ITC[7:0]	<p>Interrupt Threshold Control: Default 08h. This field is used by system software to select the maximum rate at which the Host Controller will issue interrupts. If software writes an invalid value to this register, the results are undefined. Valid values are:</p> <p>00h — reserved</p> <p>01h — 1 micro frame</p> <p>02h — 2 micro frames</p> <p>04h — 4 micro frames</p> <p>08h — 8 micro frames (equals 1 ms)</p> <p>10h — 16 micro frames (equals 2 ms)</p> <p>20h — 32 micro frames (equals 4 ms)</p> <p>40h — 64 micro frames (equals 8 ms)</p> <p>Software modifications to this field while HCH (HC Halted) bit is zero results in undefined behavior.</p>
15 to 8	-	reserved
7	LHCR	<p>Light Host Controller Reset: This control bit is not required. It allows the driver software to reset the EHCI controller, without affecting the state of the ports or the relationship to the companion Host Controllers. If not implemented, a read of this field will always return zero. If implemented, on read:</p> <p>Logic 0 — Indicates the Light Host Controller Reset has completed and it is ready for the host software to re-initialize the Host Controller</p> <p>Logic 1 — Indicates the Light Host Controller Reset has not yet completed</p>

Table 104. USBCMD register: bit description ...continued

Bit	Symbol	Description
6	IAAD	Interrupt on Asynchronous Advance Doorbell: This bit is used as a doorbell by software to notify the Host Controller to issue an interrupt the next time it advances the asynchronous schedule. Software must write logic 1 to this bit to ring the doorbell. When the Host Controller has evicted all appropriate cached schedule states, it sets the IAA (Interrupt on Asynchronous Advance) status bit in the USBSTS register. If the IAAE (Interrupt on Asynchronous Advance Enable) bit in the USBINTR register is logic 1, then the Host Controller will assert an interrupt at the next interrupt threshold. The Host Controller sets this bit to logic 0 after it sets IAA (Interrupt on Asynchronous Advance) status bit in the USBSTS register. Software must not set this bit when the asynchronous schedule is inactive because this results in an undefined value.
5	ASE	Asynchronous Schedule Enable: Default = 0. This bit controls whether the Host Controller skips processing the asynchronous schedule. 0 — Do not process the asynchronous schedule 1 — Use the ASYNCLISTADDR register to access the asynchronous schedule
4	PSE	Periodic Schedule Enable: Default = 0. This bit controls whether the Host Controller skips processing the periodic schedule. 0 — Do not process the periodic schedule 1 — Use the PERIODICLISTBASE register to access the periodic schedule
3 to 2	FLS[1:0]	Frame List Size: Default = 00b. This field is read and write only if PFLF (bit 1) in the HCCPARAMS register is set to logic 1. This field specifies the size of the frame list. The size the frame list controls which bits in the Frame Index register must be used for the frame list current index. 00b — 1024 elements (4096 bytes) 01b — 512 elements (2048 bytes) 10b — 256 elements (1024 bytes) for small environments 11b — reserved
1	HC RESET	Host Controller Reset: This control bit is used by the software to reset the Host Controller. The effects of this on Root Hub registers are similar to a chip hardware reset. Setting this bit causes the Host Controller to reset its internal pipelines, timers, counters, state machines, and so on, to their initial values. Any transaction currently in progress on USB is immediately terminated. A USB reset is not driven on downstream ports. This reset does not affect PCI Configuration registers. All operational registers, including port registers and port state machines, are set to their initial values. Port ownership reverts to the companion Host Controller(s). The software must re-initialize the Host Controller to return it to an operational state. This bit is cleared by the Host Controller when the reset process is complete. Software cannot terminate the reset process early by writing logic 0 to this register. Software must check the HCH (HC Halted) bit in the USBSTS register is logic 0 before setting this bit. Attempting to reset an actively running Host Controller results in undefined behavior.
0	RS	Run/Stop: 1 = Run. 0 = Stop. When set, the Host Controller executes the schedule. The Host Controller continues execution as long as this bit is set. When this bit is cleared, the Host Controller completes the current and active transactions in the USB pipeline, and then halts. The HCH (HC Halted) bit in the USBSTS register indicates when the Host Controller has finished the transaction and has entered the stopped state. Software must check HCH (HC Halted) in the USBSTS register is logic 1, before setting this bit.

11.4.2 USBSTS register (address: content of the base address register + 10h)

The USB Status (USBSTS) register indicates pending interrupts and various states of the Host Controller. The status resulting from a transaction on the serial bus is not indicated in this register. Software clears the register bits by writing ones to them. The bit allocation is given in [Table 105](#).

Table 105. USBSTS register: bit allocation

Bit	31	30	29	28	27	26	25	24
Symbol	reserved							
Reset	0	0	0	0	0	0	0	0
Access	-	-	-	-	-	-	-	-
Bit	23	22	21	20	19	18	17	16
Symbol	reserved							
Reset	0	0	0	0	0	0	0	0
Access	-	-	-	-	-	-	-	-
Bit	15	14	13	12	11	10	9	8
Symbol	ASS	PSSTAT	RECL	HCH	reserved			
Reset	0	0	0	1	0	0	0	0
Access	R	R	R	R	-	-	-	-
Bit	7	6	5	4	3	2	1	0
Symbol	reserved		IAA	HSE	FLR	PCD	USB ERRINT	USBINT
Reset	0	0	0	0	0	0	0	0
Access	-	-	R	R/W	R/W	R/W	R/W	R/W

Table 106. USBSTS register: bit description

Bit	Symbol	Description
31 to 16	-	reserved
15	ASS	Asynchronous Schedule Status: 0 = Default. The bit reports the current real status of the asynchronous schedule. If this bit is logic 0, the status of the asynchronous schedule is disabled. If this bit is logic 1, the status of the asynchronous schedule is enabled. The Host Controller is not required to immediately disable or enable the asynchronous schedule when software changes the ASE (Asynchronous Schedule Enable) bit in the USBCMD register. When this bit and the ASE (Asynchronous Schedule Enable) bit have the same value, the asynchronous schedule is either enabled (1) or disabled (0).
14	PSSTAT	Periodic Schedule Status: 0 = Default. This bit reports the current status of the periodic schedule. If this bit is logic 0, the status of the periodic schedule is disabled. If this bit is logic 1, the status of the periodic schedule is enabled. The Host Controller is not required to immediately disable or enable the periodic schedule when software changes the PSE (Periodic Schedule Enable) bit in the USBCMD register. When this bit and the PSE bit have the same value, the periodic schedule is either enabled (1) or disabled (0).
13	RECL	Reclamation: 0 = Default. This is a read-only status bit that is used to detect an empty asynchronous schedule.

Table 106. USBSTS register: bit description ...continued

Bit	Symbol	Description
12	HCH	HC Halted: 1 = Default. This bit is logic 0 when the Run/Stop bit of the USBCMD register is logic 1. The Host Controller sets this bit to logic 1 after it has stopped executing because the Run/Stop bit is set to logic 0, either by software or by the Host Controller hardware. For example, on an internal error.
11 to 6	-	reserved
5	IAA	Interrupt on Asynchronous Advance: Default = 0. The system software can force the Host Controller to issue an interrupt the next time the Host Controller advances the asynchronous schedule by writing logic 1 to the IAAD (Interrupt on Asynchronous Advance Doorbell) bit in the USBCMD register. This status bit indicates the assertion of that interrupt source.
4	HSE	Host System Error: The Host Controller sets this bit when a serious error occurs during a host system access, involving the Host Controller module. In a PCI system, conditions that set this bit include PCI parity error, PCI master abort and PCI target abort. When this error occurs, the Host Controller clears the RS (Run/Stop) bit in the USBCMD register to prevent further execution of the scheduled TDs.
3	FLR	Frame List Rollover: The Host Controller sets this bit to logic 1 when the frame list index rolls over from its maximum value to zero. The exact value at which the rollover occurs depends on the frame list size. For example, if the frame list size (as programmed in the FLS (Frame List Size) field of the USBCMD register) is 1024 elements (see Table 111), the Frame Index register rolls over every time bit 13 of the FRINDEX register toggles. Similarly, if the size is 512 elements, the Host Controller sets this bit to logic 1 every time bit 12 of the FRINDEX register toggles.
2	PCD	Port Change Detect: The Host Controller sets this bit to logic 1 when any port, where the PO (Port Owner) bit is cleared, changes to logic 1, or a Force Port Resume bit changes to logic 1 as a result of a J-K transition detected on a suspended port. This bit is allowed to be maintained in the auxiliary power well. Alternatively, it is also acceptable that, on a D3-to-D0 transition of the EHCI Host Controller device, this bit is loaded with the logical OR of all of the PORTSC change bits, including force port resume, overcurrent change, enable or disable change, and connect status change.
1	USBERRINT	USB Error Interrupt: The Host Controller sets this bit when an error condition occurs because of completing a USB transaction. For example, error counter underflow. If the Transfer Descriptor (TD) on which the error interrupt occurred also had its IOC bit set, both this bit and USBINT bit are set.
0	USBINT	USB Interrupt: The Host Controller sets this bit on completing a USB transaction, which results in the retirement of a TD that had its IOC bit set. The Host Controller also sets this bit when a short packet is detected, that is, the actual number of bytes received was less than the expected number of bytes.

11.4.3 USBINTR register (address: content of the base address register + 14h)

The USB Interrupt Enable (USBINTR) register enables and disables reporting of the corresponding interrupt to the software. When a bit is set and the corresponding interrupt is active, an interrupt is generated to the host. Interrupt sources that are disabled in this register still appear in the USBSTS to allow the software to poll for events. The USBSTS register bit allocation is give in [Table 107](#).

Table 107. USBINTR register: bit allocation

Bit	31	30	29	28	27	26	25	24
Symbol	reserved							
Reset	0	0	0	0	0	0	0	0
Access	-	-	-	-	-	-	-	-
Bit	23	22	21	20	19	18	17	16
Symbol	reserved							
Reset	0	0	0	0	0	0	0	0
Access	-	-	-	-	-	-	-	-
Bit	15	14	13	12	11	10	9	8
Symbol	reserved							
Reset	0	0	0	0	0	0	0	0
Access	-	-	-	-	-	-	-	-
Bit	7	6	5	4	3	2	1	0
Symbol	reserved		IAAE	HSEE	FLRE	PCIE	USBERR INTE	USBINTE
Reset	0	0	0	0	0	0	0	0
Access	-	-	R/W	R/W	R/W	R/W	R/W	R/W

Table 108. USBINTR register: bit description

Bit	Symbol	Description
31 to 6	-	reserved
5	IAAE	Interrupt on Asynchronous Advance Enable: When this bit and the IAA (Interrupt on Asynchronous Advance) bit in the USBSTS register are set, the Host Controller issues an interrupt at the next interrupt threshold. The interrupt is acknowledged by software clearing bit IAA.
4	HSEE	Host System Error Enable: When this bit and the Host System Error Status bit in the USBSTS register are set, the Host Controller issues an interrupt. The interrupt is acknowledged by software clearing the HSE (Host System Error) bit.
3	FLRE	Frame List Rollover Enable: When this bit and the FLR (Frame List Rollover) bit in the USBSTS register are set, the Host Controller issues an interrupt. The interrupt is acknowledged by software clearing the FLR (Frame List Rollover) bit.

Table 108. USBINTR register: bit description ...continued

Bit	Symbol	Description
2	PCIE	Port Change Interrupt Enable: When this bit and the PCD (Port Change Detect) bit in the USBSTS register are set, the Host Controller issues an interrupt. The interrupt is acknowledged by software clearing the PCD (Port Change Detect) bit.
1	USBERRINTE	USB Error Interrupt Enable: When this bit and the USBERRINT bit in the USBSTS register are set, the Host Controller issues an interrupt at the next interrupt threshold. The interrupt is acknowledged by software clearing the USBERRINT bit.
0	USBINTE	USB Interrupt Enable: When this bit and the USBINT bit in the USBSTS register are set, the Host Controller issues an interrupt at the next interrupt threshold. The interrupt is acknowledged by software clearing the USBINT bit.

11.4.4 FRINDEX register (address: content of the base address register + 18h)

The Frame Index (FRINDEX) register is used by the Host Controller to index into the periodic frame list. The register updates every 125 μs, once each microframe. Bits N to 3 are used to select a particular entry in the periodic frame list during periodic schedule execution. The number of bits used for the index depends on the size of the frame list as set by system software in the FLS (Frame List Size) field in the USBCMD register. This register must be written as a DWORD. Byte writes produce undefined results. This register cannot be written unless the Host Controller is in the halted state, as indicated by the HCH (HC Halted) bit. A write to this register while the RS (Run/Stop) bit is set produces undefined results. Writes to this register also affect the SOF value. The bit allocation is given in [Table 109](#).

Table 109. FRINDEX register: bit allocation

Bit	31	30	29	28	27	26	25	24
Symbol	reserved							
Reset	0	0	0	0	0	0	0	0
Access	-	-	-	-	-	-	-	-
Bit	23	22	21	20	19	18	17	16
Symbol	reserved							
Reset	0	0	0	0	0	0	0	0
Access	-	-	-	-	-	-	-	-
Bit	15	14	13	12	11	10	9	8
Symbol	reserved		FRINDEX[13:8]					
Reset	0	0	0	0	0	0	0	0
Access	-	-	R/W	R/W	R/W	R/W	R/W	R/W
Bit	7	6	5	4	3	2	1	0
Symbol	FRINDEX[7:0]							
Reset	0	0	0	0	0	0	0	0
Access	R/W	R/W	R/W	R/W	R/W	R/W	R/W	R/W

Table 110. FRINDEX register: bit description

Bit	Symbol	Description
31 to 14	-	reserved
13 to 0	FRINDEX [13:0]	Frame Index: Bits in this register are used for the frame number in the SOF packet and as the index into the frame list. The value in this register increments at the end of each time frame. For example, micro frame. The bits used for the frame number in the SOF token are taken from bits 13 to 3 of this register. Bits N to 3 are used for the frame list current index. This means that each location of the frame list is accessed eight times, frames or micro frames, before moving to the next index. Table 111 illustrates N based on the value of the FLS (Frame List Size) field in the USBCMD register.

Table 111. N based value of FLS[1:0]

FLS[1:0]	Number elements	N
00b	1024	12
01b	512	11
10b	256	10
11b	reserved	-

11.4.5 CTRLDSSEGMENT register (address: content of the base address register + 1Ch)

The Control Data Structure Segment (CTRLDSSEGMENT) register corresponds to the most significant address bits (bits 63 to 32) for all EHCI data structures. If the 64AC (64-bit Addressing Capability) field in HCCPARAMS is cleared, then this register is not used and software cannot write to it (reading from this register returns zero).

If the 64AC (64-bit Addressing Capability) field in HCCPARAMS is set, this register is used with link pointers to construct 64-bit addresses to EHCI control data structures. This register is concatenated with the link pointer from either the PERIODICLISTBASE, ASYNCLISTADDR, or any control data structure link field to construct a 64-bit address.

This register allows the host software to locate all control data structures within the same 4 GB memory segment.

11.4.6 PERIODICLISTBASE register (address: content of the base address register + 20h)

The Periodic Frame List Base Address (PERIODICLISTBASE) register contains the beginning address of the periodic frame list in the system memory. If the Host Controller is in 64-bit mode, as indicated by logic 1 in the 64AC (64-bit Addressing Capability) field in the HCCPARAMS register, the most significant 32 bits of every control data structure address comes from the CTRLDSSEGMENT register. The system software loads this register before starting the schedule execution by the Host Controller. The memory structure referenced by this physical memory pointer is assumed as 4 kB aligned. The contents of this register are combined with the FRINDEX register to enable the Host Controller to step through the periodic frame list in sequence. The bit allocation is given in [Table 112](#).

Table 112. PERIODICLISTBASE register: bit allocation

Bit	31	30	29	28	27	26	25	24
Symbol	BA[19:12]							
Reset	0	0	0	0	0	0	0	0
Access	R/W	R/W	R/W	R/W	R/W	R/W	R/W	R/W
Bit	23	22	21	20	19	18	17	16
Symbol	BA[11:4]							
Reset	0	0	0	0	0	0	0	0
Access	R/W	R/W	R/W	R/W	R/W	R/W	R/W	R/W
Bit	15	14	13	12	11	10	9	8
Symbol	BA[3:0]				reserved			
Reset	0	0	0	0	0	0	0	0
Access	R/W	R/W	R/W	R/W	-	-	-	-
Bit	7	6	5	4	3	2	1	0
Symbol	reserved							
Reset	0	0	0	0	0	0	0	0
Access	-	-	-	-	-	-	-	-

Table 113. PERIODICLISTBASE register: bit description

Bit	Symbol	Description
31 to 12	BA[19:0]	Base Address: These bits correspond to memory address signals 31 to 12, respectively.
11 to 0	-	reserved

11.4.7 ASYNCLISTADDR register (address: content of the base address register + 24h)

This 32-bit register (bit allocation: [Table 114](#)) contains the address of the next asynchronous queue head to be executed. If the Host Controller is in 64-bit mode, as indicated by logic 1 in 64AC (64-bit Addressing Capability) field in the HCCPARAMS register, the most significant 32 bits of every control data structure address comes from the CTRLDSSEGMENT register. Bits 4 to 0 of this register always return zeros when read. The memory structure referenced by the physical memory pointer is assumed to be 32 bytes (cache aligned).

Table 114. ASYNCLISTADDR register: bit allocation

Bit	31	30	29	28	27	26	25	24
Symbol	LPL[26:19]							
Reset	0	0	0	0	0	0	0	0
Access	R/W	R/W	R/W	R/W	R/W	R/W	R/W	R/W
Bit	23	22	21	20	19	18	17	16
Symbol	LPL[18:11]							
Reset	0	0	0	0	0	0	0	0
Access	R/W	R/W	R/W	R/W	R/W	R/W	R/W	R/W

Bit	15	14	13	12	11	10	9	8
Symbol	LPL[10:3]							
Reset	0	0	0	0	0	0	0	0
Access	R/W	R/W	R/W	R/W	-	-	-	-
Bit	7	6	5	4	3	2	1	0
Symbol	LPL[2:0]			reserved				
Reset	0	0	0	0	0	0	0	0
Access	-	-	-	-	-	-	-	-

Table 115. ASYNCLISTADDR register: bit description

Bit	Symbol	Description
31 to 5	LPL[26:0]	Link Pointer List: These bits correspond to memory address signals 31 to 5, respectively. This field may only reference a Queue Head (QH).
4 to 0	-	reserved

11.4.8 CONFIGFLAG register (address: content of the base address register + 4Ch)

The bit allocation of the Configure Flag (CONFIGFLAG) register is given in [Table 116](#).

Table 116. CONFIGFLAG register: bit allocation

Bit	31	30	29	28	27	26	25	24
Symbol	reserved							
Reset	0	0	0	0	0	0	0	0
Access	-	-	-	-	-	-	-	-
Bit	23	22	21	20	19	18	17	16
Symbol	reserved							
Reset	0	0	0	0	0	0	0	0
Access	-	-	-	-	-	-	-	-
Bit	15	14	13	12	11	10	9	8
Symbol	reserved							
Reset	0	0	0	0	0	0	0	0
Access	-	-	-	-	-	-	-	-
Bit	7	6	5	4	3	2	1	0
Symbol	reserved							CF
Reset	0	0	0	0	0	0	0	0
Access	-	-	-	-	-	-	-	R/W

Table 117. CONFIGFLAG register: bit description

Bit	Symbol	Description
31 to 1	-	reserved
0	CF	<p>Configure Flag: The host software sets this bit as the last action in its process of configuring the Host Controller. This bit controls the default port-routing control logic.</p> <p>0 — Port routing control logic default-routes each port to an implementation dependent classic Host Controller</p> <p>1 — Port routing control logic default-routes all ports to this Host Controller</p>

11.4.9 PORTSC registers 1, 2, 3, 4 (address: content of the base address register + 50h + (4 times Port Number – 1)) where Port Number is 1, 2, 3,...N_Ports

The Port Status and Control (PORTSC) register (bit allocation: [Table 118](#)) is in the auxiliary power well. It is only reset by hardware when the auxiliary power is initially applied or in response to a Host Controller reset. The initial conditions of a port are:

- No device connected
- Port disabled

If the port has power control, software cannot change the state of the port until it sets port power bits. Software must not attempt to change the state of the port until power is stable on the port; maximum delay is 20 ms from the transition.

Table 118. PORTSC 1, 2, 3, 4 register: bit allocation

Bit	31	30	29	28	27	26	25	24
Symbol	reserved							
Reset	0	0	0	0	0	0	0	0
Access	-	-	-	-	-	-	-	-
Bit	23	22	21	20	19	18	17	16
Symbol	reserved	WKOC_E	WKDS CNNT_E	WKCNTT_ E	PTC[3:0]			
Reset	0	0	0	0	0	0	0	0
Access	-	R/W	R/W	R/W	R/W	R/W	R/W	R/W
Bit	15	14	13	12	11	10	9	8
Symbol	PIC[1:0]		PO	PP	LS[1:0]		reserved	PR
Reset	0	0	1	0	0	0	0	0
Access	R	R	R/W	R/W	R/W	R/W	-	R
Bit	7	6	5	4	3	2	1	0
Symbol	SUSP	FPR	OCC	OCA	PEDC	PED	ECSC	ECCS
Reset	0	0	0	0	0	0	0	0
Access	R/W	R/W	R	R	R/W	R/W	R/W	R

Table 119. PORTSC 1, 2, 3, 4 register: bit description

Bit	Symbol	Description
31 to 23	-	reserved
22	WKOC_E	Wake on Overcurrent Enable: Default = 0. Setting this bit enables the port to be sensitive to overcurrent conditions as wake-up events. [1]
21	WKDS CNNT_E	Wake on Disconnect Enable: Default = 0. Setting this bit enables the port to be sensitive to device disconnects as wake-up events. [1]
20	WKCNTT_ _E	Wake on Connect Enable: Default = 0. Setting this bit enables the port to be sensitive to device connects as wake-up events. [1]

Table 119. PORTSC 1, 2, 3, 4 register: bit description ...continued

Bit	Symbol	Description
19 to 16	PTC[3:0]	<p>Port Test Control: Default = 0000b. When this field is logic 0, the port is not operating in test mode. A nonzero value indicates that it is operating in test mode and test mode is indicated by the value. The encoding of test mode bits are:</p> <p>0000b — test mode disabled 0001b — test J_STATE 0010b — test K_STATE 0011b — test SE0_NAK 0100b — test packet 0101b — test FORCE_ENABLE 0110b to 1111b — reserved</p>
15 to 14	PIC[1:0]	<p>Port Indicator Control: Default = 0. Writing to this field has no effect if the P_INDICATOR bit in the HCSPARAMS register is logic 0. If P_INDICATOR bit is logic 1, then the bit encoding is:</p> <p>00b — Port indicators are off 01b — amber 10b — green 11b — undefined</p> <p>For a description on how these bits are implemented, refer to Ref. 8 “Universal Serial Bus Specification”.^[1]</p>
13	PO	<p>Port Owner: Default = 1. This bit unconditionally goes to logic 0 when the Configured bit in the CONFIGFLAG register makes logic 0 to logic 1 transition. This bit unconditionally goes to logic 1 whenever the Configured bit is logic 0. The system software uses this field to release ownership of the port to a selected Host Controller, if the attached device is not a high-speed device. Software writes logic 1 to this bit when the attached device is not a high-speed device. Logic 1 in this bit means that a companion Host Controller owns and controls the port.</p>
12	PP	<p>Port Power: The function of this bit depends on the value of the Port Power Control (PPC) field in the HCSPARAMS register.</p> <p>If PPC = 0 and PP = 1 — The Host Controller does not have port power control switches. Each port is hardwired to power.</p> <p>If PPC = 1 and PP = 1 or 0 — The Host Controller has port power control switches. This bit represents the current setting of the switch: logic 0 = off, logic 1 = on. When PP is logic 0, the port is nonfunctional and will not report any status</p> <p>When an overcurrent condition is detected on a powered port and PPC is logic 1, the PP bit in each affected port may be changed by the Host Controller from logic 1 to logic 0, removing power from the port.</p>
11 to 10	LS[1:0]	<p>Line Status: This field reflect the current logical levels of the DP (bit 11) and DM (bit 10) signal lines. These bits are used to detect low-speed USB devices before the port reset and enable sequence. This field is valid only when the Port Enable bit is logic 0, and the current connect status bit is set to logic 1.</p> <p>00b — SE0: Not a low-speed device, perform EHCI reset 01b — K-state: Low-speed device, release ownership of port 10b — J-state: Not a low-speed device, perform EHCI reset 11b — undefined: Not a low-speed device, perform EHCI reset.</p> <p>If Port Power (PP) is logic 0, this field is undefined.</p>

Table 119. PORTSC 1, 2, 3, 4 register: bit description ...continued

Bit	Symbol	Description
9	-	reserved
8	PR	<p>Port Reset: Logic 1 means the port is in reset. Logic 0 means the port is not in reset. Default = 0. When software sets this bit from logic 0, the bus reset sequence as defined in Ref. 8 “Universal Serial Bus Specification” is started. Software clears this bit to terminate the bus reset sequence. Software must hold this bit at logic 1 until the reset sequence, as specified in Ref. 8 “Universal Serial Bus Specification”, is completed.</p> <p>Remark: When software sets this bit, it must also clear the Port Enable bit.</p> <p>Remark: When software clears this bit, there may be a delay before the bit status changes to logic 0 because it will not read logic 0 until the reset is completed. If the port is in high-speed mode after reset is completed, the Host Controller will automatically enable this port; it can set the Port Enable bit. A Host Controller must terminate the reset and stabilize the state of the port within 2 ms of software changing this bit from logic 1 to logic 0. For example, if the port detects that the attached device is high-speed during a reset, then the Host Controller must enable the port within 2 ms of software clearing this bit.</p> <p>The HCH (HC Halted) bit in the USBSTS register must be logic 0 before software attempts to use this bit. The Host Controller may hold Port Reset asserted when the HCH (HC Halted) bit is set.^[1]</p>
7	SUSP	<p>Suspend: Default = 0. A logic 1 means the port is in the suspend state. A logic 0 means the Port is not suspended. The Port Enabled bit and the Suspend bit of this register define the port states as follows:</p> <p>PED = 0 and SUSP = x — Port is disabled</p> <p>PED = 1 and SUSP = 0 — Port is enabled</p> <p>PED = 1 and SUSP = 1 — Port is suspended</p> <p>When in the suspend state, downstream propagation of data is blocked on this port, except for the port reset. If a transaction was in progress when this bit was set, blocking occurs at the end of the current transaction. In the suspend state, the port is sensitive to resume detection. The bit status does not change until the port is suspended and there may be a delay in suspending a port, if there is a transaction currently in progress on USB. Attempts to clear this bit are ignored by the Host Controller. The Host Controller will unconditionally set this bit to logic 0 when:</p> <ul style="list-style-type: none"> • Software changes the FPR (Force Port Resume) bit to logic 0. • Software changes the PR (Port Reset) bit to logic 1. <p>If the host software sets this bit when the Port Enabled bit is logic 0, the results are undefined.^[1]</p>

Table 119. PORTSC 1, 2, 3, 4 register: bit description ...continued

Bit	Symbol	Description
6	FPR	Force Port Resume: Logic 1 means resume detected or driven on the port. Logic 0 means no resume (K-state) detected or driven on the port. Default = 0. Software sets this bit to drive the resume signaling. The Host Controller sets this bit if a J-to-K transition is detected while the port is in the suspend state. When this bit changes to logic 1 because a J-to-K transition is detected, the PCD (Port Change Detect) bit in the USBSTS register is also set to logic 1. If software sets this bit to logic 1, the Host Controller must not set the PCD (Port Change Detect) bit. When the EHCI controller owns the port, the resume sequence follows the sequence specified in Ref. 8 “Universal Serial Bus Specification” . The resume signaling (full-speed ‘K’) is driven on the port as long as this bit remains set. Software must time the resume and clear this bit after the correct amount of time has elapsed. Clearing this bit causes the port to return to high-speed mode, forcing the bus below the port into a high-speed idle. This bit will remain at logic 1, until the port has switched to the high-speed idle. The Host Controller must complete this transition within 2 ms of software clearing this bit. ^[1]
5	OCC	Overcurrent Change: Default = 0. This bit is set to logic 1 when there is a change in overcurrent active. Software clears this bit by setting this bit to logic 1.
4	OCA	Overcurrent Active: Default = 0. If set to logic 1, this port has an overcurrent condition. If set to logic 0, this port does not have an overcurrent condition. This bit will automatically change from logic 1 to logic 0 when the overcurrent condition is removed.
3	PEDC	Port Enable/Disable Change: Logic 1 means the port enabled/disabled status has changed. Logic 0 means no change. Default = 0. For the root hub, this bit gets set only when a port is disabled because of appropriate conditions existing at the EOF2 point. For definition of port error, refer to Chapter 11 of Ref. 8 “Universal Serial Bus Specification” . Software clears this bit by setting it. ^[1]
2	PED	Port Enabled/Disabled: Logic 1 means enable. Logic 0 means disable. Default = 0. Ports can only be enabled by the Host Controller as a part of the reset and enable sequence. Software cannot enable a port by writing logic 1 to this field. The Host Controller will only set this bit when the reset sequence determines that the attached device is a high-speed device. Ports can be disabled by either a fault condition or by host software. The bit status does not change until the port state has actually changed. There may be a delay in disabling or enabling a port because of other Host Controller and bus events. When the port is disabled, downstream propagation of data is blocked on this port, except for reset. ^[1]
1	ECSC	Connect Status Change: Logic 1 means change in ECCS (Current Connect Status). Logic 0 means no change. Default = 0. This bit indicates a change has occurred in the port’s ECCS (Current Connect Status). The Host Controller sets this bit for all changes to the port device connect status, even if system software has not cleared an existing connect status change. For example, the insertion status changes twice before system software has cleared the changed condition, hub hardware will be “setting” an already-set bit, that is, the bit will remain set. Software clears this bit setting it. ^[1]
0	ECCS	Current Connect Status: Logic 1 indicates a device is present on port. Logic 0 indicates no device is present. Default = 0. This value reflects the current state of the port and may not correspond directly to the event that caused the ECSC (Connect Status Change) bit to be set. ^[1]

[1] These fields read logic 0, if the Port Power (PP) (bit 12 in register PORTSC 1,2,3,4) is logic 0.

12. Current consumption

Table 120 shows the current consumption when two ports are active, that is, the SEL2PORTS pin is connected to V_{DD}.

Table 120. Current consumption when SEL2PORTS is HIGH

Cumulative current	Conditions	Typ	Unit
Total current on pins V _{AUX} plus AV _{AUX} plus AV _{AUX_PLL} plus V _{DD}	no devices connected to the ISP1561 ^[1]	151	mA
	one high-speed device connected to the ISP1561	181	mA
	two high-speed devices connected to the ISP1561	209	mA
Auxiliary current on pins V _{AUX} plus AV _{AUX} plus AV _{AUX_PLL}	no devices connected to the ISP1561 ^[1]	98	mA
	one high-speed device connected to the ISP1561	124	mA
	two high-speed devices connected to the ISP1561	153	mA
On pin V _{DD}	no devices connected to the ISP1561 ^[1]	53	mA
	one high-speed device connected to the ISP1561	56	mA
	two high-speed devices connected to the ISP1561	56	mA

[1] When one or two full-speed or low-speed power devices are connected, the current consumption is comparable with the current consumption when no high-speed devices are connected. There is a difference of approximately 1 mA.

Table 121 shows the current consumption when four ports are active, that is, the SEL2PORTS pin is connected to ground.

Table 121. Current consumption when SEL2PORTS is LOW

Cumulative current	Conditions	Typ	Unit
Total current on pins V _{AUX} plus AV _{AUX} plus AV _{AUX_PLL} plus V _{DD}	no devices connected to the ISP1561 ^[1]	207	mA
	one high-speed device connected to the ISP1561	236	mA
	two high-speed devices connected to the ISP1561	261	mA
	three high-speed devices connected to the ISP1561	288	mA
	four high-speed devices connected to the ISP1561	314	mA
Auxiliary current on pins V _{AUX} plus AV _{AUX} plus AV _{AUX_PLL}	no devices connected to the ISP1561 ^[1]	151	mA
	one high-speed device connected to the ISP1561	178	mA
	two high-speed devices connected to the ISP1561	206	mA
	three high-speed devices connected to the ISP1561	232	mA
	four high-speed devices connected to the ISP1561	259	mA
On pin AV _{AUX}	no devices connected to the ISP1561 ^[1]	7	mA
	one high-speed device connected to the ISP1561	33	mA
	two high-speed devices connected to the ISP1561	58	mA
	three high-speed devices connected to the ISP1561	84	mA
	four high-speed devices connected to the ISP1561	108	mA
On pin AV _{AUX_PLL}	no devices connected to the ISP1561	3	mA
	one high-speed device connected to the ISP1561	3	mA
	two high-speed devices connected to the ISP1561	3	mA
	three high-speed devices connected to the ISP1561	3	mA
	four high-speed devices connected to the ISP1561	3	mA

Table 121. Current consumption when SEL2PORTS is LOW ...continued

Cumulative current	Conditions	Typ	Unit
On pin V _{DD}	no devices connected to the ISP1561	56	mA
	one high-speed device connected to the ISP1561	57	mA
	two high-speed devices connected to the ISP1561	57	mA
	three high-speed devices connected to the ISP1561	57	mA
	four high-speed devices connected to the ISP1561	57	mA

[1] When one to four full-speed or low-speed power devices are connected, the current consumption is comparable with the current consumption when no high-speed devices are connected. There is a difference of only about 3 mA.

Table 122. Current consumption: S1 and S3

Current consumption	Typ	Unit
S1 ^[1]	130	mA
S3 ^[2]	1.5 ^[3]	mA
	0.52 ^[4]	mA

[1] S1 represents the system state that will determine the B1 and D1 states. For details, refer to [Ref. 5 "PCI Bus Power Management Interface Specification"](#).

[2] S3 represents the system state that will determine the B3 and D3 states. For details, refer to [Ref. 5 "PCI Bus Power Management Interface Specification"](#).

[3] When I²C-bus and legacy support are present.

[4] When I²C-bus and legacy support are not present.

13. Limiting values

Table 123. Limiting values

In accordance with the Absolute Maximum Rating System (IEC 60134).

Symbol	Parameter	Conditions	Min	Max	Unit
V_{DD}	supply voltage		-0.5	+4.6	V
V_{AUX}	auxiliary voltage		-0.5	+4.6	V
AV_{AUX}	analog auxiliary voltage (3.3 V); supply voltage		-0.5	+4.6	V
AV_{AUX_PLL}	analog auxiliary voltage (3.3 V); supply voltage for PLL		-0.5	+4.6	V
$V_{I(5V)}$	input voltage on 5 V buffers	$3.0\text{ V} < V_{DD} < 3.6\text{ V}$	[1] -0.5	+6.0	V
$V_{I(3.3V)}$	input voltage on 3.3 V buffers	$3.0\text{ V} < V_{DD} < 3.6\text{ V}$	-0.5	+4.6	V
I_{lu}	latch-up current	$V_I < 0\text{ V}$ or $V_I > V_{CC}$	-	100	mA
V_{esd}	electrostatic discharge voltage	all pins ($I_{LI} < 1\text{ }\mu\text{A}$)	-1000	+1000	V
		on pins DM1 to DM4, DP1 to DP4, and all GND pins ($I_{LI} < 1\text{ }\mu\text{A}$)	[2] -4000	+4000	V
T_{stg}	storage temperature		-40	+125	°C

[1] Valid only when the supply voltage is present.

[2] Test method available on request.

14. Recommended operating conditions

Table 124. Recommended operating conditions

Symbol	Parameter	Conditions	Min	Typ	Max	Unit
V_{DD}	supply voltage		3.0	3.3	3.6	V
V_{AUX}	auxiliary voltage		3.0	3.3	3.6	V
AV_{AUX}	analog auxiliary voltage (3.3 V); supply voltage		3.0	3.3	3.6	V
AV_{AUX_PLL}	analog auxiliary voltage (3.3 V); supply voltage for PLL		3.0	3.3	3.6	V
$V_{I(5V)}$	input voltage on 5 V buffers	[1] 0	0	-	5.5	V
$V_{I(3.3V)}$	input voltage on 3.3 V buffers		0	-	V_{DD}	V
T_{amb}	ambient temperature		-40	-	+85	°C
T_j	junction temperature		-40	-	+125	°C

[1] Valid only when the supply voltage is present.

15. Static characteristics

Table 125. Static characteristics: I²C-bus interface (SDA and SCL)

$V_{DD} = 3.0\text{ V to }3.6\text{ V}$; $T_{amb} = -40\text{ °C to }+85\text{ °C}$; unless otherwise specified.

Symbol	Parameter	Conditions	Min	Typ	Max	Unit
V _{IH}	HIGH-level input voltage		2.1	-	-	V
V _{IL}	LOW-level input voltage		-	-	0.9	V
V _{hys}	hysteresis voltage		0.15	-	-	V
V _{OL}	LOW-level output voltage	I _{OL} = 3 mA	-	-	0.4	V

Table 126. Static characteristics: digital pins

$V_{DD} = 3.0\text{ V to }3.6\text{ V}$; $T_{amb} = -40\text{ °C to }+85\text{ °C}$; unless otherwise specified.^[1]

Symbol	Parameter	Conditions	Min	Typ	Max	Unit
V _{IH}	HIGH-level input voltage		2.0	-	-	V
V _{IL}	LOW-level input voltage		-	-	0.8	V
V _{hys}	hysteresis voltage		0.4	-	0.7	V
V _{OL}	LOW-level output voltage	I _{OL} = 3 mA	-	-	0.4	V
V _{OH}	HIGH-level output voltage		2.4	-	-	V

[1] All pins are 5 V tolerant.

Table 127. Static characteristics: PCI interface block

$V_{DD} = 3.0\text{ V to }3.6\text{ V}$; $T_{amb} = -40\text{ °C to }+85\text{ °C}$; unless otherwise specified.^[1]

Symbol	Parameter	Conditions	Min	Typ	Max	Unit
V _{IH}	HIGH-level input voltage		2.0	-	5.5	V
V _{IL}	LOW-level input voltage		0	-	0.9	V
V _{IPU}	input pull-up voltage		2.1	-	-	V
I _{LI}	input leakage current	0 V < V _{IN} < V _{DD}	-10	-	+10	μA
V _{OH}	HIGH-level output voltage	I _{OUT} = 500 μA	2.7	-	-	V
V _{OL}	LOW-level output voltage	I _{OUT} = 1500 μA	-	-	0.3	V
C _{IN}	input pin capacitance		-	-	10	pF
C _{CLK}	CLK pin capacitance		5	-	12	pF
C _{IDSEL}	IDSEL pin capacitance		-	-	8	pF

[1] All pins are 5 V tolerant.

Table 128. Static characteristics: USB interface block (pins DM1 to DM4 and DP1 to DP4)

$V_{DD} = 3.0\text{ V to }3.6\text{ V}$; $T_{amb} = -40\text{ °C to }+85\text{ °C}$; unless otherwise specified.

Symbol	Parameter	Conditions	Min	Typ	Max	Unit
Input levels for high-speed						
V _{HSSQ}	high-speed squelch detection threshold voltage (differential signal amplitude)	squelch detected	-	-	100	mV
		no squelch detected	150	-	-	mV

Table 128. Static characteristics: USB interface block (pins DM1 to DM4 and DP1 to DP4) ...continued $V_{DD} = 3.0\text{ V to }3.6\text{ V}$; $T_{amb} = -40\text{ }^{\circ}\text{C to }+85\text{ }^{\circ}\text{C}$; unless otherwise specified.

Symbol	Parameter	Conditions	Min	Typ	Max	Unit
V_{HSDSC}	high-speed disconnect detection threshold voltage (differential signal amplitude)	disconnect detected	625	-	-	mV
		disconnect not detected	-	-	525	mV
V_{HSCM}	high-speed data signaling common mode voltage range (guideline for receiver)		-50	-	+500	mV
Output levels for high-speed						
V_{HSOI}	high-speed idle level voltage		-10	-	+10	mV
V_{HSOH}	high-speed data signaling HIGH-level voltage		360	-	440	mV
V_{HSOL}	high-speed data signaling LOW-level voltage		-10	-	+10	mV
V_{CHIRPJ}	chirp J level (differential voltage)		700 ^[1]	-	1100	mV
V_{CHIRPK}	chirp K level (differential voltage)		-900 ^[1]	-	-500	mV
Input levels for full-speed and low-speed						
V_{IH}	HIGH-level input voltage	drive	2.0	-	-	V
V_{IHZ}	HIGH-level input voltage (floating)		2.7	-	3.6	V
V_{IL}	LOW-level input voltage		-	-	0.8	V
V_{DI}	differential input sensitivity	$ V_{\text{DP}} - V_{\text{DM}} $	0.2	-	-	V
V_{CM}	differential common mode voltage range		0.8	-	2.5	V
Output levels for full-speed and low-speed						
V_{OH}	HIGH-level output voltage		2.8	-	3.6	V
V_{OL}	LOW-level output voltage		0	-	0.3	V
V_{OSE1}	SE1 output voltage		0.8	-	-	V
V_{CRS}	output signal crossover voltage		1.3	-	2.0	V

[1] HS termination resistor disabled, pull-up resistor connected. Only during reset, when both hub and device are capable of high-speed operation.

16. Dynamic characteristics

Table 129. Dynamic characteristics: system clock timing

$V_{DD} = 3.0\text{ V to }3.6\text{ V}$; $T_{amb} = -40\text{ }^{\circ}\text{C to }+85\text{ }^{\circ}\text{C}$; unless otherwise specified.

Symbol	Parameter	Conditions	Min	Typ	Max	Unit
Crystal oscillator						
f_{clk}	clock frequency	crystal ^[1]	^[2] -	12	-	MHz
		oscillator	-	48	-	MHz
External clock input						
δ	clock duty cycle		-	50	-	%
External clock input						
J	external clock jitter		-	-	50	ppm
t_{CR}	rise time		-	-	3	ns
t_{CF}	fall time		-	-	3	ns
δ_{clk}	clock duty factor		-	50	-	%
t_s	start-up time		-	5	10	ms

[1] Suggested values for external capacitors when using a crystal are 22 pF to 27 pF.

[2] Recommended accuracy of the clock frequency is 50 ppm for the crystal and oscillator. The oscillator should have 3.3 V power supply.

Table 130. Dynamic characteristics: I²C-bus interface (SDA and SCL)

$V_{DD} = 3.0\text{ V to }3.6\text{ V}$; $T_{amb} = -40\text{ }^{\circ}\text{C to }+85\text{ }^{\circ}\text{C}$; unless otherwise specified.^[1]

Symbol	Parameter	Conditions	Min	Typ	Max	Unit
t_f	fall time	$10\text{ pF} < C_B < 400\text{ pF}$ ^[2]	^[3] -	0	250	ns

[1] All pins are 5 V tolerant.

[2] The bus capacitance (C_B) is specified in pF. To meet the specification for V_{OL} and the maximum rise time (300 ns), use an external pull-up resistor with $R_{max} = 850 / C_B\text{ k}\Omega$ and $R_{min} = (V_{DD} - 0.4) / 3\text{ k}\Omega$.

[3] Output fall time V_{IH} to V_{IL} .

Table 131. Dynamic characteristics: PCI interface block

$V_{DD} = 3.0\text{ V to }3.6\text{ V}$; $T_{amb} = -40\text{ }^{\circ}\text{C to }+85\text{ }^{\circ}\text{C}$; unless otherwise specified.^[1]

Symbol	Parameter	Conditions	Min	Typ	Max	Unit
SR	slew rate	standard load ^[2]	^[3] 1	-	4	V/ns

[1] All pins are 5 V tolerant.

[2] Standard load is 10 pF together with a pull-up and pull-down resistor of 10 k Ω .

[3] Output slew rate (rise, fall).

Table 132. Dynamic characteristics: high-speed source electrical characteristics

$V_{DD} = 3.0\text{ V to }3.6\text{ V}$; $T_{amb} = -40\text{ }^{\circ}\text{C to }+85\text{ }^{\circ}\text{C}$; unless otherwise specified.

Symbol	Parameter	Conditions	Min	Typ	Max	Unit
Driver characteristics						
t_{HSR}	rise time (10 % to 90 %)		500	-	-	ps
t_{HSF}	fall time (10 % to 90 %)		500	-	-	ps

Table 132. Dynamic characteristics: high-speed source electrical characteristics ...continued

$V_{DD} = 3.0\text{ V to }3.6\text{ V}$; $T_{amb} = -40\text{ }^{\circ}\text{C to }+85\text{ }^{\circ}\text{C}$; unless otherwise specified.

Symbol	Parameter	Conditions	Min	Typ	Max	Unit
Z_{HSDRV}	driver output impedance (which also serves as high-speed termination)	includes the R_S resistor	40.5	45	49.5	Ω
Clock timing						
t_{HSDRAT}	high-speed data rate		479.76	-	480.24	Mb/s
t_{HSFRAM}	microframe interval		124.9375	-	125.0625	μs
t_{HSRFI}	consecutive microframe interval difference		1	-	four high-speed bit times	ns

Table 133. Dynamic characteristics: full-speed source electrical characteristics

$V_{DD} = 3.0\text{ V to }3.6\text{ V}$; $T_{amb} = -40\text{ }^{\circ}\text{C to }+85\text{ }^{\circ}\text{C}$; unless otherwise specified.

Symbol	Parameter	Conditions	Min	Typ	Max	Unit
Driver characteristics						
t_{FR}	rise time	$C_L = 50\text{ pF}$; 10 % to 90 % of $ V_{OH} - V_{OL} $	4	-	20	ns
t_{FF}	fall time	$C_L = 50\text{ pF}$; 90 % to 10 % of $ V_{OH} - V_{OL} $	4	-	20	ns
t_{FRFM}	differential rise and fall time matching		90	-	111.1	%
Z_{DRV}	driver output impedance for driver which is not high-speed capable		28	-	44	Ω
Data timing: see Figure 8						
t_{FDEOP}	source jitter for differential transition to SE0 transition	full-speed timing	-2	-	5	ns
t_{FEOPT}	source SE0 interval of EOP		160	-	175	ns
t_{FEOPR}	receiver SE0 interval of EOP		82	-	-	ns
t_{LDEOP}	upstream facing port source jitter for differential transition to SE0 transition	low-speed timing	-40	-	100	ns
t_{LEOPT}	source SE0 interval of EOP		1.25	-	1.5	μs
t_{LEOPR}	receiver SE0 interval of EOP		670	-	-	ns
t_{FST}	width of SE0 interval during differential transition		-	-	14	ns

Table 134. Dynamic characteristics: low-speed source electrical characteristics

$V_{DD} = 3.0\text{ V to }3.6\text{ V}$; $T_{amb} = -40\text{ }^{\circ}\text{C to }+85\text{ }^{\circ}\text{C}$; unless otherwise specified.

Symbol	Parameter	Conditions	Min	Typ	Max	Unit
Driver characteristics						
t_{LR}	transition time: rise time		75	-	300	ns
t_{LF}	transition time: fall time		75	-	300	ns
t_{LRFM}	rise and fall time matching		90	-	125	%

16.1 Timing

Table 135. PCI clock and IO timing

Symbol	Parameter	Conditions	Min	Typ	Max	Unit
PCI clock timing; see Figure 5						
T_{cyc}	CLK cycle time		30	-	32	ns
t_{high}	CLK HIGH time		11	-	-	ns
t_{low}	CLK LOW time		11	-	-	ns
SR_{CLK}	CLK slew rate		1	-	4	V/ns
$SR_{RST\#}$	RST# slew rate		50	-	-	mV/ns
PCI input timing; see Figure 6						
t_{su}	input set-up time to CLK - bused signals		7	-	-	ns
$t_{su(ptp)}$	input set-up time to CLK - point-to-point	[1]	10	-	-	ns
t_h	input hold time from CLK		0	-	-	ns
PCI output timing; see Figure 7						
t_{val}	CLK to signal valid delay time - bused signals		2	-	11	ns
$t_{val(ptp)}$	CLK to signal valid delay time - point-to-point	[1]	2	-	12	ns
t_{on}	float to active delay time		2	-	-	ns
t_{off}	active to float delay time		-	-	28	ns
PCI reset timing						
$t_{rst-clk}$	reset active time after CLK stable		100	-	-	μ s
t_{rst}	reset active time after power stable		1	-	-	ms

[1] REQ# and GNT# are point-to-point signals. GNT# has a setup of 10 ns; REQ# has a setup of 12 ns. All others are bus signals.

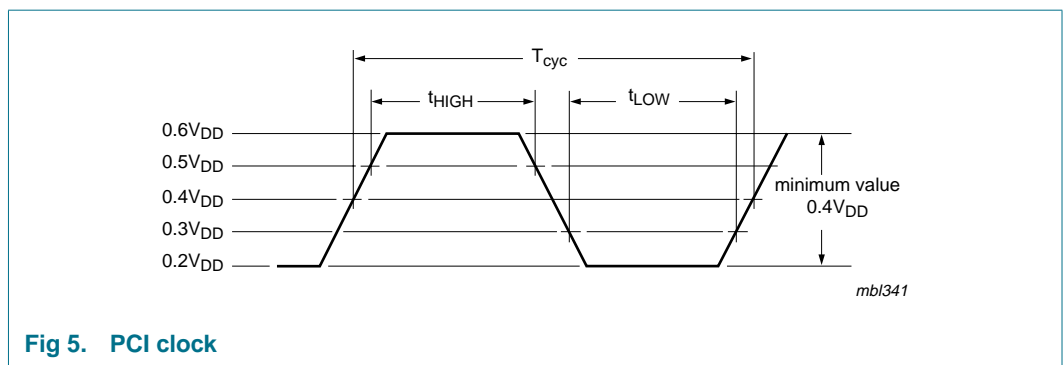

Fig 5. PCI clock

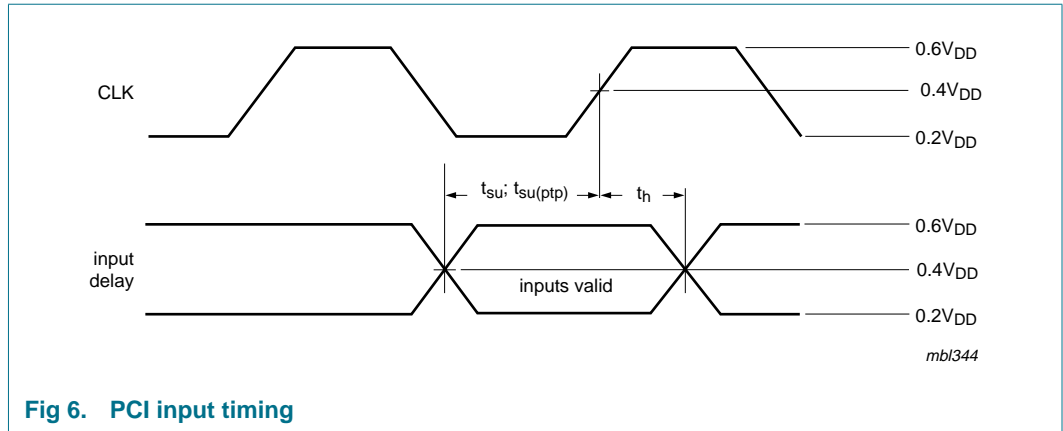

Fig 6. PCI input timing

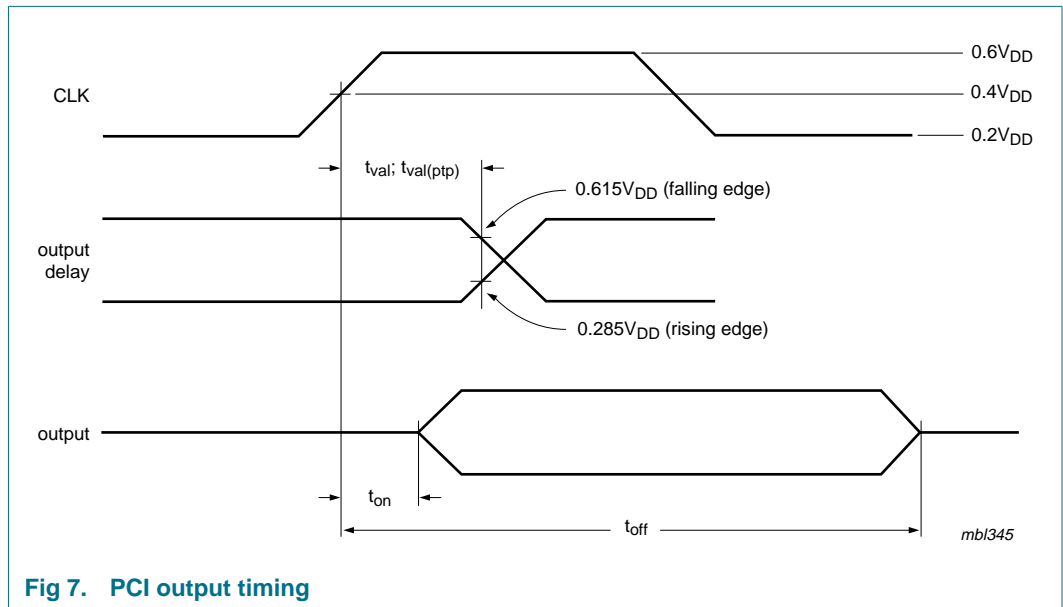
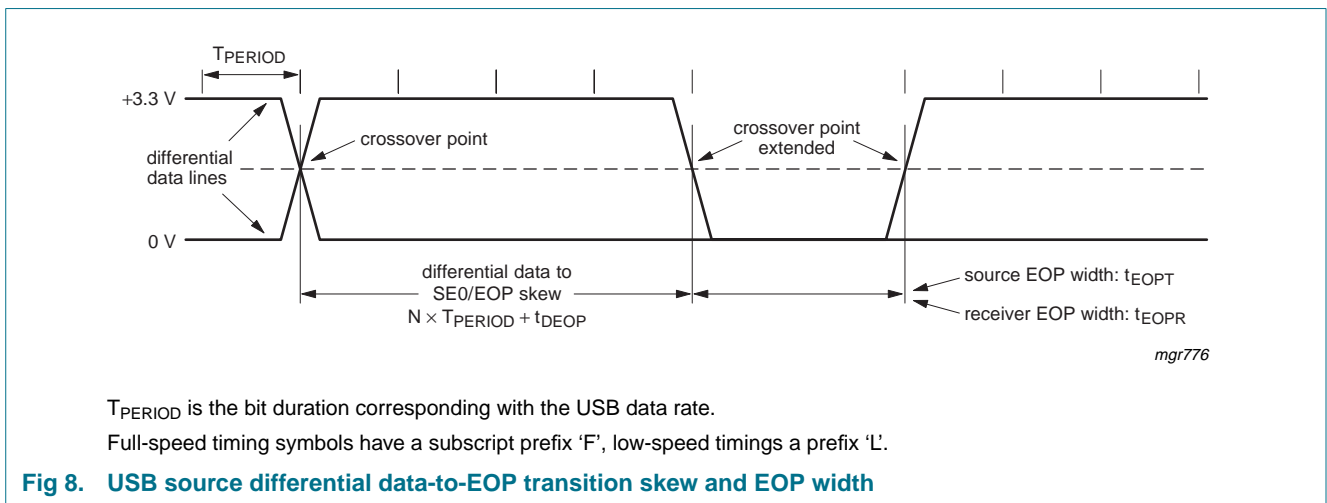

Fig 7. PCI output timing



T_{PERIOD} is the bit duration corresponding with the USB data rate.

Full-speed timing symbols have a subscript prefix 'F', low-speed timings a prefix 'L'.

Fig 8. USB source differential data-to-EOP transition skew and EOP width

17. Package outline

LQFP128: plastic low profile quad flat package; 128 leads; body 14 x 14 x 1.4 mm

SOT420-1

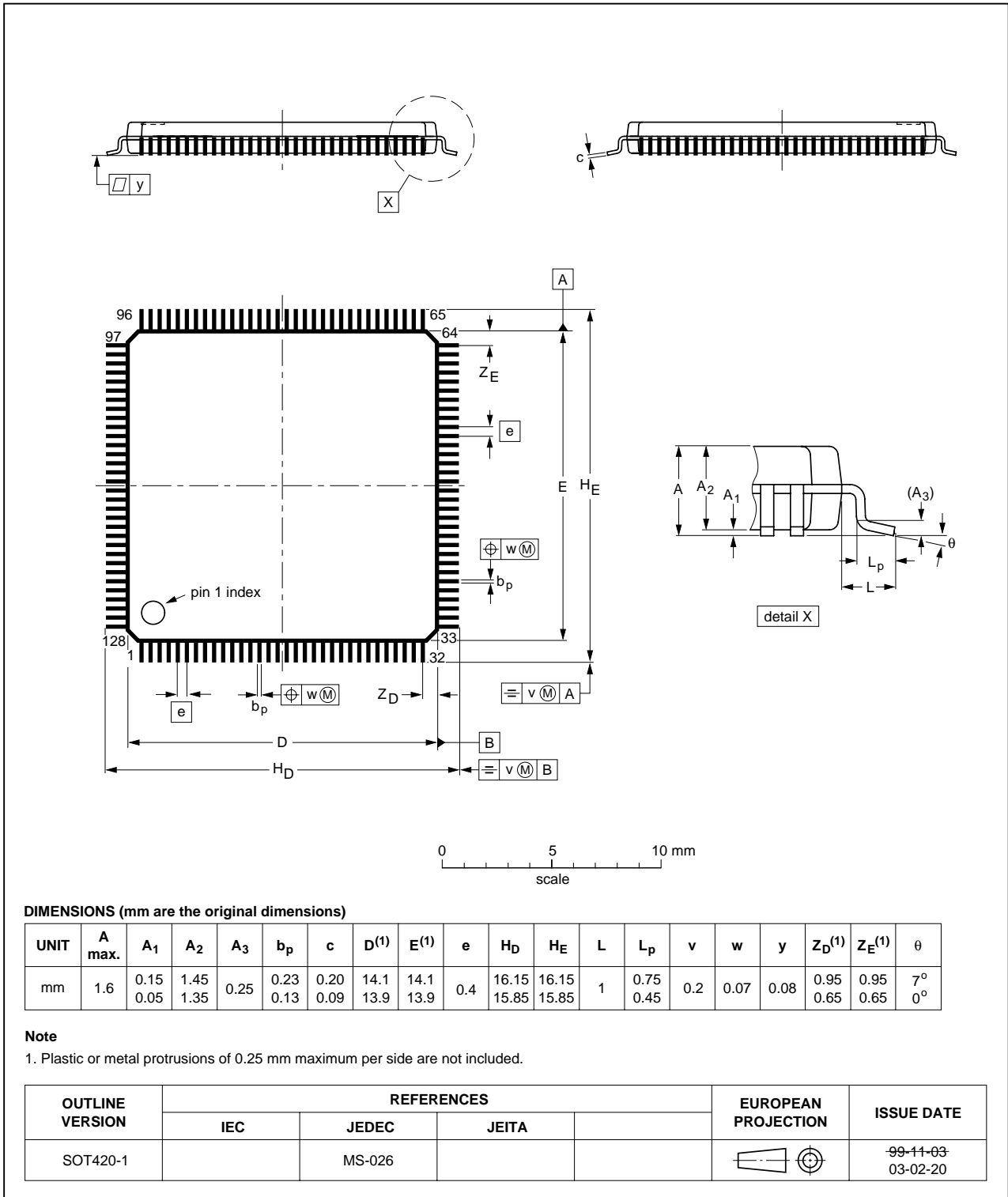

Fig 9. Package outline SOT420-1 (LQFP128)

18. Soldering

This text provides a very brief insight into a complex technology. A more in-depth account of soldering ICs can be found in Application Note *AN10365 "Surface mount reflow soldering description"*.

18.1 Introduction to soldering

Soldering is one of the most common methods through which packages are attached to Printed Circuit Boards (PCBs), to form electrical circuits. The soldered joint provides both the mechanical and the electrical connection. There is no single soldering method that is ideal for all IC packages. Wave soldering is often preferred when through-hole and Surface Mount Devices (SMDs) are mixed on one printed wiring board; however, it is not suitable for fine pitch SMDs. Reflow soldering is ideal for the small pitches and high densities that come with increased miniaturization.

18.2 Wave and reflow soldering

Wave soldering is a joining technology in which the joints are made by solder coming from a standing wave of liquid solder. The wave soldering process is suitable for the following:

- Through-hole components
- Leaded or leadless SMDs, which are glued to the surface of the printed circuit board

Not all SMDs can be wave soldered. Packages with solder balls, and some leadless packages which have solder lands underneath the body, cannot be wave soldered. Also, leaded SMDs with leads having a pitch smaller than ~0.6 mm cannot be wave soldered, due to an increased probability of bridging.

The reflow soldering process involves applying solder paste to a board, followed by component placement and exposure to a temperature profile. Leaded packages, packages with solder balls, and leadless packages are all reflow solderable.

Key characteristics in both wave and reflow soldering are:

- Board specifications, including the board finish, solder masks and vias
- Package footprints, including solder thieves and orientation
- The moisture sensitivity level of the packages
- Package placement
- Inspection and repair
- Lead-free soldering versus PbSn soldering

18.3 Wave soldering

Key characteristics in wave soldering are:

- Process issues, such as application of adhesive and flux, clinching of leads, board transport, the solder wave parameters, and the time during which components are exposed to the wave
- Solder bath specifications, including temperature and impurities

18.4 Reflow soldering

Key characteristics in reflow soldering are:

- Lead-free versus SnPb soldering; note that a lead-free reflow process usually leads to higher minimum peak temperatures (see [Figure 10](#)) than a PbSn process, thus reducing the process window
- Solder paste printing issues including smearing, release, and adjusting the process window for a mix of large and small components on one board
- Reflow temperature profile; this profile includes preheat, reflow (in which the board is heated to the peak temperature) and cooling down. It is imperative that the peak temperature is high enough for the solder to make reliable solder joints (a solder paste characteristic). In addition, the peak temperature must be low enough that the packages and/or boards are not damaged. The peak temperature of the package depends on package thickness and volume and is classified in accordance with [Table 136](#) and [137](#)

Table 136. SnPb eutectic process (from J-STD-020C)

Package thickness (mm)	Package reflow temperature (°C)	
	Volume (mm ³)	
	< 350	≥ 350
< 2.5	235	220
≥ 2.5	220	220

Table 137. Lead-free process (from J-STD-020C)

Package thickness (mm)	Package reflow temperature (°C)		
	Volume (mm ³)		
	< 350	350 to 2000	> 2000
< 1.6	260	260	260
1.6 to 2.5	260	250	245
> 2.5	250	245	245

Moisture sensitivity precautions, as indicated on the packing, must be respected at all times.

Studies have shown that small packages reach higher temperatures during reflow soldering, see [Figure 10](#).

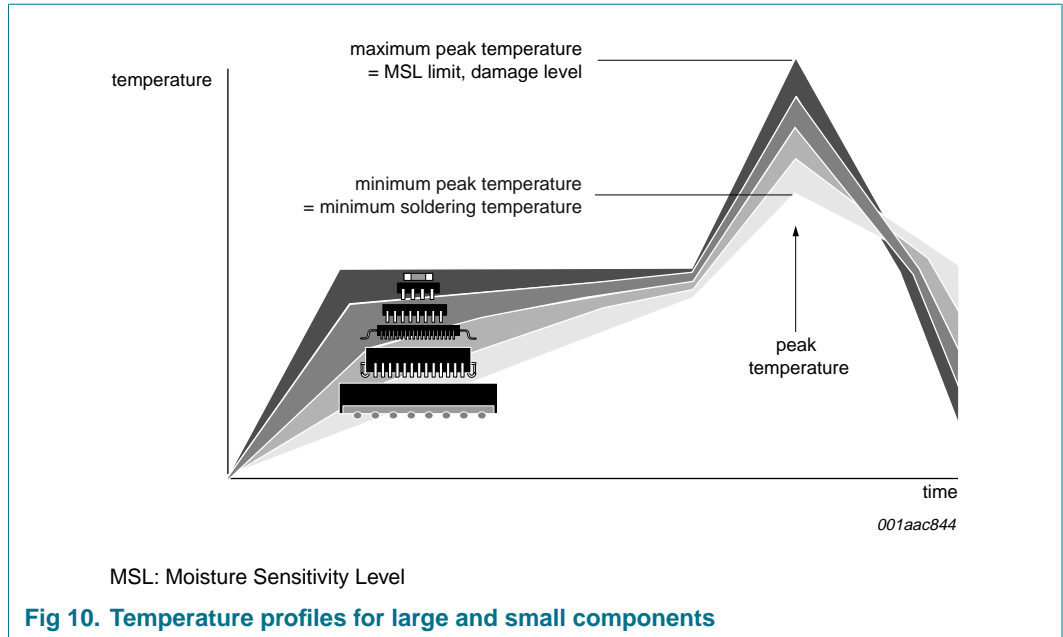

For further information on temperature profiles, refer to Application Note AN10365 “Surface mount reflow soldering description”.

19. Abbreviations

Table 138. Abbreviations

Acronym	Description
DID	Device ID
EHCI	Enhanced Host Controller Interface
EMI	ElectroMagnetic interference
EOF	End-Of-Frame
HC	Host Controller
HCCA	Host Controller Communication Area
HCD	Host Controller Driver
HCI	Host Controller Interface
OHCI	Open Host Controller Interface
PMC	Power Management Capabilities
PME	Power Management Event
PMCSR	Power Management Control/Status
USB	Universal Serial Bus
VID	Vendor ID

20. References

- [1] Designing a Hi-Speed USB Host PCI Adapter Using the ISP1561 — AN10006
- [2] Enhanced Host Controller Interface Specification for Universal Serial Bus — Rev. 095

- [3] **ISP1561 Evaluation Board User's Guide** — UM10005
- [4] **Open Host Controller Interface Specification for USB** — Rev. 1.0a
- [5] **PCI Bus Power Management Interface Specification** — Rev. 1.1
- [6] **PCI Local Bus Specification** — Rev. 2.2
- [7] **The I²C-bus Specification** — Version 2.1
- [8] **Universal Serial Bus Specification** — Rev. 2.0

21. Revision history

Table 139. Revision history

Document ID	Release date	Data sheet status	Change notice	Supersedes
ISP1561_2	20070305	Product data sheet	-	ISP1561-01
Modifications:	<ul style="list-style-type: none"> • The format of this data sheet has been redesigned to comply with the new identity guidelines of NXP Semiconductors. • Legal texts have been adapted to the new company name where appropriate. • Symbols and descriptions have been updated, wherever applicable, to comply with the new identity guidelines of NXP Semiconductors. • Updated Figure 1 “Block diagram”. • Table 2 “Pin description”: updated description for XTAL1, XTAL2, GLn, $\overline{PWE}n$, AMBn and GRNn. Updated I/O detail of pin SERR#. • Section 8.2.1.20 “TRDY Timeout register (R/W: 40h)” and Section 8.2.1.21 “Retry Timeout register (R/W: 41h)”: added description. • Table 23 “MIN_GNT register: bit description” and Table 24 “MAX_LAT register: but description”: updated the access type from R/W to R. • Section 11.4.8 “CONFIGFLAG register (address: content of the base address register + 4Ch)”: corrected the address in the title from 5Ch to 4Ch. • Table 119 “PORTSC 1, 2, 3, 4 register: bit description”: updated description for field LS[1:0]. • Section 12 “Current consumption”: updated. • Table 114 “ASYNCLISTADDR register: bit allocation” and Table 115 “ASYNCLISTADDR register: bit description”: changed LPL[19:0] to LPL[26:0]. • Table 124 “Recommended operating conditions”: added T_j. • Table 125 “Static characteristics: I²C-bus interface (SDA and SCL)” and Table 130 “Dynamic characteristics: I²C-bus interface (SDA and SCL)”: updated table title. • Table 129 “Dynamic characteristics: system clock timing”: updated. • Table 135 “PCI clock and IO timing”: updated t_h and added the max value for T_{cyc}. 			
ISP1561-01 (9397 750 10015)	20030206	Product data sheet	-	-

22. Legal information

22.1 Data sheet status

Document status ^{[1][2]}	Product status ^[3]	Definition
Objective [short] data sheet	Development	This document contains data from the objective specification for product development.
Preliminary [short] data sheet	Qualification	This document contains data from the preliminary specification.
Product [short] data sheet	Production	This document contains the product specification.

[1] Please consult the most recently issued document before initiating or completing a design.

[2] The term 'short data sheet' is explained in section "Definitions".

[3] The product status of device(s) described in this document may have changed since this document was published and may differ in case of multiple devices. The latest product status information is available on the Internet at URL <http://www.nxp.com>.

22.2 Definitions

Draft — The document is a draft version only. The content is still under internal review and subject to formal approval, which may result in modifications or additions. NXP Semiconductors does not give any representations or warranties as to the accuracy or completeness of information included herein and shall have no liability for the consequences of use of such information.

Short data sheet — A short data sheet is an extract from a full data sheet with the same product type number(s) and title. A short data sheet is intended for quick reference only and should not be relied upon to contain detailed and full information. For detailed and full information see the relevant full data sheet, which is available on request via the local NXP Semiconductors sales office. In case of any inconsistency or conflict with the short data sheet, the full data sheet shall prevail.

22.3 Disclaimers

General — Information in this document is believed to be accurate and reliable. However, NXP Semiconductors does not give any representations or warranties, expressed or implied, as to the accuracy or completeness of such information and shall have no liability for the consequences of use of such information.

Right to make changes — NXP Semiconductors reserves the right to make changes to information published in this document, including without limitation specifications and product descriptions, at any time and without notice. This document supersedes and replaces all information supplied prior to the publication hereof.

Suitability for use — NXP Semiconductors products are not designed, authorized or warranted to be suitable for use in medical, military, aircraft, space or life support equipment, nor in applications where failure or malfunction of a NXP Semiconductors product can reasonably be expected to

result in personal injury, death or severe property or environmental damage. NXP Semiconductors accepts no liability for inclusion and/or use of NXP Semiconductors products in such equipment or applications and therefore such inclusion and/or use is at the customer's own risk.

Applications — Applications that are described herein for any of these products are for illustrative purposes only. NXP Semiconductors makes no representation or warranty that such applications will be suitable for the specified use without further testing or modification.

Limiting values — Stress above one or more limiting values (as defined in the Absolute Maximum Ratings System of IEC 60134) may cause permanent damage to the device. Limiting values are stress ratings only and operation of the device at these or any other conditions above those given in the Characteristics sections of this document is not implied. Exposure to limiting values for extended periods may affect device reliability.

Terms and conditions of sale — NXP Semiconductors products are sold subject to the general terms and conditions of commercial sale, as published at <http://www.nxp.com/profile/terms>, including those pertaining to warranty, intellectual property rights infringement and limitation of liability, unless explicitly otherwise agreed to in writing by NXP Semiconductors. In case of any inconsistency or conflict between information in this document and such terms and conditions, the latter will prevail.

No offer to sell or license — Nothing in this document may be interpreted or construed as an offer to sell products that is open for acceptance or the grant, conveyance or implication of any license under any copyrights, patents or other industrial or intellectual property rights.

22.4 Trademarks

Notice: All referenced brands, product names, service names and trademarks are the property of their respective owners.

GoodLink — is a trademark of NXP B.V.

I²C-bus — logo is a trademark of NXP B.V.

23. Contact information

For additional information, please visit: <http://www.nxp.com>

For sales office addresses, send an email to: salesaddresses@nxp.com

24. Tables

Table 1.	Ordering information	3	Table 48.	HcCommandStatus register: bit description	39
Table 2.	Pin description	5	Table 49.	HcInterruptStatus register: bit allocation	40
Table 3.	PCI configuration space registers of OHCI1, OHCI2 and EHCI	13	Table 50.	HcInterruptStatus register: bit description	41
Table 4.	Vendor ID register: bit description	14	Table 51.	HcInterruptEnable register: bit allocation	42
Table 5.	Device ID register: bit description	14	Table 52.	HcInterruptEnable register: bit description	42
Table 6.	Command register: bit allocation	15	Table 53.	HcInterruptDisable register: bit allocation	43
Table 7.	Command register: bit description	15	Table 54.	HcInterruptDisable register: bit description	44
Table 8.	Status register: bit allocation	16	Table 55.	HcHCCA register: bit allocation	45
Table 9.	Status register: bit description	17	Table 56.	HcHCCA register: bit description	45
Table 10.	Revision ID register: bit description	18	Table 57.	HcPeriodCurrentED register: bit allocation	45
Table 11.	Class Code register: bit allocation	18	Table 58.	HcPeriodCurrentED register: bit description	46
Table 12.	Class Code register: bit description	18	Table 59.	HcControlHeadED register: bit allocation	46
Table 13.	CacheLine Size register: bit description	19	Table 60.	HcControlHeadED register: bit description	46
Table 14.	Latency Timer register: bit description	19	Table 61.	HcControlCurrentED register: bit allocation	47
Table 15.	Header Type register: bit allocation	19	Table 62.	HcControlCurrentED register: bit description	47
Table 16.	Header Type register: bit description	19	Table 63.	HcBulkHeadED register: bit allocation	47
Table 17.	BAR0 register: bit description	20	Table 64.	HcBulkHeadED register: bit description	48
Table 18.	Subsystem Vendor ID register: bit description	20	Table 65.	HcBulkCurrentED register: bit allocation	48
Table 19.	Subsystem ID register: bit description	21	Table 66.	HcBulkCurrentED register: bit description	49
Table 20.	Capabilities Pointer register: bit description	21	Table 67.	HcDoneHead register: bit allocation	49
Table 21.	Interrupt Line register: bit description	21	Table 68.	HcDoneHead register: bit description	49
Table 22.	Interrupt Pin register: bit description	22	Table 69.	HcFmInterval register: bit allocation	50
Table 23.	MIN_GNT register: bit description	22	Table 70.	HcFmInterval register: bit description	50
Table 24.	MAX_LAT register: but description	22	Table 71.	HcFmRemaining register: bit allocation	51
Table 25.	EHCI-specific PCI registers	23	Table 72.	HcFmRemaining register: bit description	51
Table 26.	SBRN register: bit description	23	Table 73.	HcFmNumber register: bit allocation	51
Table 27.	FLADJ register: bit allocation	23	Table 74.	HcFmNumber register: bit description	52
Table 28.	FLADJ register: bit description	23	Table 75.	HcPeriodicStart register: bit allocation	52
Table 29.	FLADJ value as a function of SOF cycle time	23	Table 76.	HcPeriodicStart register: bit description	53
Table 30.	PORTWAKECAP register: bit description	24	Table 77.	HcLSThreshold register: bit allocation	53
Table 31.	Power management registers	24	Table 78.	HcLSThreshold register: bit description	54
Table 32.	CAP_ID register: bit description	24	Table 79.	HcRhDescriptorA register: bit allocation	54
Table 33.	NEXT_ITEM_PTR register: bit description	25	Table 80.	HcRhDescriptorA register: bit description	55
Table 34.	PMC register: bit allocation	25	Table 81.	HcRhDescriptorB register: bit allocation	56
Table 35.	PMC register: bit description	25	Table 82.	HcRhDescriptorB register: bit description	56
Table 36.	PMCSR register: bit allocation	27	Table 83.	HcRhStatus register: bit allocation	57
Table 37.	PMCSR register: bit description	27	Table 84.	HcRhStatus register: bit description	57
Table 38.	PMCSR_BSE register: bit allocation	28	Table 85.	HcRhPortStatus[1:4] register: bit allocation	58
Table 39.	PMCSR_BSE register: bit description	28	Table 86.	HcRhPortStatus[1:4] register: bit description	59
Table 40.	PCI bus power and clock control	29	Table 87.	Legacy support registers	62
Table 41.	Data register: bit description	29	Table 88.	Emulated registers	62
Table 42.	USB Host Controller registers	33	Table 89.	HceControl register: bit allocation	62
Table 43.	HcRevision register: bit allocation	35	Table 90.	HceControl register: bit description	63
Table 44.	HcRevision register: bit description	36	Table 91.	HceInput register: bit allocation	63
Table 45.	HcControl register: bit allocation	36	Table 92.	HceInput register: bit description	64
Table 46.	HcControl register: bit description	37	Table 93.	HceOutput register: bit allocation	64
Table 47.	HcCommandStatus register: bit allocation	39	Table 94.	HceOutput register: bit description	65
			Table 95.	HceStatus register: bit allocation	65

continued >>

Table 96. HceStatus register: bit description	65	Table 137. Lead-free process (from J-STD-020C)	94
Table 97. CAPLENGTH/HCIVERSION register: bit allocation	66	Table 138. Abbreviations	95
Table 98. CAPLENGTH/HCIVERSION register: bit description	67	Table 139. Revision history	97
Table 99. HCSPARAMS register: bit allocation	67		
Table 100. HCSPARAMS register: bit description	67		
Table 101. HCCPARAMS register: bit allocation	68		
Table 102. HCCPARAMS register: bit description	69		
Table 103. USBCMD register: bit allocation	69		
Table 104. USBCMD register: bit description	70		
Table 105. USBSTS register: bit allocation	72		
Table 106. USBSTS register: bit description	72		
Table 107. USBINTR register: bit allocation	74		
Table 108. USBINTR register: bit description	74		
Table 109. FRINDEX register: bit allocation	75		
Table 110. FRINDEX register: bit description	76		
Table 111. N based value of FLS[1:0]	76		
Table 112. PERIODICLISTBASE register: bit allocation	77		
Table 113. PERIODICLISTBASE register: bit description	77		
Table 114. ASYNCLISTADDR register: bit allocation	77		
Table 115. ASYNCLISTADDR register: bit description	78		
Table 116. CONFIGFLAG register: bit allocation	78		
Table 117. CONFIGFLAG register: bit description	78		
Table 118. PORTSC 1, 2, 3, 4 register: bit allocation	79		
Table 119. PORTSC 1, 2, 3, 4 register: bit description	79		
Table 120. Current consumption when SEL2PORTS is HIGH	83		
Table 121. Current consumption when SEL2PORTS is LOW	83		
Table 122. Current consumption: S1 and S3	84		
Table 123. Limiting values	85		
Table 124. Recommended operating conditions	85		
Table 125. Static characteristics: I ² C-bus interface (SDA and SCL)	86		
Table 126. Static characteristics: digital pins	86		
Table 127. Static characteristics: PCI interface block	86		
Table 128. Static characteristics: USB interface block (pins DM1 to DM4 and DP1 to DP4)	86		
Table 129. Dynamic characteristics: system clock timing	88		
Table 130. Dynamic characteristics: I ² C-bus interface (SDA and SCL)	88		
Table 131. Dynamic characteristics: PCI interface block	88		
Table 132. Dynamic characteristics: high-speed source electrical characteristics	88		
Table 133. Dynamic characteristics: full-speed source electrical characteristics	89		
Table 134. Dynamic characteristics: low-speed source electrical characteristics	89		
Table 135. PCI clock and IO timing	90		
Table 136. SnPb eutectic process (from J-STD-020C)	94		

continued >>

25. Figures

Fig 1.	Block diagram	.4
Fig 2.	Pin configuration	.5
Fig 3.	EEPROM connection diagram	.30
Fig 4.	Information loading from EEPROM	.31
Fig 5.	PCI clock	.90
Fig 6.	PCI input timing	.91
Fig 7.	PCI output timing	.91
Fig 8.	USB source differential data-to-EOP transition skew and EOP width	.91
Fig 9.	Package outline SOT420-1 (LQFP128)	.92
Fig 10.	Temperature profiles for large and small components	.95

[continued >>](#)

26. Contents

1	General description	1	8.2.2	Enhanced Host Controller-specific PCI registers	23
2	Features	2	8.2.2.1	SBRN register (address: 60h)	23
3	Applications	2	8.2.2.2	FLADJ register (address: 61h)	23
4	Ordering information	3	8.2.2.3	PORTWAKECAP register (address: 62h)	24
5	Block diagram	4	8.2.3	Power management registers.	24
6	Pinning information	5	8.2.3.1	CAP_ID register (address: value read from address 34h + 0h)	24
6.1	Pinning	5	8.2.3.2	NEXT_ITEM_PTR register (address: value read from address 34h + 1h)	25
6.2	Pin description	5	8.2.3.3	PMC register (address: value read from address 34h + 2h)	25
7	Functional description	11	8.2.3.4	PMCSR register (address: value read from address 34h + 4h)	26
7.1	OHCI Host Controller	11	8.2.3.5	PMCSR_BSE register (address: value read from address 34h + 6h)	28
7.2	EHCI Host Controller	11	8.2.3.6	Data register (address: value read from address 34h + 7h)	29
7.3	Dynamic port-routing logic	11	9	I²C-bus interface	30
7.4	Hi-Speed USB analog transceivers	11	9.1	Protocol	30
7.5	LED indicators for downstream ports	11	9.2	Hardware connections	30
7.6	Power management	12	9.3	Information loading from EEPROM	31
7.7	Legacy support.	12	10	Power management.	31
7.8	Phase-Locked Loop (PLL)	12	10.1	PCI bus power states	31
8	PCI	12	10.2	USB bus states	32
8.1	PCI interface	12	11	USB Host Controller registers	32
8.1.1	PCI configuration space	12	11.1	OHCI USB Host Controller operational registers	35
8.1.2	PCI initiator and target	13	11.1.1	HcRevision register (address: content of the base address register + 00h)	35
8.2	PCI configuration registers	13	11.1.2	HcControl register (address: content of the base address register + 04h)	36
8.2.1	PCI configuration header registers	14	11.1.3	HcCommandStatus register (address: content of the base address register + 08h)	38
8.2.1.1	Vendor ID register (address: 00h)	14	11.1.4	HcInterruptStatus register (address: content of the base address register + 0Ch)	40
8.2.1.2	Device ID register (address: 02h)	14	11.1.5	HcInterruptEnable register (address: content of the base address register + 10h)	41
8.2.1.3	Command register (address: 04h)	15	11.1.6	HcInterruptDisable register (address: content of the base address register + 14h)	43
8.2.1.4	Status register (address: 06h)	16	11.1.7	HcHCCA register (address: content of the base address register + 18h)	44
8.2.1.5	Revision ID register (address: 08h)	18	11.1.8	HcPeriodCurrentED register (address: content of the base address register + 1Ch)	45
8.2.1.6	Class Code register (address: 09h)	18	11.1.9	HcControlHeadED register (address: content of the base address register + 20h)	46
8.2.1.7	CacheLine Size register (address: 0Ch)	19			
8.2.1.8	Latency Timer register (address: 0Dh)	19			
8.2.1.9	Header Type register (address: 0Eh)	19			
8.2.1.10	BIST register (address: 0Fh)	20			
8.2.1.11	Base Address registers.	20			
8.2.1.12	CardBus CIS Pointer register (address: 28h)	20			
8.2.1.13	Subsystem Vendor ID register (address: 2Ch)	20			
8.2.1.14	Subsystem ID register (address: 2Eh)	21			
8.2.1.15	Expansion ROM Base Address register (address: 30h)	21			
8.2.1.16	Capabilities Pointer register (address: 34h)	21			
8.2.1.17	Interrupt Line register (address: 3Ch)	21			
8.2.1.18	Interrupt Pin register (address: 3Dh)	22			
8.2.1.19	MIN_GNT and MAX_LAT registers (address: 3Eh and 3Fh)	22			
8.2.1.20	TRDY Timeout register (R/W: 40h)	22			
8.2.1.21	Retry Timeout register (R/W: 41h)	22			

continued >>

11.1.10	HcControlCurrentED register (address: content of the base address register + 24h)	47	11.4.4	FRINDEX register (address: content of the base address register + 18h)	75
11.1.11	HcBulkHeadED register (address: content of the base address register + 28h)	47	11.4.5	CTRLDSSEGMENT register (address: content of the base address register + 1Ch)	76
11.1.12	HcBulkCurrentED register (address: content of the base address register + 2Ch)	48	11.4.6	PERIODICLISTBASE register (address: content of the base address register + 20h)	76
11.1.13	HcDoneHead register (address: content of the base address register + 30h)	49	11.4.7	ASYNCLISTADDR register (address: content of the base address register + 24h)	77
11.1.14	HcFmInterval register (address: content of the base address register + 34h)	50	11.4.8	CONFIGFLAG register (address: content of the base address register + 4Ch)	78
11.1.15	HcFmRemaining register (address: content of the base address register + 38h)	51	11.4.9	PORTSC registers 1, 2, 3, 4 (address: content of the base address register + 50h + (4 times Port Number - 1)) where Port Number is 1, 2, 3, ..., N_Ports	79
11.1.16	HcFmNumber register (address: content of the base address register + 3Ch)	51	12	Current consumption	83
11.1.17	HcPeriodicStart register (address: content of the base address register + 40h)	52	13	Limiting values	85
11.1.18	HcLSThreshold register (address: content of the base address register + 44h)	53	14	Recommended operating conditions	85
11.1.19	HcRhDescriptorA register (address: content of the base address register + 48h)	54	15	Static characteristics	86
11.1.20	HcRhDescriptorB register (address: content of the base address register + 4Ch)	55	16	Dynamic characteristics	88
11.1.21	HcRhStatus register (address: content of the base address register + 50h)	56	16.1	Timing	90
11.1.22	HcRhPortStatus[1:4] register (address: content of the base address register + 54h)	58	17	Package outline	92
11.2	USB legacy support registers	61	18	Soldering	93
11.2.1	HceControl register (address: content of the base address register + 100h)	62	18.1	Introduction to soldering	93
11.2.2	HceInput register (address: content of the base address register + 104h)	63	18.2	Wave and reflow soldering	93
11.2.3	HceOutput register (address: content of the base address register + 108h)	64	18.3	Wave soldering	93
11.2.4	HceStatus register (address: content of the base address register + 10Ch)	65	18.4	Reflow soldering	94
11.3	EHCI controller capability registers	66	19	Abbreviations	95
11.3.1	CAPLENGTH/HCIVERSION register (address: content of the base address register + 00h)	66	20	References	95
11.3.2	HCSPARAMS register (address: content of the base address register + 04h)	67	21	Revision history	97
11.3.3	HCCPARAMS register (address: content of the base address register + 08h)	68	22	Legal information	98
11.4	Operational registers of enhanced USB Host Controller	69	22.1	Data sheet status	98
11.4.1	USBCMD register (address: content of the base address register + 0Ch)	69	22.2	Definitions	98
11.4.2	USBSTS register (address: content of the base address register + 10h)	72	22.3	Disclaimers	98
11.4.3	USBINTR register (address: content of the base address register + 14h)	74	22.4	Trademarks	98
			23	Contact information	98
			24	Tables	99
			25	Figures	101
			26	Contents	102

Please be aware that important notices concerning this document and the product(s) described herein, have been included in section 'Legal information'.



© NXP B.V. 2007.



All rights reserved.

For more information, please visit: <http://www.nxp.com>
 For sales office addresses, please send an email to: salesaddresses@nxp.com





Date of release: 5 March 2007
 Document identifier: ISP1561_2

Looking for pricing, stock, or lifecycle information?

Click below to explore more details on WIN SOURCE:

-  [View ISP1561BMUM on WIN SOURCE](#)
-  [ST-Ericsson Inc Information](#)

Optimize Your Supply Chain with WIN SOURCE Solutions

-  Global Sourcing Solution
-  Obsolete Management
-  Cost Control Management
-  Shortage Management
-  Alternative Solution
-  Excess Inventory Management