



**THE DATASHEET OF
IXFR36N50P**



PolarHV™ HiPerFET IXFC 36N50P Power MOSFET IXFR 36N50P (Electrically Isolated Back Surface)

$V_{DSS} = 500 \text{ V}$
 $I_{D25} = 19 \text{ A}$
 $R_{DS(on)} \leq 190 \text{ m}\Omega$
 $t_{rr} \leq 200 \text{ ns}$

N-Channel Enhancement Mode
Avalanche Rated
Fast Intrinsic Diode

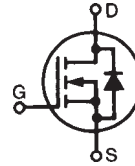

Symbol	Test Conditions	Maximum Ratings	
V_{DSS}	$T_J = 25^\circ\text{C}$ to 150°C	500	V
V_{DGR}	$T_J = 25^\circ\text{C}$ to 150°C ; $R_{GS} = 1 \text{ M}\Omega$	500	V
V_{GSS}	Continuous	± 30	V
V_{GSM}	Transient	± 40	V
I_{D25}	$T_C = 25^\circ\text{C}$	19	A
I_{DM}	$T_C = 25^\circ\text{C}$, pulse width limited by T_{JM}	100	A
I_{AR}	$T_C = 25^\circ\text{C}$	36	A
E_{AR}	$T_C = 25^\circ\text{C}$	50	mJ
E_{AS}	$T_C = 25^\circ\text{C}$	1.5	J
dv/dt	$I_S \leq I_{DM}$, $di/dt \leq 100 \text{ A}/\mu\text{s}$, $V_{DD} \leq V_{DSS}$, $T_J \leq 150^\circ\text{C}$, $R_G = 4 \Omega$	20	V/ns
P_D	$T_C = 25^\circ\text{C}$	156	W
T_J		-55 ... +150	$^\circ\text{C}$
T_{JM}		150	$^\circ\text{C}$
T_{stg}		-55 ... +150	$^\circ\text{C}$
T_L	1.6 mm (0.062 in.) from case for 10 s	300	$^\circ\text{C}$
V_{ISOL}	50/60 Hz, RMS, 1 minute	2500	V~
F_C	Mounting Force	(IXFC) 11..65 / 2.5..15 (IXFR) 20..120 / 4.5..25	N/lb N/lb
Weight	(IXFC) (IXFR)	3 5	g g

ISOPLUS220™ (IXFC)
E153432

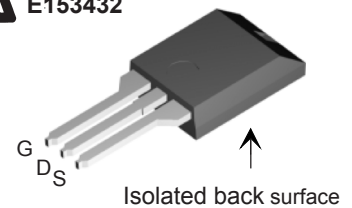

ISOPLUS247™ (IXFR)
E153432

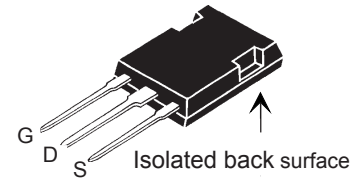

G = Gate D = Drain
S = Source

Features

- † International standard isolated packages
- † UL recognized packages
- † Silicon chip on Direct-Copper-Bond substrate
 - High power dissipation
 - Isolated mounting surface
 - 2500V electrical isolation
- † Unclamped Inductive Switching (UIS) rated
- † Low package inductance
- easy to drive and to protect
- † Fast intrinsic diode

Advantages

- † Easy to mount
- † Space savings
- † High power density

Symbol	Test Conditions ($T_J = 25^\circ\text{C}$ unless otherwise specified)	Characteristic Values		
		Min.	Typ.	Max.
BV_{DSS}	$V_{GS} = 0 \text{ V}$, $I_D = 250 \mu\text{A}$	500		V
$V_{GS(th)}$	$V_{DS} = V_{GS}$, $I_D = 4 \text{ mA}$	2.5		5.0 V
I_{GSS}	$V_{GS} = \pm 30 \text{ V}_{DC}$, $V_{DS} = 0$			$\pm 100 \text{ nA}$
I_{DSS}	$V_{DS} = V_{DSS}$ $V_{GS} = 0 \text{ V}$ $T_J = 125^\circ\text{C}$			25 μA 250 μA
$R_{DS(on)}$	$V_{GS} = 10 \text{ V}$, $I_D = I_T$			190 $\text{m}\Omega$

Symbol	Test Conditions	Characteristic Values ($T_J = 25^\circ\text{C}$ unless otherwise specified)			
		Min.	Typ.	Max.	
g_{fs}	$V_{DS} = 20\text{ V}; I_D = I_T$, Note 1	23	35		S
C_{iss}	$V_{GS} = 0\text{ V}, V_{DS} = 25\text{ V}, f = 1\text{ MHz}$		5500		pF
C_{oss}			510		pF
C_{rss}			40		pF
$t_{d(on)}$	$V_{GS} = 10\text{ V}, V_{DS} = 0.5 I_{D25}$ $R_G = 4\ \Omega$ (External)		29		ns
t_r			23		ns
$t_{d(off)}$			82		ns
t_f			23		ns
$Q_{g(on)}$	$V_{GS} = 10\text{ V}, V_{DS} = 0.5 V_{DSS}, I_D = I_T$		93		nC
Q_{gs}			30		nC
Q_{gd}			31		nC
R_{thJC}				0.75	$^\circ\text{C/W}$
R_{thCS}	(ISOPLUS 247)	0.15			$^\circ\text{C/W}$
	(ISOPLUS 220)	0.21			$^\circ\text{C/W}$

Symbol	Test Conditions	Characteristic Values ($T_J = 25^\circ\text{C}$, unless otherwise specified)			
		Min.	Typ.	Max.	
I_s	$V_{GS} = 0\text{ V}$			36	A
I_{SM}	Repetitive			100	A
V_{SD}	$I_F = I_s, V_{GS} = 0\text{ V}$			1.5	V
t_{rr}	$I_F = 25\text{ A}, -di/dt = 100\text{ A}/\mu\text{s}$ $V_R = 100\text{ V}; V_{GS} = 0\text{ V}$			200	ns
I_{RM}				8	A
Q_{RM}			0.6		μC

- Notes:
1. Pulse test, $t \leq 300\ \mu\text{s}$, duty cycle $d \leq 2\%$;
 2. Test current $I_T = 18\text{ A}$.

ISOPLUS220™ (IXFC) Outline

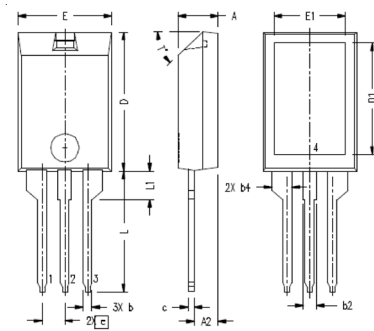

Note:
Bottom heatsink (Pin 4) is electrically isolated from Pin 1, 2, or 3.

SYM	INCHES		MILLIMETERS	
	MIN	MAX	MIN	MAX
A	.157	.197	4.00	5.00
A2	.098	.118	2.50	3.00
b	.035	.051	0.90	1.30
b2	.049	.065	1.25	1.65
b4	.093	.100	2.35	2.55
c	.028	.039	0.70	1.00
D	.591	.630	15.00	16.00
D1	.472	.512	12.00	13.00
E	.394	.433	10.00	11.00
E1	.295	.335	7.50	8.50
e	.100 BASIC		2.55 BASIC	
L	.512	.571	13.00	14.50
L1	.118	.138	3.00	3.50
T*			42.5*	47.5*

Ref. IXYS CO 0177 R0

ISOPLUS247 Outline

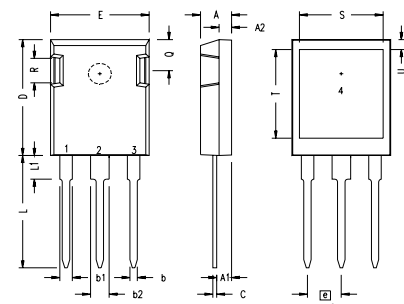

SYM	INCHES		MILLIMETERS	
	MIN	MAX	MIN	MAX
A	.190	.205	4.83	5.21
A1	.090	.100	2.29	2.54
A2	.075	.085	1.91	2.16
b	.045	.055	1.14	1.40
b1	.075	.084	1.91	2.13
b2	.115	.123	2.92	3.12
C	.024	.031	0.61	0.80
D	.819	.840	20.80	21.34
E	.620	.635	15.75	16.13
e	.215 BSC		5.45 BSC	
L	.780	.800	19.81	20.32
L1	.150	.170	3.81	4.32
Q	.220	.244	5.59	6.20
R	.170	.190	4.32	4.83
S	.520	.540	13.21	13.72
T	.620	.640	15.75	16.26
U	.065	.080	1.65	2.03

- 1 - GATE
- 2 - DRAIN (COLLECTOR)
- 3 - SOURCE (EMITTER)
- 4 - NO CONNECTION

NOTE: This drawing will meet all dimensions requirement of JEDEC outline TO-247AD except screw hole.

IXYS reserves the right to change limits, test conditions, and dimensions.

IXYS MOSFETs and IGBTs are covered by	4,835,592	4,931,844	5,049,961	5,237,481	6,162,665	6,404,065 B1	6,683,344	6,727,585
one or more of the following U.S. patents:	4,850,072	5,017,508	5,063,307	5,381,025	6,259,123 B1	6,534,343	6,710,405B2	6,759,692
	4,881,106	5,034,796	5,187,117	5,486,715	6,306,728 B1	6,583,505	6,710,463	6,771,478 B2

Fig. 1. Output Characteristics
@ 25°C

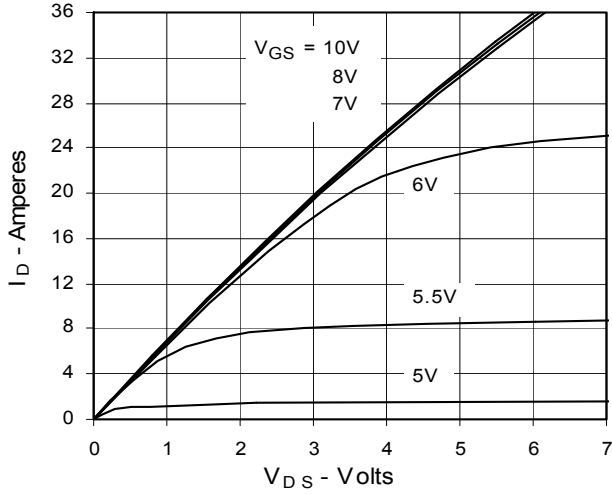

Fig. 2. Extended Output Characteristics
@ 25°C

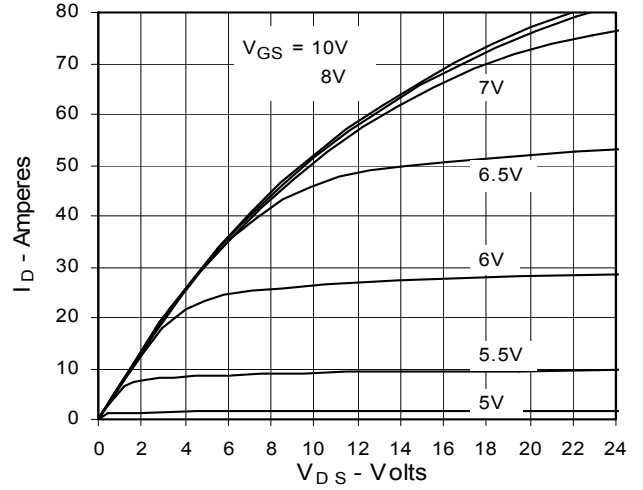

Fig. 3. Output Characteristics
@ 125°C

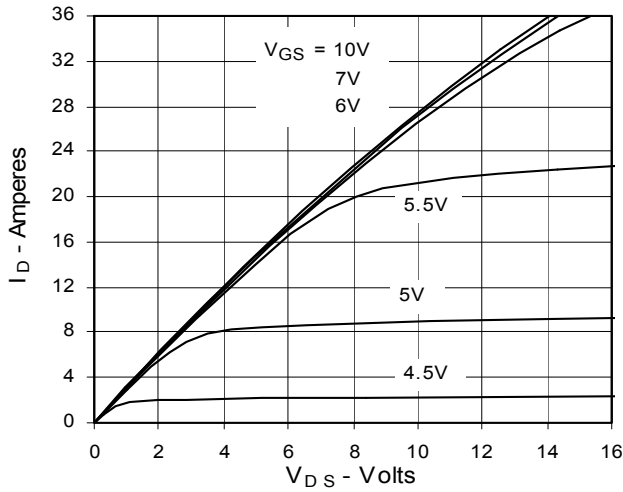

Fig. 4. $R_{DS(on)}$ Normalized to $I_D = 18\text{A}$
Value vs. Junction Temperature

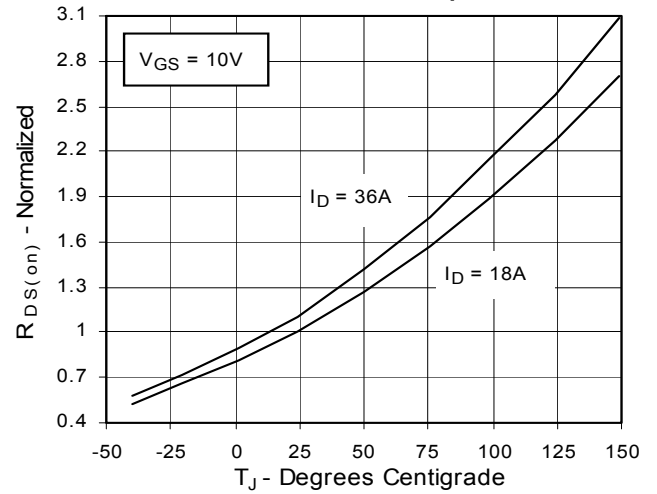

Fig. 5. $R_{DS(on)}$ Normalized to
 $I_D = 18\text{A}$ Value vs. Drain Current

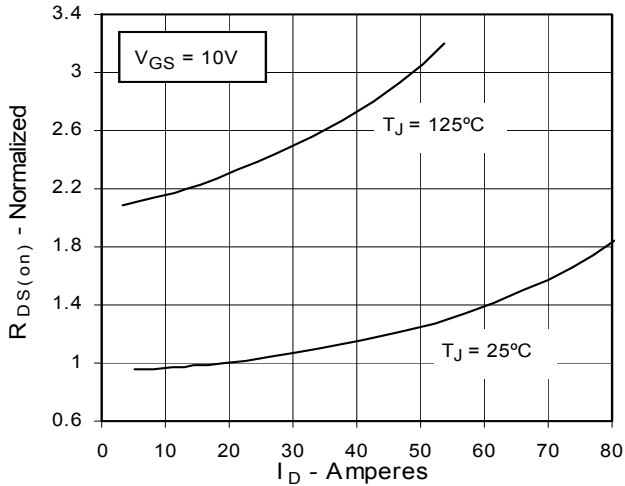

Fig. 6. Drain Current vs. Case
Temperature

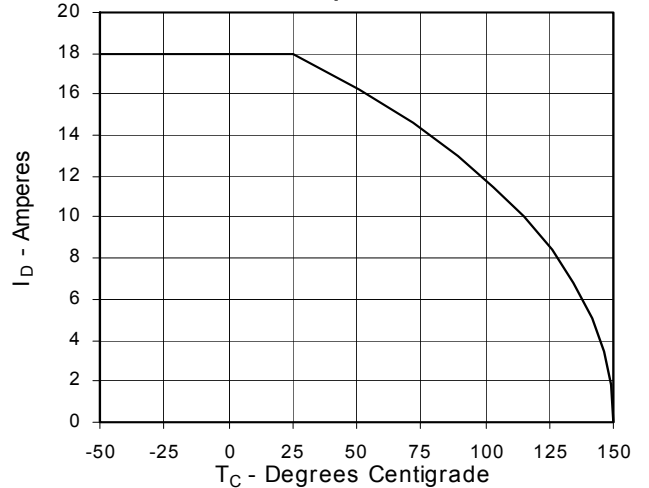

Fig. 7. Input Admittance

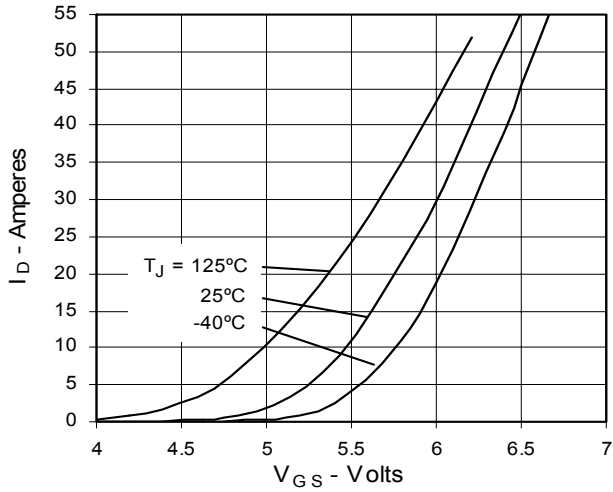

Fig. 8. Transconductance

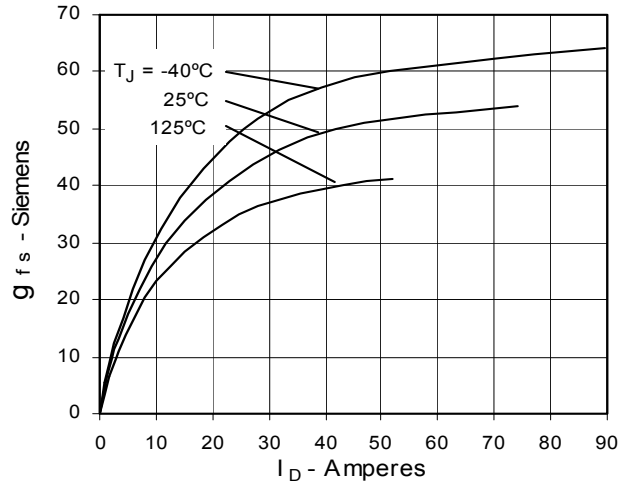

Fig. 9. Source Current vs. Source-To-Drain Voltage

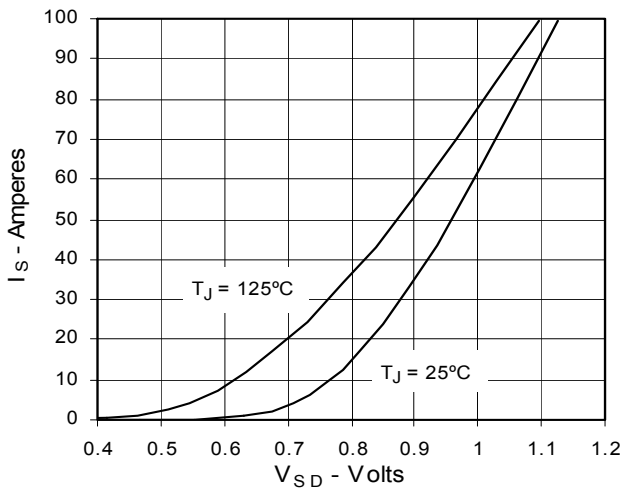

Fig. 10. Gate Charge

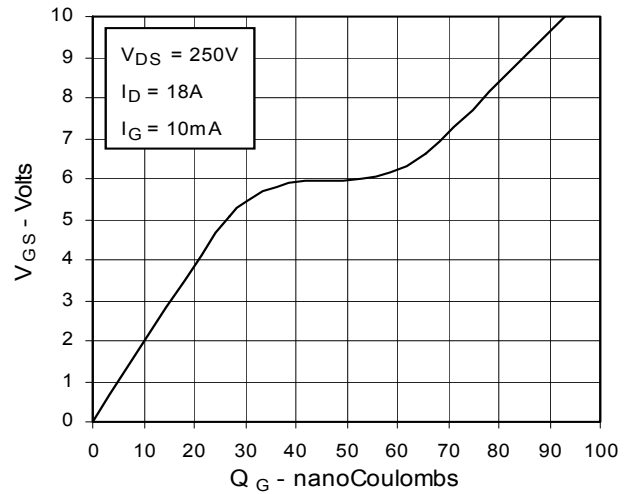

Fig. 11. Capacitance

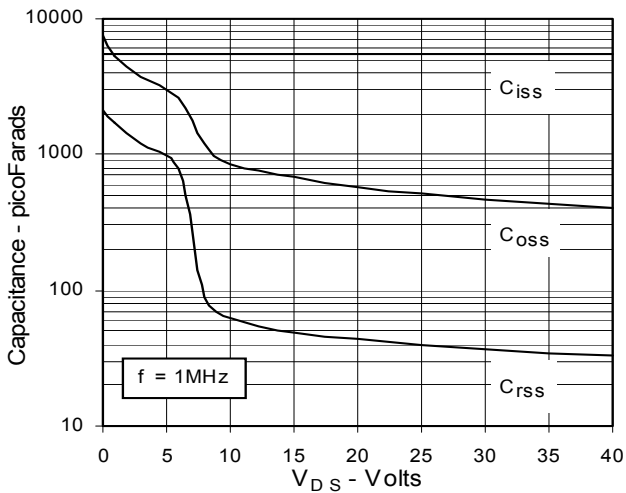

Fig. 12. Forward-Bias Safe Operating Area

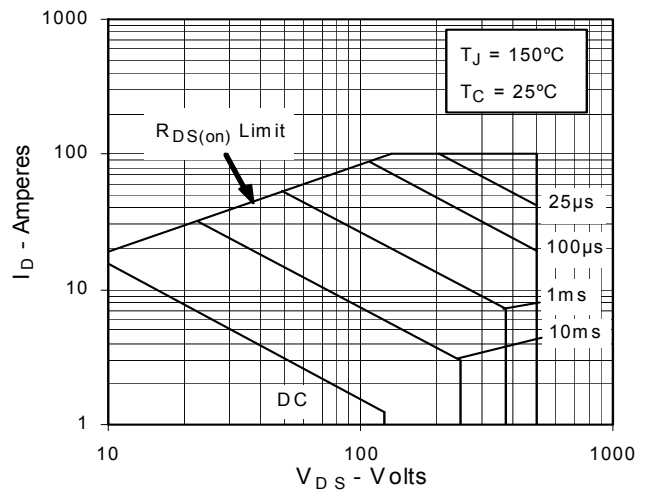
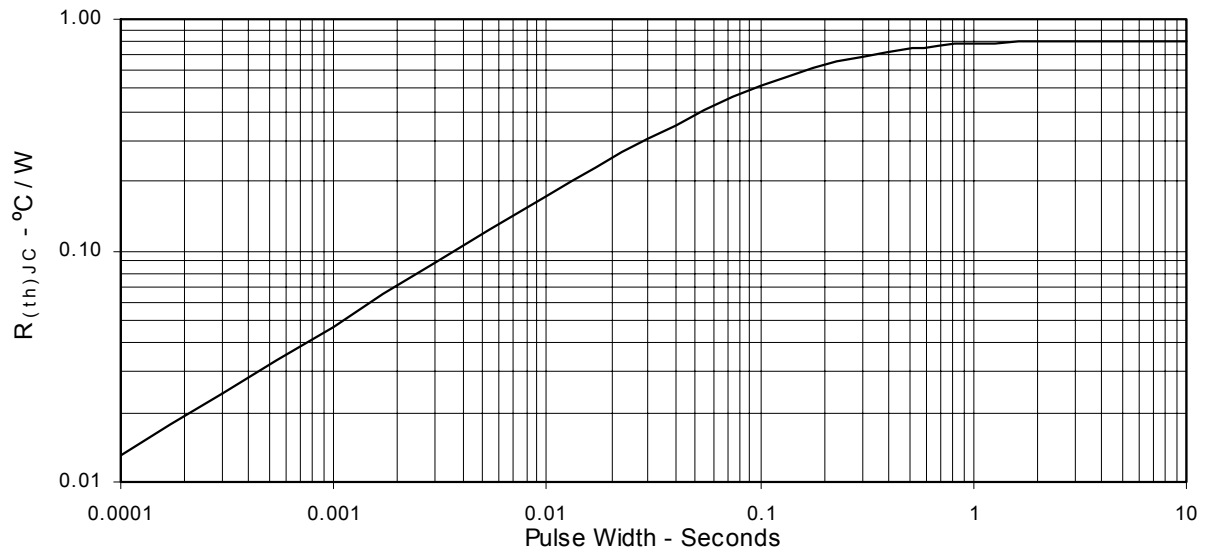

Fig. 13. Maximum Transient Thermal Resistance





Disclaimer Notice - Information furnished is believed to be accurate and reliable. However, users should independently evaluate the suitability of and test each product selected for their own applications. Littelfuse products are not designed for, and may not be used in, all applications. Read complete Disclaimer Notice at www.littelfuse.com/disclaimer-electronics.

Looking for pricing, stock, or lifecycle information?

Click below to explore more details on WIN SOURCE:

 [View IXFR36N50P on WIN SOURCE](#)

 [IXYS Information](#)

Optimize Your Supply Chain with WIN SOURCE Solutions

-  Global Sourcing Solution
-  Obsolete Management
-  Cost Control Management
-  Shortage Management
-  Alternative Solution
-  Excess Inventory Management