

PRODUCT GUIDE

MOSFETs



Toshiba's MOSFET devices meet the needs of a wide range of ultra-high-density applications.

POWER-MOSFETS CONTENTS

1 Features and Structures	3
2 Toshiba's MOSFET Product Lines and Part Numbering Schemes	4
2-1 MOSFET Product Lines	4
2-2 Part Numbering Schemes	5
3 Selection Guide (By Absolute Maximum Ratings)	6
4 Low-V_{DSS} MOSFETs (in Small SMD Packages)	16
4-1 Packaging Options	16
• SSM Series	
• TPC Series	
4-2 Application Examples and Block Diagrams	17
• Cell Phone (Power Supply Circuit)	
• Notebook PC (Power Supply Circuit)	
• Lithium-Ion Secondary Battery (Battery Protection Circuits)	
• Motor Driver (Power Driver Circuit)	
4-3 Low-V _{DSS} MOSFET Roadmaps	19
• Roadmap for Trench MOSFETs	
• Package Options	
4-4 Low-V _{DSS} , High-Speed MOSFETs	21
• Synchronous Rectification DC-DC Converters	
– Block Diagram, Timing Chart and Power Loss Factors	
– Summary Results of Power Loss Simulation and Key Parameters for MOSFETs	
– Efficiency Improvement by Thermally Enhanced Package and New Process Technology	
– MOSBD (MOSFET with SBD)	
• High-Speed MOSFET Offerings	
4-5 Low-V _{DSS} , Low-R _{DS(ON)} MOSFETs (for Lithium-Ion Battery Protection)	26
• Lithium-Ion Battery Protection Circuit Trend	
• MOSFET Roadmap	
• Low-ON-resistance N-Channel Power MOSFETs	
• Low-ON-resistance P-Channel Power MOSFETs	
4-6 Semi-Power MOSFET Offerings	28
• Semi-Power P-Channel Single MOSFETs	
• Semi-Power N-Channel Single MOSFETs	
• Semi-Power Dual MOSFETs	
• MOSFET with a Schottky Barrier Diode	
• VS-6 Series ... [Part Number: TPC6xxx]	
• VS-8 Series ... [Part Number: TPCF8xxx]	
• PS-8 Series ... [Part Number: TPCP8xxx]	
• Chip LGA Series ... [Part Number: TPCL4xxx]	
• STP2 Series ... [Part Number: TPCT4xxx]	
• TSON Advance Series ... [Part Number: TPCC8xxx]	
• TSSOP Advance Series ... [Part Number: TPCM8xxx]	
• SOP-8 Series ... [Part Number: TPC8xxx]	
• SOP Advance Series ... [Part Number: TPCA8xxx]	
• DPAK Series ... [Part Number: TKxxPxxM1]	
4-7 Standard MOSFET Series (I _D < 500 mA)	36
• Single MOSFETs	
• Dual MOSFETs	
5 Low-V_{DSS}, High-Q_g MOSFETs	37
5-1 TO-220SM(W) Series	37
5-2 U-MOS (Trench Type) Series	38
5-3 U-MOS Series for Synchronous Rectification (V _{DSS} = 60 V to 150 V)	39
6 Mid- and High-V_{DSS} MOSFETs	40
6-1 π -MOSVII Series (V _{DSS} = 450 V to 650 V)	40
6-2 Super-Junction DTMOS Series (V _{DSS} = 600 V, 650 V)	41
6-3 High-speed π -MOS Series (V _{DSS} = 450 V to 600 V)	42
6-4 π -MOS Series	43
7 MOSFET Part Numbers	46
7-1 Alphanumeric Index of Part Numbers	46
8 Product Obsolescence	53
8-1 End-of-Life Products	53
9 Packaging	55
9-1 Compact Surface-Mount Packages	55
9-2 Through-Hole Packages	66

- 1) No carrier storage effect; superior frequency and switching characteristics
- 2) Rugged and no current concentration
- 3) Voltage-controlled device, hence low drive power
- 4) Easy parallel connection

■ Toshiba MOSFETs have the following additional features:

- 1) Guaranteed avalanche capability..... Allows an absorber circuit to be simplified
- 2) Improved functioning of built-in diodes Enhanced circuit design flexibility
- 3) High ruggedness Increased margin for circuit design
- 4) High-speed switching Higher speed in end-product's operation
- 5) Low $R_{(DS)ON}$ Reduced end-product's power consumption
- 6) Smaller packages Reduced end-product size
- 7) Low drive loss Reduced end product's power

■ Structures of Toshiba MOSFETs

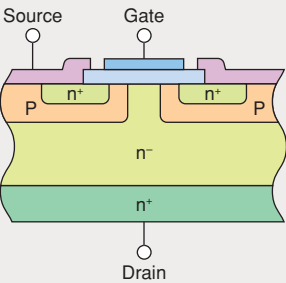
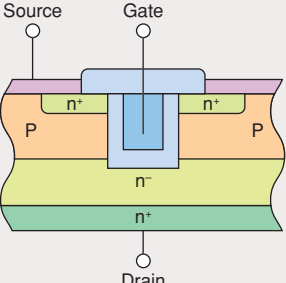
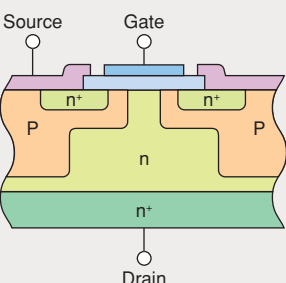
<p>Double-Diffusion Structure</p> 	<p>● π-MOS</p> <p>Toshiba Power MOSFETs use a double-diffusion MOS (D-MOS) structure, which produces high-withstand voltage, to form channels. This structure is especially well suited to high-withstand voltage and high-current devices. A high level of integration yields a high-performance Power MOSFET with low ON-resistance and low power loss.</p>
<p>Trench Structure</p> 	<p>● U-MOS</p> <p>Higher channel density is achieved by connecting channels vertically to form a U-groove at the gate region, a structure that yields a lower ON-resistance than other MOSFET structures.</p>
<p>Super-Junction Structure</p> 	<p>● DTMOS</p> <p>The super-junction structure, which has P-type pillar layers as shown left, realizes high withstand voltage and ON-resistance lower than the conventional theoretical limit of silicon.</p>

2-1 MOSFET Product Lines

SSM Series ($V_{DSS} = 12\text{ V to }60\text{ V}$)

Very compact and thin, the SSM Series is suitable for use in various electronic devices. The SSM Series is available in a wide range of packages and features low voltage drive.

- Applications
- Cell phones ● Notebook PCs
- Portable electronic devices ● Small-signal switching

VS and PS Series ($V_{DSS} = 12\text{ V to }40\text{ V}$)

Very compact and thin, the VS and PS Series are suitable for use in various electronic devices.

- Applications
- Cell phones ● Notebook PCs
- Portable electronic devices

Chip LGA and STP Series ($V_{DSS} = 20\text{ V to }30\text{ V}$)

The LGA and STP Series are housed in an ultra-small and thin package and are suitable for use in lithium-ion secondary battery protection circuits in various portable electronic devices.

- Applications
- Lithium-ion secondary battery protection circuits

SOP and TSON Series ($V_{DSS} = 20\text{ V to }250\text{ V}$)

The SOP and TSON Series are compact and thin, and require only a small mounting area. They are suitable for lithium-ion secondary battery protection circuits and notebook PCs.

- Applications
- Lithium-ion secondary battery protection circuits
- Notebook PCs ● Portable electronic devices
- DC-DC converters

TO-220SM(W) Series ($V_{DSS} = 40\text{ V to }150\text{ V}$)

The TO-220SM package, which uses Cu connectors and a wide source terminal, realizes low ON-resistance and a high current-carrying capability.

- Applications
- Motor drivers ● Switching power supplies

Low- V_{DSS} , High- Q_g U-MOS Series ($V_{DSS} = 40\text{ V to }100\text{ V}$)

High integration is achieved using a trench technology. Low-voltage drive ($V_{GS} = 4\text{ V}$) is possible due to ultra-low ON-resistance.

- Applications
- Motor drivers ● Solenoids and lamp drivers

U-MOS Series for Synchronous Rectification ($V_{DSS} = 60\text{ V to }150\text{ V}$)

Fabricated using a trench technology, the U-MOS Series is ideal for synchronous rectification on the secondary side of power supply circuits.

- Applications
- Switching power supplies ● AC adapters
- Motor drivers

New π -MOSVII Series ($V_{DSS} = 450\text{ V to }650\text{ V}$)

The latest addition to the π -MOS portfolio, the π -MOSVII Series offers reduced capacitances due to optimized chip design and is available with a greatly wider range of electrical characteristics.

- Applications
- Switching power supplies ● AC adapters

Super-Junction DTMOS Series ($V_{DSS} = 600, 650\text{ V}$)

The super-junction DTMOS Series achieves low ON-resistance and low gate charge (Q_g) due to the use of the latest super-junction structure.

- Applications
- Switching power supplies ● AC adapters
- Motor drivers

High-Speed π -MOS Series ($V_{DSS} = 450\text{ V to }600\text{ V}$)

The new High-Speed π -MOS Series achieves higher switching speed than the well-proven π -MOS Series. Two series are available: high-speed switching series and high-speed diode series.

- Applications
- Inverters ● Switching power supplies
- Motor drivers ● AC adapters

2-2 Part Numbering Schemes

Small-Signal MOSFET (SSM) Series

SSM 3 K 101 TU

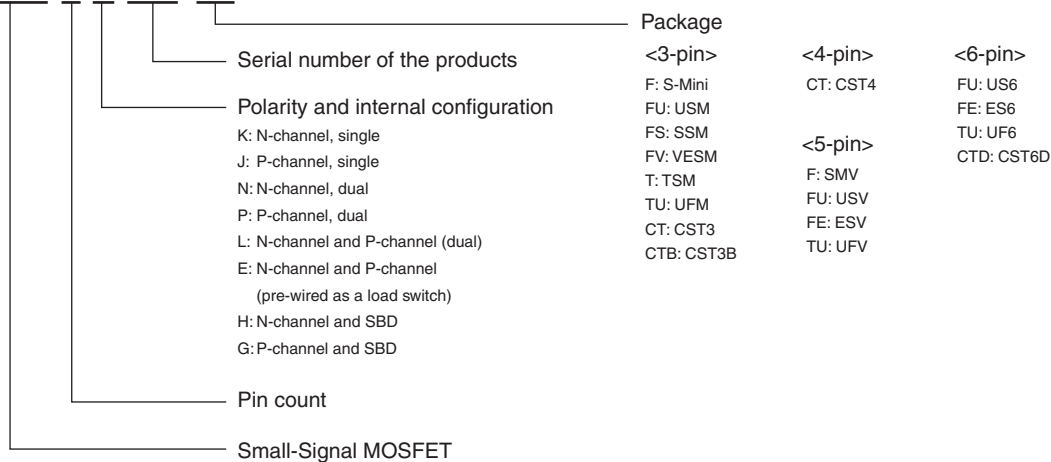

Multi-Pin Series

TPCM8 0 01 -H

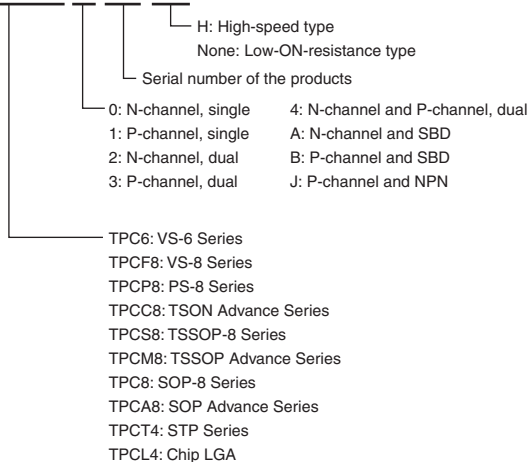

New Series

TK 55 A 10 J 1

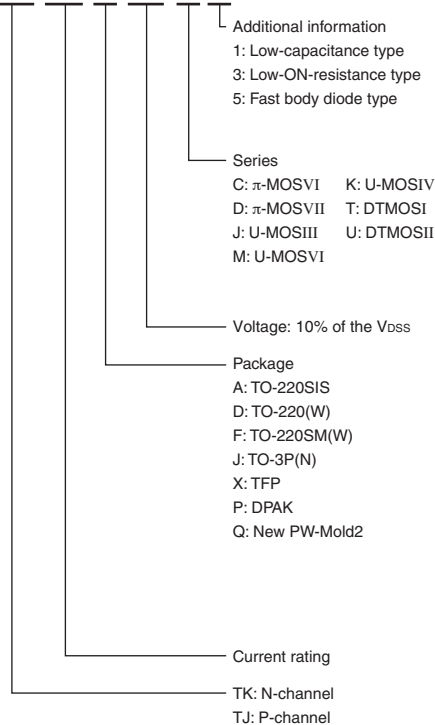

Conventional Series

2SK****

N-channel MOS

2SJ****

P-channel MOS

V _{DSS} (V) I _D (A)	12	20	24	30	40	50	60	100	150	180	200	250	400	450	500	525	550	600	650	V _{DSS} (V) I _D (A)	
0.05						*2SJ343(50) ^① *2SJ344(50) ^①														0.05	
0.1		*SSM3K04FU(12) ^② *SSM3K16FU(15) ^③ *SSM3J16FU(45) ^④ *SSM3K04FS(12) ^⑤ *SSM3K16FS(15) ^⑥ *SSM3J16FS(45) ^⑦ *SSM3J35FS(44) ^⑧ *SSM3K03FV(12) ^⑨ *SSM3K04FV(12) ^⑩ *SSM3K16FV(15) ^⑪ *SSM3J16FV(45) ^⑫ *SSM3J35MFV(44) ^⑬ *SSM3K16CT(15) ^⑭ *SSM3J16CT(45) ^⑮ *SSM3J35CT(44) ^⑯ *SSM6N04FU(12) ^⑰ *SSM6N16FU(15) ^⑱ *SSM6P16FU(45) ^⑲ *SSM6P35FU(44) ^⑳ *SSM6N03FE(12) ^㉑ *SSM6N16FE(15) ^㉒ *SSM6P16FE(45) ^㉓ *SSM6L16FE(15) ^㉔ *SSM6P35FE(45) ^㉕ *SSM5N16FU(15) ^㉖ *SSM5P16FU(45) ^㉗ *SSM5N03FE(12) ^㉘ *SSM5N16FE(15) ^㉙ *SSM5P16FE(45) ^㉚		*SSM3K15F(7) ^① *SSM3J15F(32) ^② *SSM3K15FU(7) ^③ *SSM3J15FU(32) ^④ *SSM3K15FS(7) ^⑤ *SSM3J15FS(32) ^⑥ *SSM3K15FV(7) ^⑦ *SSM3J15FV(32) ^⑧ *SSM3K15CT(7) ^⑨ *SSM3J15CT(32) ^⑩ *SSM6N15FU(7) ^⑪ *SSM6P15FU(32) ^⑫ *SSM5N15FU(7) ^⑬ *SSM5P15FU(32) ^⑭ *SSM6N15FE(7) ^⑮ *SSM6P15FE(32) ^⑯ *SSM5N15FE(7) ^⑰ *SSM5P15FE(32) ^⑱ *SSM3K44FS(7) ^㉑ *SSM3K44MFV(7) ^㉒ *SSM6N44FU(7) ^㉓ *SSM6N44FE(7) ^㉔			*SSM3K17FU(40) ^① *SSM6N17FU(40) ^②														0.1
0.18		*SSM3K35FS(20) ^① *SSM3K35MFV(20) ^② *SSM3K35CT(20) ^③ *SSM6N35FU(20) ^④ *SSM6L35FU(20) ^⑤ *SSM6N35FE(20) ^⑥ *SSM6L35FE(20) ^⑦																			0.18
0.2		*SSM3J05FU(4) ^① *SSM6P05FU(4) ^② *SSM5P05FU(4) ^③		*2SJ305(4) ^① *2SK2009(2) ^② *SSM3J09FU(4.2) ^③ *SSM6P09FU(4.2) ^④		*SSM3K7002BF(3.3) ^① *SSM6N7002BFU(3.3) ^② *SSM3K7002BFS(3.3) ^③ *SSM6N7002BFSU(3.3) ^④ *SSM3K7002F(3.3) ^⑤ *SSM6N7002AFU(3.3) ^⑥ *SSM3K7002AF(3.3) ^⑦ *2SJ168(2) ^⑧ *SSM3K7002FU(3.3) ^⑨ *2SK1062(1) ^⑩ *SSM3K7002AFU(3.3) ^⑪ *SSM6N7002BFE(3.3) ^⑫															0.2
0.25		*SSM6N37CTD(5.6) ^①																			0.25
0.33		*SSM3J36TU(3.6) ^① *SSM3J36FS(3.6) ^② *SSM3J36MFV(3.6) ^③ *SSM6P36TU(3.6) ^④ *SSM6P36FE(3.6) ^⑤																			0.33
0.4		*SSM6L05FU(1.2) ^① *SSM6N05FU(1.2) ^② *SSM3K05FU(1.2) ^③ *SSM5N05FU(1.2) ^④		*SSM6L09FU(1.2) ^① *SSM6N09FU(1.2) ^② *SSM3K09FU(1.2) ^③																	0.4
0.5		*SSM4K27CT(0.205) ^① *SSM6L10TU(0.145) ^② *SSM6L11TU(0.145) ^③ *SSM6L12TU(0.145) ^④ *SSM6N25TU(0.145) ^⑤ *SSM6N36TU(1.52) ^⑥ *SSM6P25TU(0.26) ^⑦ *SSM6P26TU(0.23) ^⑧ *SSM6J25FE(0.26) ^⑨ *SSM6J26FE(0.23) ^⑩ *SSM6K25FE(0.145) ^⑪ *SSM6L36TU(1.52) ^⑫ *SSM3K36FS(1.52) ^⑬ *SSM3K36MFV(1.52) ^⑭ *SSM3K36TU(1.52) ^⑮ *SSM6N36FE(1.52) ^⑯ *SSM6L36FE(1.52) ^⑰ *SSM6N43FU(1.52) ^⑱ *SSM3K43FS(1.52) ^㉑		*SSM6N24TU(0.145) ^① *SSM6K24FE(0.145) ^②											*2SK2998 (20) ^① *2SK3302 (18) ^② *2SK3471 (18) ^③					0.5	
0.65		*SSM6J06FU(0.5) ^①																			0.65
0.72		*SSM6P41FE(0.3) ^①																			0.72
0.77		*SSM6N42FE(0.26) ^①																			0.77
0.8		*SSM6L13TU(0.143) ^① *SSM6N29TU(0.143) ^② *SSM6P28TU(0.234) ^③ *SSM6J205FE(0.234) ^④		*SSM6J07FU(0.8) ^①																	0.8

Legend **Product series** ①: π-MOSIII ②: π-MOSV ③: π-MOSVI ④: L²-π-MOSV ⑤: L²-π-MOSVI ⑥: U-MOS ⑦: π-MOSVII ⑧: π-MOSIV ⑨: DTMOSI ⑩: DTMOSII

Package ◊PW-Mini ◊VS-8 ♥VS-6 ♣PS-8 ◊STP ▲TO-92MOD ▼PW-Mold J New PW-Mold ⊙TSON Advance ◊New PW-Mold2 ▽DP ☆TPS ◊TSSOP Advance ✂TSSOP-8 ★SOP-8 ◊SOP-8 Lead Clamp ▶SOP Advance ◆TO-220NIS ⊗TO-220SIS ■TO-220AB ◻TO-220(W) ♣TFP ○TO-220FL/SM ◊TO-220SM(W) ◻TO-3P(N) ⊙TO-3P(N)IS ●TO-3P(L) ◻Chip LGA *S-Mini ◊TSM *USM △UFM ☆SSM ◊VESH ◊CST3 ◊CST3B ◊CST4 ◊SMV ◊US6 *UF6 ◊ES6 *CST6D ◊USV *UFV ◊ESV

Notes:
 () = R_{DS(on)} max
 \$ = 10-V drive
 # = 2.5-V drive
 * = 1.8-V drive
 † = High-speed diode
 N = N-ch
 P = P-ch
 CN = Complementary N-ch
 CP = Complementary P-ch
 NS = N-ch + SBD
 PS = P-ch + SBD
 PD = P-ch + Driver (load switch)
 [] = Under development

V _{DS} (V) I _o (A)	12	20	24	30	40	50	60	100	150	180	200	250	400	450	500	525	550	600	800	900	1000	V _{DS} (V) I _o (A)		
1	PS *SSM5G02TU (0.16)Ⓢ PS *SSM5G04TU (0.24)Ⓢ PD *SSM6E01TU (0.16)Ⓢ	△SSM3J111TU (0.48)Ⓢ		PS *SSM5G01TU (0.8)Ⓢ			◇ 2SJ360 (0.73)Ⓢ ▲ 2SJ507 (0.7)Ⓢ	◇ 2SK2963 (0.7)Ⓢ ▲ 2SK2962 (0.7)Ⓢ ◇ 2SJ508 (1.9)Ⓢ ▲ 2SJ509 (1.9)Ⓢ	▲ 2SK3670 (1.7)	◆ 2SJ313 (5.0) ▼ 2SJ338 (5.0) ◆ 2SK2013 (5.0) ▼ 2SK2162 (5.0)	◇ 2SK2992 (3.5)Ⓢ	CP *TPC8404(2.55)Ⓢ CN *TPC8404(1.7)Ⓢ	▼ 2SK3498 (5.5)Ⓢ	⌈ 2SK4023 (4.6)Ⓢ ☆ 2SK3374 (4.6)Ⓢ ▼ 2SK3472 (4.6)Ⓢ				⌈ 2SK3371 (9)Ⓢ ⌈ 2SK4026 (9)Ⓢ		■ 2SK2733 (9.0)Ⓢ ▼ 2SK2845 (9)Ⓢ ▼ 2SK3301 (20)Ⓢ			1	
1.1		△SSM6K06FU (0.16)Ⓢ		△SSM3J112TU (0.79)Ⓢ																			1.1	
1.2	▲ SSM6J23FE (0.16)Ⓢ	△SSM3K106TU (0.53)Ⓢ ● SSM6P54TU (0.228)Ⓢ NS *SSM5H07TU (0.54)Ⓢ ▲ SSM6K31FE (0.54)Ⓢ ▲ SSM6K30FE (0.42)Ⓢ																					1.2	
1.3		△SSM6J08FU (0.18)Ⓢ PS *TPC8BA1 (0.18)Ⓢ		▲ SSM6J207FE (0.491)Ⓢ							⌈ TPCS8004-H (0.8)Ⓢ												1.3	
1.4	NS *SSM5H03TU (0.3)Ⓢ	▲ SSM6K22FE (0.17)Ⓢ		△SSM3J118TU (0.48)Ⓢ ● SSM6P40TU (0.403)Ⓢ PS *SSM5G11TU (0.403)Ⓢ NS *SSM5H01TU (0.45)Ⓢ ▲ SSM6K210FE (0.371)Ⓢ																			1.4	
1.5	PS *SSM5G09TU (0.13)Ⓢ	△SSM3K107TU (0.41)Ⓢ ● SSM6P39TU (0.213)Ⓢ NS *SSM5H05TU (0.16)Ⓢ NS *SSM5H08TU (0.16)Ⓢ		⊖ SSM3J02T (0.5)Ⓢ △SSM3K128TU (0.36)Ⓢ PS *SSM5G10TU (0.213)Ⓢ △SSM6K07FU (0.22)Ⓢ																			1.5	
1.6		▲ SSM6N42FE (0.252)Ⓢ NS *SSM5H10TU (0.119)Ⓢ NS *TPC8AA1 (0.105)Ⓢ ● SSM6L39TU (0.119)Ⓢ ● SSM6N39TU (0.119)Ⓢ △SSM6K08FU (0.105)Ⓢ		⊖ SSM3J313T (0.268)Ⓢ NS *SSM5H11TU (0.182)Ⓢ ● SSM6L40TU (0.182)Ⓢ ● SSM6N40TU (0.182)Ⓢ																			1.6	
1.7		△SSM3J113TU (0.169)Ⓢ		⊖ SSM3J01T (0.4)Ⓢ ⊖ SSM3J305T (0.477)Ⓢ																			1.7	
1.8	PD *SSM6E03TU (0.144)Ⓢ	△SSM3J108TU (0.158)Ⓢ △SSM3J114TU (0.149)Ⓢ PD *SSM6E02TU (0.136)Ⓢ ▲ SSM6J53FE (0.136)Ⓢ										★ TPC8012-H (0.4)Ⓢ											1.8	
1.9				NS *SSM5H12TU (0.133)Ⓢ ▲ SSM6K208FE (0.133)Ⓢ																			1.9	
2		△SSM3J109TU (0.13)Ⓢ △SSM3K122TU (0.123)Ⓢ ● SSM6K405TU (0.126)Ⓢ ▲ SSM6J206FE (0.13)Ⓢ ▲ SSM6K204FE (0.126)Ⓢ ⊖ SSM3J46CTB (0.103)Ⓢ * SSM3J325F (0.155)Ⓢ		△SSM3J117TU (0.225)Ⓢ △SSM3K127TU (0.123)Ⓢ ● SSM6J402TU (0.225)Ⓢ				◇ 2SK2615 (0.3)Ⓢ ▲ 2SK2961 (0.3)Ⓢ ◇ 2SK3658 (0.3)Ⓢ ● SSM6K407TU (0.44)Ⓢ ● SSM6K32TU (0.44)Ⓢ						▼ 2SJ610 (2.55)Ⓢ	⊗ 2SK3757 (2.45)Ⓢ ⊗ 2SK3766 (2.45)Ⓢ	☆ 2SK2599 (3.2)Ⓢ ⌈ 2SK3373 (3.2)Ⓢ			☆ 2SK2846 (5.0)Ⓢ ⌈ 2SK2865 (5.0)Ⓢ ⊗ 2SK3767 (4.5)Ⓢ ⌈ 2SK4002 (5)Ⓢ ⌈ TK2Q60D (4.3)Ⓢ				2	
2.1				△SSM3K116TU (0.1)Ⓢ																			2.1	
2.2		△SSM3J115TU (0.098)Ⓢ △SSM3K101TU (0.103)Ⓢ		△SSM3K105TU (0.2)Ⓢ				▲ TPC8003-H (0.18)Ⓢ ★ TPC8214-H (0.18)Ⓢ															2.2	
2.3	△SSM3J110TU (0.094)Ⓢ ⊖ SSM3J304T (0.127)Ⓢ			▲ SSM6K202FE (0.085)Ⓢ																			2.3	
2.4				⊖ SSM3J306T (0.225)Ⓢ △SSM3K124TU (0.12)Ⓢ																			2.4	
2.5		● SSM6J50TU (0.064)Ⓢ		△SSM3K119TU (0.074)Ⓢ ⊖ SSM3K02T (0.2)Ⓢ ● SSM6J401TU (0.145)Ⓢ			⊖ SSM3K318T (0.145)Ⓢ																2.5	
2.6		△SSM3K102TU (0.071)Ⓢ																					2.6	
2.7	⊖ SSM3J312T (0.091)Ⓢ	P# *TPC6105 (0.11)Ⓢ P# *TPCF8301 (0.11)Ⓢ PS# *TPCF8B01 (0.11)Ⓢ P# *TPCF8103 (0.11)Ⓢ		⊖ SSM3J14T (0.17)Ⓢ																			2.7	
2.8		▲ SSM6K203FE (0.061)Ⓢ																					2.8	
2.9				⊖ SSM3K303T (0.12)Ⓢ																			2.9	
3	⊖ SSM3J13T (0.07)Ⓢ ● SSM6J21TU (0.05)Ⓢ	N# *TPCF8201 (0.049)Ⓢ NS# *TPCF8A01 (0.049)Ⓢ P# *TPCF8302 (0.059)Ⓢ P# *TPCF8303 (0.058)Ⓢ △SSM3K104TU (0.056)Ⓢ ● SSM6K404TU (0.055)Ⓢ		⊖ SSM3K12T (0.175)Ⓢ ● SSM6K34TU (0.077)Ⓢ NS *SSM5H14F (0.078)Ⓢ				☆ 2SK2200 (0.35)Ⓢ ☆ 2SK2201 (0.35)Ⓢ ⌈ 2SK4018 (0.35)Ⓢ					⌈ 2SK3462 (1.7)Ⓢ ⌈ 2SK4022 (1.7)Ⓢ			◆ 2SK2862 (3.2)Ⓢ			⌈ 2SK4003 (2.2)Ⓢ ⌈ (Short lead) ⌈ 2SK3975 (2.2)Ⓢ	■ 2SK2603 (3.6)Ⓢ ○ 2SK2883 (3.6)Ⓢ	■ 2SK2608 (4.3)Ⓢ □ 2SK2719 (4.3)Ⓢ ⊗ 2SK3564 (4.3)Ⓢ			3
3.2		△SSM3K121TU (0.048)Ⓢ ▲ SSM6K211FE (0.047)Ⓢ		CP# *TPCF8402 (0.077)Ⓢ P# *TPCF8304 (0.072)Ⓢ ⊖ SSM3K01T (0.12)Ⓢ																			3.2	
3.3		▲ SSM6J212FE (0.0434)Ⓢ																					3.3	
3.4				CP# *TPCF8402 (0.072)Ⓢ				P# *TPCF8403 (0.070)Ⓢ															3.4	
3.5		⊖ SSM3K301T (0.056)Ⓢ * SSM3J327F (0.095)Ⓢ		⊖ SSM3J314T (0.1)Ⓢ																			3.5	
3.6		⊖ SSM3J317T (0.107)Ⓢ																					3.6	
3.8		P# *TPCF8303 (0.04)Ⓢ																					3.8	
3.9																							3.9	
4	● SSM6J51TU (0.054)Ⓢ	△SSM3J120TU (0.038)Ⓢ ● SSM6K18TU (0.04)Ⓢ		CN# *TPCF8402 (0.05)Ⓢ CN# *TPCF8404 (0.05)Ⓢ CP# *TPCF8404 (0.05)Ⓢ ⊖ SSM3K316T (0.065)Ⓢ ⊖ SSM3K14T (0.067)Ⓢ																			4	

Legend Product series ① : π-MOSIII ② : π-MOSV ③ : π-MOSVI ④ : L²-π-MOSV ⑤ : L²-π-MOSVI ⑥ : U-MOS ⑦ : π-MOSVII ⑧ : π-MOSIV ⑨ : DTMOI ⑩ : DTMOII Package ◇PW-Mini ⌈VS-8 ♥VS-6 ♣PS-8 ⊕STP ▲TO-92MOD ▼PW-Mold ⌈New PW-Mold ⊙TSOP Advance ⌈New PW-Mold2 ▽DP ☆TPS ◀TSSOP Advance ⌈TSSOP-8 ★SOP-8 ⊙SOP-8 Lead Clamp ▶SOP Advance ◆TO-220NIS ⊗TO-220SIS ■TO-220AB □TO-220(W) ♣TFP ○TO-220FL/SM ⌈TO-220SM(W) □TO-3P(N) ⊙TO-3P(N)IS ●TO-3P(L) ⊕Chip LGA *S-Mini ⊖TSM *USM △UFM ☆SSM ⊖VESM ⊖CST3 ⊖CST3B ⊖CST4 ⊖SMV ⊖US6 *UF6 ⊖ES6 *CST6D ⊖USV *UFV ⊖ESV

Notes: () = R_{DS(on)} max () = High-speed diode \$ = 10-V drive # = 2.5-V drive * = 1.8-V drive P = P-ch CN = Complementary N-ch PS = P-ch + SBD NS = N-ch + SBD PD = P-ch + Driver (load switch) [] = Under development

V _{DSS} (V) I _D (A)	12	20	24	30	40	50	60	100	150	180	200	250	400	450	500	525	550	600	650	700	800	900	1000	V _{DSS} (V) I _D (A)				
4.2		△SSM3K123TU (0.028)Ⓢ ●SSM6K403TU (0.028)Ⓢ		N★TPCP8201 (0.05)Ⓢ CN★TPCP8402 (0.077)Ⓢ +SSM3K320T (0.077)Ⓢ																					4.2			
4.4		△SSM3J130TU (0.025)Ⓢ		●SSM6K406TU (0.038)Ⓢ																					4.4			
4.5		P★TPC6107 (0.055)Ⓢ		P★TPC6108 (0.06)Ⓢ CP★TPC8405 (0.033)Ⓢ								J 2SK3342 (1.0)Ⓢ J 2SK4021 (1.0)Ⓢ													4.5			
4.6		△SSM3J129TU (0.046)Ⓢ																							4.6			
4.7		+SSM3K309T (0.031)Ⓢ																							4.7			
4.8																									4.8			
5	△SSM3J32TU (0.0178)Ⓢ	★TPC8208 (0.05)Ⓢ I TPC8209 (0.03)Ⓢ N# I TPC8210 (0.03)Ⓢ P# I TPC8303 (0.021)Ⓢ P I TPC8302 (0.035)Ⓢ P★TPC8301 (0.031)Ⓢ P★TPC8302 (0.033)Ⓢ +SSM3J307T (0.031)Ⓢ +SSM3K310T (0.028)Ⓢ		I TPC8209 (0.05)Ⓢ N# I TPC8001 (0.032)Ⓢ P★TPC8104-H (0.065)Ⓢ N# I TPC6007-H (0.054)Ⓢ P I TPC6109-H (0.059)Ⓢ		▲2SK2989 (0.15)Ⓢ ▲2SJ537 (0.19)Ⓢ	J 2SJ668 (0.17)Ⓢ J 2SJ681 (0.17)Ⓢ ☆2SJ378 (0.19)Ⓢ ☆2SJ669 (0.17)Ⓢ ◆2SJ438 (0.19)Ⓢ ☆2SK2229 (0.16)Ⓢ J 2SK4017 (0.1)Ⓢ J 2SK4033 (0.1)Ⓢ ★TPC8213-H (0.05)Ⓢ	J 2SK2399 (0.23)Ⓢ ☆2SK2400 (0.23)Ⓢ J 2SK4019 (0.23)Ⓢ	▼2SK3205 (0.52)		◆2SJ407 (1.0)Ⓢ ◆2SK2381 (0.8)Ⓢ ☆2SK2835 (0.8)Ⓢ J 2SK2920 (0.8)Ⓢ J 2SK4020 (0.8)Ⓢ	◆2SJ512 (1.25)Ⓢ			○2SK2991 (1.5)Ⓢ ◆2SK3466 (1.5)Ⓢ ▽2SK3863 (1.5)Ⓢ J 2SK4103 (1.5)Ⓢ Y○2SK3417 (1.8)Ⓢ Y○2SK3868 (1.7)Ⓢ ○TK5A50D (1.5)Ⓢ		⊗TK5A55D (1.88)Ⓢ		⊗TK5A65D (1.45)Ⓢ	◆2SK2274 (1.7)	○2SK2884 (2.2)Ⓢ	⊗2SK3565 (2.5)Ⓢ □2SK3700 (2.5)Ⓢ ⊗2SK3742 (2.5)Ⓢ	□2SK1359 (3.8)		5			
5.2		+SSM3J321T (0.046)Ⓢ																							5.2			
5.5	PD★TPC8401 (0.038)Ⓢ P★TPC6103 (0.035)Ⓢ	P★TPC6111 (0.04)Ⓢ		N★TPC8211 (0.036)Ⓢ N★TPC8202 (0.023)Ⓢ								N▶TPCA8010-H (0.45)Ⓢ	○2SK2838 (1.2)Ⓢ ◆2SK2679 (1.2)Ⓢ								⊗TK6A55DA (1.48)Ⓢ				5.5			
5.6		P★TPC8101 (0.030)Ⓢ		+SSM3J326T (0.0457)Ⓢ																					5.6			
6	P★TPCF8101 (0.028)Ⓢ	N▶TPCT4201 (0.031)Ⓢ N▶TPCT4203 (0.031)Ⓢ N#▶TPC6004 (0.024)Ⓢ P★TPCF8102 (0.030)Ⓢ ★TPC8207 (0.02)Ⓢ I TPC8211 (0.024)Ⓢ I TPC8204 (0.017)Ⓢ P# I TPC8102 (0.02)Ⓢ P# I TPC8302 (0.035)Ⓢ N# I TPC8212 (0.024)Ⓢ N# I TPC8208 (0.017)Ⓢ N I TPC8213 (0.013)Ⓢ N▶TPCL4201 (0.031)Ⓢ	N▶TPCL4203 (0.036)Ⓢ	N▶TPCT4202 (0.038)Ⓢ N▶TPCT4204 (0.038)Ⓢ N#▶TPC6011 (0.020)Ⓢ N#▶TPC6005 (0.028)Ⓢ PD▶TPCP801 (0.03)Ⓢ P▶TPC8104 (0.028)Ⓢ N I TPC8214 (0.135)Ⓢ NS★TPC8A01 (0.025)Ⓢ ★TPC8212-H (0.021)Ⓢ CN★TPC8405 (0.026)Ⓢ +SSM3K315T (0.0415)Ⓢ N▶TPCL4202 (0.04)Ⓢ △SSM3K131TU (0.0415)Ⓢ										◆2SJ516 (0.8)Ⓢ		⊗TK6A50D (1.48)Ⓢ	⊗TK6A53D (1.3)Ⓢ ▽TK6P53D (1.3)Ⓢ				□2SK2602 (1.25)Ⓢ ○2SK2777 (1.25)Ⓢ ◆2SK3312 (1.25)Ⓢ ⊗TK6A60D (1.25)Ⓢ Y⊗2SK3947 (1.4)Ⓢ	⊗TK6A65D (1.11)Ⓢ		⊗2SK4013 (1.7)Ⓢ	⊗2SK4014 (2.0)Ⓢ			6
6.5				N★TPC8216-H (0.020)Ⓢ																					6.5			
7				N▶TPCF8001 (0.023)Ⓢ N▶TPCF8002 (0.023)Ⓢ	CNTPC8406-H (0.027)Ⓢ CP TPC8406-H (0.03)Ⓢ																				7			
7.2		P★TPCP8102 (0.018)Ⓢ		N▶TPC8001-H (0.016)Ⓢ																					7.2			
7.5				N▶TPCA8020-H (0.027)Ⓢ N★TPC8022-H (0.027)Ⓢ P★TPC8116-H (0.03)Ⓢ P▶TPCA8107-H (0.03)Ⓢ									◆2SK2417 (0.5)Ⓢ ■2SK2914 (0.5)Ⓢ									⊗TK6A55DA (1.07)Ⓢ ⊗TK6A60DA (1.0)Ⓢ				7.5		
8				N★TPC8210 (0.015)Ⓢ N★TPC8021-H (0.017)Ⓢ	P★TPC8110 (0.025)Ⓢ																				8			
8.3				N▶TPCP8004 (0.009)Ⓢ																					8.3			
8.5				NS★TPC8A01 (0.018)Ⓢ																					8.5			
9		N▶TPC8006 (0.01)Ⓢ																							9			
9.5		●SSM6J409TU (0.0221)Ⓢ																							9.5			
10		P★TPC8115 (0.01)Ⓢ		P★TPC8109 (0.02)Ⓢ P★TPC8119 (0.012)Ⓢ NS▶TPCA805-H (0.012)Ⓢ							J 2SK3669 (0.125)Ⓢ		□2SJ200 (0.83) □2SK1529 (0.83) □2SK3497 (0.15) □2SJ618 (0.37)													10		

Legend

Product series ①: π-MOSIII ②: π-MOSV ③: π-MOSVI ④: L²-π-MOSV ⑤: L²-π-MOSVI ⑥: U-MOS ⑦: π-MOSVII ⑧: π-MOSIV ⑨: DTMOSI ⑩: DTMOSII

Package ◊PW-Mini JVS-8 ♥VS-6 ♣PS-8 ⚡STP ▲TO-92MOD ▼PW-Mold J New PW-Mold ○TSON Advance J New PW-Mold2 ▽DP ☆TPS ◀TSSOP Advance X TSSOP-8 ★SOP-8 ◊SOP-8 Lead Clamp ▶SOP Advance ◆TO-220NIS ⊗TO-220SIS ■TO-220AB □TO-220(W) ⚡TFP ○TO-220FL/SM ⚡TO-220SM(W) □TO-3P(N) ○TO-3P(N)IS ●TO-3P(L) □Chip LGA

*S-Mini +TSM *USM △UFM ⊙SSM +VESM +CST3 ◊CST3B ⊙CST4 +SMV /US6 *UF6 +ES6 *CST6D \USV *UFV ☆ESV

Notes:
 () = Revision max
 \$ = 10-V drive
 # = 2.5-V drive
 * = 1.8-V drive
 Y = High-speed diode
 N = N-ch
 P = P-ch
 CN = Complementary N-ch
 CP = Complementary P-ch
 NS = N-ch + SBD
 PS = P-ch + SBD
 PD = P-ch + Driver (load switch)
 [] = Under development

V _{DSS} (V) I _D (A)	20	30	40	50	60	75	80	100	150	200	250	300	450	500	525	550	600	900/1000	V _{DSS} (V) I _D (A)		
11		N★TPC8025 (0.009)Ⓢ N★TPC8021-H (0.017)Ⓢ N★TPC8014 (0.014)Ⓢ P★TPC8111 (0.012)Ⓢ P★TPC8113 (0.01)Ⓢ P I TPC8105 (0.0135)Ⓢ P I TPC8104 (0.012)Ⓢ N★TPC8030 (0.0095) N★TPC8031-H (0.0133)Ⓢ N★TPC8005-H (0.0129)Ⓢ P★TPC8121 (0.012)Ⓢ P★TPC8123 (0.0090)Ⓢ				N○TPC8050-H (0.0145)Ⓢ					◆2SK2965 (0.26)Ⓢ							⊗TK11A55D (0.63)Ⓢ	⊗TK11A60D (0.65)Ⓢ		11
12		N○TPC8037-H (0.0114)Ⓢ N○TPC8038-H (0.0114)Ⓢ NS○TPC8A06-H (0.0101)Ⓢ	N○TPC8052-H (0.0115)Ⓢ					◆2SJ380 (0.21)Ⓢ		◆2SJ201 (0.625) ◆2SK1530 (0.625)				○2SK3068 (0.52)Ⓢ ◆2SK3398 (0.52)Ⓢ ⊗TK12A50D (0.52)Ⓢ ¥◆2SK3313 (0.62)Ⓢ	⊗TK12A53D (0.58)Ⓢ ◆TK12X53D (0.58)Ⓢ	□TK12J55D (0.57)Ⓢ	□2SK2699 (0.65)Ⓢ ⊗TK12A60U (0.4)Ⓢ ⊗TK12D60U (0.4)Ⓢ □TK12J60U (0.4)Ⓢ ⊗TK12A60D (0.55)Ⓢ	1000V: ◆2SK1489 (1.0)		12	
12.5														⊗TK13A50DA (0.47)Ⓢ						12.5	
13		N★TPC8041 (0.007)Ⓢ N★TPC8026 (0.0066)Ⓢ P★TPC8107 (0.007)Ⓢ P○TPC8112 (0.006)Ⓢ P○TPC8118 (0.007)Ⓢ N○TPC8003-H (0.0169)Ⓢ N○TPC8040-H (0.0097)Ⓢ				N○TPC8049-H (0.0107)Ⓢ		N○TPC8051-H (0.0097)Ⓢ			◆2SK2508 (0.25)Ⓢ ○2SK2598 (0.25)Ⓢ			◆2SK3743 (0.4)Ⓢ ○2SK3403 (0.4)Ⓢ ◆2SK3544 (0.4)Ⓢ ⊗TK13A45D (0.46)Ⓢ	⊗TK13A50D (0.4)Ⓢ			⊗TK13A60D (0.43)Ⓢ ¥⊗2SK4016 (0.5)Ⓢ	900V: □2SK4207 (0.95)		13
14					◆2SJ304 (0.12) 2SJ312 (0.12)									○2SK2916 (0.4)Ⓢ		⊗TK14A55D (0.37)Ⓢ	□2SK3903 (0.44)Ⓢ		14		
15		N○TPC8032-H (0.0065)Ⓢ P○TPC8102 (0.0189)Ⓢ			▶TPCA8053-H (0.0223)Ⓢ					◆2SK2382 (0.18)Ⓢ ○2SK2401 (0.18)Ⓢ				⊗TK15A50D (0.3)Ⓢ ¥□2SK3314 (0.49)Ⓢ □TK15J50D (0.4)Ⓢ			⊗2SK2953 (0.4)Ⓢ ⊗TK15A60U (0.3)Ⓢ ⊗TK15D60U (0.3)Ⓢ □TK15J60U (0.3)Ⓢ ⊗TK15A60D (0.37)Ⓢ		15		
16		NS★TPC8A02-H (0.0056)Ⓢ	N○TPC8047-H (0.0076)Ⓢ		N○TPC8048-H (0.0069)Ⓢ			○2SJ412 (0.21)Ⓢ ◆2SJ619 (0.21)Ⓢ									□TK16J55D (0.37)Ⓢ		16		
17		N○TPC8033-H (0.0053)Ⓢ NS○TPC8A03-H (0.0056)Ⓢ N○TPC8039-H (0.006)Ⓢ											⊗2SK3935 (0.25)Ⓢ	□2SK3905 (0.31)Ⓢ					17		
18		P○TPC8114 (0.0045)Ⓢ N★TPC8027 (0.0027)Ⓢ N★TPC8028 (0.0043)Ⓢ N★TPC8029 (0.0038)Ⓢ N○TPC8034-H (0.0035)Ⓢ N★TPC8042 (0.0034)Ⓢ P○TPC8117 (0.0039)Ⓢ N○TPC8036-H (0.0045)Ⓢ NS○TPC8A04-H (0.0036)Ⓢ P○TPC8120 (0.0032)Ⓢ P○TPC8103 (0.012)Ⓢ N○TPC8035-H (0.0032)Ⓢ N○TPC8060-H (0.0037)Ⓢ	N○TPC8045-H (0.0039)Ⓢ N○TPC8046-H (0.0057)Ⓢ				◆2SJ464 (0.12)Ⓢ ◆2SJ620 (0.09)Ⓢ ▶TPCA8006-H (0.067)	◆2SK2882 (0.12)Ⓢ ◆2SK3387 (0.12)Ⓢ							○2SK2917 (0.27)Ⓢ ⊗TK18A50D (0.27)Ⓢ					18	
19														□2SK3904 (0.26)Ⓢ					19		
20		NS★TPC8A05-H (0.0129)Ⓢ NS▶TPCA8A05-H (0.0129)Ⓢ N★TPCM8001-H (0.0095)Ⓢ	N▶TPCA8052-H (0.0115)Ⓢ	▽2SK2614 (0.046)Ⓢ	◆2SJ349 (0.045)Ⓢ ○2SJ401 (0.045)Ⓢ ▽2SK2782 (0.055)Ⓢ			◆2SK2391 (0.085)Ⓢ ⊗TJ20A10M3 (0.090)Ⓢ			○2SK2993 (0.105)Ⓢ ◆2SK3445 (0.105)Ⓢ ◆2SK3994 (0.105)Ⓢ				□TK20J50D (0.27)Ⓢ			□2SK3911 (0.32)Ⓢ ⊗TK20A60U (0.19)Ⓢ ⊗TK20D60U (0.19)Ⓢ □TK20J60U (0.19)Ⓢ ¥□2SK3906 (0.33)Ⓢ		20	
21		N★TPCM8003-H (0.0129)Ⓢ NS○TPC8A01-H (0.0099)Ⓢ																	21		
22		N○TPCC8001-H (0.0083)Ⓢ N○TPCC8002-H (0.0083)Ⓢ N○TPCC8006-H (0.008)Ⓢ						▶TPCA8022-H (0.026)Ⓢ											22		
23		N▶TPCA8040-H (0.0094)Ⓢ																□2SK3907 (0.23)Ⓢ ¥□2SK3936 (0.25)Ⓢ		23	

Legend **Product series** ①: π-MOSIII ②: π-MOSV ③: π-MOSVI ④: L²-π-MOSV ⑤: L²-π-MOSVI ⑥: U-MOS ⑦: π-MOSVII ⑧: π-MOSIV ⑨: DTMOI ⑩: DTMOII

Package ◊PW-Mini ↵VS-8 ♥VS-6 ♣PS-8 ⊕STP ▲TO-92MOD ▼PW-Mold ↓New PW-Mold ⊕TSON Advance ♪New PW-Mold2 ▽DP ☆TPS ◀TSSOP Advance ✕TSSOP-8 ★SOP-8
 ○SOP-8 Lead Clamp ▶SOP Advance ◆TO-220NIS ⊗TO-220SIS ■TO-220AB ⊞TO-220(W) ◆TFP ○TO-220FL/SM
 * S-Mini †TSM *USM △UFM ☆SSM †VESM †CST3 ◊CST3B ⊕CST4 †SMV ∠US6 *UF6 †ES6 *CST6D ^USV *UFV ⊕ESV

Notes:
 () = R_{DS(on)} max * = 1.8-V drive P = P-ch PS = P-ch + SBD PD = P-ch + Driver (load switch)
 \$ = 10-V drive † = High-speed diode CN = Complementary N-ch
 # = 2.5-V drive N = N-ch CP = Complementary P-ch [] = Under development

V _{DSS} (V) I _D (A)	20	30	40	50	60	75	80	100	150	200	250	300	450	500	525	550	600	900/1000	V _{DSS} (V) I _D (A)	
24		N ▶ TPC8004-H (0.011)Ⓢ N ▶ TPC8030-H (0.011)Ⓢ N ▶ TPC8031-H (0.011)Ⓢ			N ▶ TPC8050-H (0.014)Ⓢ														24	
25		P ◀ TPC8102 (0.0077)Ⓢ N ◀ TPC8006 (0.007)Ⓢ N ⊙ TPCC8008 (0.0068)Ⓢ		◆ 2SK2507 (0.046)Ⓢ	◆ 2SK2232 (0.046)Ⓢ ○ 2SK2311 (0.046)Ⓢ N ▶ TPC8016-H (0.021)Ⓢ				⊙ TK25A10K3 (0.040)Ⓢ		◆ 2SK3444 (0.082)Ⓢ ○ 2SK3625 (0.082)Ⓢ			● 2SK1544 (0.2)					25	
26		N ⊙ TPCC8005-H (0.0064)Ⓢ	◆ 2SK3846 (0.016)Ⓢ																26	
27	N ⊙ TPCC8007 (0.0046)Ⓢ																		27	
28					N ▶ TPC8049-H (0.0104)Ⓢ														28	
30		N ▶ TPC8018-H (0.0062)Ⓢ N ◀ TPC8002-H (0.0062)Ⓢ	N ▶ TPC8014-H (0.009)Ⓢ N ▶ TPC8027-H (0.010)Ⓢ		◆ 2SJ334 (0.038)Ⓢ ○ 2SJ402 (0.038)Ⓢ ⊙ TK30A06J3A (0.026)Ⓢ				◆ 2SK3443 (0.055)Ⓢ	□ 2SK3176 (0.052)Ⓢ	□ 2SK2967 (0.068)Ⓢ ⊙ 2SK2995 (0.068)Ⓢ								30	
32			○ 2SK3847 (0.016)Ⓢ N ▶ TPC8047-H (0.0073)Ⓢ											● 2SK1486 (0.095)					32	
34		NS ▶ TPC8A02-H (0.0053)Ⓢ N ▶ TPC8039-H (0.0057)Ⓢ																	34	
35		N ▶ TPC8024 (0.0043)Ⓢ	N ▶ TPC8015-H (0.0054)Ⓢ		◆ 2SK3662 (0.0125)Ⓢ N ▶ TPC8048-H (0.0066)Ⓢ														35	
36					◆ 2SK2385 (0.03)Ⓢ														36	
38		NS ▶ TPC8A08-H (0.0042)Ⓢ N ▶ TPC8036-H (0.0038)Ⓢ	N ▶ TPC8046-H (0.0054)Ⓢ																38	
40	N ▶ TPC8011-H (0.0035)Ⓢ	P ▶ TPC8102 (0.006)Ⓢ P ▶ TPC8103 (0.0042)Ⓢ P ▶ TPC8106 (0.0037)Ⓢ N ▶ TPC8012-H (0.0049)Ⓢ N ▶ TPC8025 (0.0036)Ⓢ N ▶ TK40P03M1 (0.0108)Ⓢ	P ▶ TPC8108 (0.0095)Ⓢ N ▶ TK40P04M1 (0.011)Ⓢ		P ▶ TPC8104 (0.016)Ⓢ	⊙ TK40A08K3 (0.009)Ⓢ			⊙ TK40D10J1 (0.015)Ⓢ ⊙ TK40A10J1 (0.015)Ⓢ ⊙ TK40A10K3 (0.015)Ⓢ ◆ TK40X10J1 (0.020)Ⓢ									□ TK40J60T (0.08)Ⓢ	40	
44		NS ▶ TPC8A04-H (0.0032)Ⓢ																	44	
45		□ 2SK3506 (0.02) N ▶ TPC8019-H (0.0031)Ⓢ N ▶ TPC8026 (0.0022)Ⓢ N ▶ TPC8042 (0.0033)Ⓢ N ▶ TPC8060-H (0.0034)Ⓢ		□ 2SK2550 (0.03)Ⓢ ◆ 2SK2886 (0.02)Ⓢ □ 2SK2744 (0.02)Ⓢ □ 2SK3051 (0.03)Ⓢ	□ 2SK2233 (0.03)Ⓢ ○ 2SK2266 (0.03)Ⓢ ○ 2SK2376 (0.017)Ⓢ □ 2SK2398 (0.03)Ⓢ ◆ 2SK3844 (0.0058)Ⓢ															45
46			N ▶ TPC8045-H (0.0036)Ⓢ																46	
50		N ▶ TPC8028-H (0.0028)Ⓢ N ▶ TK50P03M1 (0.0075)Ⓢ	N ▶ TK50P04M1 (0.0087)Ⓢ	□ 2SK2551 (0.011)Ⓢ □ 2SK2745 (0.0095)Ⓢ	□ 2SK2173 (0.017)Ⓢ □ 2SK2445 (0.018)Ⓢ				□ 2SK1381 (0.032)	◆ TK50X15J1 (0.03)Ⓢ ◆ TK50F15J1 (0.03)Ⓢ				● 2SK3132 (0.09)Ⓢ ◆ 2SK3131 (0.11)Ⓢ					50	
55																			55	
60					● 2SK2267 (0.011)Ⓢ □ 2SK2313 (0.011)Ⓢ	⊙ TK60D08J1 (0.0078)Ⓢ ⊙ TK60A08J1 (0.0078)Ⓢ			● 2SK1382 (0.020)										60	
70			□ TK70J04J3 (0.0038)Ⓢ ◆ TK70X04K3 (0.0056)Ⓢ ◆ TK70X04K3L (0.0056)Ⓢ		□ 2SK3845 (0.0058)Ⓢ ⊙ TK70D06J1 (0.0064)Ⓢ ⊙ TK70A06J1 (0.0064)Ⓢ ⊙ TJ70A06J3 (0.008)Ⓢ ◆ TK70X06K3 (0.008)Ⓢ														70	
75			◆ 2SK3843 (0.0035)Ⓢ		◆ 2SK4034 (0.0058)Ⓢ ◆ 2SK3842 (0.0058)Ⓢ														75	
80			◆ TK80X04K3 (0.0035)Ⓢ			⊙ TK80A08K3 (0.0045)Ⓢ ⊙ TK80D08K3 (0.0045)Ⓢ													80	
100			◆ TK100F04K3 (0.003)Ⓢ ◆ TK100F04K3L (0.003)Ⓢ		◆ TK100F06K3 (0.005)Ⓢ														100	
120					◆ TJ120F06J3 (0.008)Ⓢ														120	
130					◆ TK130F06K3 (0.0034)Ⓢ														130	
150			◆ TK150F04K3 (0.0021)Ⓢ ◆ TK150F04K3L (0.0021)Ⓢ																150	

Legend **Product series** ① : π-MOSIII ② : π-MOSV ③ : π-MOSVI ④ : L²-π-MOSV ⑤ : L²-π-MOSVI ⑥ : U-MOS ⑦ : π-MOSVII ⑧ : π-MOSIV ⑨ : DTMOSI ⑩ : DTMOSII

Package ◊ PW-Mini ↗ VS-8 ♥ VS-6 ♣ PS-8 ⊕ STP ▲ TO-92MOD ▼ PW-Mold ↘ New PW-Mold ○ TSON Advance ◊ SOP-8 Lead Clamp ▶ SOP Advance ◆ TO-220NIS ⊙ TO-220SIS ■ TO-220AB ⊞ TO-220(W) ◆ TFP ○ TO-220FL/SM * S-Mini + TSM * USM △ UFM ☆ SSM + VESM + CST3 ◊ CST3B ◊ CST4 + SMV / US6 * UF6

⊞ New PW-Mold2 ▽ DP ☆ TPS ◀ TSSOP Advance ✕ TSSOP-8 ★ SOP-8 ◆ TO-220SM(W) □ TO-3P(N) ○ TO-3P(N)IS ● TO-3P(L) ⊞ Chip LGA + ES6 * CST6D △ USV * UFV ☆ ESV ▷ DPAK

Notes:
 () = R_{DS(on)} max * = 1.8-V drive P = P-ch NS = N-ch + SBD PD = P-ch + Driver
 \$ = 10-V drive ¥ = High-speed diode CN = Complementary N-ch PS = P-ch + SBD (load switch)
 # = 2.5-V drive N = N-ch CP = Complementary P-ch [] = Under development

4-1 Packaging Options

SSM Series

The SSM Series comes in small, thin packages suitable for portable devices. Chip-scale packages (1006 size) help reduce system size.

CST3 Chip-Scale Package, Transfer Molded, 3-Pin Typical product: SSM3K35CT Thickness: 0.38 typ. Unit: mm	CST3B Chip-Scale Package, Transfer Molded, 3-Pin, B-Type Typical product: SSM3J46CTB Thickness: 0.48 typ. Unit: mm	VESM (SOT-723) Very Extreme Super-Mini Typical product: SSM3K35MFV Thickness: 0.5 typ. Unit: mm	SSM (SOT-416)(SC-75) Small Super-Mini Typical product: SSM3K35FS Thickness: 0.7 typ. Unit: mm	USM (SOT-323)(SC-70) Ultra-Super-Mini Typical product: SSM3K15FU Thickness: 0.9 typ. Unit: mm
UFM Ultra-super-Mini Flat lead Typical product: SSM3J130TU Thickness: 0.7 typ. Unit: mm	S-Mini (SOT-346)(SC-59) Super-Mini Typical product: SSM3K15F Thickness: 1.1 typ. Unit: mm	TSM Thin Super-Mini Typical product: SSM3J304T Thickness: 0.7 typ. Unit: mm	CST4 Chip-Scale Package, Transfer Molded, 4-Pin Typical product: SSM4K27CT Thickness: 0.38 typ. Unit: mm	ESV (SOT-553) Extreme Super-mini, 5-pin Typical product: SSM5N15FE Thickness: 0.55 typ. Unit: mm
USV (SOT-353)(SC-88A) Ultra-Super-mini, 5-pin Typical product: SSM5N15FU Thickness: 0.9 typ. Unit: mm	UFV Ultra-super-mini, Flat lead, 5-pin Typical product: SSM5H12TU Thickness: 0.7 typ. Unit: mm	SMV (SOT-25)(SC-74A) Super-Mini, 5-pin Typical product: SSM5H14F Thickness: 1.1 typ. Unit: mm	CST6D Chip-Scale Package, Transfer Molded, 6-Pin, D-Type Typical product: SSM6N37CTD Thickness: 0.38 typ. Unit: mm	ES6 (SOT-563) Extreme Super-mini, 6-pin Typical product: SSM6N36FE Thickness: 0.55 typ. Unit: mm
US6 (SOT-353)(SC-88A) Ultra-Super-mini, 6-pin Typical product: SSM6N15FU Thickness: 0.9 typ. Unit: mm	UF6 Ultra Super mini Flat lead 6-pin Typical product: SSM6J409TU Thickness: 0.7 typ. Unit: mm			

TPC Series

The TPC Series comes in small, thin packages suitable for portable devices. The latest TSON Advance package allows the maximum permissible power dissipation equivalent to SOP-8, but occupies 64% less board space.

VS-6 Very Thin & Small, 6-pin Typical product: TPC6003 Thickness: 0.75 typ. Unit: mm	VS-8 Very Thin & Small, 8-pin Typical product: TPCF8101 Thickness: 0.8 typ. Unit: mm	PS-8 Progressive & Small 8-pin Series Typical product: TPCP8402 Thickness: 0.8 typ. Unit: mm	Chip LGA Land Grid Array Typical product: TPCL4201 Thickness: 0.25 typ. Unit: mm	STP2 Small Thin Package Typical product: TPCT4204 Thickness: 0.65 typ. Unit: mm
TSON Advance Typical product: TPCC8005-H Thickness: 0.85 typ. Unit: mm	TSSOP-8 Typical product: TPCS8208 Thickness: 0.9 typ. Unit: mm	TSSOP Advance Typical product: TPCM8001-H Thickness: 0.75 typ. Unit: mm	SOP-8 Typical product: TPC8035-H Thickness: 1.6 typ. Unit: mm	SOP Advance Typical product: TPCA8028-H Thickness: 0.95 typ. Unit: mm

4-2 Application Examples and Block Diagrams

Cell Phone (Power Supply Circuit)

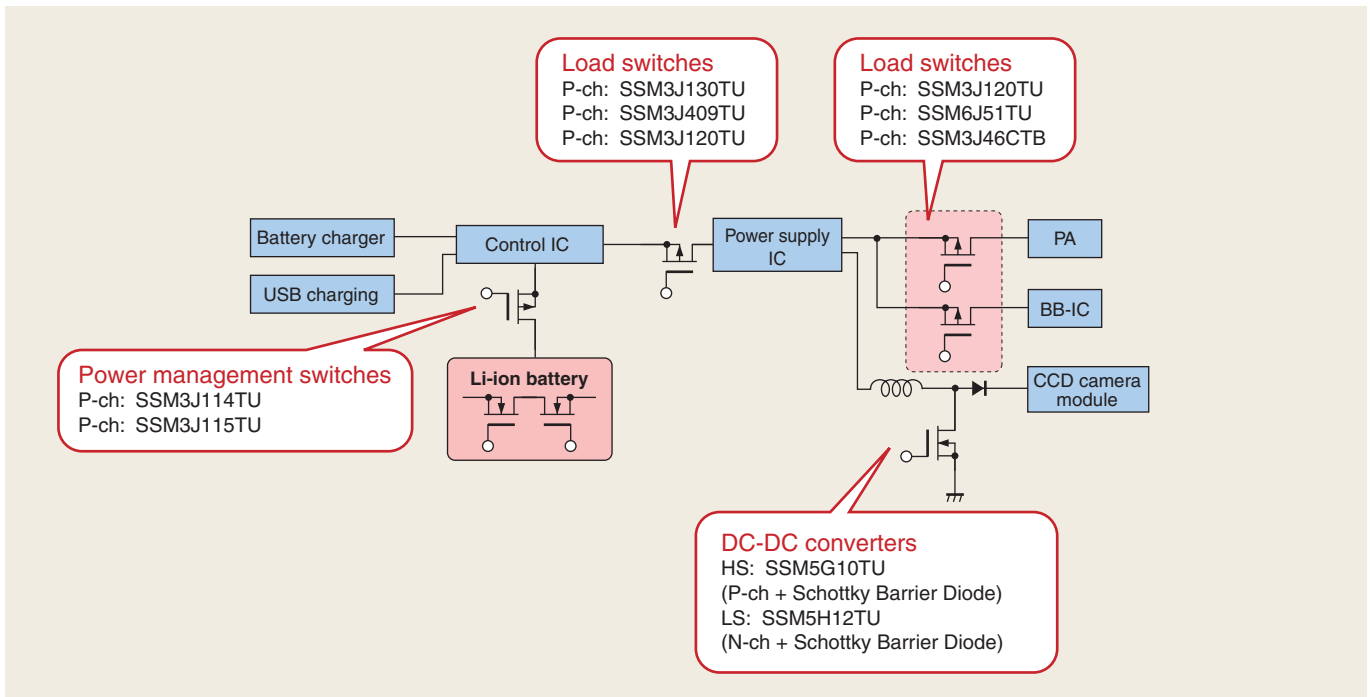

Notebook PC (Power Supply Circuit)

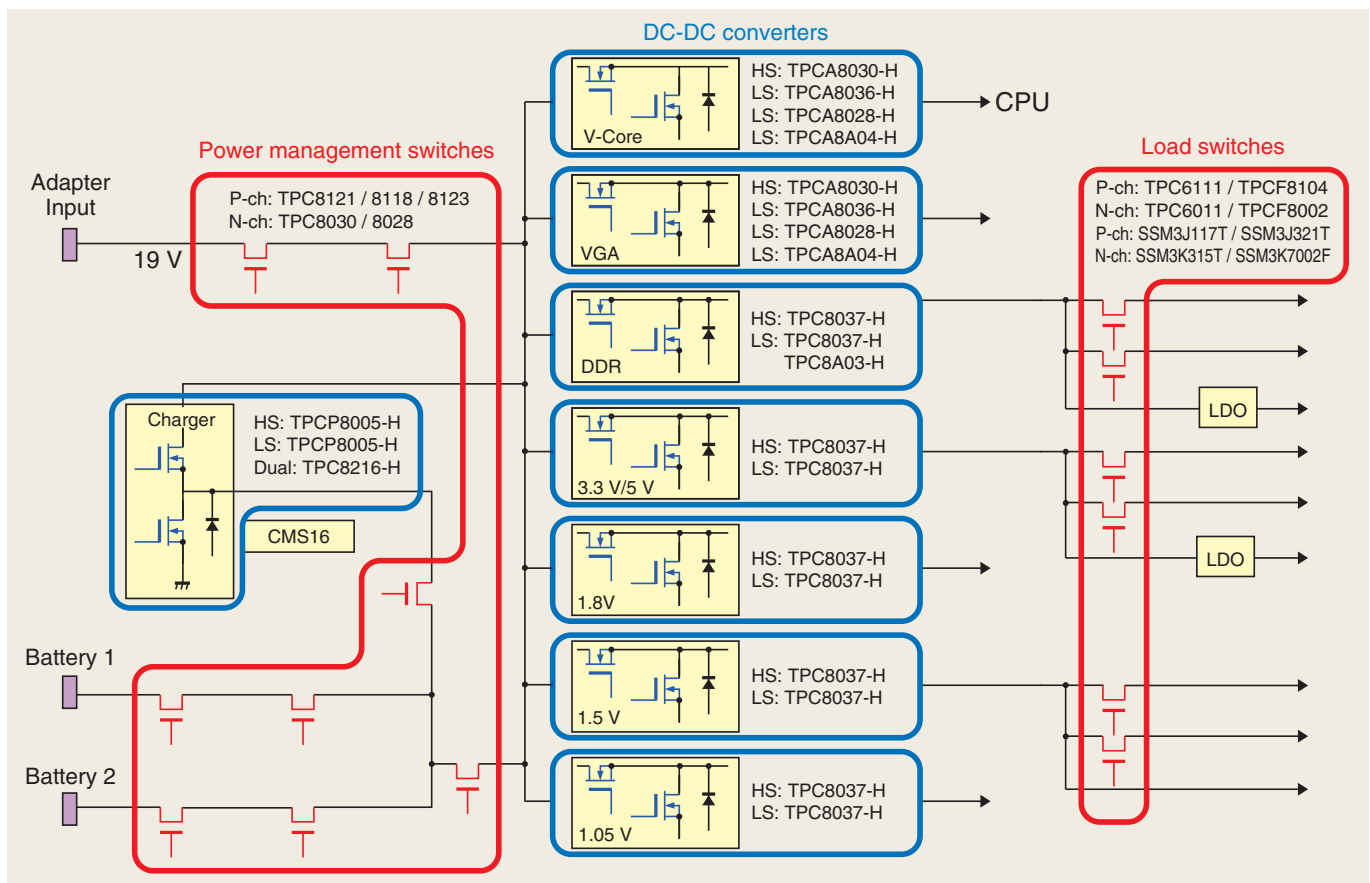

4-2 Application Examples and Block Diagrams

Lithium-Ion Secondary Battery (Battery Protection Circuits)

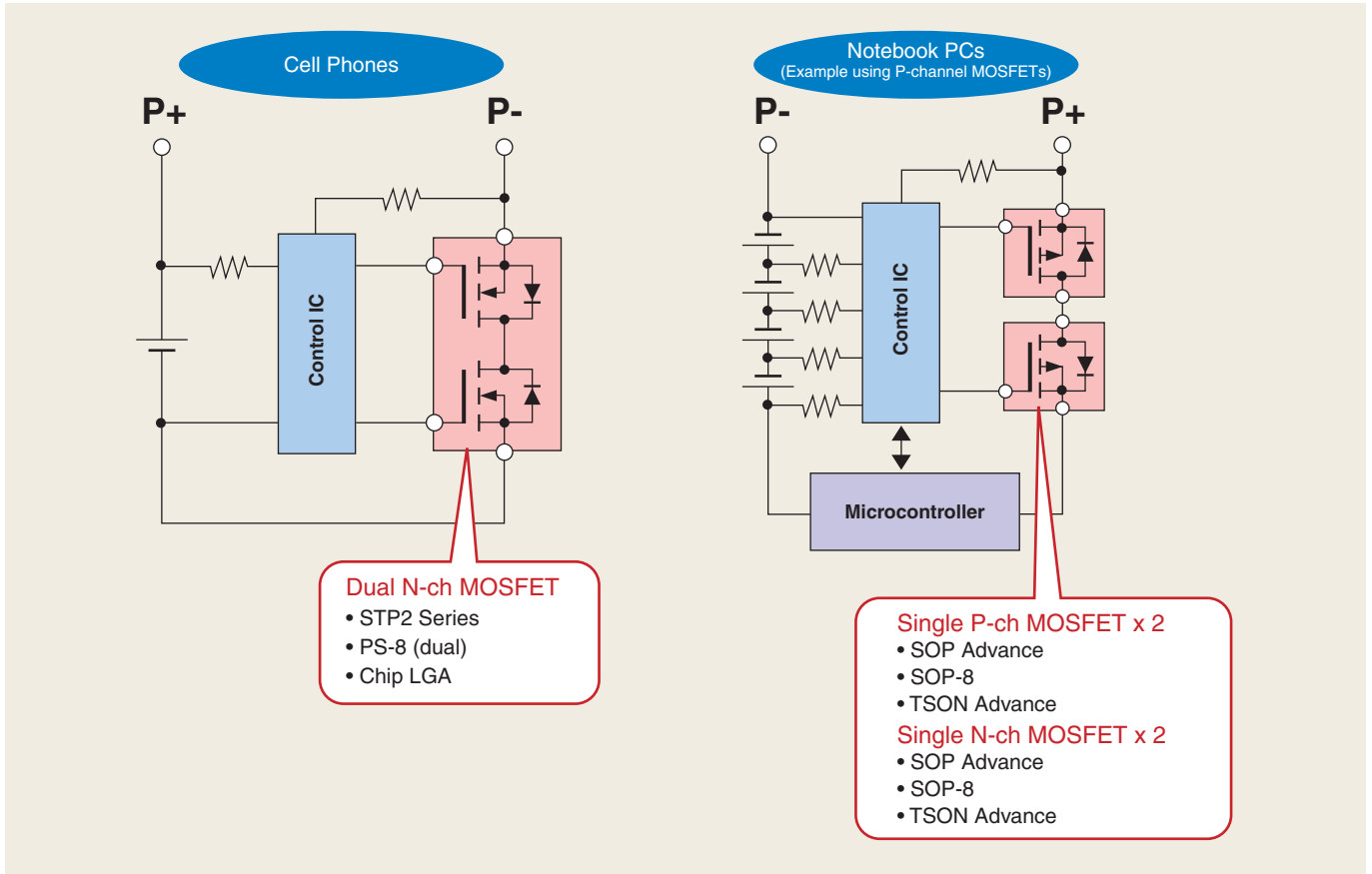

Motor Driver (Power Driver Circuit)

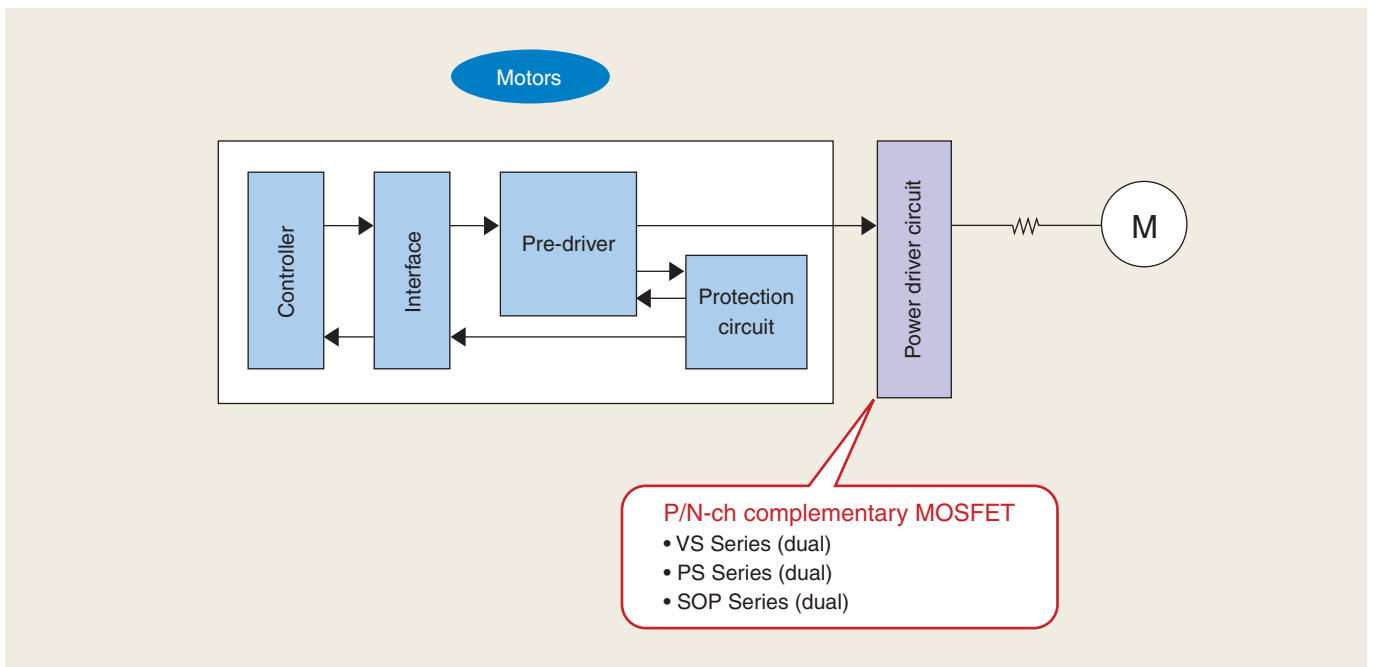

4-3 Low- V_{DSS} MOSFET Roadmaps

Roadmap for Trench MOSFETs

■ High-Speed, Low- V_{DSS} U-MOS

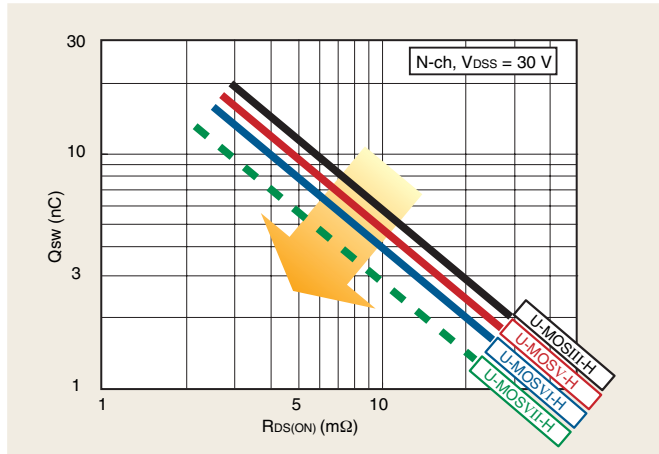

■ Low-Ron Trench MOSFETs

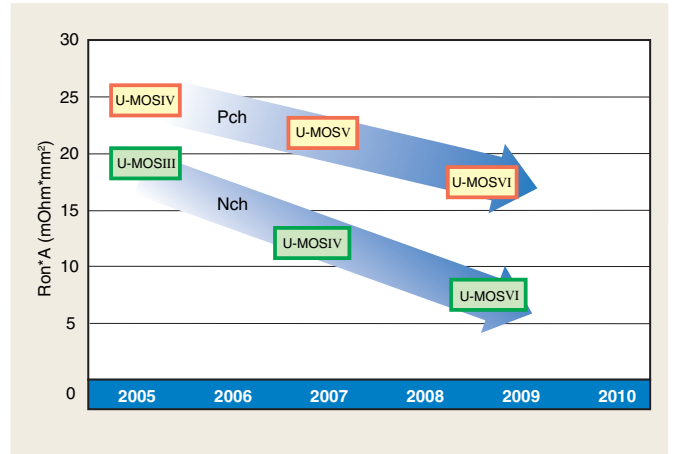

Package Options

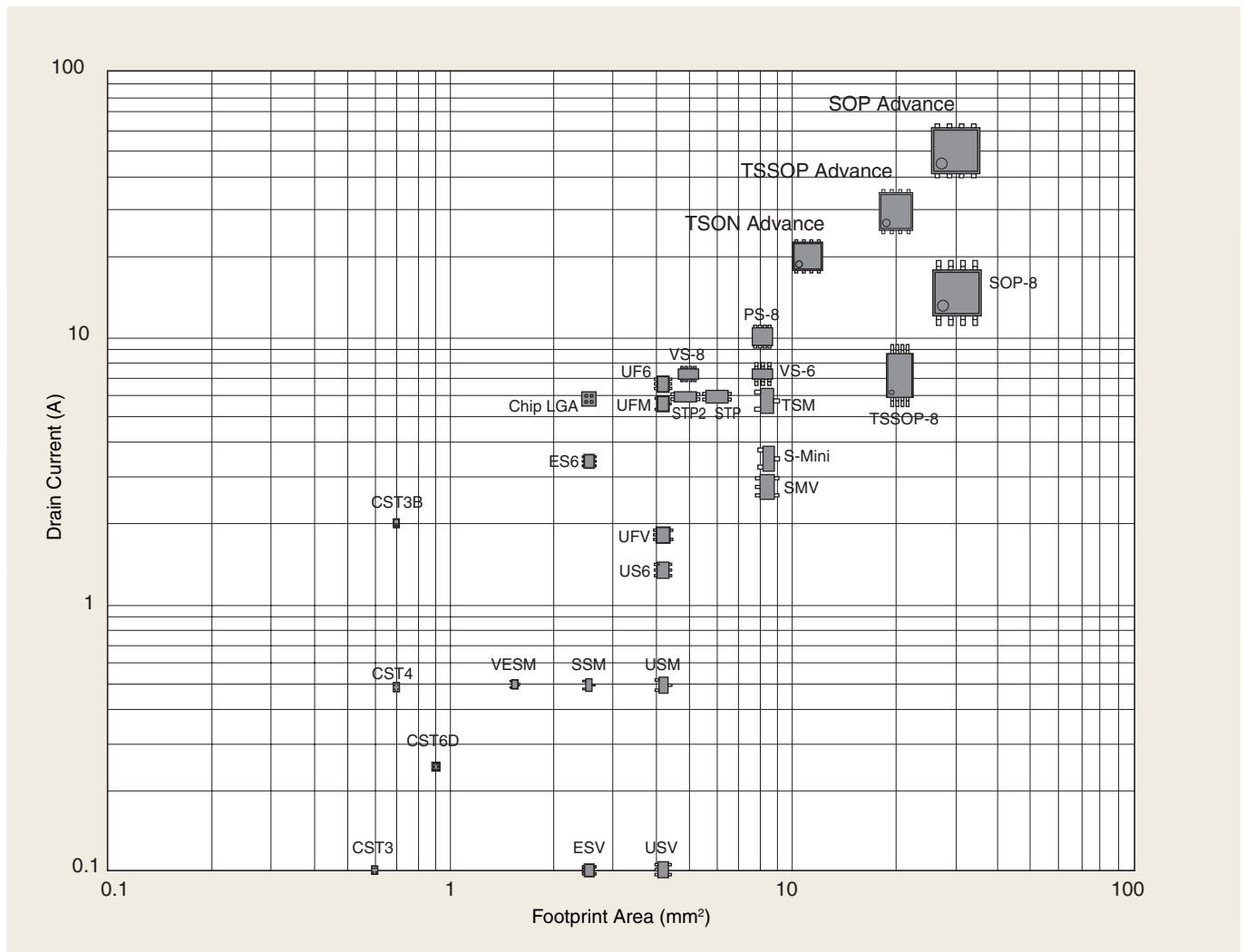

Ultra-Small Packages

	S-Mini	USM	SSM	VESM	CST3	US6	USV	ESV	CST6D
Footprint Area	7.3 mm ²	4.2 mm ²	2.6 mm ²	1.4 mm ²	0.6 mm ²	4.2 mm ²	4.2 mm ²	2.6 mm ²	0.9 mm ²
Permissible Power Dissipation (Note)	0.2 W	0.2 W	0.1 W	0.15 W	0.1 W	0.2 W	0.2 W	0.15 W	0.14 W
Height (MAX)	1.4 mm	1.1 mm	0.9 mm	0.55 mm	0.4 mm	1.1 mm	1.1 mm	0.6 mm	0.4 mm

Note: Mounted on FR4 Board (25.4 x 25.4 mm)

Thermally-Enhanced Compact Packages

	TSM	UF6	SMV	UFV	UFM	ES6	CST3B	CST4
Footprint Area	8.1 mm ²	4.2 mm ²	8.1 mm ²	4.2 mm ²	4.2 mm ²	2.6 mm ²	1.0 mm ²	1.0 mm ²
Permissible Power Dissipation (Note)	0.7 W	0.5 W	0.75 W	0.5 W	0.5 W	0.5 W	1.0 W	0.4 W
Height (MAX)	0.85 mm	0.75 mm	1.4 mm	0.75 mm	0.75 mm	0.6 mm	0.5 mm	0.4 mm

Note: Mounted on FR4 Board (25.4 x 25.4 mm)

Thermally Enhanced Packages

	SOP Adv.	SOP-8	TSSOP Adv.	TSON Adv.
Footprint Area	30 mm ²	30 mm ²	16.3 mm ² (-46%)	10.9 mm ² (-64%)
Permissible Power Dissipation	2.8 W (+47%)	1.9 W	2.3 W (+21%)	1.9 W
Height	1.0 mm (-47%)	1.9 mm	0.8 mm (-58%)	0.9 mm (-53%)

(Percentage relative to SOP-8)

Compact Packages

	VS-8	VS-6	PS-8	Chip LGA
Footprint Area	5.5 mm ² (-32%)	8.1 mm ²	8.1 mm ²	2.56 mm ² (-68%)
Permissible Power Dissipation	2.5 W (+14%)	2.2 W	1.68 W (-24%)	—
Height	0.85 mm	0.85 mm	0.85 mm	0.25 mm (-71%)

(Percentage relative to VS-6)

4-4 Low- V_{DS} , High-Speed MOSFETs

Synchronous Rectification DC-DC Converters – Block Diagram, Timing Chart and Power Loss Factors

Block Diagram



Timing Chart

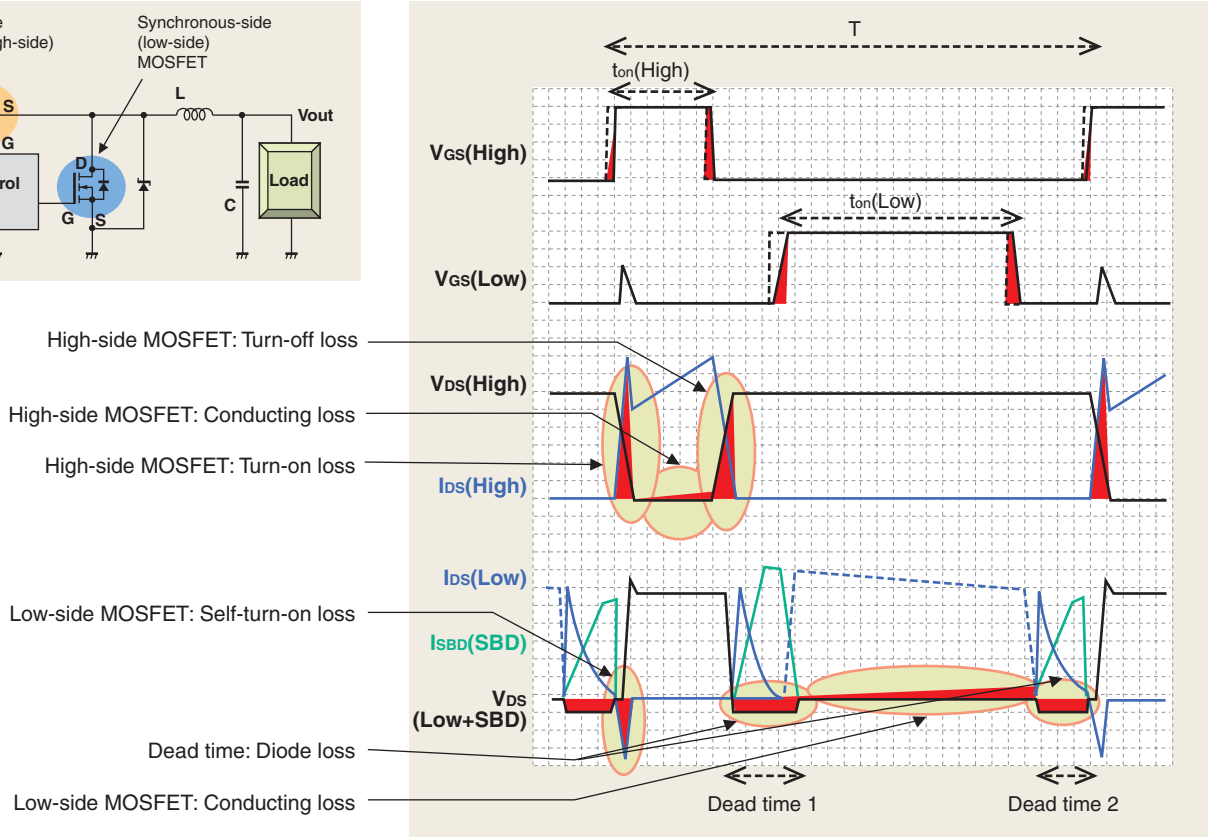

Synchronous Rectification DC-DC Converters – Summary Results of Power Loss Simulation and Key Parameters for MOSFETs

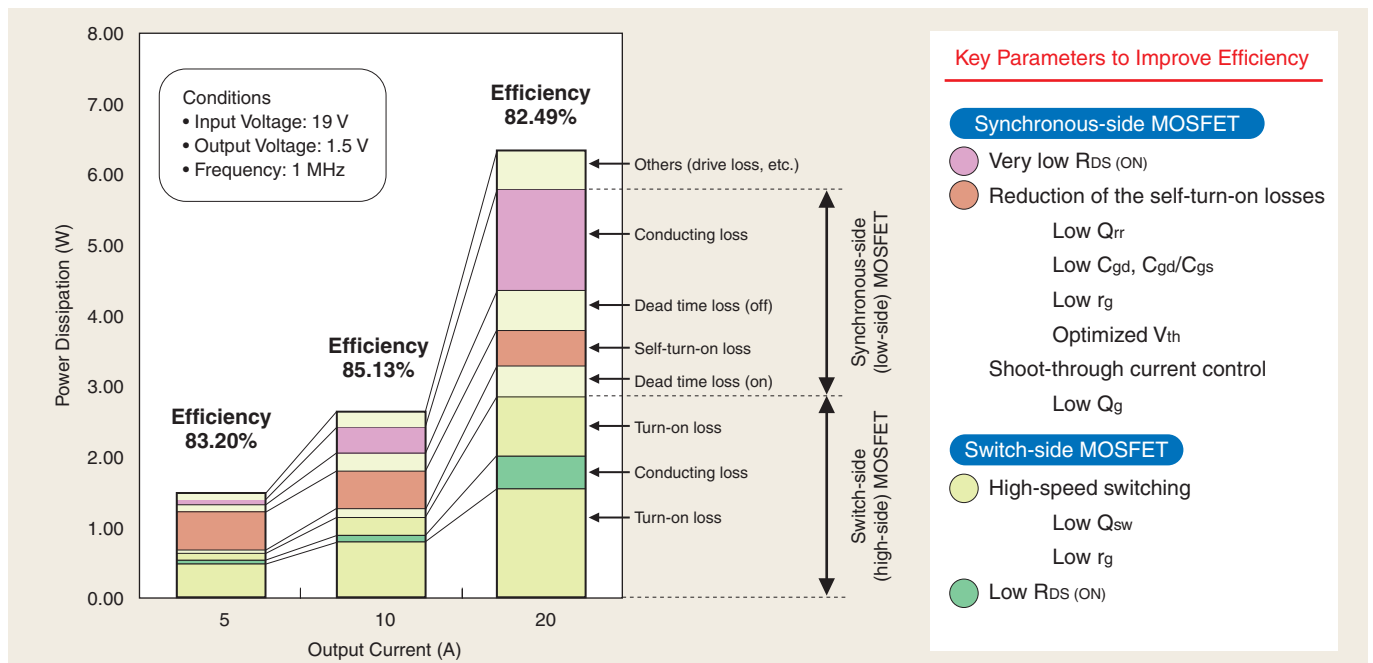

Synchronous Rectification DC-DC Converters – Efficiency Improvement by Thermally Enhanced Package and New Process Technology

Thermally Enhanced Package

Toshiba has developed the SOP Advance package with the same footprint area as the standard SOP-8 package. With an external heatsink on the bottom, the SOP Advance package offers enhanced thermal characteristics, realizing a high power dissipation and thus high-current capability.

Unit: mm

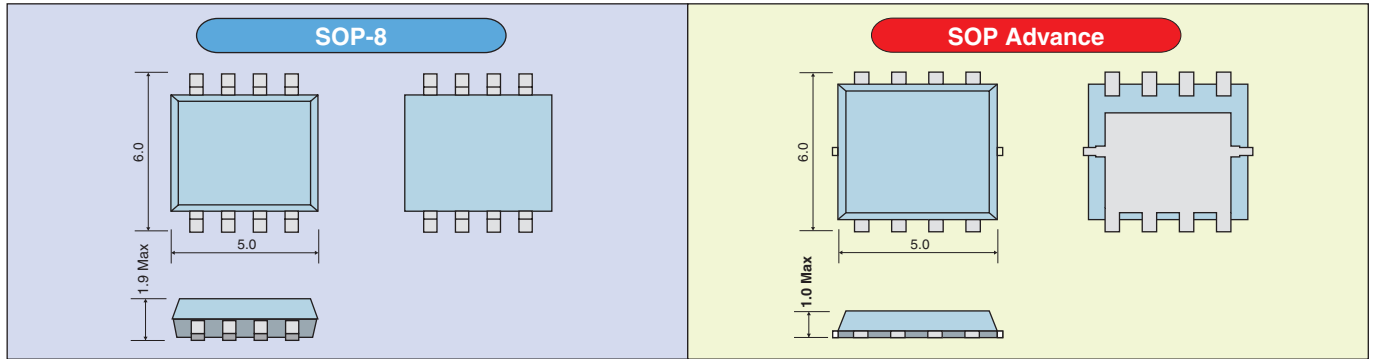

		SOP-8	SOP Advance	Features of the SOP Advance
Footprint Area	(mm ²)	30	30	Same footprint area as the SOP-8
Total height (max)	(mm)	1.9	1.0	Low profile, Thinner by 0.9 mm
R _{th(ch-a)} (t = 10 s) ^(Note 1)	(°C / W)	65.8	44.6	High power dissipation
Current rating	(A)	18	40	High current-carrying capacity
Package resistance ^(Note 2)	(mΩ)	1.6	0.5	Low package resistance

Note 1: When mounted on a glass-epoxy board (25.4 mm x 25.4 mm x 0.8 mm) Note 2: Without chip resistance

New Process Technology

Toshiba has developed a new process technology to further reduce an internal gate resistance (r_g) and gate capacitance ratio (C_{gd}/C_{gs}) for minimizing the self-turn-on loss while maintaining both the low ON-resistance and low gate charge characteristics.

	R _{DS(ON)} Typ. @4.5 V (mΩ)	r_g Typ. (Ω)	C _{gd} /C _{gs} Typ. (%)
TPCA8028-H (New generation)	2.3	1.0	6.8
TPCA8019-H (One gen. ago)	3.1	1.0	6.6
TPCA8004-H (Two gen. ago)	4.8	2.4	12.7

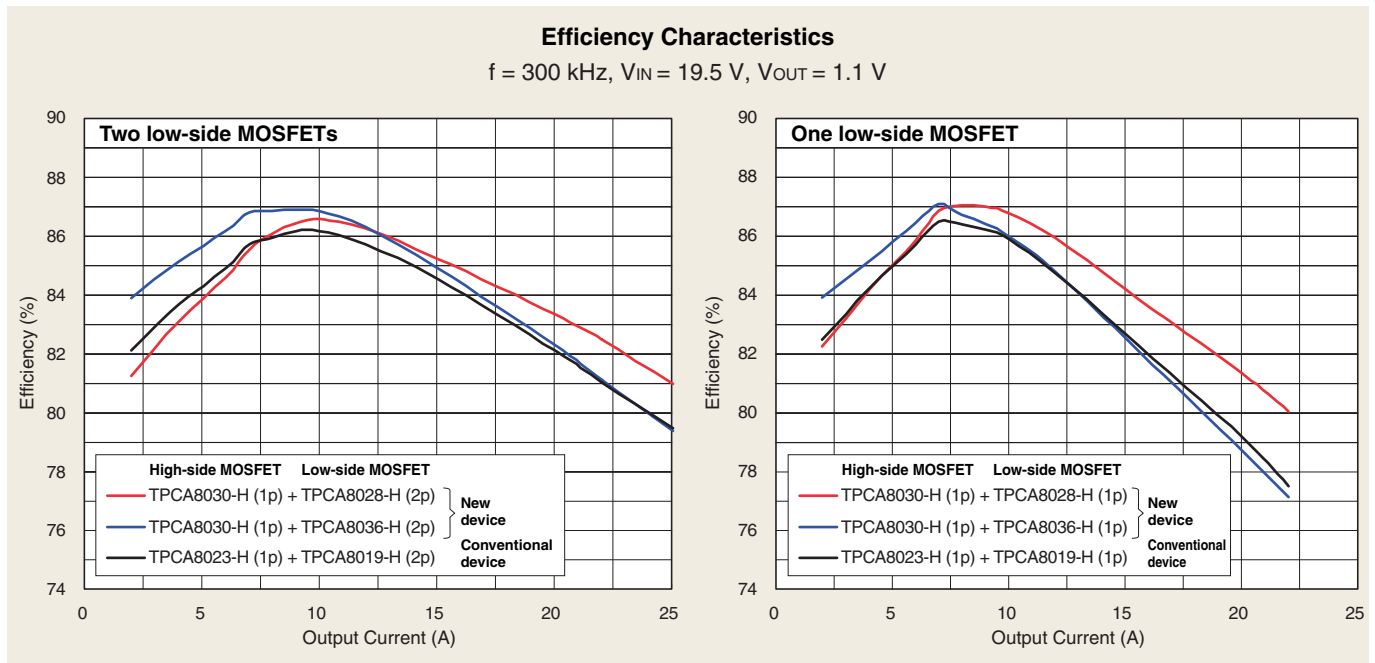

Synchronous Rectification DC-DC Converters – MOSBD (MOSFET with SBD)

External SBD

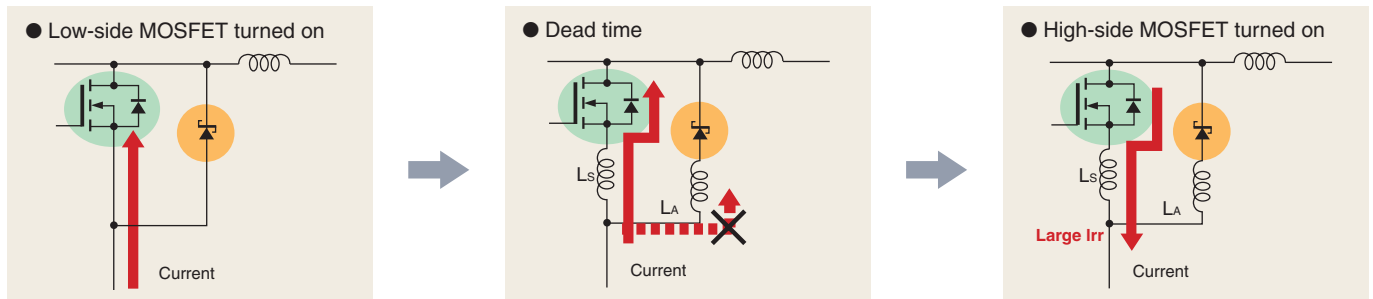

When an SBD is added externally, the SBD can't function fully due to the influence of wire inductances (L_s and L_A); thus a body diode current during the dead time becomes larger and causes the following penalties.

- 1: Increase in the conducting loss of the body diode.
- 2: Increase in the reverse recovery loss due to high di/dt .
- 3: Induces a self-turn-on phenomenon.

MOSFET with SBD (MOSBD)

A MOSFET with SBD using a monolithic structure reduces a wire inductance (L_A) and a parasitic inductance (L_s). This structure makes it possible for the SBD to function fully and to reduce losses.

Current Waveform Simulation

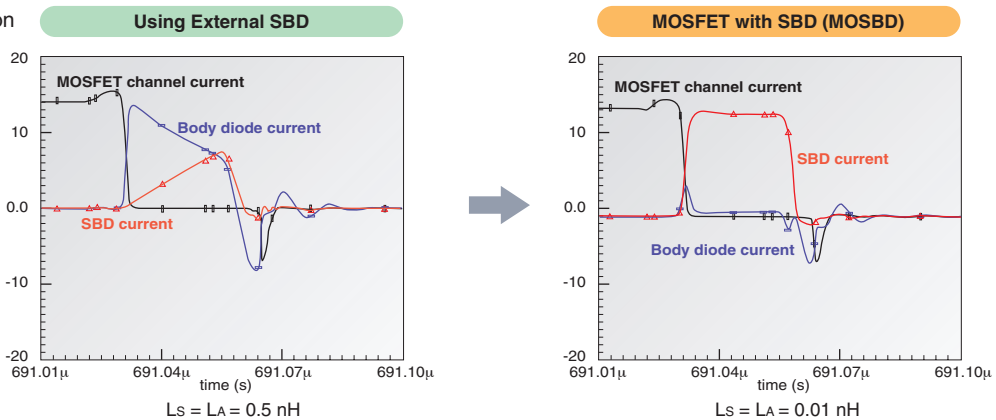

Efficiency Characteristics

$f = 300 \text{ kHz}$, $V_{IN} = 19.5 \text{ V}$, $V_{OUT} = 1.1 \text{ V}$

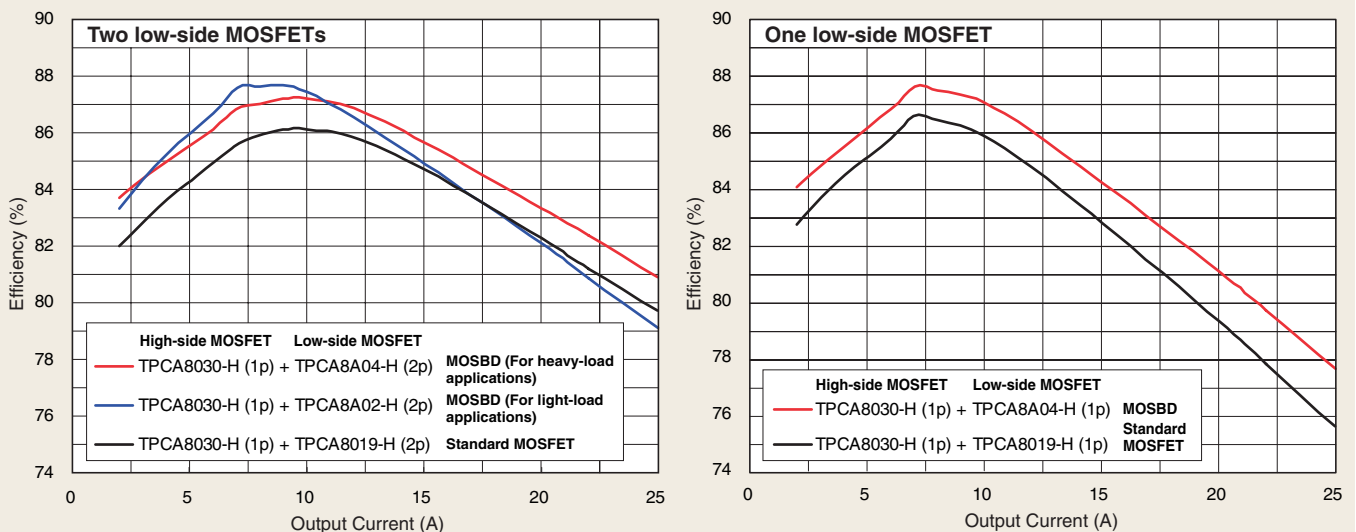

High-Speed MOSFET Offerings

Part Number	Absolute Maximum Ratings			Circuit Configuration	Package	$R_{DS(ON)}$ Max (m Ω)			Qsw Typ.(nC) @ $V_{DS} = V_{DSS} \times 0.8$	Series	
	V_{DSS} (V)	V_{GSS} (V)	I_D (A)			2.5 V	4.5 V	10 V			
TPCA8011-H	20	± 12	40	N-ch Single	SOP Advance	7.5	3.5	—	16	U-MOSIII-H	
TPC6007-H	30		5		VS-6	—	79	54	1.8	U-MOSIII-H	
TPC6109-H	-30		-5	P-ch Single		—	83	59	4.8	U-MOSIII-H	
TPC8216-H ☆			6.4	N-ch Dual	SOP-8	—	23.0	20	3.4	U-MOSVI-H	
TPCP8005-H ☆			11	N-ch Single	PS-8	—	15.7	12.9	5.0	U-MOSV-H	
TPCC8003-H ☆			13		TSON Advance	—	19.3	16.9	4.2	U-MOSVI-H	
TPCC8001-H ☆			22			—	10.6	8.3	7.1	U-MOSV-H	
TPCC8002-H ☆			22			—	10.6	8.3	7.1	U-MOSV-H	
TPCC8006-H ☆			22			—	9.3	8.0	7.4	U-MOSVI-H	
TPCC8005-H ☆			26			—	7.4	6.4	9.1	U-MOSVI-H	
TPCM8003-H ☆			21			TSSOP Advance	—	15.7	12.9	5.0	U-MOSV-H
TPCM8004-H ☆			24		—		13.4	11	5	U-MOSV-H	
TPCM8002-H ☆			30		—		8.2	6.2	9.3	U-MOSV-H	
TPC8021-H			11		SOP-8		—	25	17	3.6	U-MOSIII-H
TPC8031-H ☆			11			—	16.1	13.3	5.0	U-MOSV-H	
TPC8037-H ☆			12			—	13.9	11.4	5	U-MOSV-H	
TPC8038-H ☆			12			—	13.9	11.4	5	U-MOSV-H	
TPC8040-H ☆			13			—	11.1	9.7	5.1	U-MOSVI-H	
TPC8032-H ☆	30		15	—		8.6	6.5	8.4	U-MOSV-H		
TPC8033-H ☆			17	—		7.2	5.3	9.6	U-MOSV-H		
TPC8039-H ☆			17	—		6.9	6.0	8.5	U-MOSVI-H		
TPC8034-H ☆			18	—		4.5	3.5	16	U-MOSV-H		
TPC8036-H ☆			18	—		5.1	4.5	13	U-MOSVI-H		
TPC8035-H ☆			18	—		3.6	3.2	17	U-MOSVI-H		
TPCA8023-H ☆		± 20	21	N-ch Single		SOP Advance	—	15.7	12.9	5.0	U-MOSV-H
TPCA8040-H ☆			23				—	10.8	9.4	5.7	U-MOSVI-H
TPCA8030-H ☆			24				—	13.4	11.0	5	U-MOSV-H
TPCA8031-H ☆			24				—	13.4	11.0	5	U-MOSV-H
TPCA8018-H ☆			30				—	8.2	6.2	9.3	U-MOSV-H
TPCA8039-H ☆			34				—	6.6	5.7	8.6	U-MOSVI-H
TPCA8036-H ☆			38				—	4.8	4.2	13	U-MOSVI-H
TPCA8012-H ☆			40		—		6.8	4.9	11.0	U-MOSV-H	
TPCA8060-H ☆			45		—		3.9	3.4	17	U-MOSVI-H	
TPCA8019-H ☆			45		—		4.1	3.1	15.5	U-MOSV-H	
TPCA8028-H ☆			50		—		3.2	2.8	20	U-MOSVI-H	
TPC6006-H			3.9				VS-6	—	100	75	1.3
TPC8022-H			7.5	N-ch Single	SOP-8	—	35	27	3.5	U-MOSIII-H	
TPC8052-H ☆			12			—	13.3	11.5	6.6	U-MOSVI-H	
TPC8047-H ☆			16			—	8.8	7.6	11	U-MOSVI-H	
TPC8046-H ☆			18			—	6.6	5.7	15	U-MOSVI-H	
TPC8045-H ☆			18			—	4.4	3.9	23	U-MOSVI-H	
TPCA8020-H			7.5			N-ch Single	SOP Advance	—	35	27	3.5
TPCA8052-H ☆	40		20	—	13.1			11.3	6.6	U-MOSVI-H	
TPCA8014-H			30	—	14			9	7.4	U-MOSIII-H	
TPCA8027-H			30	—	—			10	8.1	U-MOSIII-H	
TPCA8047-H ☆			32	—	8.5			7.3	13	U-MOSVI-H	
TPCA8015-H			35	—	7.9			5.4	13	U-MOSIII-H	
TPCA8046-H ☆			38	—	6.3			5.4	15	U-MOSVI-H	
TPCA8045-H ☆			46	—	4.1			3.6	23	U-MOSVI-H	

☆: No protection Zener diode between gate and source

Part Number	Absolute Maximum Ratings			Circuit Configuration	Package	R _{DS(ON)} Max (mΩ)		Q _{sw} Typ. (nC) @ V _{DS} = V _{DS} x 0.8	Series	
	V _{DSS} (V)	V _{GSS} (V)	I _D (A)			4.5 V	10 V			
TPC8218-H ☆	60	±20	3.8	N-ch Dual	SOP-8	64	57	2.6	U-MOSVI-H	
TPC8213-H			5			56	50	2.9	U-MOSIII-H	
TPC8053-H ☆			9	N-ch Single		SOP Advance	24.2	22.5	6.7	U-MOSVI-H
TPC8050-H ☆			11				15.6	14.5	9.2	U-MOSVI-H
TPC8049-H ☆			13				11.5	10.7	13	U-MOSVI-H
TPC8048-H ☆			16				7.4	6.9	17	U-MOSVI-H
TPCA8053-H ☆			15		24		22.3	6.9	U-MOSVI-H	
TPCA8050-H ☆			24		15.3		14.2	10	U-MOSVI-H	
TPCA8016-H			25		26		21	6.6	U-MOSIII-H	
TPCA8049-H ☆			28		11.2		10.4	13	U-MOSVI-H	
TPCA8048-H ☆			35	7.1	6.6	19	U-MOSVI-H			
TPC8051-H ☆			80	13	SOP-8	10.1	9.7	16	U-MOSVI-H	
TPCA8051-H ☆				28	SOP Advance	9.8	9.4	18	U-MOSVI-H	
TPCP8003-H			100	2.2	PS-8	190	180	2.0	U-MOSIII-H	
TPC8214-H	2.2	N-ch Dual		SOP-8	190	180	2.0	U-MOSIII-H		
TPCA8022-H	150	22	SOP Advance	—	26	14	U-MOSIII-H			
TPCA8009-H		7	SOP Advance	—	350	3.7	π-MOSV			
TPCA8010-H		200	5.5	SOP Advance	—	450	3.7	π-MOSV		
TPCA8008-H		250	4	SOP Advance	—	580	3.7	π-MOSV		
TPCP8A05-H ☆		30	8	PS-8	21.9	17.5	2.7	U-MOSV-H		
TPCC8A01-H ☆			21	TSON Advance	12.6	9.9	4.1	U-MOSV-H		
TPCM8A05-H ☆	20		TSSOP Advance	17.2	12.9	3.7	U-MOSV-H			
TPC8A05-H ☆	10		MOSBD	SOP-8	17.6	13.3	3.7	U-MOSV-H		
TPC8A06-H ☆	12				12.9	10.1	4.5	U-MOSV-H		
TPC8A03-H ☆	17				7.0	5.6	8.4	U-MOSV-H		
TPC8A04-H ☆	18				4.5	3.6	13.4	U-MOSV-H		
TPCA8A05-H ☆	20				17.2	12.9	3.7	U-MOSV-H		
TPCA8A02-H ☆	34				SOP Advance	6.7	5.3	8.6	U-MOSV-H	
TPCA8A08-H ☆	38		5.1	3.9		11	U-MOSV-H			
TPCA8A04-H ☆	44	4.1	3.2	13.4		U-MOSV-H				
TPCP8103-H	-40	-4.8	PS-8	54		40	6.5	U-MOSIII-H		
TPC8116-H		-7.5	P-ch Single	SOP-8	37	30	9.7	U-MOSIII-H		
TPCA8107-H		-7.5		SOP Advance	37	30	9.7	U-MOSIII-H		
TPC8406-H	40	6.5	N-ch/P-ch Dual	SOP-8	35	27	3.5	U-MOSIII-H		
	-40	-6.5			37	30	9.7	U-MOSIII-H		

☆: No protection Zener diode between gate and source

4-5 Low- V_{DSS} , Low- $R_{DS(ON)}$ MOSFETs (for Lithium-Ion Battery Protection)

Lithium-Ion Battery Protection Circuit Trend

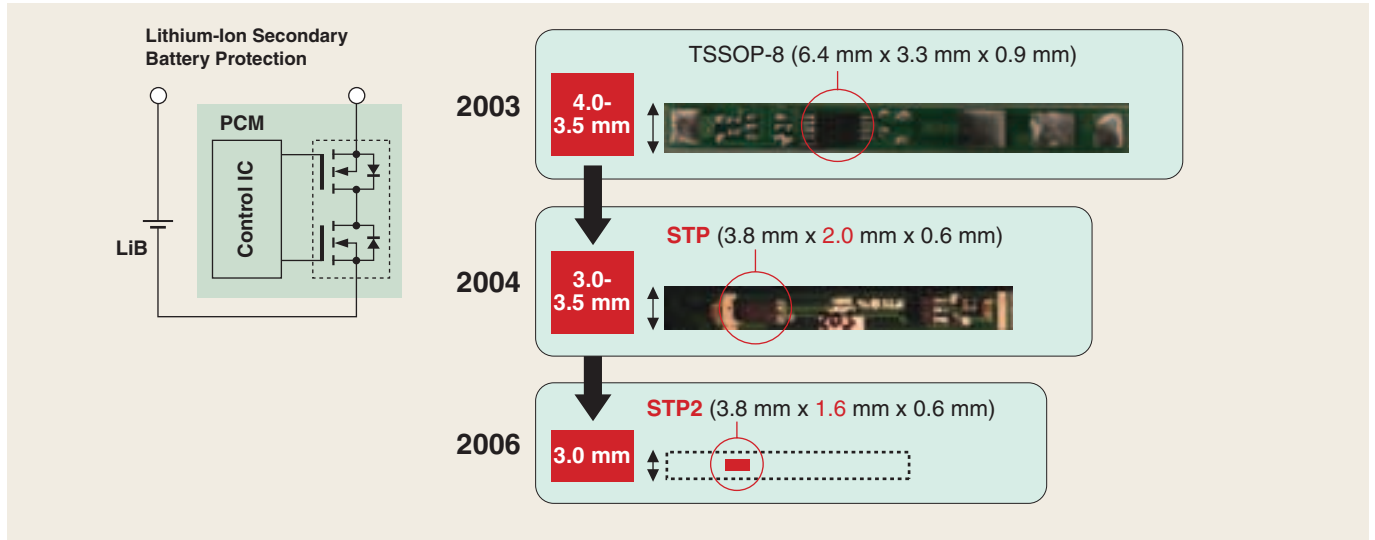

MOSFET Roadmap

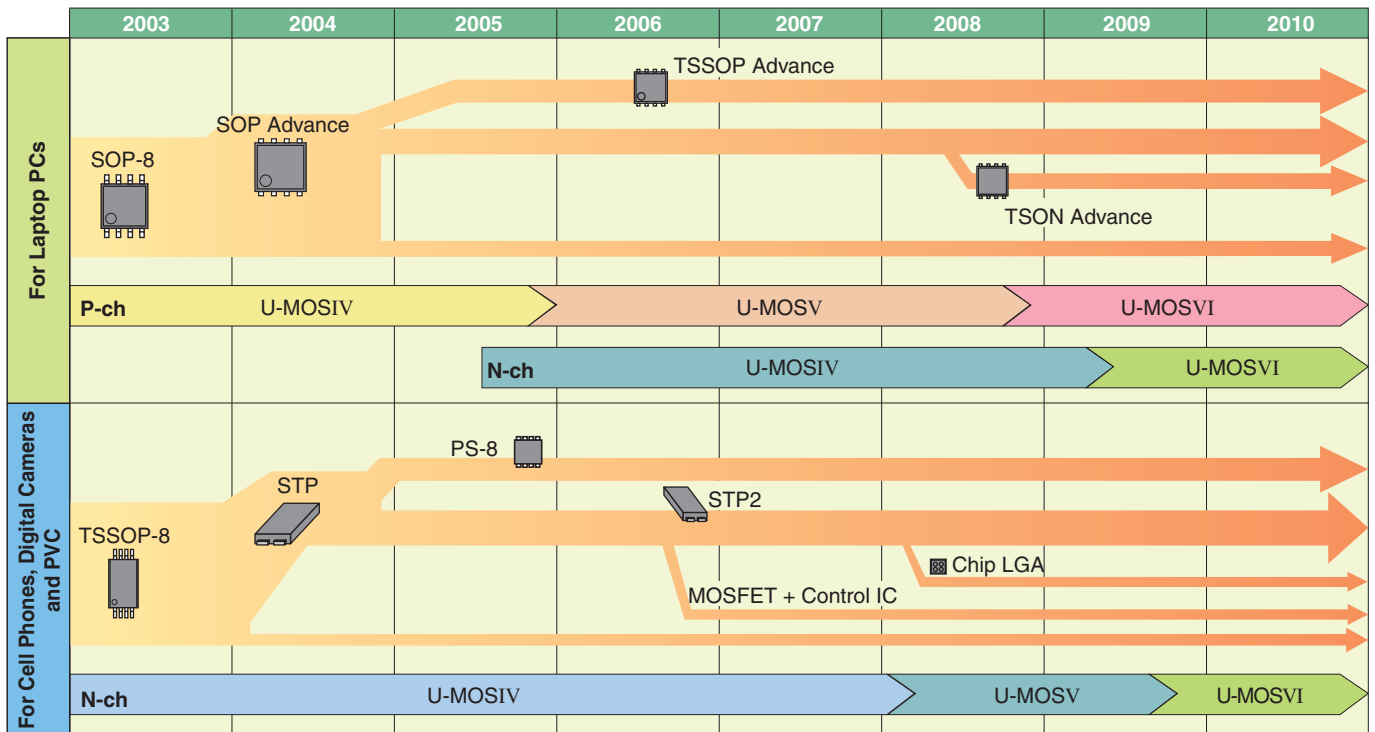

● Low-ON-resistance N-Channel Power MOSFETs

Part Number	Absolute Maximum Ratings			Circuit Configuration	Package	R _{DS(ON)} Max (mΩ)				Series	
	V _{bss} (V)	V _{gss} (V)	I _D (A)			2.5 V	4 V	4.5 V	10 V		
TPCT4203 ☆	20	±12	6	STP2	N-ch Dual	49	32	—	—	U-MOSIV	
TPCT4204 ☆	30	±12	6			52	39	—	—	U-MOSIV	
TPCL4201 ☆	20	±12	6	Chip LGA		52	—	31	—	U-MOSV	
TPCL4203 ☆*	24	±12	6			55	—	36	—	U-MOSV	
TPCL4202 ☆*	30	±12	6	PS-8	N-ch Single	64	—	40	—	U-MOSV	
TPCP8006 ☆	20	±12	9.1			13.7	—	10	—	U-MOSIV	
TPCP8004 ☆	30	±20	8.3	PS-8	N-ch Dual	—	—	14	8.5	U-MOSIV	
TPCP8202	30	±12	5.5			39	24	23	—	U-MOSIV	
TPCC8007 ☆*	20	±12	27	TSON Advance	N-ch Single	(8.7)	—	(4.6)	—	U-MOSIV	
TPCC8008 ☆	30	±25	25			—	—	12.8	6.8	U-MOSIV	
TPC8025 ☆	30	±20	11	—		—	14.5	9	U-MOSIV		
TPC8030 ☆	30	±25	11	—		—	17	9	U-MOSIV		
TPC8041 ☆	30	±20	13	SOP-8	N-ch Single	—	—	13.5	7	U-MOSIV	
TPC8026 ☆	30	±20	13			—	—	10	6.6	U-MOSIV	
TPC8028 ☆	30	±20	18			—	—	8	4.3	U-MOSIV	
TPC8029 ☆	30	±20	18			—	—	7	3.8	U-MOSIV	
TPC8042 ☆	30	±20	18			—	—	6.5	3.4	U-MOSIV	
TPC8027 ☆	30	±20	18			—	—	5.5	2.7	U-MOSIV	
TPC8208	20	±12	5			N-ch Dual	70	50	—	—	U-MOSIII
TPC8207	20	±12	6				30	20	—	—	U-MOSIII
TPC8211	30	±20	5.5				—	—	44	36	U-MOSIII
TPC8210	30	±20	8				—	—	20	15	U-MOSIII
TPCA8024 ☆	30	±20	35	SOP Advance	N-ch Single	—	—	7.8	4.3	U-MOSIV	
TPCA8025 ☆	30	±20	40			—	—	6.0	3.5	U-MOSIV	
TPCA8042 ☆	30	±20	45			—	—	5.7	3.3	U-MOSIV	
TPCA8026 ☆	30	±20	45			—	—	4.5	2.2	U-MOSIV	

☆: No protection Zener diode between gate and source * : Under development

● Low-ON-resistance P-Channel Power MOSFETs

Part Number	Absolute Maximum Ratings			Circuit Configuration	Package	R _{DS(ON)} Max (mΩ)				Series
	V _{bss} (V)	V _{gss} (V)	I _D (A)			2.5 V	4 V	4.5 V	10 V	
TPCC8102 ☆	-30	±20	-15	TSON Advance	P-ch Single	—	33.2	—	18.9	U-MOSV
TPCC8103 ☆	-30	±20	-18			—	22	—	12	U-MOSV
TPC8115	-20	±8	-10	SOP-8		14	—	10	—	U-MOSIV
TPC8119 ☆	-30	±20	-10			—	28	—	13	U-MOSV
TPC8121 ☆	-30	±20	-11			—	24	—	12	U-MOSV
TPC8111	-30	±20	-11			—	18	—	12	U-MOSIV
TPC8113	-30	±20	-11			—	18	—	10	U-MOSIV
TPC8123 ☆	-30	-25/+20	-11			—	—	12.5	9	U-MOSVI
TPC8122 ☆	-30	±20	-12			—	16.5	—	8	U-MOSV
TPC8118 ☆	-30	±20	-13			—	15	—	7	U-MOSV
TPC8114	-30	±20	-18			—	6.8	—	4.5	U-MOSIV
TPC8117 ☆	-30	±20	-18			—	7.9	—	3.9	U-MOSV
TPC8120 ☆	-30	-25/+20	-18	—		—	4.2	3.2	U-MOSVI	
TPC8405	30	±20	6	N-ch/P-ch Dual		—	—	33	26	U-MOSIII
	-30	±20	-4.5			—	—	42	33	U-MOSIV
TPCM8102 ☆	-30	±20	-25	TSSOP Advance		P-ch Single	—	16	—	7.7
TPCA8105	-12	±8	-6	SOP Advance	51		33	—	—	U-MOSIV
TPCA8103	-30	±20	-40		—		6.8	—	4.2	U-MOSIV
TPCA8106 ☆	-30	±20	-40		—		7.8	—	3.7	U-MOSV

☆: No protection Zener diode between gate and source

4-6 Semi-Power MOSFET Offerings

Semi-Power P-Channel Single MOSFETs

Unit: mm

Package	Part Number	V_{DSS} (V)	V_{GS} (V)	I_D (A)	$R_{DS(ON)}$ Max (m Ω)				C_{iss} (pF)	Series	*Internal Connections	Land Pattern Example
					$V_{GS} = 1.5$ V	$V_{GS} = 1.8$ V	$V_{GS} = 2.5$ V	$V_{GS} = 4.0$ V				
CST3B 	SSM3J46CTB	-20	± 8	-2.0	250	178	133	103 (@4.5 V)	290	U-MOSVI		
ES6 (SOT-563) 	SSM6J212FE*	-20	± 8	-3.3	108	73.7	45.6	43.4(@4.5V)	834	U-MOSVI		
	SSM6J53FE	-20	± 8	-1.8	364	204	136	—	568	U-MOSIV		
	SSM6J206FE	-20	± 8	-2.0	—	320	186	130	335	U-MOSIII		
	SSM6J205FE	-20	± 8	-0.8	—	460	306	234	250	U-MOSIII		
	SSM6J26FE	-20	± 8	-0.5	—	980	330	230	250	U-MOSIII		
	SSM6J23FE	-12	± 8	-1.2	—	—	210	160	420	U-MOSIII		
	SSM6J25FE	-20	± 12	-0.5	—	—	430	260	218	U-MOSIII		
SSM6J207FE	-30	± 20	-1.4	—	—	—	491	137	U-MOSII			
UFM 	SSM3J132TU*	-12	± 5	-5.0	40.4	28.3	21.7	17.8(@4.5V)	2700	U-MOSVI		
	SSM3J130TU	-20	± 8	-4.4	63.2	41.1	31	25.8(@4.5V)	1800	U-MOSVI		
	SSM3J120TU	-20	± 8	-4.0	140	78	49	38	1484	U-MOSIV		
	SSM3J129TU	-20	± 8	-4.6	137	88	62	46(@4.5V)	640	U-MOSV		
	SSM3J115TU	-20	± 8	-2.2	353	193	125	98	568	U-MOSIV		
	SSM3J110TU	-12	± 8	-2.3	—	240	145	94	550	U-MOSIII		
	SSM3J109TU	-20	± 8	-2.0	—	300	172	130	335	U-MOSIII		
	SSM3J114TU	-20	± 8	-1.8	526	321	199	149	331	U-MOSIV		
	SSM3J108TU	-20	± 8	-1.8	—	363	230	158	250	U-MOSIII		
	SSM3J113TU	-20	± 12	-1.7	—	—	249	169	370	U-MOSIII		
	SSM3J111TU	-20	± 12	-1.0	—	—	680	480	160	U-MOSIII		
	SSM3J117TU	-30	± 20	-2.0	—	—	—	225	280	U-MOSII		
	SSM3J118TU	-30	± 20	-1.4	—	—	—	480	137	U-MOSII		
SSM3J112TU	-30	± 20	-1.1	—	—	—	790	86	U-MOSII			
UF6 	SSM6J409TU	-20	± 8	-9.5	72.3	46.3	30.2	22.1(@4.5V)	1100	U-MOSV		
	SSM6J51TU	-12	± 8	-4.0	150	85	54	—	1700	U-MOSIV		
	SSM6J50TU	-20	± 10	-2.5	—	205(@2.0V)	100	64(@4.5V)	800	U-MOSIV		
	SSM6J21TU	-12	± 12	-3.0	—	—	88	50	1300	U-MOSIII		
	SSM6J401TU	-30	± 20	-2.5	—	—	—	145	730	U-MOSIII		
SSM6J402TU	-30	± 20	-2.0	—	—	—	225	280	U-MOSIII			
US6(SOT-363) 	SSM6J08FU	-20	± 12	-1.3	—	460(@2.0V)	260	180	370	U-MOSII		
	SSM6J06FU	-20	± 12	-0.65	—	—	700	500	160	π -MOSVI		
	SSM6J07FU	-30	± 20	-0.8	—	—	—	800	130	π -MOSVI		
TSM 	SSM3J307T	-20	± 8	-5.0	83	56	40	31(@4.5V)	1170	U-MOSV		
	SSM3J321T	-20	± 8	-5.2	137	88	62	46(@4.5V)	640	U-MOSV		
	SSM3J326T*	-30	± 12	-5.6	—	115	62.5	45.7(@4.5V)	640	U-MOSVI		
	SSM3J13T	-12	± 8	-3.0	—	180(@2.0V)	95	70	890	U-MOSIII		
	SSM3J312T	-12	± 8	-2.7	—	237	142	91	550	U-MOSIII		
	SSM3J304T	-20	± 8	-2.3	—	297	169	127	335	U-MOSIII		
	SSM3J317T	-20	± 8	-3.6	—	306	144	107(@4.5V)	390	U-MOSIII		
	SSM3J313T	-20	± 8	-1.6	—	640	396	268	170	U-MOSIII		
	SSM3J01T	-30	± 10	-1.7	—	—	600	400	240	π -MOSVI		
	SSM3J02T	-30	± 10	-1.5	—	—	700	500	150	π -MOSVI		
	SSM3J314T	-30	± 20	-3.5	—	—	—	100	505	U-MOSIII-H		
	SSM3J14T	-30	± 20	-2.7	—	—	—	170	413	U-MOSII		
	SSM3J306T	-30	± 20	-2.4	—	—	—	225	280	U-MOSII		
SSM3J305T	-30	± 20	-1.7	—	—	—	477	137	U-MOSII			
S-Mini 	SSM3J327F*	-20	± 8	-3.5	242	170	125	95(@4.5V)	290	U-MOSVI		
	SSM3J325F*	-20	± 8	-2.0	362	252	191	155(@4.5V)	226	U-MOSVI		

*: Under development

* The internal connection diagrams only show the general configurations of the circuits.

Semi-Power N-Channel Single MOSFETs

Unit: mm

Package	Part Number	V _{DSS} (V)	V _{GSS} (V)	I _b (A)	R _{DS(ON)} Max (mΩ)				C _{iss} (pF)	Series	*Internal Connections	Land Pattern Example
					V _{GS} = 1.5 V	V _{GS} = 1.8 V	V _{GS} = 2.5 V	V _{GS} = 4.0 V				
CST4 	SSM4K27CT	20	±12	0.5	—	390	260	205	174	U-MOSIII		
	ES6 (SOT-563) 	SSM6K211FE	20	±10	3.2	118	82	59	47(@4.5 V)	510	U-MOSIII	
SSM6K203FE		20	±10	2.8	153	106	76	61	400	U-MOSIII		
SSM6K202FE		30	±12	2.3	—	145	101	85	270	U-MOSIII		
SSM6K204FE		20	±10	2.0	307	214	164	126	195	U-MOSIII		
SSM6K208FE		30	±12	1.9	—	296	177	133	123	U-MOSIII		
SSM6K25FE		20	±12	0.5	—	395	190	145	268	U-MOSIII		
SSM6K24FE		30	±12	0.5	—	—	180	145	245	U-MOSIII		
SSM6K22FE		20	±12	1.4	—	—	230	170	125	U-MOSIII		
SSM6K210FE		30	±20	1.4	—	—	—	371	57	U-MOSIII		
SSM6K30FE		20	±20	1.2	—	—	—	420	60	π-MOSVII		
SSM6K31FE		20	±20	1.2	—	—	—	540	36	π-MOSVII		
UFM 	SSM3K123TU	20	±10	4.2	66	43	32	28	1010	U-MOSIII		
	SSM3K121TU	20	±10	3.2	140	93	63	48	400	U-MOSIII		
	SSM3K104TU	20	±12	3.0	—	110	74	56	320	U-MOSIII		
	SSM3K119TU	30	±12	2.5	—	134	90	74	270	U-MOSIII		
	SSM3K102TU	20	±12	2.6	—	154	99	71	268	U-MOSIII		
	SSM3K122TU	20	±10	2.0	304	211	161	123	195	U-MOSIII		
	SSM3K101TU	20	±12	2.2	—	230	138	103	125	U-MOSIII		
	SSM3K127TU	30	±12	2.0	—	286	167	123	123	U-MOSIII		
	SSM3K116TU	30	±12	2.2	—	—	135	100	245	U-MOSIII		
	SSM3K131TU	30	±20	6.0	—	—	—	41.5(@4.5 V)	450	U-MOSIV		
	SSM3K124TU	30	±20	2.4	—	—	—	120	180	π-MOSVII		
	SSM3K105TU	30	±20	2.1	—	—	—	200	102	π-MOSVI		
	SSM3K128TU	30	±20	1.5	—	—	—	360	57	U-MOSIII		
	SSM3K107TU	20	±20	1.5	—	—	—	410	60	π-MOSVII		
SSM3K106TU	20	±20	1.2	—	—	—	530	36	π-MOSVII			
UF6 	SSM6K403TU	20	±10	4.2	66	43	32	28	1050	U-MOSIII		
	SSM6K404TU	20	±10	3.0	147	100	70	55	400	U-MOSIII		
	SSM6K405TU	20	±10	2.0	307	214	164	126	195	U-MOSIII		
	SSM6K18TU	20	±12	4.0	—	—	54	40	1100	U-MOSIII		
	SSM6K406TU	30	±20	4.4	—	—	—	38.5(@4.5 V)	490	U-MOSIV		
	SSM6K34TU	30	±20	3.0	—	—	—	77(@4.5 V)	470	U-MOSIII		
	SSM6K407TU	60	±20	2.0	—	—	—	440	150	π-MOSV		
SSM6K32TU	60	±20	2.0	—	—	—	440	140	π-MOSV			
US6 (SOT-363) 	SSM6K08FU	20	±12	1.6	—	210(@2.0 V)	140	105	306	U-MOSII		
	SSM6K06FU	20	±12	1.1	—	—	210	160	125	π-MOSVI		
	SSM6K07FU	30	±20	1.5	—	—	—	220	102	π-MOSVI		
TSM 	SSM3K310T	20	±10	5.0	66	43	32	28	1120	U-MOSIII		
	SSM3K309T	20	±12	4.7	—	47	35	31	1020	U-MOSIII		
	SSM3K301T	20	±12	3.5	—	110	74	56	320	U-MOSIII		
	SSM3K316T	30	±12	4.0	—	131	87	65(@4.5 V)	270	U-MOSIII		
	SSM3K01T	30	±10	3.2	—	—	150	120	152	π-MOSVI		
	SSM3K02T	30	±10	2.5	—	—	250	200	115	π-MOSVI		
	SSM3K315T	30	±20	6.0	—	—	—	41.5(@4.5 V)	450	U-MOSIV		
	SSM3K14T	30	±20	4.0	—	—	—	67	460	U-MOSII		
	SSM3K320T	30	±20	4.2	—	—	—	77(@4.5 V)	190	U-MOSIV		
	SSM3K303T	30	±20	2.9	—	—	—	120	180	π-MOSVII		
	SSM3K12T	30	±20	3.0	—	—	—	175	120	π-MOSVII		
SSM3K318T	60	±20	2.5	—	—	—	145(@4.5 V)	235	U-MOSIV			

* The internal connection diagrams only show the general configurations of the circuits.

4

Low- V_{DSS} MOSFETs (in Small SMD Packages)

Semi-Power Dual MOSFETs

Unit: mm

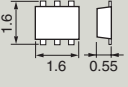
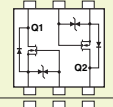
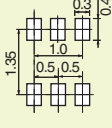
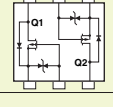
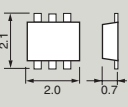
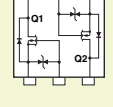
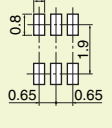
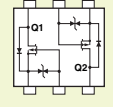
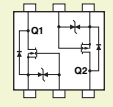
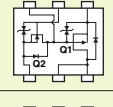
Package	Polarity	Part Number	V_{DSS} (V)	V_{GS} (V)	I_D (A)	$R_{DS(ON)}$ Max (m Ω)				C_{iss} (pF)	Series	*Internal Connections	Land Pattern Example
						$V_{GS} = 1.5V $	$V_{GS} = 1.8V $	$V_{GS} = 2.5V $	$V_{GS} = 4.0V $				
ES6 (SOT-563) 	N-ch x 2	SSM6N42FE*	20	± 10	0.77	630	460	340	260 (@4.5V)	95	U-MOSIII		
	P-ch x 2	SSM6P41FE	-20	± 8	-0.72	1040	670	440	300 (@4.5V)	110	U-MOSV		
UF6 	N-ch x 2	SSM6N39TU	20	± 10	1.6	247	190	139	119	260	U-MOSIII		
		SSM6N29TU	20	± 12	0.8	—	235	178	143	268	U-MOSIII		
		SSM6N25TU	20	± 12	0.5	—	395	190	145	268	U-MOSIII		
		SSM6N24TU	30	± 12	0.5	—	—	180	145	245	U-MOSIII		
		SSM6N40TU	30	± 20	1.6	—	—	—	182	180	U-MOSIII		
	P-ch x 2	SSM6P54TU	-20	± 8	-1.2	555	350	228	—	331	U-MOSIV		
		SSM6P39TU	-20	± 8	-1.5	—	430	294	213	250	U-MOSIII		
		SSM6P28TU	-20	± 8	-0.8	—	460	306	234	250	U-MOSIII		
		SSM6P26TU	-20	± 8	-0.5	—	980	330	230	250	U-MOSIII		
		SSM6P25TU	-20	± 12	-0.5	—	—	430	260	218	U-MOSIII		
	N-ch + P-ch	SSM6L39TU	20	± 10	1.6	247	190	139	119	260	U-MOSIII		
			-20	± 8	-1.5	—	430	294	213	250	U-MOSIII		
		SSM6L13TU	20	± 12	0.8	—	235	178	143	268	U-MOSIII		
		-20	± 8	-0.8	—	460	306	234	250	U-MOSIII			
		SSM6L10TU	20	± 12	0.5	—	395	190	145	268	U-MOSIII		
		-20	± 8	-0.5	—	980	330	230	250	U-MOSIII			
		SSM6L11TU	20	± 12	0.5	—	395	190	145	268	U-MOSIII		
		-20	± 12	-0.5	—	—	430	260	218	U-MOSIII			
	P-ch + N-ch (Load Switch)	SSM6E01TU	-12	± 12	-1.0	—	—	240	160	310	U-MOSIII		
			20	10	0.05	—	—	10 Ω	—	11	π -MOSVI		
		SSM6E02TU	-20	± 8	-1.8	364	204	136	—	568	U-MOSIV		
			20	± 10	0.1	15 Ω	—	4 Ω	3 Ω	9.3	π -MOSVI		
		SSM6E03TU	-20	± 8	-1.8	—	335	180	144	335	U-MOSIII		
			20	± 10	0.1	15 Ω	—	4 Ω	3 Ω	9.3	π -MOSVI		

*: Under development

* The internal connection diagrams only show the general configurations of the circuits.

MOSFET with a Schottky Barrier Diode

Unit: mm

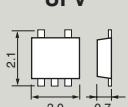
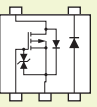
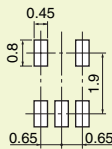
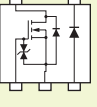
Package	Polarity	Part Number	MOSFET										SBD			*Internal Connections	Land Pattern Example
			V_{DSS} (V)	V_{GS} (V)	I_D (A)	$R_{DS(ON)}$ Max (m Ω)				C_{iss} (pF)	Series	V_R (V)	I_o (A)	V_F Max (V) @ I_F (A)			
						$V_{GS} = 1.5V $	$V_{GS} = 1.8V $	$V_{GS} = 2.5V $	$V_{GS} = 4.0V $								
UFV 	P-ch+ SBD	SSM5G09TU	-12	± 8	-1.5	—	—	200	130	550	U-MOSII	12	0.5	0.43	0.5		
		SSM5G02TU	-12	± 12	-1.0	—	—	240	160	310	U-MOSII	12	0.5	0.43	0.5		
		SSM5G10TU	-20	± 8	-1.5	—	430	294	213	250	U-MOSIII	20	0.7	0.39	0.5		
		SSM5G04TU	-12	± 12	-1.0	—	—	420	240	170	U-MOSII	12	0.5	0.43	0.5		
		SSM5G11TU	-30	± 20	-1.4	—	—	—	403	120	U-MOSIII-H	30	0.7	0.41	0.5		
		SSM5G01TU	-30	± 20	-1.0	—	—	—	800	86	U-MOSII	20	0.5	0.45	0.3		
	N-ch+ SBD	SSM5H10TU	20	± 10	1.6	247	190	139	119	260	U-MOSIII	20	0.7	0.39	0.5		
		SSM5H12TU	30	± 12	1.9	—	296	177	133	123	U-MOSIII	30	0.7	0.41	0.5		
		SSM5H05TU	20	± 12	1.5	—	—	220	160	125	U-MOSIII	12	0.5	0.43	0.5		
		SSM5H08TU	20	± 12	1.5	—	—	220	160	125	U-MOSIII	20	0.5	0.45	0.3		
		SSM5H03TU	12	± 12	1.4	—	—	—	300	125	U-MOSII	12	0.5	0.43	0.5		
		SSM5H11TU	30	± 20	1.6	—	—	—	182	180	U-MOSIII	30	0.7	0.41	0.5		
		SSM5H01TU	30	± 20	1.4	—	—	—	450	106	U-MOSII	20	0.5	0.45	0.3		
SSM5H07TU	20	± 20	1.2	—	—	—	540	36	π -MOSVII	12	0.5	0.43	0.5				

* The internal connection diagrams only show the general configurations of the circuits.

MOSFET with a Schottky Barrier Diode

Unit: mm

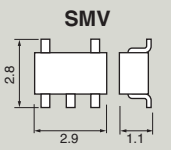
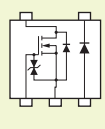
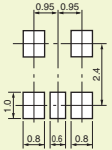
Package	Polarity	Part Number	MOSFET							SBD				*Internal Connections	Land Pattern Example		
			V _{DSS} (V)	V _{GSS} (V)	I _D (A)	R _{DS(ON)} Max (mΩ)				C _{iss} (pF)	Series	V _R (V)	I _O (A)			V _F Max (V)	
						V _{GS} = 1.5V	V _{GS} = 1.8V	V _{GS} = 2.5V	V _{GS} = 4.0V								
	N-ch+ SBD	SSM5H14F	30	±12	3.0	—	138	94	78	270	U-MOSIII	45	0.1	0.6	0.1		

* The internal connection diagrams only show the general configurations of the circuits.

VS-6 Series ... [Part Number: TPC6xxx]

Features

- Zener diode between gate and source for all products
- Thin package, with a board mounting height as low as 0.85 mm (max)

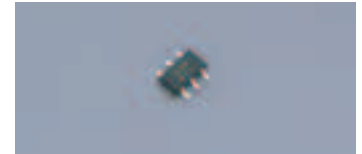

Product Offerings

Part Number	Absolute Maximum Ratings			Circuit Configuration	R _{DS(ON)} Max (mΩ)					Q _g Typ. (nC)	C _{iss} Typ. (pF)	Marking	Series
	V _{DSS} (V)	V _{GSS} (V)	I _D (A)		10 V	4.5 V	2.5 V	2.0 V	1.8 V				
TPC6004	20	±12	6	N-ch Single	—	24	32	37	—	17	1400	S2C	U-MOSIII
TPC6011 ☆*	30	±20	6		20	32	—	—	—	14	640	S2L	U-MOSIV
TPC6005	30	±12	6		—	28	35	41	—	19	1420	S2E	U-MOSIII
TPC6007-H	30	±20	5		54	79	—	—	—	2.8	240	S2G	U-MOSIII-H
TPC6006-H	40	±20	3.9		75	100	—	—	—	2.4	251	S2F	U-MOSIII-H
TPC6103	-12	±8	-5.5	P-ch Single	—	35	55	—	90	20	1520	S3C	U-MOSIII
TPC6105	-20	±8	-2.7		—	110	160	—	300	6	470	S3E	U-MOSIII
TPC6107	-20	±12	-4.5		—	55	100	180	—	9.8	680	S3G	U-MOSIV
TPC6111	-20	±8	-5.5		—	40	57	—	80	10	700	S3L	U-MOSV
TPC6108	-30	±20	-4.5		60	100	—	—	—	13	570	S3H	U-MOSIV
TPC6109-H	-30	±20	-5	59	83	—	—	—	7.2	471	S3J	U-MOSIII-H	

☆: No protection Zener diode between gate and source * : Under development

VS-8 Series ... [Part Number: TPCF8xxx]

Features

- Ultra-low ON-resistance achieved by employing the U-MOS process
- Thin package, with a board mounting height as low as 0.85 mm (max)
- 32% reduction in mounting area compared with the VS-6 (TSOP-6) Series, due to the use of a high-density flat package
- P_D = 2.5 W @ t = 5 s when the device is mounted on a glass epoxy board



Product Offerings

Part Number	Absolute Maximum Ratings			Circuit Configuration	R _{DS(ON)} Max (mΩ)					Q _g Typ. (nC)	C _{iss} Typ. (pF)	Marking	Series
	V _{DSS} (V)	V _{GSS} (V)	I _D (A)		10 V	4.5 V	2.5 V	2.0 V	1.8 V				
TPCF8002 ☆	30	±20	6	N-ch Single	23	31	—	—	—	TBD	TBD	F2B	U-MOSIV
TPCF8101	-12	±8	-6	P-ch Single	—	28	40	—	85	18	1600	F3A	U-MOSIII
TPCF8103	-20	±8	-2.7		—	110	160	—	300	6	470	F3C	U-MOSIII
TPCF8102	-20	±8	-6		—	30	41	—	90	19	1550	F3B	U-MOSIII
TPCF8104	-30	±20	-6		28	38	—	—	—	34	1760	F3D	U-MOSIV
TPCF8201	20	±12	3	N-ch Dual	—	49	66	100	—	7.5	590	F4A	U-MOSIII
TPCF8301	-20	±8	-2.7	P-ch Dual	—	110	160	—	300	6	470	F5A	U-MOSIII
TPCF8302	-20	±10	-3		—	59	95	200	—	11	800	F5B	U-MOSIV
TPCF8303	-20	±8	-3		—	58	87	—	250	11	860	F5C	U-MOSIV
TPCF8304	-30	±20	-3.2		72	105	—	—	—	14	600	F5D	U-MOSIV
TPCF8402	30	±20	4	N-ch + P-ch	50	77	—	—	—	10	470	F6B	U-MOSIII
	-30	±20	-3.2		72	105	—	—	—	14	600		U-MOSIV
TPCF8A01	20	±12	3.0	N-ch + SBD	—	49	66	100	—	7.5	590	F7A	U-MOSIII
TPCF8B01	-20	±8	-2.7	P-ch + SBD	—	110	160	—	300	6	470	F8A	U-MOSIII

☆: No protection Zener diode between gate and source

● PS-8 Series ... [Part Number: TPCP8xxx]

■ Features

- Same mounting area as for the VS-6 (TSOP-6) Series
- Using flat leads and the latest U-MOS process (U-MOSIV), the PS-8 Series offers a 70% reduction in $R_{DS(ON)}$ compared with the VS-6 Series.

■ Product Offerings

Part Number	Absolute Maximum Ratings			Circuit Configuration	$R_{DS(ON)}$ Max (m Ω)					Q_g Typ. (nC)	C_{iss} Typ. (pF)	Series
	V_{DSS} (V)	V_{GSS} (V)	I_D (A)		10 V	4.5 V	4 V	2.5 V	1.8 V			
TPCP8006 ☆	20	± 12	9.1	N-ch Single	—	10	—	13.7	—	22	1480	U-MOSIV
TPCP8001-H	30	± 20	7.2		16	25	—	—	—	11	640	U-MOSIII-H
TPCP8004 ☆	30	± 20	8.3		8.5	14.5	—	—	—	26	1270	U-MOSIV
TPCP8005-H ☆	30	± 20	11		12.9	15.7	—	—	—	20	1433	U-MOSV-H
TPCP8A05-H ☆	30	± 20	8	MOSBD	17.5	21.9	—	—	—	16	1300	U-MOSV-H
TPCP8003-H ☆	100	± 20	2.2	N-ch Single	180	190	—	—	—	7.5	360	U-MOSIII-H
TPCP8101	-20	± 8	-5.6	P-ch Single	—	30	—	41	90	19	1550	U-MOSIII
TPCP8102	-20	± 12	-7.2		—	18	—	30	—	33	2560	U-MOSIV
TPCP8103-H	-40	± 20	-4.8		40	54	—	—	—	19	800	U-MOSIII-H
TPCP8201	30	± 20	4.2	N-ch Dual	50	77	—	—	—	10	470	U-MOSIII
TPCP8202	30	± 12	5.5		—	23	—	39	—	28	2150	U-MOSIV
TPCP8203	40	± 20	4.7	P-ch Dual	40	60	—	—	—	16	770	U-MOSIII
TPCP8301	-20	± 12	-5		—	31	—	60	—	20	1500	U-MOSIV
TPCP8302	-20	± 12	-5		—	—	33	45	95	20	1500	U-MOSIV
TPCP8303	-20	± 8	-3.8		—	40	—	57	—	10	640	U-MOSV
TPCP8401	20	± 10	0.1		N-ch/P-ch Load Switch	—	—	3 Ω	4 Ω	—	—	—
TPCP8402	30	± 20	4.2	N-ch + P-ch	50	77	—	—	—	10	470	U-MOSIII
	-30	± 20	-3.4		72	105	—	—	—	14	600	U-MOSIV
TPCP8404 ☆	30	± 20	4	N-ch + P-ch	50	100	—	—	—	4.6	190	U-MOSIV
	-30	± 20	-4		50	100	—	—	—	13	510	U-MOSV
TPCP8403	40	± 20	4.7	N-ch + P-ch	40	60	—	—	—	16	770	U-MOSIII
	-40	± 20	-3.4		70	105	—	—	—	15	680	U-MOSIII
TPCP8BA1	-20	± 12	-1.3	MOSBD	—	—	180	260	—	—	—	U-MOSII
TPCP8AA1	20	± 12	1.6	—	—	105	140	—	—	—	—	U-MOSII
TPCP8J01	-32	± 20	-5.5	P-ch + NPN	35	—	49	—	—	34	1760	U-MOSIV
	50	—	0.1		—	—	—	—	—	—	—	—

☆: No protection Zener diode between gate and source

● Chip LGA Series ... [Part Number: TPCL4xxx]

■ Features

- Chip-scale package for high-density board assembly (58% reduction in mounting area compared with the STP2 package)

■ Product Offerings

Part Number	Absolute Maximum Ratings			Circuit Configuration	$R_{DS(ON)}$ Max (m Ω)				Q_g Typ. (nC)	C_{iss} Typ. (pF)	Series
	V_{DSS} (V)	V_{GSS} (V)	I_D (A)		4.5 V	4 V	3.1 V	2.5 V			
TPCL4201 ☆	20	± 12	6	N-ch Dual	31	33	44	52	11.5	720	U-MOSV
TPCL4203 ☆*	24	± 12	6		(36)	(38)	(46)	(55)	(10)	(685)	U-MOSV
TPCL4202 ☆*	30	± 12	6		(40)	(42)	(50)	(64)	(10)	(780)	U-MOSV

☆: No protection Zener diode between gate and source * : Under development

● STP2 Series ... [Part Number: TPCT4xxx]

■ Features

- The combination of a new chip design using Toshiba U-MOSIV process technology and a new small pump-structured package, offers low ON-resistance.

■ Product Offerings

Part Number	Absolute Maximum Ratings			Circuit Configuration	$R_{SS(ON)}$ Max (m Ω)			Q_g Typ. (nC)	C_{iss} Typ. (pF)	Series
	V_{SS} (V)	V_{GSS} (V)	I_S (A)		2.5 V	4 V	4.5 V			
TPCT4203	20	± 12	6	N-ch Dual	49	32	31	11	790	U-MOSIV
TPCT4204	30	± 12	6		52	39	38	12	780	U-MOSIV

● TSON Advance Series ... [Part Number: TPCC8xxx]

■ Features

- The small thermally enhanced package gives a 64% reduction in mounting area compared with SOP-8, yet an equivalent maximum permissible power dissipation.

■ Product Offerings

Part Number	Absolute Maximum Ratings			Circuit Configuration	R _{DS(ON)} Max (mΩ)				Q _g Typ. (nC)	C _{iss} Typ. (pF)	Series
	V _{DSS} (V)	V _{GSS} (V)	I _D (A)		10 V	4.5 V	4 V	2.5 V			
TPCC8007 ☆*	20	±12	27	N-ch Single	—	(4.6)	—	(8.7)	TBD	TBD	U-MOSIV
TPCC8008 ☆	30	±25	25		6.8	12.8	—	—	30	1600	U-MOSIV
TPCC8003-H ☆	30	±20	13		16.9	19.3	—	—	8.6	990	U-MOSVI-H
TPCC8001-H ☆	30	±20	22		8.3	10.6	—	—	14.3	1900	U-MOSV-H
TPCC8002-H ☆	30	±20	22		8.3	10.6	—	—	14.3	1900	U-MOSV-H, rg=3.2Ω(Typ.)
TPCC8A01-H ☆	30	±20	21	MOSBD	9.9	12.6	—	—	10.1	1430	U-MOSV-H
TPCC8006-H ☆	30	±20	22	N-ch Single	8.0	9.3	—	—	15.0	1700	U-MOSVI-H
TPCC8005-H ☆	30	±20	26		6.4	7.4	—	—	19.0	2200	U-MOSVI-H
TPCC8102 ☆	-30	±20	-15	P-ch Single	18.9	—	33.2	—	26	1200	U-MOSV
TPCC8103 ☆	-30	±20	-18		12	—	22	—	38	1600	U-MOSV

☆: No protection Zener diode between gate and source * : Under development

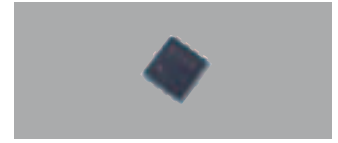

● TSSOP Advance Series ... [Part Number: TPCM8xxx]

■ Product Offerings

Part Number	Absolute Maximum Ratings			Circuit Configuration	R _{DS(ON)} Max (mΩ)			Q _g Typ. (nC)	C _{iss} Typ. (pF)	Series
	V _{DSS} (V)	V _{GSS} (V)	I _D (A)		10 V	4.5 V	4 V			
TPCM8001-H	30	±20	20	N-ch Single	9.5	14	—	19	1130	U-MOSIII-H
TPCM8003-H ☆	30	±20	21		12.9	15.7	—	11	1433	U-MOSV-H
TPCM8004-H ☆	30	±20	24		11	13.4	—	11	1433	U-MOSV-H
TPCM8006	30	±20	25		7.0	13.5	—	26	1270	U-MOSIV
TPCM8002-H ☆	30	±20	30		6.2	8.2	—	18	2270	U-MOSV-H
TPCM8A05-H ☆	30	±20	20	MOSBD	12.9	17.2	—	7.4	1300	U-MOSV-H
TPCM8102	-30	±20	-25	P-ch Single	7.7	—	16	60	2450	U-MOSV

☆: No protection Zener diode between gate and source

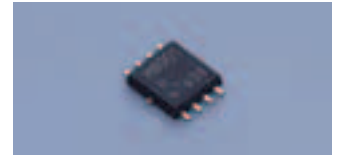

● SOP-8 Series ... [Part Number: TPC8xxx]

■ Features

- Low ON-resistance and high-speed-switching series are available.
Low ON-resistance series: U-MOSIV/V/VI
High-speed-switching series: U-MOSIII-H and U-MOSV-H
- ON-resistance reduction through the use of an Al strap structure

■ Product Offerings

Part Number	Absolute Maximum Ratings			Circuit Configuration	R _{DS(ON)} Max (mΩ)				Q _g Typ. (nC)	C _{iss} Typ. (pF)	Series
	V _{DSS} (V)	V _{GSS} (V)	I _D (A)		10 V	4.5 V	4 V	2.5 V			
TPC8021-H	30	±20	11	N-ch Single	17	25	—	—	11	640	U-MOSIII-H
TPC8025 ☆	30	±20	11		9	14.5	—	—	26	1270	U-MOSIV
TPC8030 ☆	30	±25	11		8.5	17	—	—	24	1140	U-MOSIV
TPC8037-H ☆	30	±20	12		11.4	13.9	—	—	11	1433	U-MOSV-H
TPC8038-H ☆	30	±20	12		11.4	13.9	—	—	11	1433	U-MOSV-H
TPC8040-H ☆	30	±20	13		9.7	11.1	—	—	12	1700	U-MOSVI-H
TPC8041 ☆	30	±20	13		7	13.5	—	—	27	1270	U-MOSIV
TPC8026 ☆	30	±20	13		6.6	10	—	—	42	1800	U-MOSIV
TPC8032-H ☆	30	±20	15		6.5	8.6	—	—	17	2270	U-MOSV-H
TPC8039-H ☆	30	±20	17		5.7	6.6	—	—	18	2600	U-MOSVI-H
TPC8033-H ☆	30	±20	17		5.3	7.2	—	—	22	2900	U-MOSV-H

☆: No protection Zener diode between gate and source



■ Product Offerings

Part Number	Absolute Maximum Ratings			Circuit Configuration	$R_{DS(ON)}$ Max ($m\Omega$)				Q_g Typ. (nC)	C_{iss} Typ. (pF)	Series
	V_{DSS} (V)	V_{GS} (V)	I_D (A)		10 V	4.5 V	4 V	2.5 V			
TPC8028 ☆	30	±20	18	N-ch Single	4.3	8	—	—	45	1800	U-MOSIV
TPC8029 ☆	30	±20	18		3.8	7	—	—	49	2200	U-MOSIV
TPC8036-H ☆	30	±20	18		4.5	5.1	—	—	26	3500	U-MOSVI-H
TPC8034-H ☆	30	±20	18		3.5	4.5	—	—	35	4614	U-MOSV-H
TPC8035-H ☆	30	±20	18		3.2	3.6	—	—	44	6000	U-MOSVI-H
TPC8042 ☆	30	±20	18		3.4	6.5	—	—	56	2900	U-MOSIV
TPC8027 ☆	30	±20	18		2.7	5.5	—	—	113	4200	U-MOSIV
TPC8022-H	40	±20	7.5		27	35	—	—	11	650	U-MOSIII-H
TPC8052-H ☆	40	±20	12		11.5	13.3	—	—	13	1620	U-MOSVI-H
TPC8047-H ☆	40	±20	16		7.6	8.8	—	—	23	2590	U-MOSVI-H
TPC8046-H ☆	40	±20	18		5.7	6.6	—	—	31	3545	U-MOSVI-H
TPC8045-H ☆	40	±20	18		3.9	4.4	—	—	48	5800	U-MOSVI-H
TPC8053-H ☆	60	±20	9		22.5	24.2	—	—	13	1620	U-MOSVI-H
TPC8050-H ☆	60	±20	11		14.5	15.6	—	—	21	2590	U-MOSVI-H
TPC8049-H ☆	60	±20	13		10.7	11.5	—	—	29	3545	U-MOSVI-H
TPC8048-H ☆	60	±20	16		6.9	7.4	—	—	46	5800	U-MOSVI-H
TPC8051-H ☆	80	±20	13		9.7	10.1	—	—	43	5800	U-MOSVI-H
TPC8012-H	200	±20	1.8		400	—	—	—	11	440	π -MOSV
TPC8208	20	±12	5	N-ch Dual	—	—	50	70	9.5	780	U-MOSIII
TPC8207	20	±12	6		—	—	20	30	22	2010	U-MOSIII
TPC8211	30	±20	5.5		36	44	—	—	25	1250	U-MOSIII
TPC8212-H	30	±20	6		21	27	—	—	16	840	U-MOSIII-H
TPC8216-H ☆	30	±20	6.4		20	23	—	—	7.6	900	U-MOSVI-H
TPC8210	30	±20	8		15	20	—	—	75	3530	U-MOSIII
TPC8218-H ☆	60	±20	3.8		57	64	—	—	5.7	640	U-MOSVI-H
TPC8213-H	60	±20	5		50	56	—	—	6	625	U-MOSIII-H
TPC8214-H	100	±20	2.2	180	190	—	—	4.5	360	U-MOSIII-H	
TPC8115	-20	±8	-10	P-ch Single	—	10	—	14	115	9130	U-MOSIV
TPC8119 ☆	-30	±20	-10		13	—	28	—	40	1560	U-MOSV
TPC8121 ☆	-30	±20	-11		12	—	24	—	42	1770	U-MOSV
TPC8111	-30	±20	-11		12	—	18	—	107	5710	U-MOSIV
TPC8113	-30	±20	-11		10	—	18	—	107	4500	U-MOSIV
TPC8123 ☆	-30	-25/+20	-11		9	12.5	—	—	68	2940	U-MOSVI
TPC8122 ☆	-30	±20	-12		8	—	16.5	—	62	2450	U-MOSV
TPC8118 ☆	-30	±20	-13		7	—	15	—	65	2700	U-MOSV
TPC8114	-30	±20	-18		4.5	—	6.8	—	180	7480	U-MOSIV
TPC8117 ☆	-30	±20	-18		3.9	—	7.9	—	130	4600	U-MOSV
TPC8120 ☆	-30	-25/+20	-18		3.2	4.2	—	—	180	7420	U-MOSVI
TPC8116-H	-40	±20	-7.5		30	37	—	—	27	1190	U-MOSIII-H
TPC8110	-40	±20	-8	25	—	35	—	48	2180	U-MOSIII	
TPC8405	30	±20	6	N-ch/P-ch Dual	26	33	—	—	27	1240	U-MOSIII
	-30	±20	-4.5		33	42	—	—	40	1540	U-MOSIV
TPC8406-H	40	±20	6.5		27	35	—	—	11	650	U-MOSIII-H
	-40	±20	-6.5		30	37	—	—	27	1190	U-MOSIII-H
TPC8404	250	±20	1.1	1.7	—	—	—	10	267	π -MOSV	
	-250	±20	-0.9	2.55	—	—	—	12	381	π -MOSV	
TPC8A01	30	±20	6	N-ch/ N-ch + SBD	25	30	—	—	17	940	U-MOSIII
	30	±20	8.5/1		18	21	—	—	49	2295	U-MOSIII
TPC8A05-H ☆	30	±20	10/1	MOSBD	13.3	17.6	—	—	7.4	1300	U-MOSV-H
TPC8A06-H ☆	30	±20	12/1		10.1	12.9	—	—	9.6	1400	U-MOSV-H
TPC8A03-H ☆	30	±20	17/1		5.6	7	—	—	19	2640	U-MOSV-H
TPC8A04-H ☆	30	±20	18/1		3.6	4.5	—	—	29	4400	U-MOSV-H

☆: No protection Zener diode between gate and source

● SOP Advance Series ... [Part Number: TPCA8xxx]

■ Features

- Low ON-resistance and high-speed-switching series are available.
Low ON-resistance series: U-MOSIV/V
High-speed-switching series: U-MOSIII-H, U-MOSV-H and U-MOSVI-H
- High-current, thin and thermally enhanced package

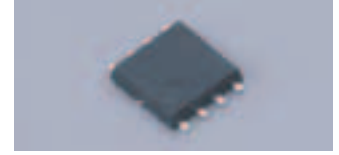

■ Product Offerings

Part Number	Absolute Maximum Ratings			Circuit Configuration	R _{DS(ON)} Max (mΩ)					Q _g Typ. (nC)	C _{iss} Typ. (pF)	Series
	V _{DSS} (V)	V _{GSS} (V)	I _D (A)		10 V	4.5 V	4 V	2.5 V	1.8 V			
TPCA8011-H	20	±12	40	N-ch Single	—	3.5	—	7.5	—	32	2900	U-MOSIII-H
TPCA8040-H ☆	30	±20	23		9.4	10.8	—	—	—	11.7	1700	U-MOSVI-H
TPCA8030-H ☆	30	±20	24		11.0	13.4	—	—	—	83	1433	U-MOSV-H
TPCA8031-H ☆	30	±20	24		11.0	13.4	—	—	—	83	1433	U-MOSV-H
TPCA8018-H ☆	30	±20	30		6.2	8.2	—	—	—	18	2270	U-MOSV-H
TPCA8039-H ☆	30	±20	34		5.7	6.6	—	—	—	19	2600	U-MOSVI-H
TPCA8024 ☆	30	±20	35		4.3	7.8	—	—	—	45	1800	U-MOSIV
TPCA8036-H ☆	30	±20	38		4.2	4.8	—	—	—	26	3500	U-MOSVI-H
TPCA8012-H ☆	30	±20	40		4.9	6.8	—	—	—	22	2900	U-MOSV-H
TPCA8025 ☆	30	±20	40		3.5	6.0	—	—	—	49	2200	U-MOSIV
TPCA8060-H ☆	30	±20	45		3.4	3.9	—	—	—	34	4600	U-MOSVI-H
TPCA8042 ☆	30	±20	45		3.3	5.7	—	—	—	56	2900	U-MOSIV
TPCA8019-H ☆	30	±20	45		3.1	4.1	—	—	—	34	4614	U-MOSV-H
TPCA8026 ☆	30	±20	45		2.2	4.5	—	—	—	113	4200	U-MOSIV
TPCA8028-H ☆	30	±20	50		2.8	3.2	—	—	—	46	6000	U-MOSVI-H
TPCA8020-H	40	±20	7.5		27	35	—	—	—	11	650	U-MOSIII-H
TPCA8052-H ☆	40	±20	20		11.3	13.1	—	—	—	13	1620	U-MOSVI-H
TPCA8014-H	40	±20	30		9	14	—	—	—	22	1365	U-MOSIII-H
TPCA8027-H	40	±20	30		10	—	—	—	—	23	1430	U-MOSIII-H
TPCA8047-H ☆	40	±20	32		7.3	8.5	—	—	—	23	2590	U-MOSVI-H
TPCA8015-H	40	±20	35		5.4	7.9	—	—	—	37	2155	U-MOSIII-H
TPCA8046-H ☆	40	±20	38		5.4	6.3	—	—	—	29	3545	U-MOSVI-H
TPCA8045-H ☆	40	±20	46		3.6	4.1	—	—	—	47	5800	U-MOSVI-H
TPCA8053-H ☆	60	±20	15		22.3	24	—	—	—	13	1620	U-MOSVI-H
TPCA8050-H ☆	60	±20	24		14.2	15.3	—	—	—	21	2590	U-MOSVI-H
TPCA8016-H	60	±20	25		21	26	—	—	—	22	1375	U-MOSIII-H
TPCA8049-H ☆	60	±20	28		10.4	11.2	—	—	—	29	3545	U-MOSVI-H
TPCA8048-H ☆	60	±20	35		6.6	7.1	—	—	—	46	5800	U-MOSVI-H
TPCA8051-H ☆	80	±20	28		9.4	9.8	—	—	—	47	5800	U-MOSVI-H
TPCA8006-H	100	±20	18		67	—	—	—	—	12	780	π-MOSVII
TPCA8022-H	100	±20	22		26	—	—	—	—	38	2330	U-MOSIII-H
TPCA8009-H	150	±20	7		350	—	—	—	—	10	600	π-MOSV MACHII
TPCA8010-H	200	±20	5.5	450	—	—	—	—	10	600	π-MOSV MACHII	
TPCA8008-H	250	±20	4	580	—	—	—	—	10	600	π-MOSV MACHII	
TPCA8105	-12	±8	-6	—	33	—	51	92	18	1600	U-MOSIV	
TPCA8103	-30	±20	-40	4.2	—	6.8	—	—	184	7880	U-MOSIV	
TPCA8106 ☆	-30	±20	-40	3.7	—	7.8	—	—	120	4600	U-MOSV	
TPCA8107-H	-40	±20	-7.5	30	37	—	—	—	27	1190	U-MOSIII-H	
TPCA8108	-40	±20	-40	9.5	—	—	—	—	100	4820	U-MOSIII	
TPCA8104	-60	±20	-40	16	—	24	—	—	90	4300	U-MOSIII	
TPCA8A05-H ☆	30	±20	10	12.9	17.2	—	—	—	7.4	1300	U-MOSV-H	
TPCA8A02-H ☆	30	±20	34	5.3	6.7	—	—	—	19	2640	U-MOSV-H	
TPCA8A08-H ☆	30	±20	38	4.2	5.3	—	—	—	24	3500	U-MOSV-H	
TPCA8A04-H *☆	30	±20	42	3.2	4.1	—	—	—	30	4400	U-MOSV-H	

☆: No protection Zener diode between gate and source *☆: Under development

● DPAK Series ... [Part Number: TKxxPxxxM1]

■ Features

- High-current, thermally enhanced package

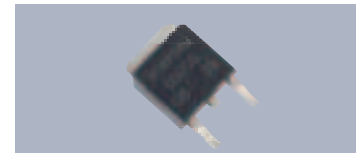

■ Product Offerings

Part Number	Absolute Maximum Ratings			Circuit Configuration	R _{DS(ON)} Max (mΩ)		Q _g Typ. (nC)	C _{iss} Typ. (pF)	Series
	V _{DSS} (V)	V _{GSS} (V)	I _D (A)		10 V	4.5 V			
TK40P03M1 ☆	30	±20	40	N-ch Single	10.8	14.4	9.4	1150	U-MOSVI-H
TK50P03M1 ☆	30	±20	50		7.5	9.8	13.3	1700	U-MOSVI-H
TK40P04M1 ☆	40	±20	40		10.3	13.4	29	1920	U-MOSVI-H
TK50P04M1 ☆	40	±20	50		8.7	10.2	38	2600	U-MOSVI-H

☆: No protection Zener diode between gate and source

4-7 Standard MOSFET Series ($I_D < 500$ mA)

Single MOSFETs

Polarity	Absolute Maximum Ratings			Package						V_{th} (V)	$R_{DS(ON)}$ Typ. (Max) (Ω)	V_{GS} (V)
	V_{DSS} (V)	V_{GSS} (V)	I_D (mA)	S-Mini (SOT-346) 2925 size, 3-pin	USM (SOT-323) 2021 size, 3-pin	UFM 2021 size, 3-pin	SSM (SOT-416) 1616 size, 3-pin	VSEM (SOT-723) 1212 size, 3-pin	CST3 1006 size, 3-pin			
N-ch	20	± 10	180	—	—	—	SSM3K35FS	SSM3K35MFV	SSM3K35CT	0.4 to 1.0	5 (20)	1.2
	20	± 10	100	—	SSM3K16FU	—	SSM3K16FS	SSM3K16FV	SSM3K16CT	0.6 to 1.1	5.2 (15)	1.5
	20	± 10	500	—	—	SSM3K36TU	SSM3K36FS	SSM3K36MFV	—	0.35 to 1.0	0.95 (1.52)	1.5
	20	± 10	500	—	—	—	SSM3K43FS	—	—	0.35 to 1.0	0.95 (1.52)	1.5
	20	10	100	—	—	—	—	SSM3K03FV	—	0.7 to 1.3	4 (12)	2.5
	20	10	100	—	**SSM3K04FU	—	**SSM3K04FS	**SSM3K04FV	—	0.7 to 1.3	4 (12)	2.5
	20	± 12	400	—	SSM3K05FU	—	—	—	—	0.6 to 1.1	0.85 (1.20)	2.5
	30	± 20	100	SSM3K15F	SSM3K15FU	—	SSM3K15FS	SSM3K15FV	SSM3K15CT	0.8 to 1.5	4.0 (7.0)	2.5
	30	± 20	100	—	—	—	SSM3K44FS	SSM3K44MFV	—	0.8 to 1.5	4.0 (7.0)	2.5
	30	± 20	200	2SK2009	—	—	—	—	—	0.5 to 1.5	1.2 (2.0)	2.5
	30	± 20	400	—	SSM3K09FU	—	—	—	—	1.1 to 1.8	0.8 (1.2)	4.0
	50	± 7	100	—	SSM3K17FU	—	—	—	—	0.9 to 1.5	22 (40)	2.5
	60	± 20	200	2SK1062	—	—	—	—	—	2.0 to 3.5	0.6 (1.0)	10
	60	± 20	200	SSM3K7002F	SSM3K7002FU	—	—	—	—	1.0 to 2.5	2.2 (3.3)	4.5
	60	± 20	200	SSM3K7002AF	SSM3K7002AFU	—	—	—	—	1.0 to 2.5	1.8 (3.3)	4.5
	60	± 20	200	SSM3K7002BF	SSM3K7002BFU	—	SSM3K7002BFS	—	—	1.5 to 3.1	2.1 (3.3)	4.5
P-ch	-20	± 10	-100	—	—	—	SSM3J35FS	SSM3J35MFV	SSM3J35CT	-0.4 to -1.0	11 (44)	-1.2
	-20	± 10	-100	—	SSM3J16FU	—	SSM3J16FS	SSM3J16FV	SSM3J16CT	-0.6 to -1.1	18 (45)	-1.5
	-20	± 8	-330	—	—	SSM3J36TU	SSM3J36FS	SSM3J36MFV	—	-0.3 to -1.0	2.23 (3.6)	-1.5
	-20	± 12	-200	—	SSM3J05FU	—	—	—	—	-0.6 to -1.1	3.2 (4.0)	-2.5
	-30	± 20	-100	SSM3J15F	SSM3J15FU	—	SSM3J15FS	SSM3J15FV	SSM3J15CT	-1.1 to -1.7	14 (32)	-2.5
	-30	± 20	-200	2SJ305	—	—	—	—	—	-0.5 to -1.5	2.4 (4.0)	-2.5
	-30	± 20	-200	—	SSM3J09FU	—	—	—	—	-1.1 to -1.8	3.3 (4.2)	-4.0
	-50	-7	-50	2SJ343	2SJ344	—	—	—	—	-0.8 to -2.5	20 (50)	-4.0
	-60	± 20	-200	2SJ168	—	—	—	—	—	-2.0 to -3.5	1.3 (2.0)	-10

** : Built-in 1-M Ω gate-source resistor

Dual MOSFETs

Polarity	Absolute Maximum Ratings			Package					V_{th} (V)	$R_{DS(ON)}$ Typ. (Max) (Ω)	V_{GS} (V)	Constituent Devices	
	V_{DSS} (V)	V_{GSS} (V)	I_D (mA)	US6 (SOT-363) 2021 size, 6-pin	UF6 2021 size, 6-pin	USV (SOT-353) 2021 size, 5-pin	ES6 (SOT-563) 1616 size, 6-pin	ESV (SOT-553) 1616 size, 5-pin					CST6D 1009 size, 6-pin
N-chx2	20	± 10	180	SSM6N35FU	—	—	SSM6N35FE	—	—	0.4 to 1.0	5 (20)	1.2	SSM3K35FSx2
	20	± 10	100	SSM6N16FU	—	SSM5N16FU	SSM6N16FE	SSM5N16FE	—	0.6 to 1.1	5.2 (15)	1.5	SSM3K16FUx2
	20	± 10	250	—	—	—	—	—	SSM6N37CTD	0.35 to 1.0	3.07 (5.6)	1.5	—
	20	± 10	500	—	SSM6N36TU	—	SSM6N36FE	—	—	0.35 to 1.0	0.95 (1.52)	1.5	SSM3K36FSx2
	20	± 10	500	SSM6N43FU	—	—	—	—	—	0.35 to 1.0	0.95 (1.52)	1.5	SSM3K43FSx2
	20	10	100	—	—	—	SSM6N03FE	SSM5N03FE	—	0.7 to 1.3	4 (12)	2.5	SSM3K03FEx2
	20	10	100	**SSM6N04FU	—	—	—	—	—	0.7 to 1.3	4 (12)	2.5	SSM3K04FUx2
	20	± 12	400	SSM6N05FU	—	SSM5N05FU	—	—	—	0.6 to 1.1	0.85 (1.2)	2.5	SSM3K05FUx2
	30	± 20	100	SSM6N15FU	—	SSM5N15FU	SSM6N15FE	SSM5N15FE	—	0.8 to 1.5	4.0 (7.0)	2.5	SSM3K15FUx2
	30	± 20	100	SSM6N44FU	—	—	SSM6N44FE	—	—	0.8 to 1.5	4.0 (7.0)	2.5	SSM3K44FSx2
	30	± 20	400	SSM6N09FU	—	—	—	—	—	1.1 to 1.8	0.8 (1.2)	4.0	SSM3K09FUx2
	50	± 7	100	SSM6N17FU	—	—	—	—	—	0.9 to 1.5	22 (40)	2.5	SSM3K17FUx2
	60	± 20	200	SSM6N7002FU	—	—	—	—	—	1.0 to 2.5	2.2 (3.3)	4.5	SSM3K7002FUx2
	60	± 20	200	SSM6N7002AFU	—	—	—	—	—	1.0 to 2.5	1.8 (3.3)	4.5	SSM3K7002AFUx2
	60	± 20	200	SSM6N7002BFU	—	—	—	SSM6N7002BFE	—	1.5 to 3.1	2.1 (3.3)	4.5	SSM3K7002BFUx2
	P-chx2	-20	± 10	-100	SSM6P35FU	—	—	SSM6P35FE	—	—	-0.4 to -1.0	11 (44)	-1.2
-20		± 10	-100	SSM6P16FU	—	SSM5P16FU	SSM6P16FE	SSM5P16FE	—	-0.6 to -1.1	18 (45)	-1.5	SSM3J16FUx2
-20		± 8	-330	—	SSM6P36TU	—	SSM6P36FE	—	—	-0.3 to -1.0	2.23 (3.6)	-1.5	SSM3J36FSx2
-20		± 12	-200	SSM6P05FU	—	SSM5P05FU	—	—	—	-0.6 to -1.1	3.2 (4.0)	-2.5	SSM3J05FUx2
-30		± 20	-100	SSM6P15FU	—	SSM5P15FU	SSM6P15FE	SSM5P15FE	—	-1.1 to -1.7	14 (32)	-2.5	SSM3J15FUx2
-30		± 20	-200	SSM6P09FU	—	—	—	—	—	-1.1 to -1.8	3.3 (4.2)	-4.0	SSM3J09FUx2
N-ch+ P-ch	20	± 10	180	—	—	—	SSM6L35FE	—	—	0.4 to 1.0	5 (20)	1.2	SSM3K35FS
	-20	± 10	-100	SSM6L35FU	—	—	—	—	—	-0.4 to -1.0	11 (44)	-1.2	+SSM3J35FS
	20	± 10	100	—	—	—	SSM6L16FE	—	—	0.6 to 1.1	5.2 (15)	1.5	SSM3K16FS
	-20	± 10	-100	—	—	—	—	—	—	-0.6 to -1.1	18 (45)	-1.5	+SSM3J16FS
	20	± 10	500	—	SSM6L36TU	—	SSM6L36FE	—	—	0.35 to 1.0	0.95 (1.52)	1.5	SSM3K36FS
	-20	± 8	-330	—	—	—	—	—	—	-0.3 to -1.0	2.23 (3.6)	-1.5	+SSM3J36FS
	20	± 12	400	SSM6L05FU	—	—	—	—	—	0.6 to 1.1	0.85 (1.2)	2.5	SSM3K05FU
	-20	± 12	-200	—	—	—	—	—	—	-0.6 to -1.1	3.2 (4.0)	-2.5	+SSM3J05FU
30	± 20	400	SSM6L09FU	—	—	—	—	—	1.1 to 1.8	0.8 (1.2)	4.0	SSM3K09FU	
-30	± 20	-200	—	—	—	—	—	—	-1.1 to -1.8	3.3 (4.2)	-4.0	+SSM3J09FU	

** : Built-in 1-M Ω gate-source resistor

5-1 TO-220SM(W) Series

The TO-220SM(W) package, which uses Cu connectors and a wide source terminal, realizes low ON-resistance and a high current-carrying capability.

■ Features

- Achieves low ON-resistance, low package inductance and low thermal resistance due to the use of Cu connectors.
- Achieves a high current-carrying capability due to the use of a wide source terminal (I_D (DC) = 150 A max)
- AEC-Q101-qualified at a channel temperature (T_{ch}) of 175°C
- Thin package: 3.7-mm (max) thick, much thinner than the previous TO-220SM package with a thickness of 4.7 mm (max)

■ Characteristics of the WARP Series

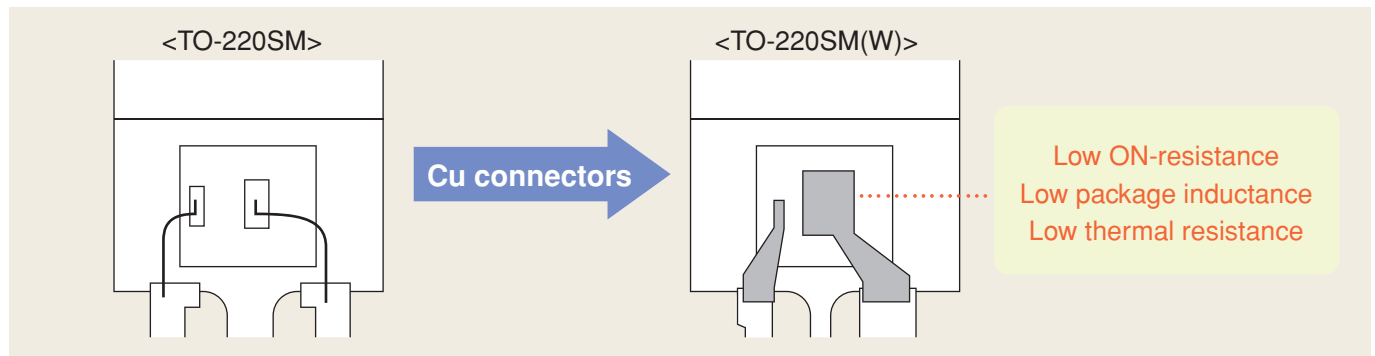

■ Package

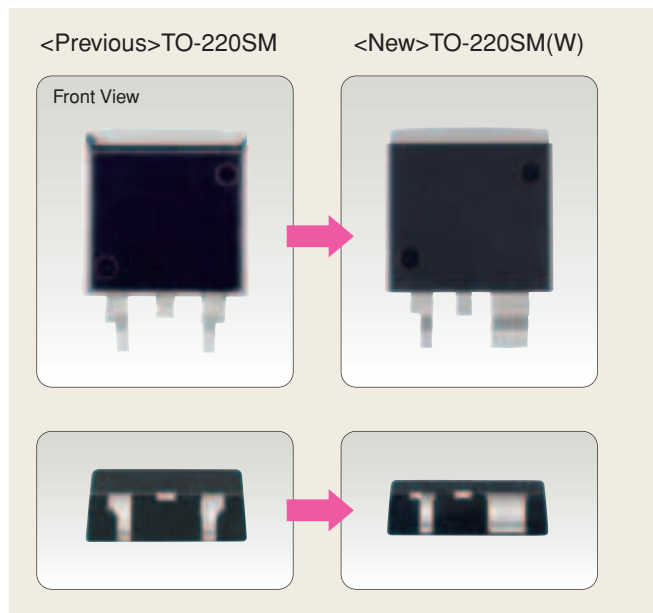

■ Comparison of the Source Lead Temperature

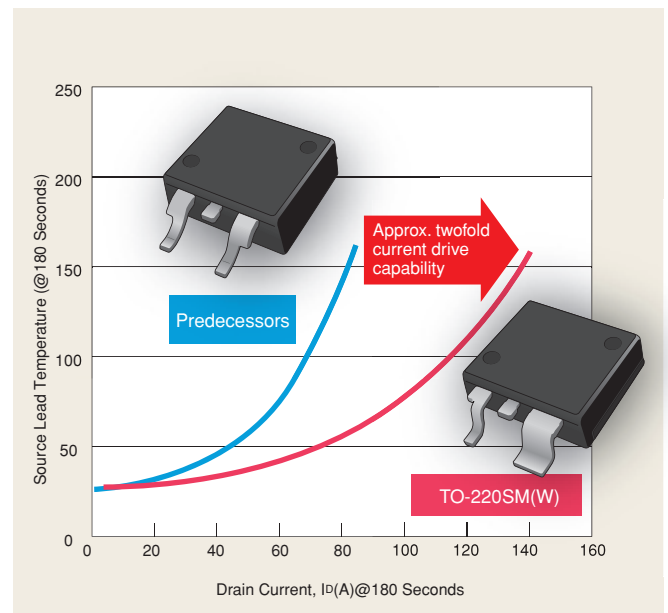

■ Product Offerings

Part Number	Absolute Maximum Ratings			$R_{DS(ON)}$ Max (m Ω)		C_{iss} Typ. (pF)	Q_g Typ. (nC)	Series
	V_{DSS} (V)	V_{GS} (V)	I_D (A)	$V_{GS} = 10$ V	$V_{GS} = 6$ V			
TJ120F06J3	-60	± 20	-120	8	—	11500	258	U-MOSIII
TK100F04K3	40	± 20	100	3	—	4500	102	U-MOSIV
TK100F04K3L	40	± 20	100	3	4.5	4980	105	U-MOSIV
TK150F04K3	40	± 20	150	2.1	—	7500	166	U-MOSIV
TK150F04K3L	40	± 20	150	2.1	3.2	9400	190	U-MOSIV
TK100F06K3	60	± 20	100	5	—	4500	98	U-MOSIV
TK130F06K3	60	± 20	130	3.4	—	8400	170	U-MOSIV
TK50F15J1	150	± 20	50	30	—	4300	75	U-MOSIII

5-2 U-MOS (Trench Type) Series

Fabricated using a trench structure, the U-MOS Series ultra-high integration density and thus

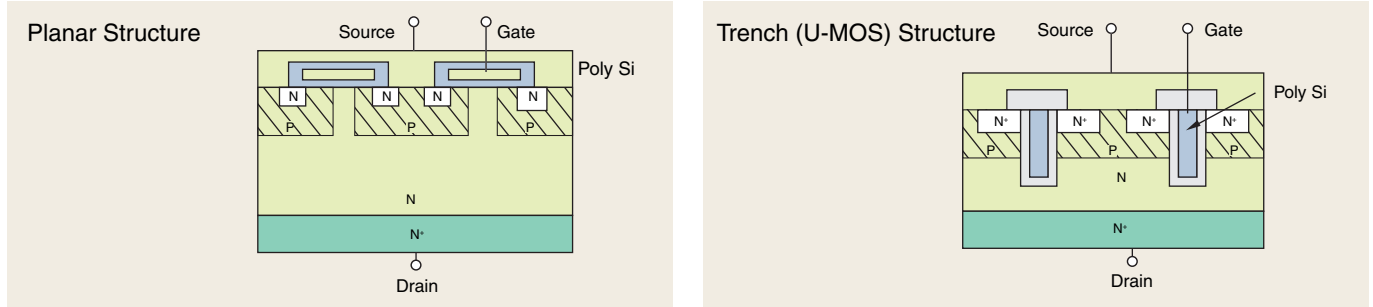

■ Features

- High density through the use of submicron technology
- 60% reduction in $R_{DS(ON)}$ by per unit area (as compared with the maximum $R_{DS(ON)}$ of L^2 - π -MOSV)
- Guaranteed avalanche capability and improved di/dt rate

■ Product Offerings

Applications	Part Number	Absolute Maximum Ratings				Package	$R_{DS(ON)}$ Max (m Ω)				Q_g Typ. (nC)	Series
		V_{DS} (V)	V_{GS} (V)	I_D (A)	P_D (W)		10 V	6 V	4.5 V	4 V		
motor drive Solenoids Lamp drivers DC-DC converters	2SJ668	-60	± 20	-5	20	PW-Mold	170	—	—	250	15	U-MOSIII
	2SJ681	-60	± 20	-5	20	New PW-Mold2	170	—	—	250	15	
	2SJ669	-60	± 20	-5	1.2	TPS	170	—	—	250	15	
	TPCA8104	-60	± 20	-40	45	SOP Advance	16	—	—	24	90	
	TJ70A06J3	-60	± 20	-70	54	TO-220SIS	8.0	—	10	—	246	
	TJ120F06J3	-60	± 20	-120	300	TO-220SM(W)	8.0	—	—	—	258	
LCD backlight inverter	TJ20A10M3 ☆	-100	± 20	-20	35	TO-220SIS	90	—	—	—	120	U-MOSVI
motor drive Solenoids Lamp drivers DC-DC converters	2SK3754	30	± 20	5	25	TO-220NIS	89	—	99	—	2.5	U-MOSIII
	2SK3846	40	± 20	26	25	TO-220NIS	16	—	28	—	40	
	2SK3847	40	± 20	32	30	TO-220SM	16	—	28	—	40	U-MOSIV
	TK70J04J3	40	± 20	70	150	TO-3P(N)	3.8	—	8.3	—	210	
	TK70X04K3 ☆	40	± 20	70	80	TFP	5.6	—	—	—	62	U-MOSIII
	TK70X04K3Z	40	± 20	70	80	TFP	5.6	—	—	—	62	
	2SK3843	40	± 20	75	125	TFP	3.5	—	8.0	—	210	U-MOSIV
	TK80X04K3 ☆	40	± 20	80	125	TFP	3.5	—	—	—	100	
	TK100F04K3 ☆	40	± 20	100	200	TO-220SM(W)	3.0	—	—	—	102	U-MOSIII
	TK100F04K3L	40	± 20	100	200	TO-220SM(W)	3.0	4.5	—	—	105	
	TK150F04K3 ☆	40	± 20	150	300	TO-220SM(W)	2.1	—	—	—	166	U-MOSIV
	TK150F04K3L	40	± 20	150	300	TO-220SM(W)	2.1	3.2	—	—	190	
	2SK4017	60	± 20	5	20	New PW-Mold2	100	—	—	150	15	U-MOSIII
	2SK4033	60	± 20	5	20	New PW-Mold	100	—	—	150	15	
	TK30A06J3A	60	± 20	30	25	TO-220SIS	26	—	35	—	36	U-MOSIV
	2SK3662	60	± 20	35	35	TO-220NIS	12.5	—	—	19	91	
	2SK3844	60	± 20	45	45	TO-220NIS	5.8	—	—	—	196	U-MOSIII
	TK70X06K3 ☆	60	± 20	70	80	TFP	8.0	—	—	—	62	
	2SK3845	60	± 20	70	125	TO-3P(N)	5.8	—	—	—	196	U-MOSIII
	2SK3842	60	± 20	75	125	TFP	5.8	—	—	—	196	
2SK4034	60	± 20	75	125	TFP	5.8	—	10	—	196	U-MOSIII	
2SK3940	75	± 20	70	150	TO-3P(N)	7.0	—	—	—	200		
LCD backlight inverter	TK25A10K3 ☆	100	± 20	25	25	TO-220SIS	40	—	—	—	34	U-MOSIV
	TK40X10J1	100	± 20	40	125	TFP	20	—	—	—	59	U-MOSIII
	TK50F15J1	150	± 20	50	300	TO-220SM(W)	30	—	—	—	75	

☆: No protection Zener diode between gate and source

5-3 U-MOS Series for Synchronous Rectification ($V_{DS} = 60\text{ V to }150\text{ V}$)

■ Features

- Low ON-resistance achieved by high density through the use of submicron technology
- Guaranteed avalanche capability
- High power dissipation achieved by having the series housed in the TO-220(W) package with an exposed heatsink on the bottom of the package

■ Comparisons Between Synchronous Rectification MOSFETs

Characteristic	Symbol	Test Conditions	TK80A08K3			TK60A08J1			Unit
			Min	Typ.	Max	Min	Typ.	Max	
Gate leakage current	+I _{GSS}	V _{GS} condition*, V _{DS} = 0 V	—	—	1	—	—	10	μA
	-I _{GSS}	V _{GS} condition*, V _{DS} = 0 V	—	—	-1	—	—	-10	μA
Drain cut-off current	I _{DSS}	V _{DS} = 75 V, V _{GS} = 0 V	—	—	10	—	—	10	μA
Drain-source breakdown voltage	V _{(BR) DSS}	I _D = 10 mA, V _{GS} = 0 V	75	—	—	75	—	—	V
	V _{(BR) DSX}	I _D = 10 mA, V _{GS} = -20 V	50	—	—	60	—	—	V
Gate threshold voltage	V _{th}	V _{DS} = 10 V, I _D = 1 mA	2.0	—	4.0	1.1	—	2.3	V
Drain-source ON-resistance	R _{DS(ON)}	V _{GS} = 10 V, I _D = 40 A	—	3.6	4.5	—	6.2	7.8	mΩ
Input capacitance	C _{iss}	V _{DS} = 10 V, V _{GS} = 0 V f = 1 MHz	—	8200	—	—	5450	—	pF
Reverse transfer capacitance	C _{rss}		—	770	—	—	320	—	pF
Forward voltage	V _{DSF}	I _{DR} = 80 A, V _{GS} = 0 V	—	-0.9	-1.2	—	-0.9	-1.2	V

*: Test conditions: TK80A08K3: V_{GS} = ±20 V, TK60A08J1: V_{GS} = ±16 V

■ Efficiency Test Circuit

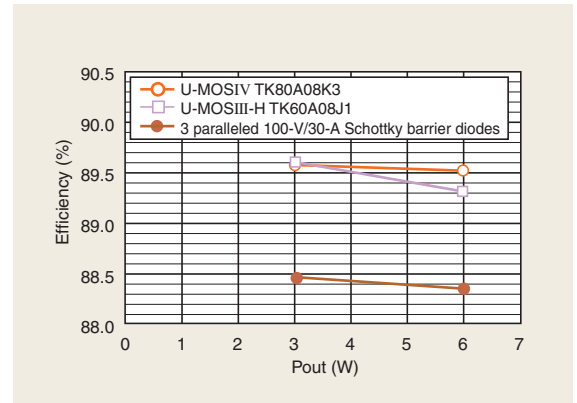
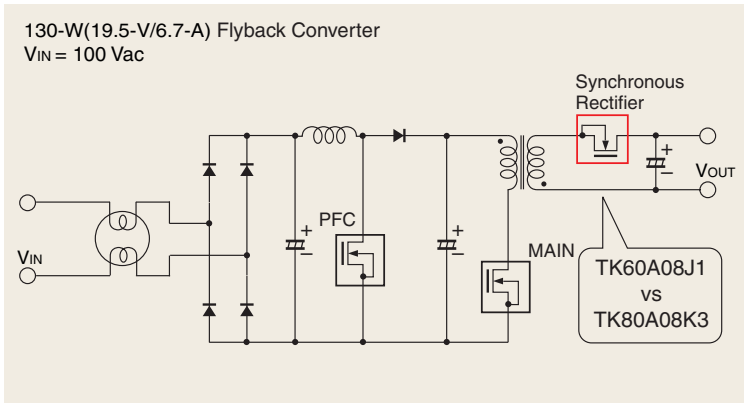

Efficiency approx. 1% higher than Schottky barrier diodes

■ Product Offerings

Part Number	Absolute Maximum Ratings				R _{DS(ON)} (mΩ) @ V _{GS} = 10 V		Q _g (nC) Typ.	Q _{sw} (nC) Typ.	Package	Series
	V _{DS} (V)	V _{GSS} (V)	I _D (A)	P _D (W)	Typ.	Max				
TK70D06J1	60	±20	70	140	5.1	6.4	87	30	TO-220(W)	U-MOSIII-H
TK70A06J1	60	±20	70	45	5.1	6.4	87	30	TO-220SIS	U-MOSIII-H
TK60D08J1	75	±20	60	140	6.2	7.8	86	27	TO-220(W)	U-MOSIII-H
TK60A08J1	75	±20	60	45	6.2	7.8	86	27	TO-220SIS	U-MOSIII-H
TK40A08K3	75	±20	40	42	7.0	9.0	80	—	TO-220SIS	U-MOSIV
TK80D08K3	75	±20	80	100	3.6	4.5	175	80	TO-220(W)	U-MOSIV
TK80A08K3	75	±20	80	40	3.6	4.5	175	80	TO-220SIS	U-MOSIV
TK40A10K3	100	±20	40	40	11.5	15	85	40	TO-220SIS	U-MOSIV
TK40D10J1	100	±20	40	100	11.5	15	76	25	TO-220(W)	U-MOSIII-H
TK40A10J1	100	±20	40	40	11.5	15	76	25	TO-220SIS	U-MOSIII-H
TK40X10J1	100	±20	40	125	15	20	59	25	TFP	U-MOSIII-H
TK55D10J1	100	±20	55	140	8.4	10.5	110	33	TO-220(W)	U-MOSIII-H
TK55A10J1	100	±20	55	45	8.4	10.5	110	33	TO-220SIS	U-MOSIII-H
TK50X15J1	150	±20	50	125	22	30	75	33	TFP	U-MOSIII-H

6-1 π -MOSVII Series ($V_{DSS} = 450\text{ V to }650\text{ V}$)

The latest addition to the π -MOS portfolio, the π -MOSVII Series offers reduced capacitances due to optimized chip design and is available with a greatly wider range of electrical characteristics.

■ Features

- 40% reduction in Q_g from π -MOSVI due to optimized chip design
- Available in 50-V steps of V_{DSS} and in finer steps of $R_{DS(ON)}$.
- Rated avalanche and reverse recovery current capabilities

■ Performance Comparisons Between

π -MOSVII and π -MOSVI Devices (600 V/10 A)

Characteristic	Symbol	Test Conditions	π -MOSVII			π -MOSVI			Unit
			Min	Typ.	Max	Min	Typ.	Max	
Gate leakage current	$\pm I_{GSS}$	V_{GS} condition*, $V_{DS} = 0\text{ V}$	—	—	± 1	—	—	± 10	μA
Drain cut-off current	I_{DSS}	$V_{DS} = 600\text{ V}, V_{GS} = 0\text{ V}$	—	—	100	—	—	100	μA
Drain-source breakdown voltage	$V_{(BR)DSS}$	$I_D = +10\text{ mA}, V_{GS} = 0\text{ V}$	600	—	—	600	—	—	V
Gate threshold voltage	V_{th}	$V_{DS} = 10\text{ V}, I_D = 1\text{ mA}$	2.0	—	4.0	2.0	—	4.0	V
Drain-source ON-resistance	$R_{DS(ON)}$	$V_{GS} = 10\text{ V}, I_D = 5\text{ A}$	—	—	0.75	—	—	0.75	Ω
Total gate charge	Q_g	$V_{DD} = 400\text{ V}, V_{GS} = 10\text{ V}, I_D = 10\text{ A}$	—	25	—	—	42	—	nC
Diode forward voltage	V_{DSF}	$I_{DR} = 10\text{ A}, V_{GS} = 0\text{ V}$	—	—	-1.7	—	—	-1.7	V

*: Test conditions: TK10A60D: $V_{GS} = \pm 30\text{ V}$, 2SK3569: $V_{GS} = \pm 25\text{ V}$

■ Efficiency Test Circuit

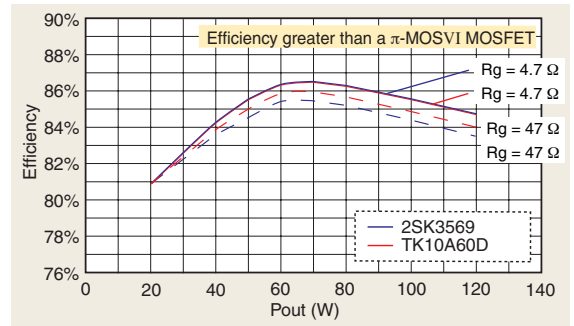
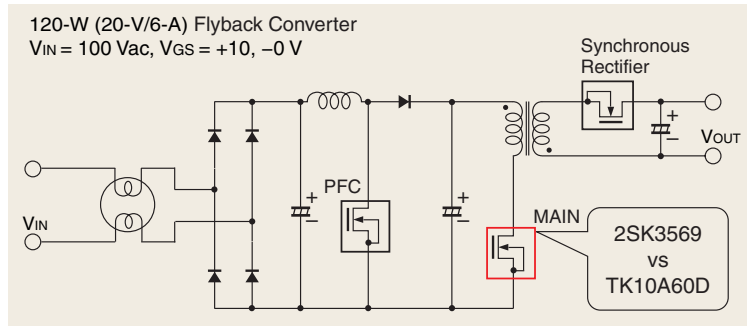

■ Product Offerings

Part Number	Absolute Maximum Ratings		$R_{DS(ON)}$ (Ω)	Equivalent π -MOSVI Part	Package	
	V_{DSS} (V)	I_D (A)				
TK13A45D	450	13	0.46	2SK3743	TO-220SIS	
TK4A50D		4	2.0	—	TO-220SIS	
TK5A50D		5	1.5	2SK3563	TO-220SIS	
TK6A50D		6	1.4	—	TO-220SIS	
TK7A50D		7	1.2	—	TO-220SIS	
TK8A50DA		7.5	1.0	—	TO-220SIS	
TK8A50D		8	0.85	2SK3561	TO-220SIS	
TK10A50D		10	0.72	—	TO-220SIS	
TK11A50D		500	11	0.6	—	TO-220SIS
TK12A50D			12	0.52	2SK3568	TO-220SIS
TK13A50DA			12.5	0.47	—	TO-220SIS
TK13A50D			13	0.4	2SK4012	TO-220SIS
TK15J50D			15	0.4	2SK4107	TO-3P(N)
TK15A50D			15	0.3	2SK3934	TO-220SIS
TK18A50D	18		0.27	—	TO-220SIS	
TK20J50D	20		0.27	2SK4108	TO-3P(N)	
TK4A53D	525		4	1.7	—	TO-220SIS
TK5A53D			5	1.5	2SK3563	TO-220SIS
TK6A53D		6	1.3	—	TO-220SIS	
TK6P53D		6	1.3	—	D-PAK	
TK12A53D		12	0.58	—	TO-220SIS	
TK12X53D		12	0.58	2SK3398	TFP	
TK4A55DA	550	3.5	2.45	—	TO-220SIS	
TK4A55D		4	1.9	—	TO-220SIS	
TK5A55D		5	1.7	—	TO-220SIS	
TK6A55DA		5.5	1.48	—	TO-220SIS	

Part Number	Absolute Maximum Ratings		$R_{DS(ON)}$ (Ω)	Equivalent π -MOSVI Part	Package	
	V_{DSS} (V)	I_D (A)				
TK8A55DA	550	7.5	1.07	—	TO-220SIS	
TK9A55DA		8.5	0.86	—	TO-220SIS	
TK11A55D		11	0.63	—	TO-220SIS	
TK12A55D		12	0.57	—	TO-220SIS	
TK12J55D		12	0.57	—	TO-3P(N)	
TK13A55DA		12.5	0.48	—	TO-220SIS	
TK14A55D		14	0.37	—	TO-220SIS	
TK16A55D *		16	0.33	—	TO-220SIS	
TK16J55D		16	0.37	—	TO-3P(N)	
TK2Q60D		600	2	5.0	2SK4002	New PW-Mold 2
TK3A60DA			2.5	2.8	—	TO-220SIS
TK4A60DA			3.5	2.2	2SK3567	TO-220SIS
TK4A60DB			3.7	2	—	TO-220SIS
TK4A60D			4	1.7	—	TO-220SIS
TK6A60D			6	1.25	2SK3562	TO-220SIS
TK8A60DA			7.5	1	2SK3667	TO-220SIS
TK10A60D	10		0.75	2SK3569	TO-220SIS	
TK11A60D	11		0.65	—	TO-220SIS	
TK12A60D	12		0.55	—	TO-220SIS	
TK13A60D	13	0.43	2SK3797	TO-220SIS		
TK15A60D	15	0.37	—	TO-220SIS		
TK5A65D	650	5	1.43	—	TO-220SIS	
TK6A65D		6	1.11	—	TO-220SIS	
TK8A65D		8	0.84	—	TO-220SIS	
TK12A65D *		12	0.50	—	TO-220SIS	

*: Under development

6-2 Super-Junction DT MOS Series ($V_{DSS} = 600\text{ V}, 650\text{ V}$)

The DT MOS devices employ a new super-junction structure that enables an ultra-low ON-resistance with the maximum V_{DSS} rating of 600 V. The DT MOS Series helps reduce the power consumption and size of electronic equipment.

■ Features

- Low ON-resistance TK40J60T: $80\text{ m}\Omega$ (max) @ $V_{GS} = 10\text{ V}, I_D = 20\text{ A}$
- Low gate charge TK20A60U: $Q_g = 27\text{ nC}$ typ., $600\text{ V} / 20\text{ A}$
- The rugged internal drain-source diode is not damaged at $di/dt = 500\text{ A}/\mu\text{s}$ ($@V_{DS} = 400\text{ V}, 150^\circ\text{C}$).

■ Product Offerings

Part Number	Absolute Maximum Ratings		$R_{DS(ON)}$ Max (Ω)	Q_g Typ. (nC)	C_{iss} Typ. (pF)	Package	Series
	V_{DSS} (V)	I_D (A)	$V_{GS} = 10\text{ V}$				
TK12A60U	600	12	0.4	14	720	TO-220SIS	DTMOSII
TK12D60U						TO-220(W)	
TK12J60U						TO-3P(N)	
TK15J60T		15	0.3	21	1200	TO-3P(N)	DTMOSI
TK15A60U		15	0.3	17	950	TO-220SIS	DTMOSII
TK15D60U						TO-220(W)	
TK15J60U						TO-3P(N)	
TK20A60T		20	0.19	30	1580	TO-220SIS	DTMOSI
TK20D60T						TO-220(W)	
TK20J60T						TO-3P(N)	
TK20A60U		20	0.19	27	1470	TO-220SIS	DTMOSII
TK20D60U						TO-220(W)	
TK20J60U						TO-3P(N)	
TK40J60T		40	0.08	67	3900	TO-3P(N)	DTMOSI
TK50J60U *	50	0.065	70	4300	TO-3P(N)	DTMOSII	
TK13A65U	650	13	0.38	17	950	TO-220SIS	DTMOSII

*: Under development

■ Performance Comparisons Between the New DT MOS and Conventional MOSFET (π -MOSVI) Devices (600 V/20 A)

Characteristic	Symbol	Test Conditions	Series			Series			Unit
			DTMOSII			π -MOSVI			
			Part Number	Min	Typ.	Max	Part Number	Min	
Gate leakage current	$\pm I_{GSS}$	V_{GS} condition*, $V_{DS} = 0\text{ V}$	—	—	± 1	—	—	± 10	μA
Drain cut-off current	I_{DSS}	$V_{DS} = 600\text{ V}, V_{GS} = 0\text{ V}$	—	—	100	—	—	100	μA
Drain-source breakdown voltage	$V_{(BR)DSS}$	$I_D = 10\text{ mA}, V_{GS} = 0\text{ V}$	600	—	—	600	—	—	V
Gate threshold voltage	V_{th}	$V_{DS} = 10\text{ V}, I_D = 1\text{ mA}$	3.0	—	5.0	2.0	—	4.0	V
Drain-source ON-resistance	$R_{DS(ON)}$	$V_{GS} = 10\text{ V}, I_D = 10\text{ A}$	—	0.165	0.19	—	0.22	0.32	Ω
Total gate charge	Q_g	$V_{DD} = 400\text{ V}, V_{GS} = 10\text{ V}$ $I_D = 20\text{ A}$	—	27	—	—	60	—	nC
Diode forward voltage	V_{DSF}	$I_{DR} = 20\text{ A}, V_{GS} = 0\text{ V}$	—	—	-1.7	—	—	-1.7	V

*: Test conditions: TK20J60U: $V_{GS} = \pm 30\text{ V}$, 2SK3911: $V_{GS} = \pm 25\text{ V}$

■ Figure-of-Merit (FOM) Comparison

$R_{on} \times Q_g$, the product of ON-resistance and total gate charge, is reduced by 62%, compared with the conventional MOSFETs with the same chip size.

* $R_{on} \times Q_g$ is a figure-of-merit index for the switching speed of MOSFETs.

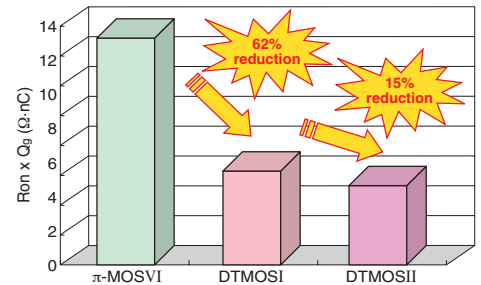

■ Performance Characteristics of the New DT MOS Series

TK20A60U Electrical Characteristics

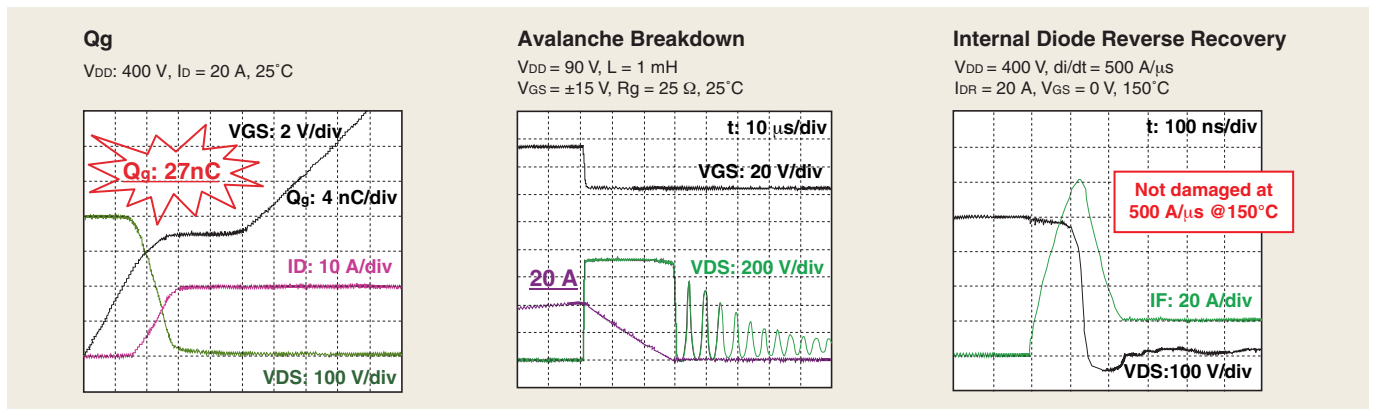

6-3 High-speed π -MOS Series ($V_{DSS} = 450\text{ V to }600\text{ V}$)

To support the development of high-efficiency equipment, Toshiba has developed two series of high-speed power MOSFETs: a high-speed switching series for AC adapters and switching power supplies; and a high-speed diode series for motor controllers and inverter circuits.

- MACH Series: Achieves a higher switching speed than the existing π -MOS Series, which is currently well established in the market.
- High-Speed Diode Series: Achieves a higher internal diode speed by using lifetime control.

■ Product Offerings

- MACH Series

Applications	Part Number	Absolute Maximum Ratings			Package	$R_{DS(ON)}$ Max (Ω)	V_{GS} (V)	I_D (A)	Q_g Typ. (nC)	Standard Type	Series
		V_{DSS} (V)	I_D (A)	P_D (W)							
AC adapters Switching power supplies	2SK3310	450	10	40	TO-220NIS	0.65	10	5	23	2SK3126	MACH-I
	2SK3309	450	10	65	TO-220FL/SM	0.65	10	5	23	—	
	2SK3743	450	13	40	TO-220NIS	0.4	10	6	34	—	
	2SK3403	450	13	100	TO-220FL/SM	0.4	10	6	34	—	
	2SK3312	600	6	65	TO-220FL/SM	1.25	10	3	25	2SK2777	
	2SK3437	600	10	80	TO-220FL/SM	1	10	5	28	2SK2996	
	2SK3399	600	10	100	TO-220FL/SM	0.75	10	5	35	2SK2866	
	2SK3907	500	23	150	TO-3P(N)	0.23	10	11.5	60	—	MACH-II
2SK3911	600	20	150	TO-3P(N)	0.32	10	10	60	—		

- High-Speed Diode Series (HSD Series)

Applications	Part Number	Absolute Maximum Ratings			Package	$R_{DS(ON)}$ Max (Ω)	V_{GS} (V)	I_D (A)	trr Typ. (ns)	Standard Type
		V_{DSS} (V)	I_D (A)	P_D (W)						
Motor control Inverters Switching power supplies	2SK3868	500	5	35	TO-220SIS	1.7	10	2.5	150	2SK3563
	2SK3417	500	5	50	TO-220FL/SM	1.8	10	2.5	60	2SK2991
	2SK4042	500	8	40	TO-220SIS	0.97	10	4	185	2SK3561
	2SK3313	500	12	40	TO-220NIS	0.62	10	6	90	2SK2842
	2SK3314	500	15	150	TO-3P(N)	0.49	10	7	105	2SK2698
	2SK3131	500	50	250	TO-3P(L)	0.11	10	25	105	2SK3132
	2SK3936	500	23	150	TO-3P(N)	0.25	10	11.5	380	2SK3907
	2SK3947	600	6	40	TO-220SIS	1.4	10	3	150	2SK3562
	2SK4015	600	10	45	TO-220SIS	0.86	10	5	170	2SK3569
	2SK4016	600	13	50	TO-220SIS	0.50	10	6.5	160	2SK3911
	2SK3906	600	20	150	TO-3P(N)	0.33	10	10	400	2SK3797

■ Characteristics of the MACHII Series

40% reduction in Q_g losses

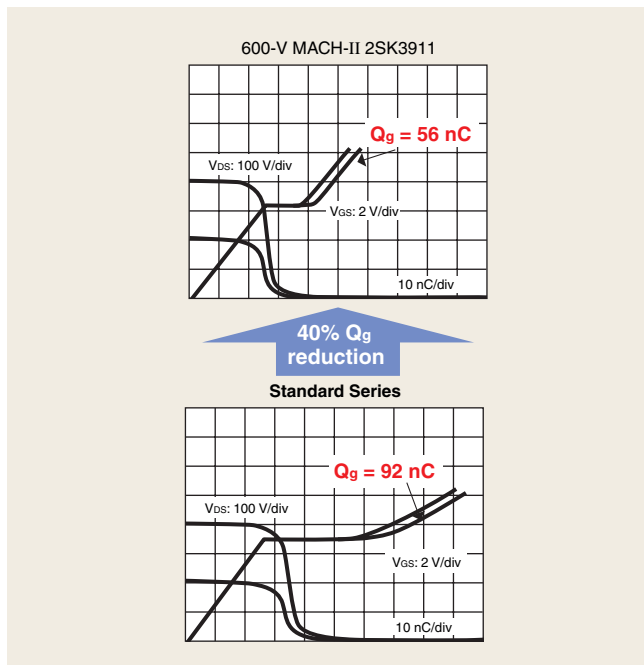

■ Characteristics of the High-Speed Diode Series

Faster internal diode

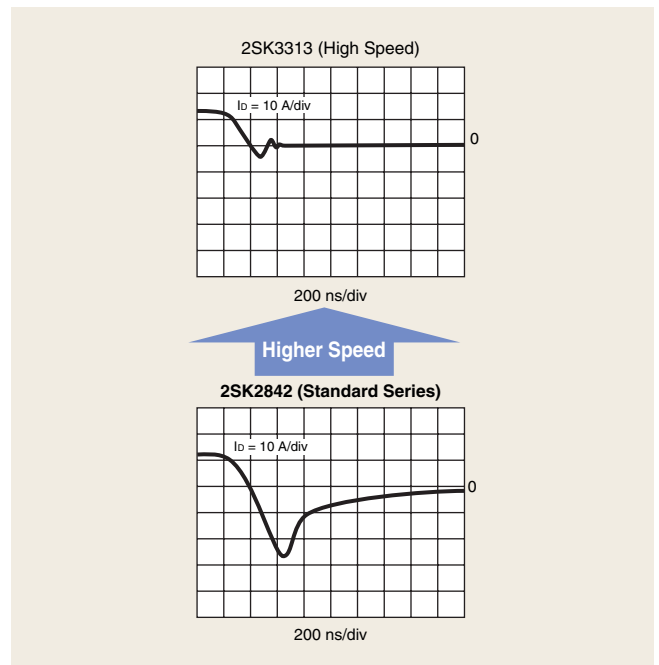

6-4 π -MOS Series

■ π -MOSVI Series ($V_{DSS} = 450\text{ V to }600\text{ V}$)

Series	Part Number	Absolute Maximum Ratings		$R_{DS(ON)}$ Max (Ω)		Q_g Typ. (nC)	C_{iss} Typ. (pF)	Equivalent Predecessor Part	Package
		V_{DSS} (V)	I_D (A)	$V_{GS} = 10\text{ V}$					
π -MOSVI	2SK3757	450	2	2.45	9	330	2SK3543	TO-220SIS	
	2SK3766		2	2.45	8	270	2SK3543	TO-220SIS	
	2SK3869		10	0.68	28	1050	2SK3407	TO-220SIS	
	2SK3935		17	0.25	62	3100	—	TO-220SIS	
	2SK3904		19	0.26	62	3100	—	TO-3P(N)	
	2SK3563		5	1.5	16	550	2SK2662	TO-220SIS	
	2SK3863	5	1.5	16	550	—	DP		
	2SK4103	5	1.5	16	550	2SK3863	New Pw-Mold		
	2SK3561	8	0.85	28	1050	2SK2543	TO-220SIS		
	2SK3568	12	0.52	42	1500	2SK2842	TO-220SIS		
	2SK4012	13	0.4	50	2400	—	TO-220SIS		
	2SK3934	15	0.3	62	3100	—	TO-220SIS		
	2SK4107	15	0.4	48	2450	2SK2698	TO-3P(N)		
	2SK3905	17	0.31	62	3100	—	TO-3P(N)		
	2SK4108	20	0.27	70	3400	2SK2837	TO-3P(N)		
	2SK3767	2	4.5	9	320	2SK3067	TO-220SIS		
	2SK3567	3.5	2.2	17	550	2SK2750	TO-220SIS		
	2SK3562	6	1.25	28	1050	2SK2545	TO-220SIS		
	2SK3667	7.5	1.0	33	1300	2SK2996	TO-220SIS		
	2SK3569	10	0.75	42	1500	2SK2843	TO-220SIS		
2SK3797	13	0.43	62	3150	—	TO-220SIS			
2SK3903	14	0.44	62	3100	—	TO-3P(N)			

■ π -MOSIV Series ($V_{DSS} = 800\text{ V to }900\text{ V}$)

Series	Part Number	Absolute Maximum Ratings		$R_{DS(ON)}$ Max (Ω)		Q_g Typ. (nC)	C_{iss} Typ. (pF)	Equivalent Predecessor Part	Package
		V_{DSS} (V)	I_D (A)	$V_{GS} = 10\text{ V}$					
π -MOSIV	2SK3633	800	7	1.7	35	1500	2SK2746	TO-3P(N)	
	2SK3879		6.5	1.7	35	1500	—	TO-220FL/SM	
	2SK3880		6.5	1.7	35	1500	—	TO-3P(N)IS	
	2SK4013		6	1.7	45	1400	—	TO-220SIS	
	2SK3566		2.5	6.4	12	470	2SK2718	TO-220SIS	
	2SK3564		3	4.3	17	700	2SK2700	TO-220SIS	
	2SK3798	4	3.5	26	800	—	TO-220SIS		
	2SK3565	5	2.5	28	1150	2SK2717	TO-220SIS		
	2SK3742	5	2.5	25	1150	2SK2717	TO-220SIS		
	2SK3700	5	2.5	28	1150	2SK2610	TO-3P(N)		
	2SK4014	6	2.0	45	1400	—	TO-220SIS		
	2SK4115	7	2.0	45	1650	2SK2749	TO-3P(N)		
	2SK3799	8	1.3	60	2200	—	TO-220SIS		
	2SK3473	9	1.6	38	1450	—	TO-3P(N)		
	2SK3878	9	1.3	60	2200	2SK2611	TO-3P(N)		
	2SK4207	13	0.95	45	2790	—	TO-3P(N)		

■ L^2 - π -MOSV and VI Series ($V_{DSS} = 30\text{ V to }100\text{ V}$)

Part Number	V_{DSS} (V)	I_D (A)	P_D (W)	Package	$R_{DS(ON)}$ (Ω)				$R_{DS(ON)}$ (Ω)				Q_g Typ. (nC)
					Typ.	Max	V_{GS} (V)	I_D (A)	Typ.	Max	V_{GS} (V)	I_D (A)	
2SJ537	-50	-5	0.9	LSTM	0.16	0.19	-10	-2.5	0.27	0.34	-4	-1.3	18
2SJ360	-60	-1	0.5	PW-Mini	0.55	0.73	-10	-0.5	0.86	1.2	-4	-0.5	6.5
2SJ507	-60	-1	0.9	LSTM	0.5	0.7	-10	-0.5	0.72	1.0	-4	-0.5	5.6
2SJ438	-60	-5	25	TO-220NIS	0.16	0.19	-10	-2.5	0.24	0.28	-4	-2.5	22
2SJ378	-60	-5	1.2	TPS	0.16	0.19	-10	-2.5	0.24	0.28	-4	-2.5	22
2SJ349	-60	-20	45	TO-220NIS	0.033	0.045	-10	-10	0.05	0.09	-4	-10	90
2SJ401	-60	-20	100	TO-220FL/SM	0.033	0.045	-10	-10	0.05	0.09	-4	-10	90
2SJ334	-60	-30	45	TO-220NIS	0.029	0.038	-10	-15	0.046	0.06	-4	-15	110
2SJ402	-60	-30	100	TO-220FL/SM	0.029	0.038	-10	-15	0.046	0.06	-4	-15	110
2SJ508	-100	-1	1.5	PW-Mini	1.34	1.9	-10	-0.5	1.68	2.5	-4	-0.5	6.3
2SJ509	-100	-1	0.9	LSTM	1.34	1.9	-10	-0.5	1.68	2.5	-4	-0.5	6.3
2SJ380	-100	-12	35	TO-220NIS	0.15	0.21	-10	-6	0.25	0.32	-4	-6	48
2SJ412	-100	-16	60	TO-220FL/SM	0.15	0.21	-10	-6	0.25	0.32	-4	-6	48
2SJ619	-100	-16	75	TFP	0.15	0.21	-10	-6	0.25	0.32	-4	-6	48
2SJ620	-100	-18	25	TFP	0.063	0.09	-10	-9	0.085	0.12	-4	-9	140
2SJ464	-100	-18	45	TO-220NIS	0.064	0.09	-10	-9	0.085	0.12	-4	-9	140
2SK3506	30	45	100	TO-3P(N)	0.016	0.02	10	25	—	—	—	—	39
2SK2989	50	5	0.9	LSTM	0.12	0.15	10	2.5	0.24	0.33	4	1.3	6.5
2SK2614	50	20	40	DP	0.032	0.046	10	10	0.055	0.08	4	5	25
2SK2507	50	25	30	TO-220NIS	0.034	0.046	10	12	0.058	0.08	4	6	25
2SK2886	50	45	40	TO-220NIS	0.014	0.02	10	25	0.027	0.036	4	25	66
2SK3051	50	45	40	TO-220FL/SM	0.024	0.03	10	25	—	—	—	—	36
2SK2744	50	45	125	TO-3P(N)	0.015	0.02	10	25	—	—	—	—	68
2SK2550	50	45	100	TO-3P(N)	0.024	0.030	10	25	—	—	—	—	36
2SK2551	50	50	150	TO-3P(N)	0.0072	0.011	10	25	—	—	—	—	130
2SK2745	50	50	150	TO-3P(N)	0.007	0.0095	10	25	0.011	0.016	4	25	130

Part Number	V_{DS} (V)	I_D (A)	P_D (W)	Package	$R_{DS(ON)}$ (Ω)				$R_{DS(ON)}$ (Ω)				Qg Typ. (nC)
					Typ.	Max	V_{GS} (V)	I_D (A)	Typ.	Max	V_{GS} (V)	I_D (A)	
2SK2615	60	2	0.5	PW-Mini	0.23	0.3	10	1	0.33	0.44	4	1	6
2SK2961	60	2	0.9	LSTM	0.2	0.27	10	1	0.26	0.38	4	1	5.8
2SK2229	60	5	1.2	TPS	0.12	0.16	10	2.5	0.2	0.3	4	1.3	12
2SK2782	60	20	40	DP	0.039	0.055	10	10	0.06	0.090	4	5	25
2SK2232	60	25	35	TO-220NIS	0.036	0.046	10	12	0.057	0.08	4	12	38
2SK2311	60	25	40	TO-220FL/SM	0.036	0.046	10	12	0.057	0.08	4	12	38
2SK2385	60	36	40	TO-220NIS	0.022	0.03	10	18	0.04	0.055	4	15	60
2SK2233	60	45	100	TO-3P(N)	0.022	0.03	10	25	0.04	0.055	4	15	60
2SK2266	60	45	65	TO-220FL/SM	0.022	0.03	10	25	0.04	0.055	4	15	60
2SK2376	60	45	100	TO-220FL/SM	0.013	0.017	10	25	0.019	0.025	4	25	110
2SK2398	60	45	100	TO-3P(N)	0.022	0.03	10	25	—	—	—	—	60
2SK2173	60	50	125	TO-3P(N)	0.013	0.017	10	25	0.019	0.025	4	25	110
2SK2445	60	50	125	TO-3P(N)	0.014	0.018	10	25	—	—	—	—	110
2SK2267	60	60	150	TO-3P(L)	0.008	0.011	10	30	0.012	0.015	4	30	170
2SK2313	60	60	150	TO-3P(N)	0.008	0.011	10	30	0.012	0.015	4	30	170
2SK2962	100	1	0.9	LSTM	0.5	0.7	10	0.5	0.65	0.95	4	0.5	6.3
2SK2963	100	1	0.5	PW-Mini	0.5	0.7	10	0.5	0.65	0.95	4	0.5	6.3
2SK2200	100	3	1.3	TPS	0.28	0.35	10	2	0.36	0.45	4	2	13.5
2SK2201	100	3	20	New PW-Mold	0.28	0.35	10	2	0.36	0.45	4	2	13.5
2SK4018	100	3	20	New PW-Mold2	0.28	0.35	10	2	0.35	0.45	4	2	13.5
2SK2399	100	5	20	New PW-Mold	0.17	0.23	10	2.5	0.22	0.3	4	2.5	22
2SK2400	100	5	1.2	TPS	0.17	0.23	10	2.5	0.22	0.3	4	2.5	22
2SK4019	100	5	20	New PW-Mold2	0.17	0.23	10	2.5	0.22	0.3	4	2.5	22
2SK2391	100	20	35	TO-220NIS	0.068	0.085	10	10	0.09	0.13	4	10	50
2SK2314	100	27	75	TO-220AB	0.066	0.085	10	15	0.09	0.13	4	15	50
2SK2789	100	27	60	TO-220FL/SM	0.066	0.085	10	15	0.09	0.13	4	15	50
2SK3387	150	18	100	TFP	0.08	0.12	10	9	0.09	0.18	4	9	57

■ π -MOSV Series ($V_{DS} = 150$ V to 250 V)

Applications	Part Number	Absolute Maximum Ratings			Package	$R_{DS(ON)}$ (Ω)				Qg Typ. (nC)
		V_{DS} (V)	I_D (A)	P_D (W)		Typ.	Max	V_{GS} (V)	I_D (A)	
DC-DC converters Monitors Motor controllers	2SJ618	-180	-10	130	TO-3P(N)	—	0.37	-10	-5	18
	2SJ407	-200	-5	30	TO-220NIS	0.8	1.0	-10	-2.5	20
	2SJ567	-200	-2.5	20	New PW-Mold	1.6	2.0	-10	-1.5	10
	2SJ676	-200	-2.5	1.3	TPS	1.6	2.0	-10	-1.5	10
	2SJ680	-200	-2.5	20	New PW-Mold2	1.6	2.0	-10	-1.5	10
	2SJ610	-250	-2	20	PW-Mold	1.85	2.55	-10	-1.0	24
	2SJ512	-250	-5	30	TO-220NIS	1.0	1.25	-10	-2.5	22
	2SJ516	-250	-6.5	35	TO-220NIS	0.6	0.8	-10	-3	29
	2SK3670	150	0.67	0.9	LSTM	1.0	1.7	4	0.5	4.6
	2SK3205	150	5	20	PW-Mold	0.36	0.5	10	2.5	12
	2SK2882	150	18	45	TO-220NIS	0.08	0.12	10	9	57
	2SK3497	180	10	130	TO-3P(N)	—	0.15	10	5	—
	2SK2992	200	1	1.5	PW-Mini	2.2	3.5	10	0.5	3
	2SK2835	200	5	1.3	TPS	0.56	0.8	10	2.5	10
	2SK2381	200	5	25	TO-220NIS	0.56	0.8	10	2.5	10
	2SK2920	200	5	20	New PW-Mold	0.56	0.8	10	2.5	10
	2SK4020	200	5	20	New PW-Mold2	0.52	0.8	10	2.5	10
	2SK2350	200	8.5	30	TO-220NIS	0.26	0.4	10	5	17
	2SK2965	200	11	35	TO-220NIS	0.15	0.26	10	5.5	30
	2SK2382	200	15	45	TO-220NIS	0.13	0.18	10	10	40
	2SK2401	200	15	75	TO-220FL/SM	0.13	0.18	10	10	40
	2SK3625	200	25	100	TO-220FL/SM	0.065	0.082	10	12.5	44
	2SK3444	200	25	125	TFP	0.067	0.082	10	12.5	44
	2SK3176	250	30	150	TO-3P(N)	0.038	0.052	10	15	125
	2SK3462	250	3	20	New PW-Mold	1.2	1.7	10	1.5	12
	2SK4022	250	3	20	New PW-Mold2	1.2	1.7	10	1.5	12
	2SK3342	250	4.5	20	New PW-Mold	0.8	1.0	10	2.5	10
	2SK4021	250	4.5	20	New PW-Mold2	0.8	1.0	10	2.5	10
	2SK2417	250	7.5	30	TO-220NIS	0.42	0.5	10	3.5	20
	2SK2914	250	7.5	20	TO-220AB	0.42	0.5	10	3.5	20
	2SK2508	250	13	45	TO-220NIS	0.18	0.25	10	6.5	40
	2SK2598	250	13	60	TO-220FL/SM	0.18	0.25	10	6.5	40
	2SK2993	250	20	100	TO-220FL/SM	0.082	0.105	10	10	100
2SK3994	250	20	45	TO-220NIS	0.090	0.105	10	10	45	
2SK3388	250	20	125	TFP	0.082	0.105	10	10	100	
2SK3445	250	20	125	TFP	0.09	0.105	10	10	45	
2SK2967	250	30	150	TO-3P(N)	0.048	0.068	10	15	132	
2SK2995	250	30	90	TO-3P(N)IS	0.048	0.068	10	15	132	

■ π-MOSV Series (V_{DSS} = 400 V to 700 V)

Applications	Part Number	Absolute Maximum Ratings			Package	R _{DS(ON)}				Qg Typ. (nC)
		V _{DSS} (V)	I _D (A)	P _D (W)		R _{DS(ON)} (Ω)		V _{GS} (V)	I _D (A)	
						Typ.	Max			
115-Vac switching power supplies Ballast inverters Motor controllers	2SK3498	400	1	20	PW-Mold	4.2	5.5	10	0.5	5.7
	2SK2838	400	5.5	40	TO-220FL/SM	0.84	1.2	10	3	17
	2SK2679	400	5.5	35	TO-220NIS	0.84	1.2	10	3	17
	2SK2952	400	8.5	40	TO-220NIS	0.4	0.55	10	5	34
	2SK2841	400	10	80	TO-220AB	0.4	0.55	10	5	34
	2SK2949	400	10	80	TO-220FL/SM	0.4	0.55	10	5	34
	2SK3499	400	10	80	TFP	0.4	0.55	10	5	34
	2SK3472	450	1	20	New PW-Mold	4.0	4.6	10	0.5	5
	2SK3374	450	1	20	TPS	3.7	4.6	10	5	5
	2SK4023	450	1	20	New PW-Mold2	4.0	4.6	10	0.5	5
	2SK3544	450	13	100	TFP	0.29	0.4	10	6	34
	2SK2998	500	0.5	0.9	LSTM	10	18	10	0.25	3.8
	2SK3302	500	0.5	1.3	TPS	10	18	10	0.25	3.8
	2SK3471	500	0.5	0.5	PW-Mini	10	18	10	0.25	3.8
	2SK2599	500	2	1.3	TPS	2.9	3.2	10	1	9
	2SK3373	500	2	20	New PW-Mold	2.9	3.2	10	1	9
	2SK2862	500	3	25	TO-220NIS	2.9	3.2	10	1	9
	2SK2991	500	5	50	TO-220FL/SM	1.35	1.5	10	2.5	17
	2SK3466	500	5	50	TO-220FL/SM	1.35	1.5	10	2.5	17
	2SK2542	500	8	80	TO-220AB	0.75	0.85	10	4	30
	2SK2776	500	8	65	TO-220FL/SM	0.75	0.85	10	4	30
	2SK3538	500	8	65	TFP	0.75	0.85	10	4	30
	2SK2601	500	10	125	TO-3P(N)	0.56	1.0	10	5	30
	2SK3068	500	12	100	TO-220FL/SM	0.4	0.52	10	6	45
	2SK3398	500	12	100	TFP	0.4	0.52	10	6	45
	2SK2916	500	14	80	TO-3P(N)IS	0.35	0.4	10	7	58
	2SK2917	500	18	90	TO-3P(N)IS	0.21	0.27	10	10	80
	2SK3132	500	50	250	TO-3P(L)	0.07	0.095	10	25	280
	2SK3371	600	1	20	New PW-Mold	6.4	9.0	10	0.5	9
	2SK4026	600	1	20	New PW-Mold2	6.4	9	10	0.5	9
	2SK2846	600	2	1.3	TPS	4.2	5.0	10	1	9
	2SK2865	600	2	20	New PW-Mold	4.2	5.0	10	1	9
	2SK4002	600	2	20	New PW-Mold2	4.2	5	10	1	9
	2SK4003	600	3	20	New PW-Mold2	1.7	2.2	10	1.5	20
	2SK3975	600	3	20	New PW-Mold	1.7	2.2	10	1.5	20
	2SK3085	600	3.5	75	TO-220AB	1.7	2.2	10	1.8	20
	2SK3130	600	6	40	TO-220NIS	1.26	1.55	10	3	30
	2SK2777	600	6	65	TO-220FL/SM	0.9	1.25	10	3	30
	2SK2602	600	6	125	TO-3P(N)	0.9	1.25	10	3	30
	2SK3312	600	6	65	TO-220FL/SM	0.95	1.25	10	3	22
2SK3438	600	10	80	TFP	0.78	1.0	10	5	28	
2SK2889	600	10	100	TO-220FL/SM	0.54	0.75	10	5	45	
2SK2866	600	10	125	TO-220AB	0.54	0.75	10	5	45	
2SK2699	600	10	150	TO-3P(N)	0.5	0.65	10	6	58	
2SK2953	600	12	90	TO-3P(N)IS	0.31	0.4	10	8	80	
2SK3265	700	10	45	TO-220NIS	0.72	1.0	10	5	53	
2SK3453	700	10	80	TO-3P(N)IS	0.72	1.0	10	5	53	

■ π-MOSIII Series (V_{BSS} = 800 V to 1000 V)

Applications	Absolute Maximum Ratings			Package	R _{DS(ON)} (Ω)				Qg Typ. (nC)
	V _{BSS} (V)	I _D (A)	P _D (W)		Typ.	Max	V _{GS} (V)	I _D (A)	
2SK2603	800	3	100	TO-220AB	3.0	3.6	10	1.5	25
2SK2883	800	3	75	TO-220FL/SM	3.0	3.6	10	15	25
2SK2884	800	5	100	TO-220FL/SM	1.9	2.2	10	3.0	34
2SK2746	800	7	150	TO-3P(N)	1.3	1.7	10	3.5	55
2SK2606	800	8	85	TO-3P(N)IS	1.0	1.2	10	4.0	68
2SK2607	800	9	150	TO-3P(N)	1.0	1.2	10	4.0	68
2SK3301	900	1	20	PW-Mold	15	20	10	0.5	6
2SK2845	900	1	40	DP	8.0	9.0	10	0.5	15
2SK2733	900	1	60	TO-220AB	8.0	9.0	10	0.5	15
2SK2608	900	3	100	TO-220AB	3.73	4.3	10	1.5	25
2SK2719	900	3	125	TO-3P(N)	3.7	4.3	10	1.5	25
2SK2847	900	8	85	TO-3P(N)IS	1.05	1.25	10	4.0	58
2SK3017	900	8.5	90	TO-3P(N)IS	1.2	1.4	10	4.0	70
2SK2968	900	10	150	TO-3P(N)	1.05	1.25	10	4	70
2SK2613	1000	8	150	TO-3P(N)	1.4	1.7	10	8.0	65

7-1 Alphanumeric Index of Part Numbers

Part Number	Series	Package	Main Characteristics			Page
			V _{DSS} (V)	I _D (A)	R _{DS(ON)} Max (Ω)	
2SJ168	π -MOSIII	S-MINI	-60	-0.2	2	36
2SJ200	π -MOSII	TO-3P (N)	-180	-10	0.83	-
2SJ201	π -MOSII	TO-3P (L)	-200	-12	0.63	-
2SJ304	L ² - π -MOSIV	TO-220NIS	-60	-14	0.12	-
2SJ305	π -MOSIII	S-MINI	-30	-0.2	4	36
2SJ312	L ² - π -MOSIV	TO-220FL/SM	-60	-14	0.12	-
2SJ313	π -MOSII	TO-220NIS	-180	-1	5	-
2SJ334	L ² - π -MOSV	TO-220NIS	-60	-30	0.038	43
2SJ338	π -MOSII	PW-Mold	-180	-1	5	-
2SJ343	π -MOSIII	S-MINI	-50	-0.05	50	36
2SJ344	π -MOSIII	USM	-50	-0.05	50	36
2SJ349	L ² - π -MOSV	TO-220NIS	-60	-20	0.045	43
2SJ360	L ² - π -MOSV	PW-Mini	-60	-1	0.73	43
2SJ378	L ² - π -MOSV	TPS	-60	-5	0.19	43
2SJ380	L ² - π -MOSV	TO-220NIS	-100	-12	0.21	43
2SJ401	L ² - π -MOSV	TO-220FL/SM	-60	-20	0.045	43
2SJ402	L ² - π -MOSV	TO-220FL/SM	-60	-30	0.038	43
2SJ407	π -MOSV	TO-220NIS	-200	-5	1	44
2SJ412	L ² - π -MOSV	TO-220FL/SM	-100	-16	0.21	43
2SJ438	L ² - π -MOSV	TO-220NIS	-60	-5	0.19	43
2SJ440	π -MOSII	TO-3P (N)IS	-180	-9	0.8	-
2SJ464	L ² - π -MOSV	TO-220NIS	-100	-18	0.09	43
2SJ507	L ² - π -MOSV	LSTM	-60	-1	0.7	43
2SJ508	L ² - π -MOSV	PW-Mini	-100	-1	1.9	43
2SJ509	L ² - π -MOSV	LSTM	-100	-1	1.9	43
2SJ512	π -MOSV	TO-220NIS	-250	-5	1.25	44
2SJ516	π -MOSV	TO-220NIS	-250	-6.5	0.8	44
2SJ537	L ² - π -MOSV	LSTM	-50	-5	0.19	43
2SJ567	π -MOSV	New PW-Mold	-200	-2.5	2	44
2SJ610	π -MOSV	PW-Mold	-250	-2	2.55	44
2SJ618	π -MOSV	TO-3P (N)	-180	-10	0.37	44
2SJ619	L ² - π -MOSV	TFP	-100	-16	0.21	43
2SJ620	L ² - π -MOSV	TFP	-100	-18	0.09	43
2SJ668	U-MOSIII	New PW-Mold	-60	-5	0.17	38
2SJ669	U-MOSIII	TPS	-60	-5	0.17	38
2SJ676	π -MOSV	TPS	-200	-2.5	2	44
2SJ680	π -MOSV	New PW-Mold2	-200	-2.5	2	44
2SJ681	U-MOSIII	New PW-Mold2	-60	-5	0.17	38
2SK1062	π -MOSIII	S-MINI	60	0.2	1	36
2SK1119	π -MOSII.5	TO-220AB	1000	4	3.8	-
2SK1359	π -MOSII.5	TO-3P (N)	100	5	3.8	-
2SK1365	π -MOSII.5	TO-3P (N)IS	1000	7	1.8	-
2SK1381	L ² - π -MOSIII	TO-3P (N)	100	50	0.032	-
2SK1382	L ² - π -MOSIII	TO-3P (L)	100	60	0.02	-
2SK1486	π -MOSIII.5	TO-3P (L)	300	32	0.095	-
2SK1489	π -MOSIII.5	TO-3P (L)	1000	12	1	-
2SK1529	π -MOSII	TO-3P (N)	180	10	0.83	-
2SK1530	π -MOSII	TO-3P (N)	200	12	0.63	-
2SK1544	π -MOSIII.5	TO-3P (L)	500	25	0.2	-
2SK1930	π -MOSII.5	TO-220FL/SM	1000	4	3.8	-
2SK2009	π -MOSIII	S-MINI	30	0.2	2	36
2SK2013	π -MOSII	TO-220NIS	180	1	5	-

Part Number	Series	Package	Main Characteristics			Page
			V _{DSS} (V)	I _D (A)	R _{DS(ON)} Max (Ω)	
2SK2162	π -MOSII	PW-Mold	180	1	5	-
2SK2173	L ² - π -MOSV	TO-3P (N)	60	50	0.017	44
2SK2200	L ² - π -MOSV	TPS	100	3	0.35	44
2SK2201	L ² - π -MOSV	New PW-Mold	100	3	0.35	44
2SK2229	L ² - π -MOSV	TPS	60	5	0.16	44
2SK2232	L ² - π -MOSV	TO-220NIS	60	25	0.046	44
2SK2233	L ² - π -MOSV	TO-3P (N)	60	45	0.03	44
2SK2266	L ² - π -MOSV	TO-220FL/SM	60	45	0.03	44
2SK2267	L ² - π -MOSV	TO-3P (L)	60	60	0.011	44
2SK2274	π -MOSII.5	TO-220NIS	700	5	1.7	-
2SK2311	L ² - π -MOSV	TO-220FL/SM	60	25	0.046	44
2SK2313	L ² - π -MOSV	TO-3P (N)	60	60	0.011	44
2SK2314	L ² - π -MOSV	TO-220AB	100	27	0.085	44
2SK2350	π -MOSV	TO-220NIS	200	8.5	0.4	44
2SK2376	L ² - π -MOSV	TO-220FL/SM	60	45	0.017	44
2SK2381	π -MOSV	TO-220NIS	200	5	0.8	44
2SK2382	π -MOSV	TO-220NIS	200	15	0.18	44
2SK2385	L ² - π -MOSV	TO-220NIS	60	36	0.03	44
2SK2391	L ² - π -MOSV	TO-220NIS	100	20	0.085	44
2SK2398	L ² - π -MOSV	TO-3P (N)	60	45	0.03	44
2SK2399	L ² - π -MOSV	New PW-Mold	100	5	0.23	44
2SK2400	L ² - π -MOSV	TPS	100	5	0.23	44
2SK2401	π -MOSV	TO-220FL/SM	200	15	0.18	44
2SK2417	π -MOSV	TO-220NIS	250	7.5	0.5	44
2SK2445	L ² - π -MOSV	TO-3P (N)	60	50	0.018	44
2SK2467	π -MOSII	TO-3P (N)IS	180	9	0.8	-
2SK2507	L ² - π -MOSV	TO-220NIS	50	25	0.046	43
2SK2508	π -MOSV	TO-220NIS	250	13	0.25	44
2SK2542	π -MOSV	TO-220AB	500	8	0.85	45
2SK2550	L ² - π -MOSV	TO-3P (N)	50	45	0.03	43
2SK2551	L ² - π -MOSV	TO-3P (N)	50	50	0.011	43
2SK2598	π -MOSV	TO-220FL/SM	250	13	0.25	44
2SK2599	π -MOSV	TPS	500	2	3.2	45
2SK2601	π -MOSV	TO-3P (N)	500	10	1	45
2SK2602	π -MOSV	TO-3P (N)	600	6	1.25	45
2SK2603	π -MOSIII	TO-220AB	800	3	3.6	45
2SK2606	π -MOSIII	TO-3P (N)IS	800	8	1.2	45
2SK2607	π -MOSIII	TO-3P (N)	800	9	1.2	45
2SK2608	π -MOSIII	TO-220AB	900	3	4.3	45
2SK2613	π -MOSIII	TO-3P (N)	1000	8	1.7	45
2SK2614	L ² - π -MOSV	DP	50	20	0.046	43
2SK2615	L ² - π -MOSV	PW-Mini	60	2	0.3	44
2SK2679	π -MOSV	TO-220NIS	400	5.5	1.2	45
2SK2699	π -MOSV	TO-3P (N)	600	12	0.65	45
2SK2719	π -MOSIII	TO-3P (N)	900	3	4.3	45
2SK2733	π -MOSIII	TO-220AB	900	1	9	45
2SK2744	L ² - π -MOSV	TO-3P (N)	50	45	0.02	43
2SK2745	L ² - π -MOSV	TO-3P (N)	50	50	0.0095	43
2SK2776	π -MOSV	TO-220FL/SM	500	8	0.85	45
2SK2777	π -MOSV	TO-220FL/SM	600	6	1.25	45
2SK2782	L ² - π -MOSV	DP	60	20	0.055	44
2SK2789	L ² - π -MOSV	TO-220FL/SM	100	27	0.085	44

Part Number	Series	Package	Main Characteristics			Page
			V _{BSS} (V)	I _D (A)	R _{DS(ON)} Max (Ω)	
2SK2835	π-MOSV	TPS	200	5	0.8	44
2SK2838	π-MOSV	TO-220FL/SM	400	5.5	1.2	45
2SK2841	π-MOSV	TO-220AB	400	10	0.55	45
2SK2845	π-MOSIII	DP	900	1	9	45
2SK2846	π-MOSV	TPS	600	2	5	45
2SK2847	π-MOSIII	TO-3P (N)IS	900	8	1.4	45
2SK2862	π-MOSV	TO-220NIS	500	3	3.2	45
2SK2865	π-MOSV	New PW-Mold	600	2	5	45
2SK2866	π-MOSV	TO-220AB	600	10	0.75	42,45
2SK2882	π-MOSV	TO-220NIS	150	18	0.12	44
2SK2883	π-MOSIII	TO-220FL/SM	800	3	3.6	45
2SK2884	π-MOSIII	TO-220FL/SM	800	5	2.2	45
2SK2886	L ² -π-MOSV	TO-220NIS	50	45	0.02	43
2SK2889	π-MOSV	TO-220FL/SM	600	10	0.75	45
2SK2914	π-MOSV	TO-220AB	250	7.5	0.5	44
2SK2916	π-MOSV	TO-3P (N)IS	500	14	0.4	45
2SK2917	π-MOSV	TO-3P (N)IS	500	18	0.27	45
2SK2920	π-MOSV	New PW-Mold	200	5	0.8	44
2SK2949	π-MOSV	TO-220FL/SM	400	10	0.55	45
2SK2952	π-MOSV	TO-220NIS	400	8.5	0.55	45
2SK2953	π-MOSV	TO-3P (N)IS	600	15	0.4	45
2SK2961	L ² -π-MOSV	LSTM	60	2	0.27	44
2SK2962	L ² -π-MOSV	LSTM	100	1	0.7	44
2SK2963	L ² -π-MOSV	PW-Mini	100	1	0.7	44
2SK2965	π-MOSV	TO-220NIS	200	11	0.26	44
2SK2967	π-MOSV	TO-3P (N)	250	30	0.068	44
2SK2968	π-MOSIII	TO-3P (N)	900	10	1.25	45
2SK2989	L ² -π-MOSV	LSTM	50	5	0.15	43
2SK2991	π-MOSV	TO-220FL/SM	500	5	1.5	42,45
2SK2992	π-MOSV	PW-Mini	200	1	3.5	44
2SK2993	π-MOSV	TO-220FL/SM	250	20	0.105	44
2SK2995	π-MOSV	TO-3P (N)IS	250	30	0.068	44
2SK2998	π-MOSV	LSTM	500	0.5	18	45
2SK3017	π-MOSIII	TO-3P (N)IS	900	8.5	1.25	45
2SK3051	L ² -π-MOSV	TO-220FL/SM	50	45	0.03	43
2SK3068	π-MOSV	TO-220FL/SM	500	12	0.52	45
2SK3085	π-MOSV	TO-220AB	600	3.5	2.2	45
2SK3130	π-MOSV	TO-220NIS	600	6	1.55	45
2SK3131	π-MOSV(HSD)	TO-3P (L)	500	50	0.11	42
2SK3132	π-MOSV	TO-3P (L)	500	50	0.095	42,45
2SK3176	π-MOSV	TO-3P (N)	200	30	0.052	44
2SK3205	π-MOSV	PW-Mold	150	5	0.5	44
2SK3265	π-MOSV	TO-220NIS	700	10	1	45
2SK3301	π-MOSIII	PW-Mold	900	1	20	45
2SK3302	π-MOSV	TPS	500	0.5	18	45
2SK3309	MACH	TO-220FL/SM	450	10	0.65	42
2SK3310	MACH	TO-220NIS	450	10	0.65	42
2SK3312	π-MOSV	TO-220FL/SM	600	6	1.25	42,45
2SK3313	π-MOSV(HSD)	TO-220NIS	500	12	0.62	42
2SK3314	π-MOSV(HSD)	TO-3P (N)	500	15	0.49	42
2SK3342	π-MOSV	New PW-Mold	250	4.5	1	44
2SK3371	π-MOSV	New PW-Mold	600	1	9	45
2SK3373	π-MOSV	New PW-Mold	500	2	3.2	45
2SK3374	π-MOSV	TPS	450	1	4.6	45
2SK3387	L ² -π-MOSV	TFP	150	18	0.12	44

Part Number	Series	Package	Main Characteristics			Page
			V _{BSS} (V)	I _D (A)	R _{DS(ON)} Max (Ω)	
2SK3388	π-MOSV	TFP	250	20	0.105	44
2SK3398	π-MOSV	TFP	500	12	0.52	45
2SK3399	MACH	TO-220FL/SM	600	10	0.75	42
2SK3403	MACH	TO-220FL/SM	450	13	0.4	42
2SK3417	π-MOSV(HSD)	TO-220FL/SM	500	5	1.8	42
2SK3437	MACH	TO-220FL/SM	600	10	1	42
2SK3438	π-MOSV	TFP	600	10	1	45
2SK3444	π-MOSV	TFP	200	25	0.082	44
2SK3445	π-MOSV	TFP	250	20	0.105	44
2SK3453	π-MOSIV	TO-3P (N)IS	700	10	1	45
2SK3462	π-MOSV	New PW-Mold	250	3	1.7	44
2SK3466	π-MOSV	TFP	500	5	1.5	45
2SK3471	π-MOSV	PW-Mini	500	0.5	18	45
2SK3472	π-MOSV	PW-Mold	450	1	4.6	45
2SK3473	π-MOSIV	TO-3P (N)	900	9	1.6	43
2SK3497	π-MOSV	TO-3P (N)	180	10	0.15	44
2SK3498	π-MOSV	PW-Mold	400	1	5.5	45
2SK3499	π-MOSV	TFP	400	10	0.55	45
2SK3506	π-MOSVI	TO-3P (N)	30	45	0.02	43
2SK3538	π-MOSV	TFP	500	8	0.85	45
2SK3544	π-MOSV	TFP	450	13	0.4	45
2SK3561	π-MOSVI	TO-220SIS	500	8	0.85	40,42,43
2SK3562	π-MOSVI	TO-220SIS	600	6	1.25	40,42,43
2SK3563	π-MOSVI	TO-220SIS	500	5	1.5	40,42,43
2SK3564	π-MOSIV	TO-220SIS	900	3	4.3	43
2SK3565	π-MOSIV	TO-220SIS	900	5	2.5	43
2SK3566	π-MOSIV	TO-220SIS	900	2.5	6.4	43
2SK3567	π-MOSVI	TO-220SIS	600	3.5	2.2	40,43
2SK3568	π-MOSVI	TO-220SIS	500	12	0.52	40,43
2SK3569	π-MOSVI	TO-220SIS	600	10	0.75	40,42,43
2SK3625	π-MOSV	TO-220FL/SM	200	25	0.082	44
2SK3633	π-MOSIV	TO-3P (N)	800	7	1.7	43
2SK3662	U-MOSIII	TO-220NIS	60	35	0.0125	38
2SK3667	π-MOSVI	TO-220SIS	600	7.5	1	40,43
2SK3669	π-MOSVII	New PW-Mold	100	10	0.125	-
2SK3670	π-MOSV	LSTM	150	0.67	1.7	44
2SK3700	π-MOSIV	TO-3P (N)	900	5	2.5	43
2SK3742	π-MOSIV	TO-220SIS	900	5	2.5	43
2SK3743	MACH	TO-220NIS	450	13	0.6	40,42
2SK3754	U-MOSIII	TO-220NIS	30	5	0.089	38
2SK3757	π-MOSVI	TO-220SIS	450	2	2.45	43
2SK3766	π-MOSVI	TO-220SIS	450	2	2.45	43
2SK3767	π-MOSVI	TO-220SIS	600	2	4.5	43
2SK3797	π-MOSVI	TO-220SIS	600	13	0.43	40,42,43
2SK3798	π-MOSIV	TO-220SIS	900	4	3.5	43
2SK3799	π-MOSIV	TO-220SIS	900	8	1.3	43
2SK3842	U-MOSIII	TFP	60	75	0.0058	38
2SK3843	U-MOSIII	TFP	40	75	0.0035	38
2SK3844	U-MOSIII	TO-220NIS	60	45	0.0058	38
2SK3845	U-MOSIII	TO-3P (N)	60	70	0.0058	38
2SK3846	U-MOSIII	TO-220NIS	40	26	0.018	38
2SK3847	U-MOSIII	TO-220SM	40	32	0.016	38
2SK3863	π-MOSVI	DP	500	5	1.5	43
2SK3868	π-MOSVI (HSD)	TO-220SIS	500	5	1.7	42
2SK3869	π-MOSVI	TO-220SIS	450	10	0.68	43

Part Number	Series	Package	Main Characteristics			Page
			V _{bss} (V)	I _D (A)	R _{DS(ON)} Max (Ω)	
2SK3878	π -MOSIV	TO-3P (N)	900	9	1.3	43
2SK3879	π -MOSIV	TO-220FL/SM	800	6.5	1.7	43
2SK3880	π -MOSIV	TO-3P (N)IS	800	6.5	1.7	43
2SK3903	π -MOSVI	TO-3P (N)	600	14	0.44	43
2SK3904	π -MOSVI	TO-3P (N)	450	19	0.26	43
2SK3905	π -MOSVI	TO-3P (N)	500	17	0.31	43
2SK3906	MACH (HSD)	TO-3P (N)	600	20	0.33	42
2SK3907	MACH	TO-3P (N)	500	23	0.23	42
2SK3911	MACH	TO-3P (N)	600	20	0.32	41,42
2SK3934	π -MOSVI	TO-220SIS	500	15	0.3	40,43
2SK3935	π -MOSVI	TO-220SIS	450	17	0.25	43
2SK3936	MACH (HSD)	TO-3P (N)	500	23	0.25	42
2SK3947	π -MOSVI (HSD)	TO-220SIS	600	6	1.4	42
2SK3975	π -MOSV	New PW-Mold	600	3	2.2	45
2SK3994	π -MOSV	TO-220NIS	250	20	0.105	44
2SK4002	π -MOSV	New PW-Mold2	600	2	5	40,45
2SK4003	π -MOSV	New PW-Mold2	600	3	2.2	45
2SK4012	π -MOSVI	TO-220SIS	500	13	0.4	40,43
2SK4013	π -MOSIV	TO-220SIS	800	6	1.7	43
2SK4014	π -MOSIV	TO-220SIS	900	6	2	43
2SK4015	π -MOSVI (HSD)	TO-220SIS	600	10	0.86	42
2SK4016	π -MOSVI (HSD)	TO-220SIS	600	13	0.5	42
2SK4017	U-MOSIII	New PW-Mold2	60	5	0.1	38
2SK4018	L ² - π -MOSV	New PW-Mold2	100	3	0.35	44
2SK4019	L ² - π -MOSV	New PW-Mold2	100	5	0.23	44
2SK4020	π -MOSV	New PW-Mold2	200	5	0.8	44
2SK4021	π -MOSV	New PW-Mold2	250	4.5	1	44
2SK4022	π -MOSV	New PW-Mold2	250	3	1.7	44
2SK4023	π -MOSV	New PW-Mold2	450	1	4.6	45
2SK4026	π -MOSV	New PW-Mold2	600	1	9	45
2SK4033	U-MOSIII	New PW-Mold	60	5	0.1	38
2SK4034	U-MOSIII	TFP	60	75	0.0058	38
2SK4042	π -MOSVI (HSD)	TO-220SIS	500	8	0.97	42
2SK4103	π -MOSVI	New PW-Mold	500	5	1.5	43
2SK4107	π -MOSVI	TO-3P (N)	500	15	0.4	40,43
2SK4108	π -MOSVI	TO-3P (N)	500	20	0.27	40,43
2SK4115	π -MOSIV	TO-3P (N)	900	7	2	43
2SK4207	π -MOSIV	TO-3P (N)	900	13	0.95	43
S3U72	U-MOSV-H	SOP Advance	30	TBD	TBD	35
S3W16	U-MOSIV-H	SOP Advance	30	(40)	(0.0035)	-
SSM3J01T	π -MOSVI	TSM	-30	-1.7	0.4	28
SSM3J02T	π -MOSVI	TSM	-30	-1.5	0.5	28
SSM3J05FU	π -MOSVI	USM	-20	-0.2	4	36
SSM3J09FU	π -MOSVI	USM	-30	-0.2	4.2	36
SSM3J108TU	U-MOSIII	UFM	-20	-1.8	0.158	28
SSM3J109TU	U-MOSII	UFM	-20	-2	0.13	28
SSM3J110TU	U-MOSIII	UFM	-12	-2.3	0.094	28
SSM3J111TU	U-MOSIII	UFM	-20	-1	0.48	28
SSM3J112TU	U-MOSII	UFM	-30	-1.1	0.79	28
SSM3J113TU	U-MOSIII	UFM	-20	-1.7	0.169	28
SSM3J114TU	U-MOSIV	UFM	-20	-1.8	0.149	28
SSM3J115TU	U-MOSIV	UFM	-20	-2.2	0.098	28
SSM3J117TU	U-MOSII	UFM	-30	-2	0.225	28
SSM3J118TU	U-MOSII	UFM	-30	-1.4	0.48	28
SSM3J120TU	U-MOSIV	UFM	-20	-4	0.038	28

Part Number	Series	Package	Main Characteristics			Page
			V _{bss} (V)	I _D (A)	R _{DS(ON)} Max (Ω)	
SSM3J129TU	U-MOSV	UFM	-20	-4.6	0.046	28
SSM3J130TU	U-MOSVI	UFM	-20	-4.4	0.0258	28
SSM3J132TU	U-MOSVI	UFM	-12	-5	0.0178	28
SSM3J13T	U-MOSIII	TSM	-12	-3	0.07	28
SSM3J14T	U-MOSII	TSM	-30	-2.7	0.17	28
SSM3J15CT	π -MOSVI	CST3	-30	-0.1	32	36
SSM3J15F	π -MOSVI	S-MINI	-30	-0.1	32	36
SSM3J15FS	π -MOSVI	SSM	-30	-0.1	32	36
SSM3J15FU	π -MOSVI	USM	-30	-0.1	32	36
SSM3J15FV	π -MOSVI	VESM	-30	-0.1	32	36
SSM3J16CT	π -MOSVI	CST3	-20	-0.1	45	36
SSM3J16FS	π -MOSVI	SSM	-20	-0.1	45	36
SSM3J16FU	π -MOSVI	USM	-20	-0.1	45	36
SSM3J16FV	π -MOSVI	VESM	-20	-0.1	45	48
SSM3J304T	U-MOSIII	TSM	-20	-2.3	0.127	28
SSM3J305T	U-MOSII	TSM	-30	-1.7	0.477	28
SSM3J306T	U-MOSII	TSM	-30	-2.4	0.225	28
SSM3J307T	U-MOSV	TSM	-20	-5.0	0.031	28
SSM3J312T	U-MOSIII	TSM	-12	-2.7	0.091	28
SSM3J313T	U-MOSIII	TSM	-20	-1.6	0.268	28
SSM3J314T	U-MOSIII-H	TSM	-30	-3.5	0.1	28
SSM3J317T	U-MOSIII	TSM	-20	-3.6	0.107	28
SSM3J321T	U-MOSV	TSM	-20	-5.2	0.046	28
SSM3J325F	U-MOSVI	S-MINI	-20	-2.0	0.155	28
SSM3J326T	U-MOSVI	TSM	-30	-5.6	0.0457	28
SSM3J327F	U-MOSVI	S-MINI	-20	-3.5	0.095	28
SSM3J35CT	π -MOSVI	CST3	-20	-0.1	44	36
SSM3J35FS	π -MOSVI	SSM	-20	-0.1	44	36
SSM3J35MFV	π -MOSVI	VESM	-20	-0.1	44	36
SSM3J36FS	U-MOSIII	SSM	-20	-0.33	3.6	36
SSM3J36MFV	U-MOSIII	VESM	-20	-0.33	3.6	36
SSM3J36TU	U-MOSIII	UFM	-20	-0.33	3.6	36
SSM3J46CTB	U-MOSVI	CST3B	-20	-2	0.103	28
SSM3K01T	π -MOSVI	TSM	30	3.2	0.12	29
SSM3K02T	π -MOSVI	TSM	30	2.5	0.2	29
SSM3K03FV	π -MOSVI	VESM	20	0.1	12	36
SSM3K04FS	π -MOSVI	SSM	20	0.1	12	36
SSM3K04FU	π -MOSVI	USM	20	0.1	12	36
SSM3K04FV	π -MOSVI	VESM	20	0.1	12	36
SSM3K05FU	π -MOSVI	USM	20	0.4	1.2	36
SSM3K09FU	π -MOSVI	USM	30	0.4	1.2	36
SSM3K101TU	U-MOSIII	UFM	20	2.2	0.103	29
SSM3K102TU	U-MOSIII	UFM	20	2.6	0.071	29
SSM3K104TU	U-MOSIII	UFM	20	3	0.056	29
SSM3K105TU	π -MOSVI	UFM	30	2.1	0.2	29
SSM3K106TU	π -MOSVII	UFM	20	1.2	0.53	29
SSM3K107TU	π -MOSVI	UFM	20	1.5	0.41	29
SSM3K116TU	U-MOSIII	UFM	30	2.2	0.1	29
SSM3K119TU	U-MOSIII	UFM	30	2.5	0.074	29
SSM3K121TU	U-MOSIII	UFM	20	3.2	0.048	29
SSM3K122TU	U-MOSIII	UFM	20	2	0.123	29
SSM3K123TU	U-MOSIII	UFM	20	4.2	0.028	29
SSM3K124TU	π -MOSVII	UFM	30	2.4	0.12	29
SSM3K127TU	U-MOSIII	UFM	30	2	0.123	29
SSM3K128TU	U-MOSIII	UFM	30	1.5	0.36	29

Part Number	Series	Package	Main Characteristics			Page
			V _{BSS} (V)	I _D (A)	R _{DS(ON)} Max (Ω)	
SSM3K12T	π -MOSVII	TSM	30	3	0.175	29
SSM3K131TU	U-MOSIV	UFM	30	6.0	0.0415	29
SSM3K14T	U-MOSII	TSM	30	4	0.067	29
SSM3K15CT	π -MOSVI	CST3	30	0.1	7	36
SSM3K15F	π -MOSVI	S-MINI	30	0.1	7	36
SSM3K15FS	π -MOSVI	SSM	30	0.1	7	36
SSM3K15FU	π -MOSVI	USM	30	0.1	7	36
SSM3K15FV	π -MOSVI	VESM	30	0.1	7	36
SSM3K16CT	π -MOSVI	CST3	20	0.1	15	36
SSM3K16FS	π -MOSVI	SSM	20	0.1	15	36
SSM3K16FU	π -MOSVI	USM	20	0.1	15	36
SSM3K16FV	π -MOSVI	VESM	20	0.1	15	36
SSM3K17FU	π -MOSV	USM	50	0.1	40	36
SSM3K301T	U-MOSIII	TSM	20	3.5	0.056	29
SSM3K303T	π -MOSVII	TSM	30	2.9	0.12	29
SSM3K309T	U-MOSIII	TSM	20	4.7	0.031	29
SSM3K310T	U-MOSIII	TSM	20	5	0.028	29
SSM3K315T	U-MOSIV	TSM	30	6	0.0415	29
SSM3K316T	U-MOSIII	TSM	30	4	0.065	29
SSM3K318T	U-MOSIV	TSM	60	2.5	0.145	29
SSM3K320T	U-MOSIV	TSM	30	4.2	0.077	29
SSM3K35CT	π -MOSVI	CST3	20	0.18	20	36
SSM3K35FS	π -MOSVI	SSM	20	0.18	20	36
SSM3K35MFV	π -MOSVI	VESM	20	0.18	20	36
SSM3K36FS	U-MOSIII	SSM	20	0.5	1.52	36
SSM3K36MFV	U-MOSIII	VESM	20	0.5	1.52	36
SSM3K36TU	U-MOSIII	UFM	20	0.5	1.52	36
SSM3K43FS	U-MOSIII	SSM	20	0.5	1.52	36
SSM3K44FS	π -MOSVI	SSM	30	0.1	7	36
SSM3K44MFV	π -MOSVI	VESM	30	0.1	7	36
SSM3K7002AF	π -MOSV	S-MINI	60	0.2	3.3	36
SSM3K7002AFU	π -MOSV	USM	60	0.2	3.3	36
SSM3K7002BF	U-MOSIV	S-MINI	60	0.2	3.3	36
SSM3K7002BFS	U-MOSIV	SSM	60	0.2	3.3	36
SSM3K7002BFU	U-MOSIV	USM	60	0.2	3.3	36
SSM3K7002F	π -MOSVI	S-MINI	60	0.2	3.3	36
SSM3K7002FU	π -MOSVI	USM	60	0.2	3.3	36
SSM4K27CT	U-MOSIII	CST4	20	0.5	0.205	29
SSM5G01TU	U-MOSII	UFV	-30	-1	0.8	30
SSM5G02TU	U-MOSII	UFV	-12	-1	0.16	30
SSM5G04TU	U-MOSII	UFV	-12	-1	0.24	30
SSM5G09TU	U-MOSII	UFV	-12	-1.5	0.13	30
SSM5G10TU	U-MOSIII	UFV	-20	-1.5	0.213	30
SSM5G11TU	U-MOSIII-H	UFV	-30	-1.4	0.403	30
SSM5H01TU	U-MOSII	UFV	30	1.4	0.45	30
SSM5H03TU	U-MOSII	UFV	12	1.4	0.3	30
SSM5H05TU	U-MOSIII	UFV	20	1.5	0.16	30
SSM5H07TU	π -MOSVII	UFV	20	1.2	0.54	30
SSM5H08TU	U-MOSIII	UFV	20	1.5	0.16	30
SSM5H10TU	U-MOSIII	UFV	20	1.6	0.119	30
SSM5H11TU	U-MOSIII	UFV	30	1.6	0.182	30
SSM5H12TU	U-MOSIII	UFV	30	1.9	0.133	30
SSM5H14F	U-MOSIII	SMV	30	3	0.078	31
SSM5N03FE	π -MOSVI	ES6	20	0.1	12	36
SSM5N05FU	π -MOSVI	US6	20	0.4	1.2	36

Part Number	Series	Package	Main Characteristics			Page
			V _{BSS} (V)	I _D (A)	R _{DS(ON)} Max (Ω)	
SSM5N15FE	π -MOSVI	ES6	30	0.1	7	36
SSM5N15FU	π -MOSVI	US6	30	0.1	7	36
SSM5N16FE	π -MOSVI	ES6	20	0.1	15	36
SSM5N16FU	π -MOSVI	US6	20	0.1	15	36
SSM5P05FU	π -MOSVI	US6	-20	-0.2	4	36
SSM5P15FE	π -MOSVI	ES6	-30	-0.1	32	36
SSM5P15FU	π -MOSVI	US6	-30	-0.1	32	36
SSM5P16FE	π -MOSVI	ES6	-20	-0.1	45	36
SSM5P16FU	π -MOSVI	US6	-20	-0.1	45	36
SSM6E01TU	U-MOSIII	UF6	-12	-1	0.16	30
SSM6E02TU	U-MOSIV	UF6	-20	-1.8	0.136	30
SSM6E03TU	U-MOSIII	UF6	-20	-1.8	0.144	30
SSM6J06FU	π -MOSVI	US6	-20	-0.65	0.5	28
SSM6J07FU	π -MOSVI	US6	-30	-0.8	0.8	28
SSM6J08FU	U-MOSII	US6	-20	-1.3	0.18	28
SSM6J205FE	U-MOSIII	ES6	-20	-0.8	0.234	28
SSM6J206FE	U-MOSIII	ES6	-20	-2	0.13	28
SSM6J207FE	U-MOSII	ES6	-30	-1.3	0.491	28
SSM6J21TU	U-MOSIII	UF6	-12	-3	0.05	28
SSM6J212FE	U-MOSVI	ES6	-20	-3.3	0.0434	28
SSM6J23FE	U-MOSIII	ES6	-12	-1.2	0.16	28
SSM6J25FE	U-MOSIII	ES6	-20	-0.5	0.26	28
SSM6J26FE	U-MOSIII	ES6	-20	-0.5	0.23	28
SSM6J401TU	U-MOSIII	UF6	-30	-2.5	0.145	28
SSM6J402TU	U-MOSIII	UF6	-30	-2	0.225	28
SSM6J409TU	U-MOSV	UF6	-20	-9.5	0.0221	28
SSM6J50TU	U-MOSIV	UF6	-20	-2.5	0.064	28
SSM6J51TU	U-MOSIV	UF6	-12	-4	0.054	28
SSM6J53FE	U-MOSIV	ES6	-20	-1.8	0.136	28
SSM6K06FU	π -MOSVI	US6	20	1.1	0.16	29
SSM6K07FU	π -MOSVI	US6	30	1.5	0.22	29
SSM6K08FU	U-MOSII	US6	20	1.6	0.105	29
SSM6K18TU	U-MOSIII	UF6	20	4	0.04	29
SSM6K202FE	U-MOSIII	ES6	30	2.3	0.085	29
SSM6K203FE	U-MOSIII	ES6	20	2.8	0.061	29
SSM6K204FE	U-MOSIII	ES6	20	2	0.126	29
SSM6K208FE	U-MOSIII	ES6	30	1.9	0.133	29
SSM6K210FE	U-MOSIII	ES6	30	1.4	0.371	29
SSM6K211FE	U-MOSIII	ES6	20	3.2	0.047	29
SSM6K22FE	U-MOSIII	ES6	20	1.4	0.17	29
SSM6K24FE	U-MOSIII	ES6	30	0.5	0.145	29
SSM6K25FE	U-MOSIII	ES6	20	0.5	0.145	29
SSM6K30FE	π -MOSVII	ES6	20	1.2	0.42	29
SSM6K31FE	π -MOSVII	ES6	20	1.2	0.54	29
SSM6K32TU	π -MOSV	UF6	60	2	0.44	29
SSM6K34TU	U-MOSIII	UF6	30	3	0.077	29
SSM6K403TU	U-MOSIII	UF6	20	4.2	0.028	29
SSM6K404TU	U-MOSIII	UF6	20	3	0.055	29
SSM6K405TU	U-MOSIII	UF6	20	2	0.126	29
SSM6K406TU	U-MOSIV	UF6	30	4.4	0.0385	29
SSM6K407TU	π -MOSV	UF6	60	2	0.44	29
SSM6L05FU	π -MOSVI	US6	20	0.4	1.2	36
SSM6L09FU	π -MOSVI	US6	30	0.4	1.2	36
SSM6L10TU	U-MOSIII	UF6	20	0.5	0.145	30
SSM6L11TU	U-MOSIII	UF6	20	0.5	0.145	30

Part Number	Series	Package	Main Characteristics			Page
			V _{DSS} (V)	I _D (A)	R _{DS(ON)} Max (Ω)	
SSM6L12TU	U-MOSIII	UF6	30	0.5	0.145	30
SSM6L13TU	U-MOSIII	UF6	20	0.8	0.143	30
SSM6L16FE	π -MOSVI	ES6	20	0.1	15	36
SSM6L35FE	π -MOSVI	ES6	20	0.18	20	36
SSM6L35FU	π -MOSVI	US6	20	0.18	20	36
SSM6L36FE	U-MOSIII	ES6	20	0.5	1.52	36
SSM6L36TU	U-MOSIII	UF6	20	0.5	1.52	36
SSM6L39TU	U-MOSIII	UF6	20	1.6	0.119	30
SSM6L40TU	U-MOSIII	UF6	30	1.6	0.182	30
SSM6N03FE	π -MOSVI	ES6	20	0.1	12	36
SSM6N04FU	π -MOSVI	US6	20	0.1	12	36
SSM6N05FU	π -MOSVI	US6	20	0.4	1.2	36
SSM6N09FU	π -MOSVI	US6	30	0.4	1.2	36
SSM6N15FE	π -MOSVI	ES6	30	0.1	7	36
SSM6N15FU	π -MOSVI	US6	30	0.1	7	36
SSM6N16FE	π -MOSVI	ES6	20	0.1	15	36
SSM6N16FU	π -MOSVI	US6	20	0.1	15	36
SSM6N17FU	π -MOSV	US6	50	0.1	40	36
SSM6N24TU	U-MOSIII	UF6	30	0.5	0.145	30
SSM6N25TU	U-MOSIII	UF6	20	0.5	0.145	30
SSM6N29TU	U-MOSIII	UF6	20	0.8	0.143	30
SSM6N35FE	π -MOSVI	ES6	20	0.18	20	36
SSM6N35FU	π -MOSVI	US6	20	0.18	20	36
SSM6N36FE	U-MOSIII	ES6	20	0.5	1.52	36
SSM6N36TU	U-MOSIII	UF6	20	0.5	1.52	36
SSM6N37CTD	U-MOSIII	CST6D	20	0.25	5.6	36
SSM6N39TU	U-MOSIII	UF6	20	1.6	0.119	30
SSM6N40TU	U-MOSIII	UF6	30	1.6	0.182	30
SSM6N42FE	U-MOSIII	ES6	20	0.77	0.26	30
SSM6N43FU	U-MOSIII	US6	20	0.5	1.52	36
SSM6N44FE	π -MOSVI	ES6	30	0.1	7	36
SSM6N44FU	π -MOSVI	US6	30	0.1	7	36
SSM6N7002AFU	π -MOSV	US6	60	0.2	3.3	36
SSM6N7002BFE	U-MOSIV	ES6	60	0.2	3.3	36
SSM6N7002BFU	U-MOSIV	US6	60	0.2	3.3	36
SSM6N7002FU	π -MOSVI	US6	60	0.2	3.3	36
SSM6P05FU	π -MOSVI	US6	-20	-0.2	4	36
SSM6P09FU	π -MOSVI	US6	-30	-0.2	4.2	36
SSM6P15FE	π -MOSVI	ES6	-30	-0.1	32	36
SSM6P15FU	π -MOSVI	US6	-30	-0.1	32	36
SSM6P16FE	π -MOSVI	ES6	-20	-0.1	45	36
SSM6P16FU	π -MOSVI	US6	-20	-0.1	45	36
SSM6P25TU	U-MOSIII	UF6	-20	-0.5	0.26	30
SSM6P26TU	U-MOSIII	UF6	-20	-0.5	0.23	30
SSM6P28TU	U-MOSIII	UF6	-20	-0.8	0.234	30
SSM6P35FE	π -MOSVI	ES6	-20	-0.1	44	36
SSM6P35FU	π -MOSVI	US6	-20	-0.1	44	36
SSM6P36FE	U-MOSIII	ES6	-20	-0.33	3.6	36
SSM6P36TU	U-MOSIII	UF6	-20	-0.33	3.6	36
SSM6P39TU	U-MOSIII	UF6	-20	-1.5	0.213	30
SSM6P40TU	U-MOSIII	UF6	-30	-1.4	0.403	30
SSM6P41FE	U-MOSV	ES6	-20	-0.72	0.3	30
SSM6P54TU	U-MOSIV	UF6	-20	-1.2	0.228	30
TJ20A10M3	U-MOSVI	TO-220SIS	-100	-20	0.09	38
TJ70A06J3	U-MOSIII	TO-220SIS	-60	-70	0.008	38
TJ120F06J3	U-MOSIII	TO-220SM(W)	-60	-120	0.008	37,38

Part Number	Series	Package	Main Characteristics			Page
			V _{DSS} (V)	I _D (A)	R _{DS(ON)} Max (Ω)	
TK100F04K3	U-MOSIV	TO-220SM(W)	40	100	0.003	37,38
TK100F04K3L	U-MOSIV	TO-220SM(W)	40	100	0.003	37,38
TK100F06K3	U-MOSIV	TO-220SM(W)	60	100	0.005	37,38
TK10A50D	π -MOSVII	TO-220SIS	500	10	0.72	40
TK10A60D	π -MOSVII	TO-220SIS	600	10	0.75	40
TK11A50D	π -MOSVII	TO-220SIS	500	11	0.6	40
TK11A55D	π -MOSVII	TO-220SIS	550	11	0.63	40
TK11A60D	π -MOSVII	TO-220SIS	600	11	0.65	40
TK12A50D	π -MOSVII	TO-220SIS	500	12	0.52	40
TK12A53D	π -MOSVII	TO-220SIS	525	12	0.58	40
TK12A55D	π -MOSVII	TO-220SIS	550	12	0.57	40
TK12A60D	π -MOSVII	TO-220SIS	600	12	0.55	40
TK12A60U	DTMOSII	TO-220SIS	600	12	0.4	41
TK12D60U	DTMOSII	TO-220(W)	600	12	0.4	41
TK12J55D	π -MOSVII	TO-3P(N)	550	12	0.57	40
TK12J60U	DTMOSII	TO-3P(N)	600	12	0.4	41
TK12X53D	π -MOSVII	TFP	550	12	0.58	40
TK130F06K3	U-MOSIV	TO-220SM(W)	60	130	0.0034	37
TK13A45D	π -MOSVII	TO-220SIS	450	13	0.46	40
TK13A50D	π -MOSVII	TO-220SIS	500	13	0.4	40
TK13A50DA	π -MOSVII	TO-220SIS	500	12.5	0.47	40
TK13A55DA	π -MOSVII	TO-220SIS	550	12.5	0.48	40
TK13A60D	π -MOSVII	TO-220SIS	600	13	0.43	40
TK13A65U	DTMOSII	TO-220SIS	650	13	0.38	41
TK14A55D	π -MOSVII	TO-220SIS	550	14	0.37	40
TK150F04K3	U-MOSIV	TO-220SM(W)	40	150	0.0021	37
TK150F04K3L	U-MOSIV	TO-220SM(W)	40	150	0.0021	37
TK15A50D	π -MOSVII	TO-220SIS	500	15	0.3	40
TK15A60D	π -MOSVII	TO-220SIS	600	15	0.37	40
TK15A60U	DTMOSII	TO-220SIS	600	15	0.3	41
TK15D60U	DTMOSII	TO-220(W)	600	15	0.3	41
TK15J50D	π -MOSVII	TO-3P(N)	500	15	0.4	40
TK15J60T	DTMOSI	TO-3P(N)	600	15	0.28	41
TK15J60U	DTMOSII	TO-3P(N)	600	15	0.3	41
TK16J55D	π -MOSVII	TO-3P(N)	550	16	0.37	40
TK18A50D	π -MOSVII	TO-220SIS	500	18	0.27	40
TK20A60T	DTMOSI	TO-220SIS	600	20	0.19	41
TK20A60U	DTMOSII	TO-220SIS	600	20	0.19	41
TK20D60T	DTMOSI	TO-220(W)	600	20	0.19	41
TK20D60U	DTMOSII	TO-220(W)	600	20	0.19	41
TK20J50D	π -MOSVII	TO-3P(N)	500	20	0.27	40
TK20J60T	DTMOSI	TO-3P(N)	600	20	0.19	41
TK20J60U	DTMOSII	TO-3P(N)	600	20	0.19	41
TK25A10K3	U-MOSIV	TO-220SIS	100	25	0.04	38
TK2Q60D	π -MOSVII	NewPW-Mold2	600	2	5	40
TK30A06J3A	U-MOSIII	TO-220SIS	60	30	0.026	38
TK3A60DA	π -MOSVII	TO-220SIS	600	2.5	2.8	40
TK40A08K3	U-MOSIV	TO-220SIS	75	40	0.009	39
TK40A10J1	U-MOSIII-H	TO-220SIS	100	40	0.015	39
TK40A10K3	U-MOSIV	TO-220SIS	100	40	0.015	39
TK40D10J1	U-MOSIII-H	TO-220(W)	100	40	0.015	39
TK40J60T	DTMOSI	TO-3P(N)	600	40	0.08	41
TK40P03M1	U-MOSVI-H	DPAK	30	40	0.0108	35
TK40P04M1	U-MOSVI-H	DPAK	40	40	0.0103	35
TK40X10J1	U-MOSIII-H	TFP	100	40	0.02	38,39
TK4A50D	π -MOSVII	TO-220SIS	500	4	2	40

Part Number	Series	Package	Main Characteristics			Page
			V _{DSS} (V)	I _D (A)	R _{DS(ON)} Max (Ω)	
TK4A53D	π-MOSVII	TO-220SIS	525	4	1.7	40
TK4A55D	π-MOSVII	TO-220SIS	550	4	1.9	40
TK4A55DA	π-MOSVII	TO-220SIS	550	3.5	2.45	40
TK4A60D	π-MOSVII	TO-220SIS	600	4	1.7	40
TK4A60DA	π-MOSVII	TO-220SIS	600	3.5	2.2	40
TK4A60DB	π-MOSVII	TO-220SIS	600	3.7	2	40
TK50F15J1	U-MOSIII	TO-220SM(W)	150	50	0.03	37,38
TK50P03M1	U-MOSVI-H	DPAK	30	50	0.0075	35
TK50P04M1	U-MOSVI-H	DPAK	40	50	0.0087	35
TK50X15J1	U-MOSIII-H	TFP	150	50	0.03	39
TK55A10J1	U-MOSIII-H	TO-220SIS	100	55	0.0105	39
TK55D10J1	U-MOSIII-H	TO-220(W)	100	55	0.0105	39
TK5A50D	π-MOSVII	TO-220SIS	500	5	1.5	40
TK5A53D	π-MOSVII	TO-220SIS	525	5	1.5	40
TK5A55D	π-MOSVII	TO-220SIS	550	5	1.88	40
TK5A65D	π-MOSVII	TO-220SIS	650	5	1.45	40
TK60A08J1	U-MOSIII-H	TO-220SIS	75	60	0.0078	39
TK60D08J1	U-MOSIII-H	TO-220(W)	75	60	0.0078	39
TK6A50D	π-MOSVII	TO-220(W)	500	6	1.4	40
TK6A53D	π-MOSVII	TO-220SIS	525	6	1.3	40
TK6A55DA	π-MOSVII	TO-220SIS	550	5.5	1.48	40
TK6A60D	π-MOSVII	TO-220SIS	600	6	1.25	40
TK6A65D	π-MOSVII	TO-220SIS	650	6	1.11	40
TK6P53D	π-MOSVII	DPAK	525	6	1.3	40
TK70A06J1	U-MOSIII-H	TO-220SIS	60	70	0.0064	39
TK70D06J1	U-MOSIII-H	TO-220(W)	60	70	0.0064	39
TK70J04J3	U-MOSIII	TO-3P(N)	40	70	0.0038	38
TK70X04K3	U-MOSIV	TFP	40	70	0.0056	38
TK70X04K3L	U-MOSIV	TFP	40	70	0.0056	–
TK70X04K3Z	U-MOSIV	TFP	40	70	0.0056	38
TK70X06K3	U-MOSIV	TFP	60	70	0.008	38
TK7A50D	π-MOSVII	TO-220SIS	500	7	1.22	40
TK80A08K3	U-MOSIV	TO-220SIS	75	80	0.0045	39
TK80D08K3	U-MOSIV	TO-220(W)	75	80	0.0045	39
TK80X04K3	U-MOSIV	TFP	40	80	0.0035	38
TK8A50D	π-MOSVII	TO-220SIS	500	8	0.85	40
TK8A50DA	π-MOSVII	TO-220SIS	500	7.5	1.0	40
TK8A55DA	π-MOSVII	TO-220SIS	550	7.5	1.07	40
TK8A60DA	π-MOSVII	TO-220SIS	600	7.5	1	40
TK8A65D	π-MOSVII	TO-220SIS	650	8	0.84	40
TK9A55DA	π-MOSVII	TO-220SIS	550	8.5	0.86	40
TPC6004	U-MOSIII	VS-6	20	6	0.024	31
TPC6005	U-MOSIII	VS-6	30	6	0.028	31
TPC6006-H	U-MOSIII-H	VS-6	40	3.9	0.075	24,31
TPC6007-H	U-MOSIII-H	VS-6	30	5	0.054	24,31
TPC6011	U-MOSIV	VS-6	30	6	0.020	31
TPC6103	U-MOSIII	VS-6	-12	-5.5	0.035	31
TPC6105	U-MOSIII	VS-6	-20	-2.7	0.11	31
TPC6107	U-MOSIV	VS-6	-20	-4.5	0.055	31
TPC6108	U-MOSIV	VS-6	-30	-4.5	0.06	31
TPC6109-H	U-MOSIII-H	VS-6	-30	-5	0.059	24,31
TPC6111	U-MOSV	VS-6	-20	-5.5	0.04	31
TPC6201	U-MOSII	VS-6	30	2.5	0.095	–
TPC8012-H	π-MOSV	SOP-8	200	1.8	0.4	34
TPC8014	U-MOSIII	SOP-8	30	11	0.014	27
TPC8017-H	U-MOSIII-H	SOP-8	30	15	0.0066	–

Part Number	Series	Package	Main Characteristics			Page
			V _{DSS} (V)	I _D (A)	R _{DS(ON)} Max (Ω)	
TPC8018-H	U-MOSIII-H	SOP-8	30	18	0.0046	–
TPC8020-H	U-MOSIII-H	SOP-8	30	13	0.009	–
TPC8021-H	U-MOSIII-H	SOP-8	30	11	0.017	24,33
TPC8022-H	U-MOSIII-H	SOP-8	40	7.5	0.027	24,34
TPC8025	U-MOSIV	SOP-8	30	11	0.009	27,33
TPC8026	U-MOSIV	SOP-8	30	13	0.0066	27,33
TPC8027	U-MOSIV	SOP-8	30	18	0.0027	27,34
TPC8028	U-MOSIV	SOP-8	30	18	0.0043	27,34
TPC8029	U-MOSIV	SOP-8	30	18	0.0038	27,34
TPC8030	U-MOSIV	SOP-8	30	11	0.0095	27,33
TPC8031-H	U-MOSV-H	SOP-8	30	11	0.0133	24
TPC8032-H	U-MOSV-H	SOP-8	30	15	0.0065	24,33
TPC8033-H	U-MOSV-H	SOP-8	30	17	0.0053	24,33
TPC8034-H	U-MOSV-H	SOP-8	30	18	0.0035	24,34
TPC8035-H	U-MOSVI-H	SOP-8	30	18	0.0032	24,34
TPC8036-H	U-MOSVI-H	SOP-8	30	18	0.0045	24,34
TPC8037-H	U-MOSV-H	SOP-8	30	12	0.0114	24,33
TPC8038-H	U-MOSV-H	SOP-8	30	12	0.0114	24,33
TPC8039-H	U-MOSVI-H	SOP-8	30	17	0.006	24,33
TPC8040-H	U-MOSVI-H	SOP-8	30	13	0.0097	24,33
TPC8045-H	U-MOSVI-H	SOP-8	40	18	0.0039	24,34
TPC8046-H	U-MOSVI-H	SOP-8	40	18	0.0057	24,34
TPC8047-H	U-MOSVI-H	SOP-8	40	16	0.0076	24,34
TPC8048-H	U-MOSVI-H	SOP-8	60	16	0.0069	25,34
TPC8049-H	U-MOSVI-H	SOP-8	60	13	0.0107	25,34
TPC8050-H	U-MOSVI-H	SOP-8	60	11	0.0145	25,34
TPC8051-H	U-MOSVI-H	SOP-8	80	13	0.0097	25,34
TPC8052-H	U-MOSVI-H	SOP-8	40	12	0.0115	24,34
TPC8053-H	U-MOSVI-H	SOP-8	60	9	0.0225	25,34
TPC8107	U-MOSIII	SOP-8	-30	-13	0.007	–
TPC8109	U-MOSIII	SOP-8	-30	-10	0.02	–
TPC8110	U-MOSIII	SOP-8	-40	-8	0.025	34
TPC8111	U-MOSIV	SOP-8	-30	-11	0.012	34
TPC8112	U-MOSIII	SOP-8	-30	-13	0.006	–
TPC8113	U-MOSIV	SOP-8	-30	-11	0.01	27,34
TPC8114	U-MOSIV	SOP-8	-30	-18	0.0045	27,34
TPC8115	U-MOSIV	SOP-8	-20	-10	0.01	27,34
TPC8116-H	U-MOSIII-H	SOP-8	-40	-7.5	0.03	25,34
TPC8117	U-MOSV	SOP-8	-30	-18	0.0039	27,34
TPC8118	U-MOSV	SOP-8	30	13	0.007	27,34
TPC8120	U-MOSVI	SOP-8	-30	-18	0.0032	27,34
TPC8122	U-MOSV	SOP-8	-30	-11	0.008	27,34
TPC8123	U-MOSVI	SOP-8	-30	-11	0.0095	27,34
TPC8207	U-MOSIII	SOP-8	20	6	0.02	27,34
TPC8208	U-MOSIII	SOP-8	20	5	0.05	27,34
TPC8210	U-MOSIII	SOP-8	30	8	0.015	27,34
TPC8211	U-MOSIII	SOP-8	30	5.5	0.036	27,34
TPC8212-H	U-MOSIII-H	SOP-8	30	6	0.021	34
TPC8213-H	U-MOSIII-H	SOP-8	60	5	0.05	25,34
TPC8214-H	U-MOSIII-H	SOP-8	100	2.2	0.18	25,34
TPC8218-H	U-MOSVI-H	SOP-8	60	3.8	0.057	25,34
TPC8404	π-MOSV/π-MOSV	SOP-8	-250/250	1.1/-0.9	1.7/2.55	34
TPC8405	U-MOSIV/U-MOSIII	SOP-8	-30/30	-4.5/6	0.027	27,34
TPC8406-H	U-MOSIII-H	SOP-8	40	6.5	0.03	25,34
TPC8406-H	U-MOSIII-H	SOP-8	-40	-6.5	0.025	25,34
TPC8A01	High-speed U-MOSIII	SOP-8	30	6	0.018	34

Part Number	Series	Package	Main Characteristics			Page
			V _{bss} (V)	I _D (A)	R _{DS(ON)} Max (Ω)	
TPC8A01	U-MOSIII	SOP-8	30	8.5/1	0.0056	34
TPC8A02-H	U-MOSIII-H	SOP-8	30	16/1	0.0056	–
TPC8A03-H	U-MOSV-H	SOP-8	30	17/1	0.0036	25,34
TPC8A04-H	U-MOSV-H	SOP-8	30	18/1	0.0133	25,34
TPC8A05-H	U-MOSV-H	SOP-8	30	10/1	0.0066	25,34
TPC8A06-H	U-MOSV-H	SOP-8	30	12	0.0101	25,34
TPCA8003-H	U-MOSIII-H	SOP Advance	30	35	0.0046	–
TPCA8004-H	U-MOSIII-H	SOP Advance	30	40	0.009	–
TPCA8005-H	U-MOSIII-H	SOP Advance	30	27	0.067	–
TPCA8006-H	π -MOSVII	SOP Advance	100	18	0.58	35
TPCA8008-H	π -MOSV	SOP Advance	250	4	0.35	25,35
TPCA8009-H	π -MOSV	SOP Advance	150	7	0.45	25,35
TPCA8010-H	π -MOSV	SOP Advance	200	5.5	0.0035	25,35
TPCA8011-H	U-MOSIII-H	SOP Advance	20	40	0.0049	24,35
TPCA8012-H	U-MOSV-H	SOP Advance	30	35	0.0049	24,35
TPCA8014-H	U-MOSIII-H	SOP Advance	40	30	0.0054	24,35
TPCA8015-H	U-MOSIII-H	SOP Advance	40	35	0.021	24,35
TPCA8016-H	U-MOSIII-H	SOP Advance	60	25	0.0062	25,35
TPCA8018-H	U-MOSV-H	SOP Advance	30	27	0.0031	24,35
TPCA8019-H	U-MOSV-H	SOP Advance	30	40	0.027	24,35
TPCA8020-H	U-MOSIII-H	SOP Advance	40	7.5	0.027	24,35
TPCA8022-H	U-MOSIII-H	SOP Advance	100	22	0.026	25,35
TPCA8023-H	U-MOSV-H	SOP Advance	30	21	0.0129	24
TPCA8024	U-MOSIV	SOP Advance	30	35	0.0043	27,35
TPCA8025	U-MOSIV	SOP Advance	30	40	0.0036	27,35
TPCA8026	U-MOSIV	SOP Advance	30	45	0.0022	27,35
TPCA8027-H	U-MOSIII	SOP Advance	40	30	0.01	24,35
TPCA8028-H	U-MOSVI-H	SOP Advance	30	50	0.0028	24,35
TPCA8030-H	U-MOSV-H	SOP Advance	30	24	0.011	24,35
TPCA8031-H	U-MOSV-H	SOP Advance	30	24	0.011	24,35
TPCA8036-H	U-MOSVI-H	SOP Advance	30	38	0.0042	24,35
TPCA8039-H	U-MOSVI-H	SOP Advance	30	34	0.0057	24,35
TPCA8040-H	U-MOSVI-H	SOP Advance	30	23	0.0094	24,35
TPCA8045-H	U-MOSVI-H	SOP Advance	40	46	0.0036	24,35
TPCA8046-H	U-MOSVI-H	SOP Advance	40	38	0.0054	24,35
TPCA8047-H	U-MOSVI-H	SOP Advance	40	32	0.0073	24,35
TPCA8048-H	U-MOSVI-H	SOP Advance	60	35	0.0066	25,35
TPCA8049-H	U-MOSVI-H	SOP Advance	60	28	0.0104	25,35
TPCA8050-H	U-MOSVI-H	SOP Advance	60	24	0.0142	25,35
TPCA8051-H	U-MOSVI-H	SOP Advance	80	28	0.0094	25,35
TPCA8052-H	U-MOSVI-H	SOP Advance	40	20	0.0113	24,35
TPCA8053-H	U-MOSVI-H	SOP Advance	60	15	0.0223	25,35
TPCA8060-H	U-MOSVI-H	SOP Advance	30	45	0.0034	24,35
TPCA8101	U-MOSIII	SOP Advance	–30	–40	0.007	–
TPCA8102	U-MOSIII	SOP Advance	–30	–40	0.006	–
TPCA8103	U-MOSIV	SOP Advance	–30	–40	0.0042	27,35
TPCA8104	U-MOSIII	SOP Advance	–60	–40	0.016	35,38
TPCA8105	U-MOSIII	SOP Advance	–12	–6	0.0033	27,35
TPCA8106	U-MOSV	SOP Advance	–30	–40	0.0037	27,35
TPCA8107-H	U-MOSIII-H	SOP Advance	–40	–7.5	0.03	25,35
TPCA8108	U-MOSIII	SOP Advance	–40	–40	0.0095	35
TPCA8A01-H	U-MOSIII-H	SOP Advance	30	36	0.0056	–
TPCA8A02-H	U-MOSV-H	SOP Advance	30	34	0.0053	25,35
TPCA8A04-H	U-MOSV-H	SOP Advance	30	44	0.0032	25,35
TPCA8A05-H	U-MOSV-H	SOP Advance	30	10	0.0129	25,35
TPCA8A08-H	U-MOSV-H	SOP Advance	30	38	0.0042	25,35

Part Number	Series	Package	Main Characteristics			Page
			V _{bss} (V)	I _D (A)	R _{DS(ON)} Max (Ω)	
TPCC8001-H	U-MOSV-H	TSOP Advance	30	22	0.0083	24,33
TPCC8002-H	U-MOSV-H	TSOP Advance	30	22	0.0083	24,33
TPCC8003-H	U-MOSIV-H	TSOP Advance	30	13	0.0169	24,33
TPCC8005-H	U-MOSV-H	TSOP Advance	30	26	0.0064	24,33
TPCC8006-H	U-MOSIV-H	TSOP Advance	30	22	0.008	24,33
TPCC8007	U-MOSIV	TSOP Advance	20	27	(0.0046)	27,33
TPCC8008	U-MOSIV	TSOP Advance	30	25	0.0068	27,33
TPCC8102	U-MOSV	TSOP Advance	–30	–15	0.0189	27,33
TPCC8103	U-MOSV	TSOP Advance	–30	–18	0.012	27,33
TPCC8A01-H	U-MOSV-H	TSOP Advance	30	21	0.0099	25,33
TPCF8002	U-MOSIV	VS-8	30	7	0.023	31
TPCF8101	U-MOSIII	VS-8	–12	–6	0.028	31
TPCF8102	U-MOSIII	VS-8	–20	–6	0.03	31
TPCF8103	U-MOSIII	VS-8	–20	–2.7	0.11	31
TPCF8104	U-MOSIII	VS-8	–30	–6	0.028	31
TPCF8201	U-MOSIII	VS-8	20	3	0.049	31
TPCF8301	U-MOSIII	VS-8	–20	–2.7	0.11	31
TPCF8302	U-MOSIII	VS-8	–20	–3	0.059	31
TPCF8303	U-MOSIII	VS-8	–20	–3	0.058	31
TPCF8304	U-MOSIV	VS-8	–30	–3.2	0.072	31
TPCF8402	U-MOSIII	VS-8	–30/30	–3.2/4	0.072/0.05	31
TPCF8A01	U-MOSIII	VS-8	20	3	0.049	31
TPCF8B01	U-MOSIII	VS-8	–20	–2.7	0.11	31
TPCL4201	U-MOSV	Chip LGA	20	6	0.031	27,32
TPCL4202	U-MOSV	Chip LGA	30	6	0.04	27,32
TPCL4203	U-MOSV	Chip LGA	24	6	0.036	27,32
TPCM8001-H	U-MOSIII-H	TSSOP Advance	30	20	0.0095	33
TPCM8002-H	U-MOSV-H	TSSOP Advance	30	30	0.0062	24,33
TPCM8003-H	U-MOSV-H	TSSOP Advance	30	21	0.0129	24,33
TPCM8004-H	U-MOSV-H	TSSOP Advance	30	24	0.011	24,33
TPCM8A05-H	U-MOSV-H	TSSOP Advance	30	20	0.0129	25,33
TPCP8001-H	U-MOSIII-H	PS-8	30	7.2	0.016	32
TPCP8003-H	U-MOSIII-H	PS-8	100	2.2	0.19	25,32
TPCP8004	U-MOSIV	PS-8	30	8.3	0.009	27,32
TPCP8005-H	U-MOSV-H	PS-8	30	11	0.0133	24,32
TPCP8006	U-MOSIV	PS-8	20	9.1	0.01	27,32
TPCP8101	U-MOSIII	PS-8	–20	–5.6	0.03	32
TPCP8102	U-MOSIV	PS-8	–20	–7.6	0.018	32
TPCP8103-H	U-MOSIII-H	PS-8	–40	–4.8	0.04	25,32
TPCP8201	U-MOSIII	PS-8	30	4.2	0.05	32
TPCP8202	U-MOSIV	PS-8	30	5.5	0.023	27,32
TPCP8203	U-MOSIII	PS-8	40	4.7	0.04	32
TPCP8301	U-MOSIV	PS-8	–20	–5	0.031	32
TPCP8302	U-MOSIV	PS-8	–20	–5	0.033	32
TPCP8303	U-MOSV	PS-8	–20	–3.8	0.04	32
TPCP8401	U-MOSIII	PS-8	–12/20	–5.5/0.1	0.038/3	32
TPCP8402	U-MOSIII	PS-8	–30/30	–3.4/4.2	0.048/0.072	32
TPCP8403	U-MOSIV/U-MOSIII	PS-8	–40/40	–3.4/4.7	0.170/0.040	32
TPCP8404	U-MOSV/U-MOSIV	PS-8	–30/30	–4/4	0.05/0.05	32
TPCP8A05-H	U-MOSV-H	PS-8	30	8	0.0175	32
TPCP8AA1	U-MOSII	PS-8	20	1.6	0.105	32
TPCP8BA1	U-MOSII	PS-8	–20	–1.3	0.18	32
TPCP8J01	U-MOSIV	PS-8	–32/50	–6/0.1	0.035	32
TPCT4203	U-MOSIV	STP2	20	6	0.031	27,32
TPCT4204	U-MOSIV	STP2	30	6	0.038	27,32

8-1 End-of-Life Products

The part numbers in the left-hand column below are end-of-life or obsolete products. When ordering, please choose from the replacement products in the right-hand column.

End-of-Life Products				Replacement Products					
Part Number	Electrical Characteristics			Package	Part Number	Electrical Characteristics			Package
	V _{DSS} (V)	I _D (A)	R _{DS(ON)} Max(Ω)			V _{DSS} (V)	I _D (A)	R _{DS(ON)} Max(Ω)	
2SJ148	-60	-0.2	2	TO-92	2SJ168	-60	-0.2	2	S-MINI
2SJ167	-60	-0.2	2	N-MINI	2SJ168	-60	-0.2	2	S-MINI
2SJ200	-16	-2	0.71	PW-Mini	TPC6105	-20	-2.7	0.11	VS-6
2SJ342	-50	-0.05	50	N-MINI	2SJ343	-50	-0.05	50	S-MINI
2SJ345	-20	-0.05	40	S-MINI	SSM3J16FU	-20	-0.1	45	USM
2SJ346	-20	-0.05	40	USM	SSM3J16FU	-20	-0.1	45	USM
2SJ347	-20	-0.05	40	SSM	SSM3J16FS	-20	-0.1	45	SSM
2SJ511	-30	-2	0.76	PW-Mini	TPC6108	-30	-4.5	0.006	VS-6
2SJ525	-30	-5	0.12	TPS	TPCF8104	-30	-6	0.028	VS-8
2SK1061	60	0.2	1	N-MINI	SSM3K7002BF	60	0.2	2.1	S-MINI
2SK1120	1000	8	1.8	TO-3P (N)	2SK2613	1000	8	1.7	TO-3P (N)
2SK1825	50	0.05	50	N-MINI	SSM3K7002BF	60	0.2	2.1	S-MINI
2SK1826	50	0.05	50	S-MINI	SSM3K7002BF	60	0.2	2.1	S-MINI
2SK1827	50	0.05	50	USM	SSM3K7002BFU	60	0.2	2.1	USM
2SK1828	20	0.05	40	S-MINI	SSM3K15F	30	0.1	7	S-MINI
2SK1829	20	0.05	40	USM	SSM3K15FU	30	0.1	7	USM
2SK1830	20	0.05	40	SSM	SSM3K15FS	30	0.1	7	SSM
2SK2033	20	0.1	12	S-MINI	SSM3K15F	30	0.1	7	S-MINI
2SK2034	20	0.1	12	USM	SSM3K15FU	30	0.1	7	USM
2SK2035	20	0.1	12	SSM	SSM3K15FS	30	0.1	7	SSM
2SK2036	20	0.1	6	S-MINI	SSM3K15F	30	0.1	7	S-MINI
2SK2037	20	0.1	6	USM	SSM3K15FU	30	0.1	7	USM
2SK2312	60	45	0.017	TO-220NIS	2SK3844	60	45	0.0058	TO-220NIS
2SK2466	100	30	0.046	TO-220NIS	TK40A10K3	100	40	0.015	TO-220SIS
2SK2543	500	8	0.85	TO-220NIS	TK8A50D	500	8	0.85	TO-220SIS
2SK2544	600	6	1.25	TO-220AB	2SK3761	600	6	1.25	TO-220AB
2SK2545	600	6	1.25	TO-220NIS	TK6A60D	600	6	1.25	TO-220SIS
2SK2549	16	2	0.29	PW-Mini	TPC6004	20	6	0.024	VS-6
2SK2604	800	5	2.2	TO-3P (N)	2SK3633	800	7	1.7	TO-3P (N)
2SK2605	800	5	2.2	TO-220NIS	2SK4013	800	6	1.7	TO-220SIS
2SK2610	900	5	2.5	TO-3P (N)	2SK3700	900	5	2.5	TO-3P (N)
2SK2611	900	9	1.4	TO-3P (N)	2SK3878	900	9	1.3	TO-3P (N)
2SK2661	500	5	1.5	TO-220AB	2SK3758	500	5	1.5	TO-220AB
2SK2662	500	5	1.5	TO-220NIS	TK5A50D	500	5	1.5	TO-220SIS
2SK2698	500	15	0.4	TO-3P (N)	TK15J50D	500	15	0.4	TO-3P (N)
2SK2700	900	3	4.3	TO-220NIS	2SK3564	900	3	4.3	TO-220SIS
2SK2717	900	5	2.5	TO-220NIS	2SK3565	900	5	2.5	TO-220SIS
2SK2718	900	2.5	6.4	TO-220NIS	2SK3566	900	2.5	6.4	TO-220SIS
2SK2746	800	7	1.7	TO-3P (N)	2SK3633	800	7	1.7	TO-3P (N)
2SK2749	900	7	2	TO-3P (N)	2SK4115	900	7	2	TO-3P (N)
2SK2750	600	3.5	2.2	TO-220NIS	TK4A60DA	600	3.5	2.2	TO-220SIS
2SK2823	20	0.1	40	S-MINI	SSM3K35FS	20	0.18	20	SSM
2SK2824	20	0.1	40	USM	SSM3K35FS	20	0.18	20	SSM
2SK2825	20	0.1	40	SSM	SSM3K35FS	20	0.18	20	SSM
2SK2837	500	20	0.27	TO-3P (N)	TK20J50D	500	20	0.27	TO-3P (N)
2SK2842	500	12	0.52	TO-220NIS	TK12A50D	500	12	0.52	TO-220SIS
2SK2843	600	10	0.75	TO-220NIS	TK10A60D	600	10	0.75	TO-220SIS
2SK2844	30	35	0.02	TO-220AB	TK70D06J1	60	70	0.0064	TO-220 (W)
2SK2915	600	16	0.4	TO-3P (N)	2SK3903	600	14	0.44	TO-3P (N)
2SK2996	600	10	1	TO-220NIS	2SK4112	600	10	1	TO-220HIS

End-of-Life Products					Replacement Products				
Part Number	Electrical Characteristics			Package	Part Number	Electrical Characteristics			Package
	V _{DSS} (V)	I _D (A)	R _{DS(ON)} Max(Ω)			V _{DSS} (V)	I _D (A)	R _{DS(ON)} Max(Ω)	
2SK2964	30	2	0.18	PW-Mini	TPC6003	30	6	0.024	VS-6
2SK3067	600	2	5	TO-220NIS	2SK3767	600	2	4.5	TO-220SIS
2SK3084	100	30	0.046	TO-220FL/SM	-	-	-	-	-
2SK3089	30	40	0.03	TO-220FL/SM	2SK3847	40	32	0.018	TO-220SM
2SK3090	30	45	0.02	TO-220FL/SM	2SK3847	40	32	0.018	TO-220SM
2SK3125	30	70	0.007	TO-3PSM	2SK3843	40	75	0.0035	TFP
2SK3126	450	10	0.65	TO-220NIS	2SK3869	450	10	0.68	TO-220SIS
2SK3127	30	45	0.012	TO-220FL/SM	2SK3847	40	32	0.018	TO-220SM
2SK3128	30	60	0.012	TO-3P (N)	2SK3843	40	75	0.0035	TFP
2SK3129	50	60	0.007	TO-3P (N)	2SK3845	60	70	0.0058	TO-3P (N)
2SK3130	600	6	1.55	TO-220NIS	2SK3947	600	6	1.4	TO-220SIS
2SK3236	60	35	0.02	TO-220NIS	2SK3662	60	35	0.0125	TO-220NIS
2SK3316	500	5	1.8	TO-220NIS	2SK3868	500	5	1.7	TO-220NIS
2SK3389	30	75	0.005	TFP	2SK3843	40	75	0.008	TFP
2SK3397	30	75	0.006	TFP	2SK3843	40	75	0.0035	TFP
2SK3407	450	10	0.65	TO-220NIS	2SK3869	450	10	0.68	TO-220SIS
2SK3439	30	75	0.005	TFP	2SK3843	40	75	0.0035	TFP
2SK3440	60	50	0.008	TFP	2SK3842	60	75	0.0058	TFP
2SK3441	60	75	0.0058	TFP	2SK4034	60	75	0.0058	TFP
2SK3442	100	45	0.02	TFP	TK40D10J1	100	40	0.015	TO-220 (W)
2SK3443	150	30	0.055	TFP	TK50X15J1	150	50	0.03	TFP
2SK3499	400	10	0.55	TFP	TK10X40D*	400	10	0.55	TFP
2SK3543	450	2	2.45	TO-220NIS	2SK3757	450	2	2.45	TO-220SIS
2SK982	60	0.2	1	TO-92	SSM3K7002BF	60	0.2	2.1	S-MINI
HN1J02FU	-20	-0.05	40	US6	SSM6P16FU	-20	-0.1	45	US6
HN1K02FU	20	0.05	40	US6	SSM6N16FU	20	0.1	15	US6
HN1K03FU	20	0.1	12	US6	SSM6N16FU	20	0.1	15	US6
HN1K04FU	50	0.05	50	US6	SSM6K7002BFU	60	0.2	2.1	US6
HN1K05FU	20	0.1	40	US6	SSM6N35FU	20	0.18	20	US6
HN1K06FU	20	0.1	6	US6	SSM6N15FU	30	0.1	7	US6
HN1L02FU	20	0.05	40	US6	SSM6L35FU	20	0.18	20	US6
HN1L03FU	50	0.05	50	US6	-	-	-	-	-
HN4K03JU	20	0.1	12	UFV	SSM5N15FU	30	0.1	7	USV
SSM3J01F	-30	-0.7	0.6	S-MINI	SSM3J01T	-30	-1.7	0.6	TSM
SSM3J02F	-30	-0.6	0.7	S-MINI	SSM3J02T	-30	-1.6	0.7	TSM
SSM3J15TE	-30	-0.1	32	TESM	SSM3J15FV	-30	-0.1	32	VESM
SSM3J16TE	-20	-0.1	45	TESM	SSM3J16FV	-20	-0.1	45	VESM
SSM3K01F	30	1.3	0.15	S-MINI	SSM3K01T	30	3.2	0.15	TSM
SSM3K02F	30	1	0.25	S-MINI	SSM3K02T	30	2.5	0.25	TSM
SSM3K03C	20	0.1	12	SS-CSP	SSM3K16CT	20	0.1	15	CST3
SSM3K03FE	20	0.1	12	ESM	SSM3K16FS	20	0.1	15	SSM
SSM3K03TE	20	0.1	12	TESM	SSM3K16FV	20	0.1	15	VESM
SSM3K04FE	20	0.1	12	ESM	SSM3K04FS	20	0.1	12	SSM
SSM3K126TU	30	3.9	0.043	UFM	SSM3K131TU	30	6	0.0415	UFM
SSM3K15TE	30	0.1	7	TESM	SSM3K15FV	30	0.1	7	VESM
SSM3K16TE	20	0.1	15	TESM	SSM3K16FV	20	0.1	15	VESM
SSM3K302T	30	3	0.071	TSM	SSM3K316T	30	4	0.065	TSM
SSM3K311T	30	4.6	0.043	TSM	SSM3K315T	30	6	0.0415	TSM
SSM6G06FE	-20	-0.1	45	ES6	-	-	-	-	-
SSM6H06FE	20	0.1	15	ES6	-	-	-	-	-
TPC6106	-40	-3.9	0.08	VS-6	-	-	-	-	-
TPCT4201	20	6	0.031	STP	TPCT4203	20	6	0.031	STP2
TPCT4202	30	6	0.038	STP	TPCT4204	30	6	0.038	STP2
TPC6201	30	2.5	0.095	VS-6	TPCP8202	30	5.5	0.023	PS-8
TPC8301	-30	-3.5	0.12	SOP-8	TPCF8304	-30	3.2	0.105	SOP-8
TPC8303	-30	-4.5	0.035	SOP-8	-	-	-	-	-

*: Under development

9-1 Compact Surface-Mount Packages

Toshiba offers a broad range of packaging options suitable for various mobile applications, including ultra-small, thin packages; those specifically designed for lithium-ion battery protection circuits; high-current packages with a thermal fin on the bottom.

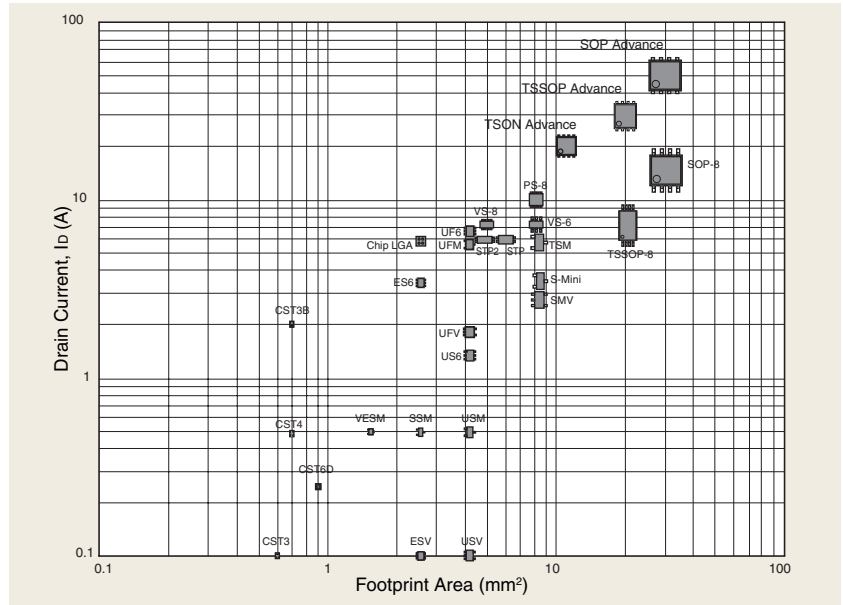

■ CST3

Unit: mm

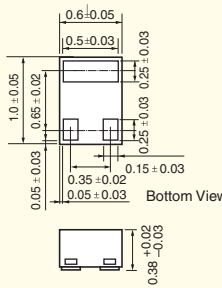
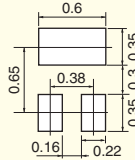
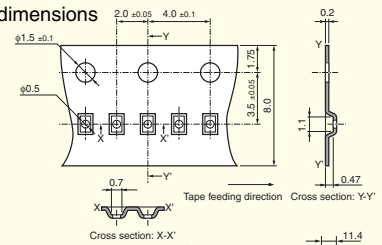
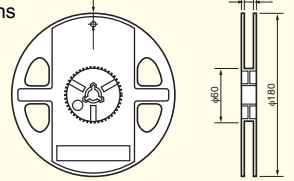
	Package dimensions	Typical PCB land pad dimensions	Tape dimensions
			
			Reel dimensions
			
			Packing quantity
			10000 pcs/reel

■ CST3B

Unit: mm

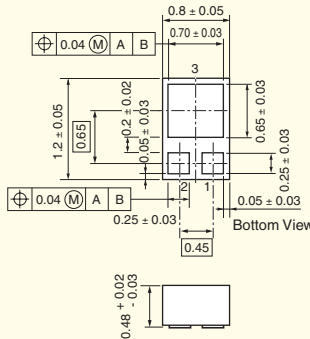
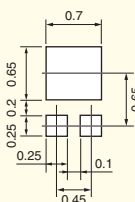
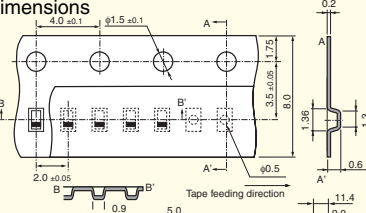
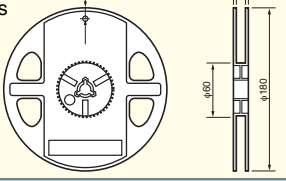
	Package dimensions	Typical PCB land pad dimensions	Tape dimensions
			
			Reel dimensions
			
			Packing quantity
			10000 pcs/reel

■ UFM

Unit: mm

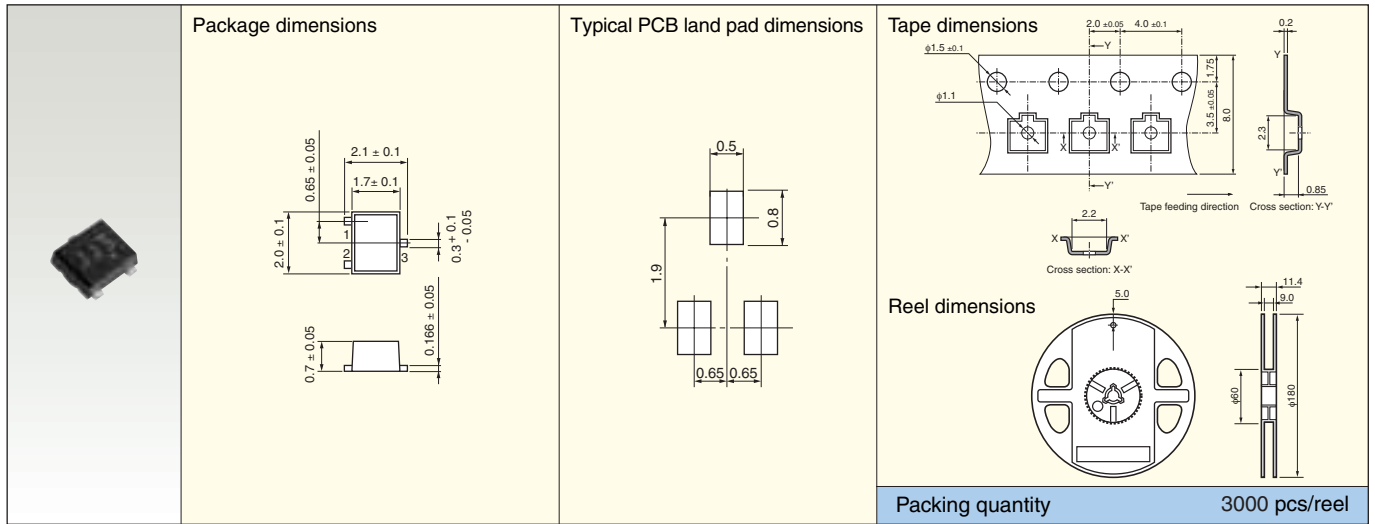

■ S-Mini (SOT-346)(SC-59)

Unit: mm

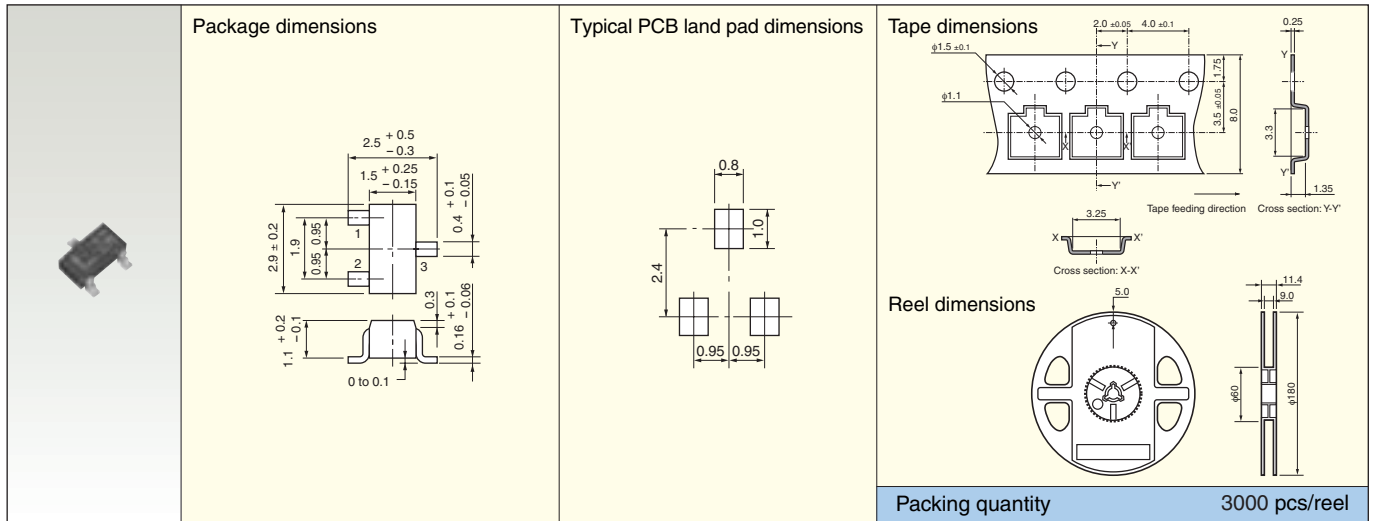

■ TSM

Unit: mm

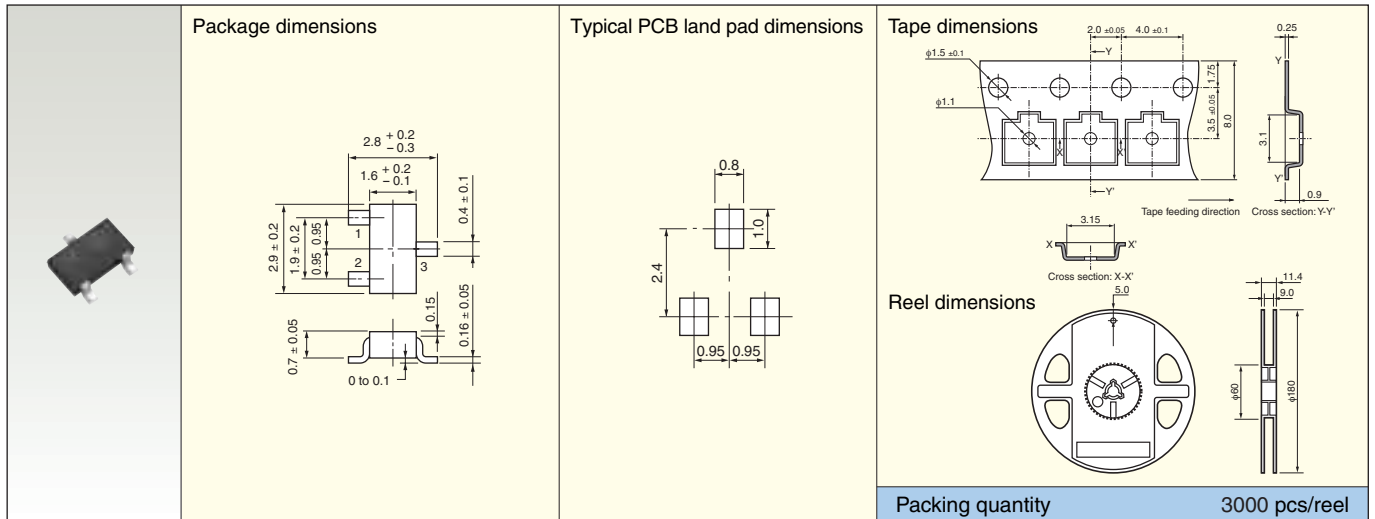

■ CST4

Unit: mm

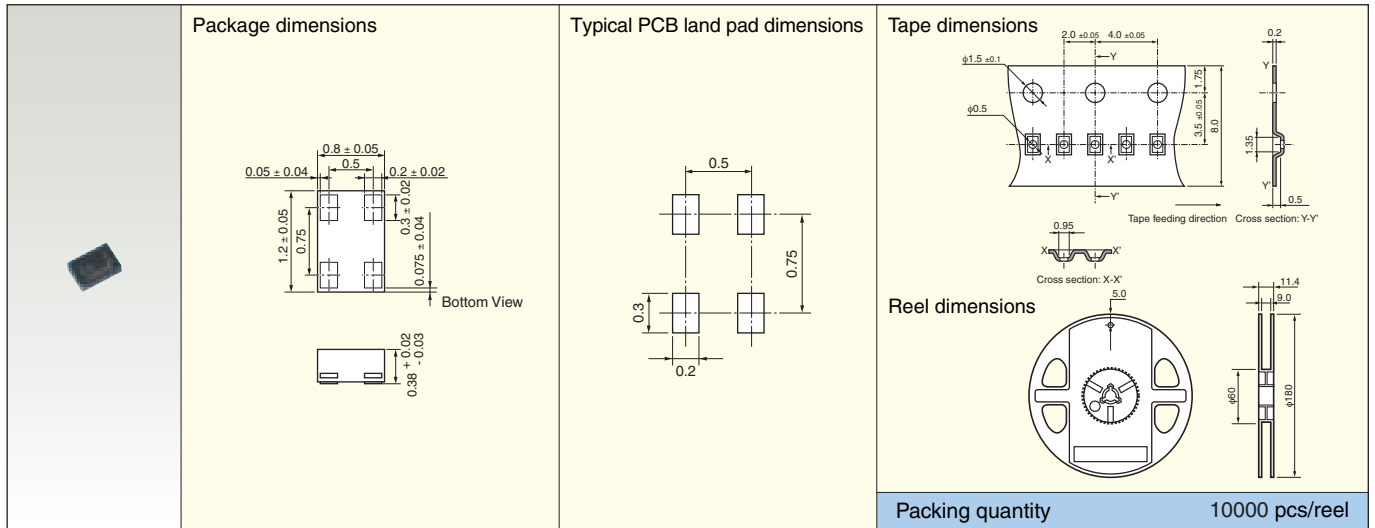

■ ESV (SOT-553)

Unit: mm

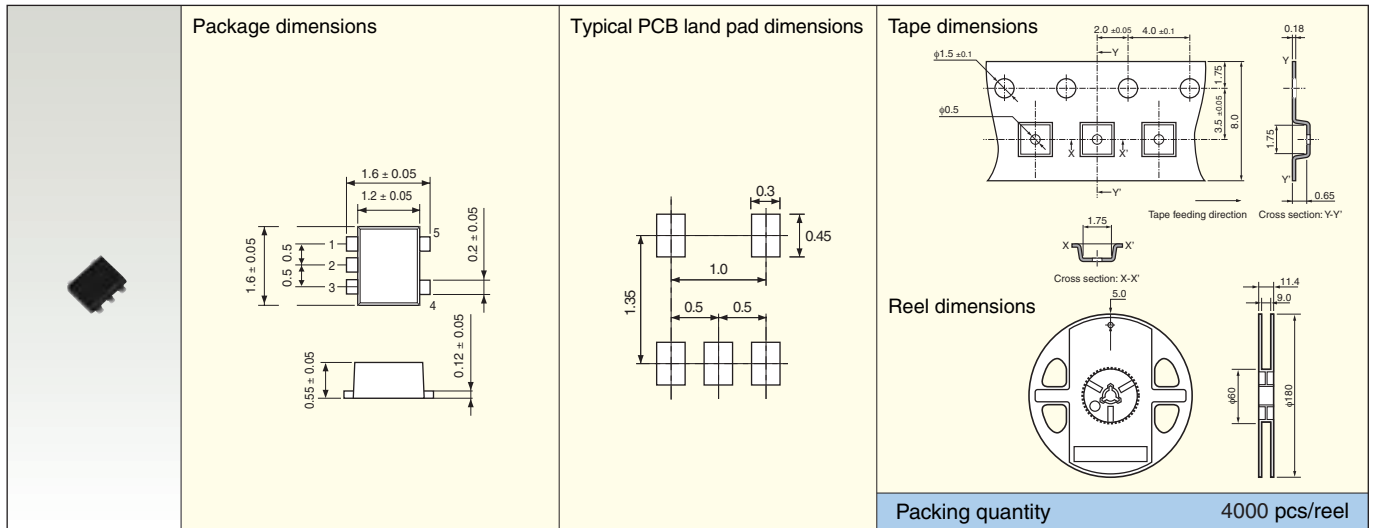

■ USV (SOT-353)(SC-88A)

Unit: mm

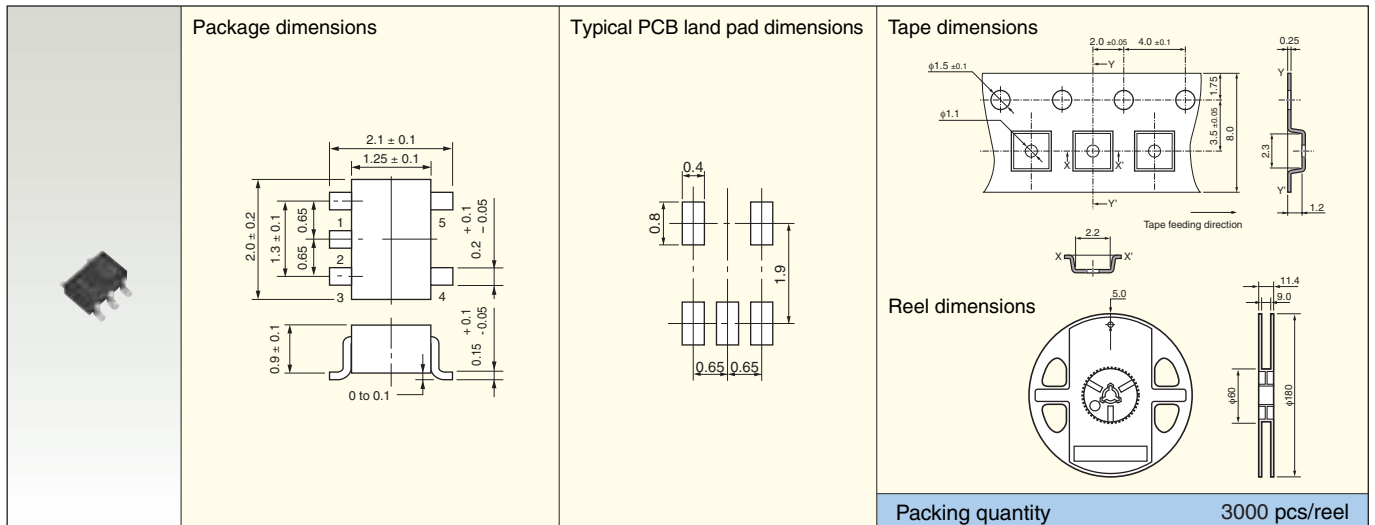

■ UFV

Unit: mm



■ SMV (SOT-25)(SC-74A)

Unit: mm



■ CST6D

Unit: mm

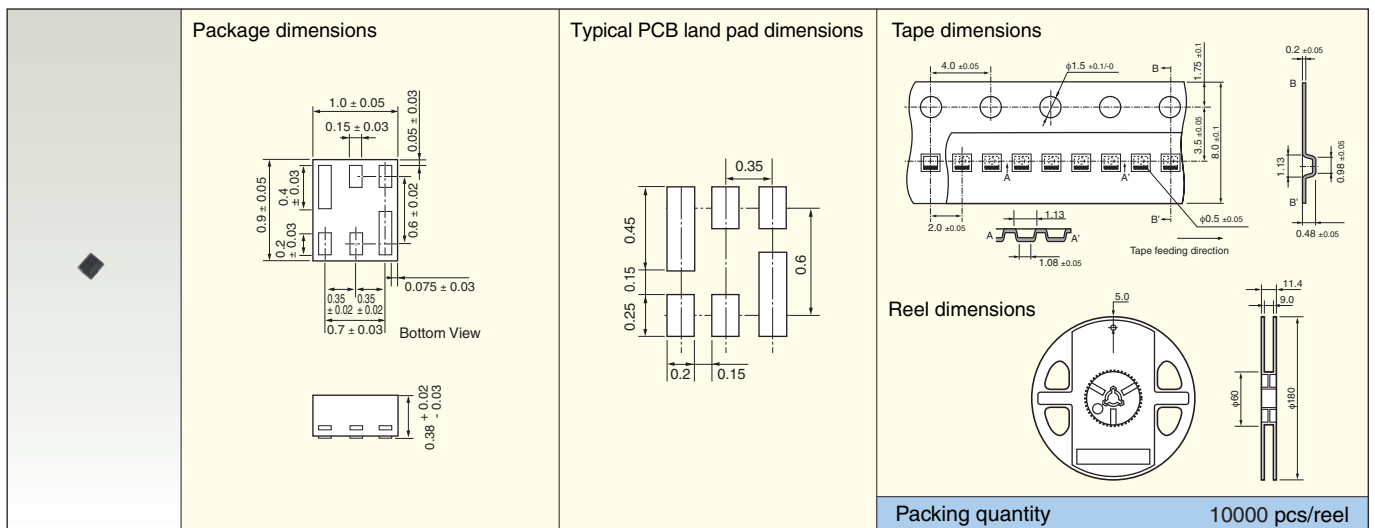

■ ES6 (SOT-563)

Unit: mm

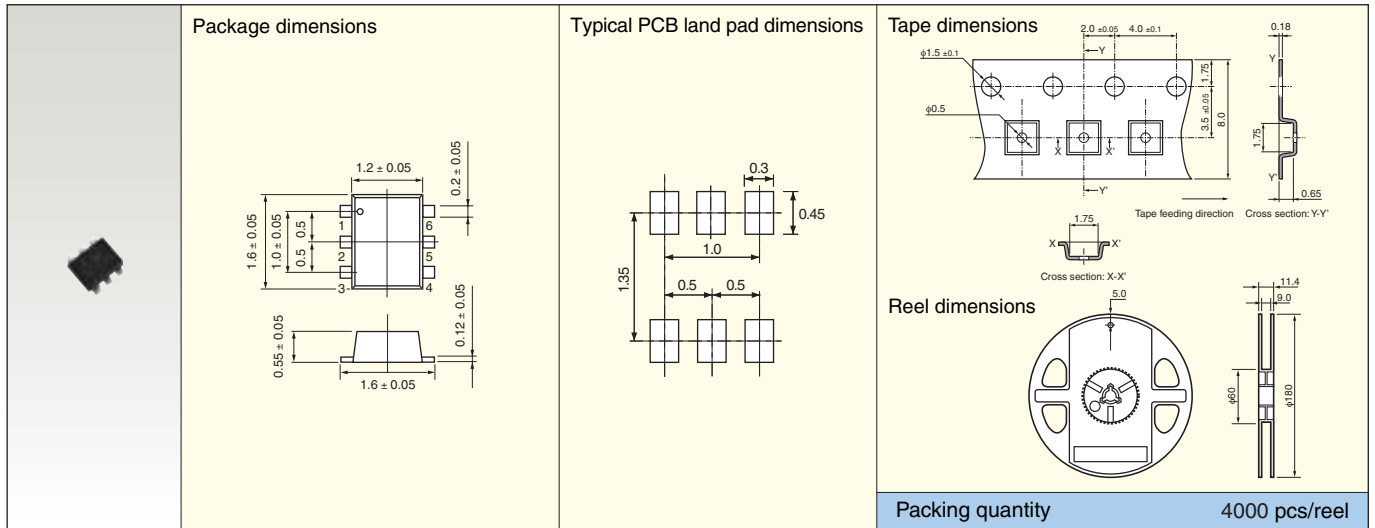

■ US6 (SOT-363)(SC-88)

Unit: mm

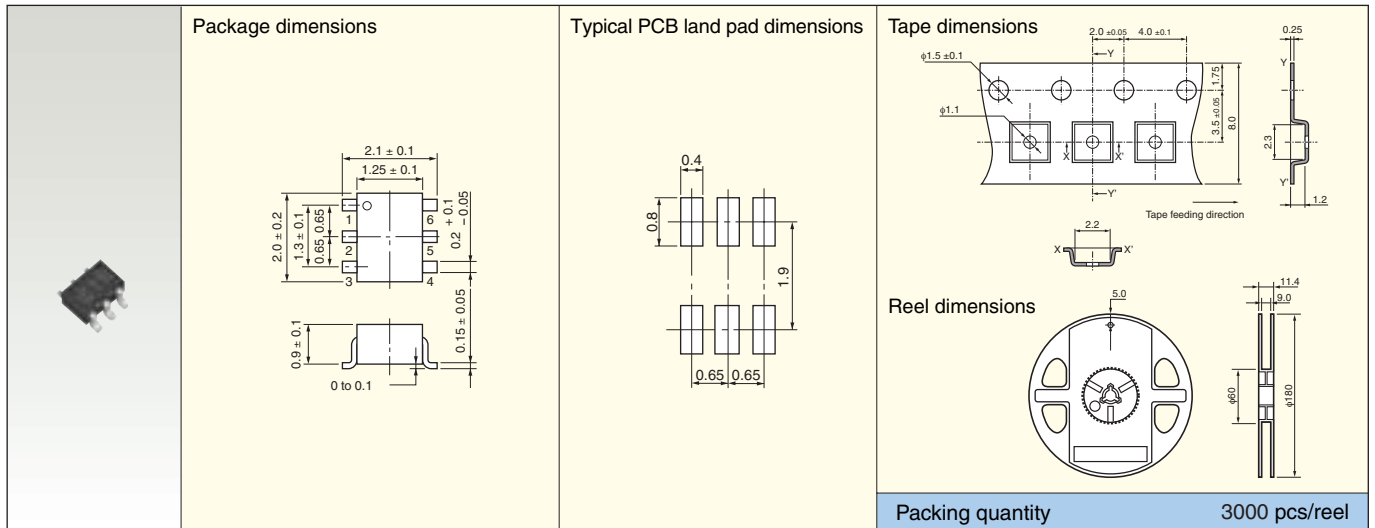

■ UF6

Unit: mm

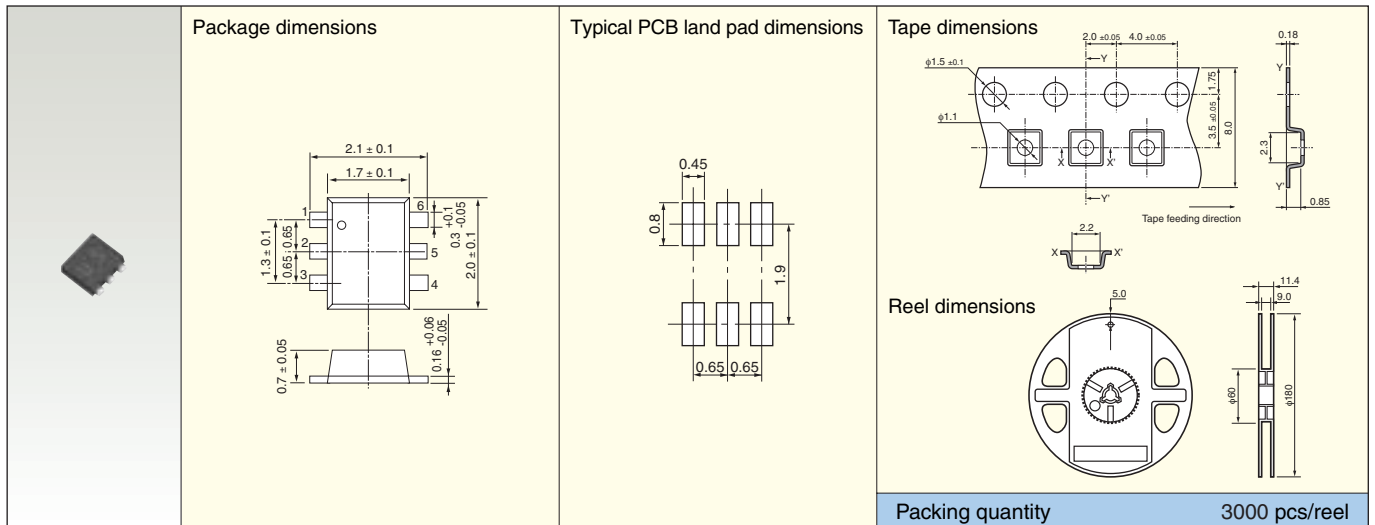

■ VS-6

Unit: mm



■ VS-8

Unit: mm



■ PS-8

Unit: mm

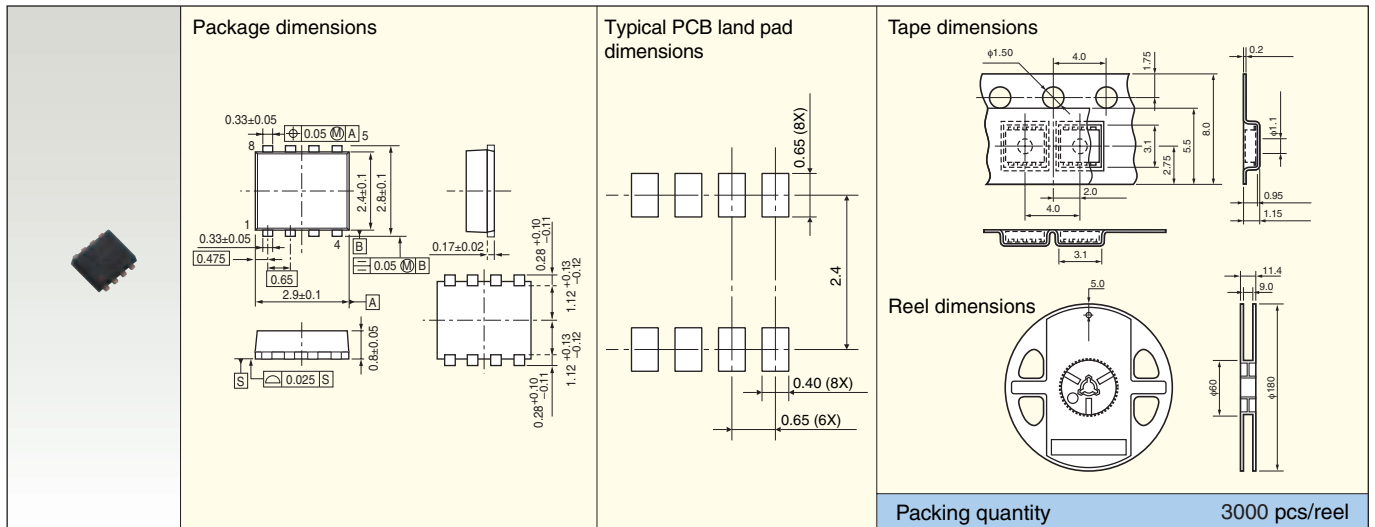

■ TSSOP Advance

Unit: mm



■ TSSOP-8

Unit: mm

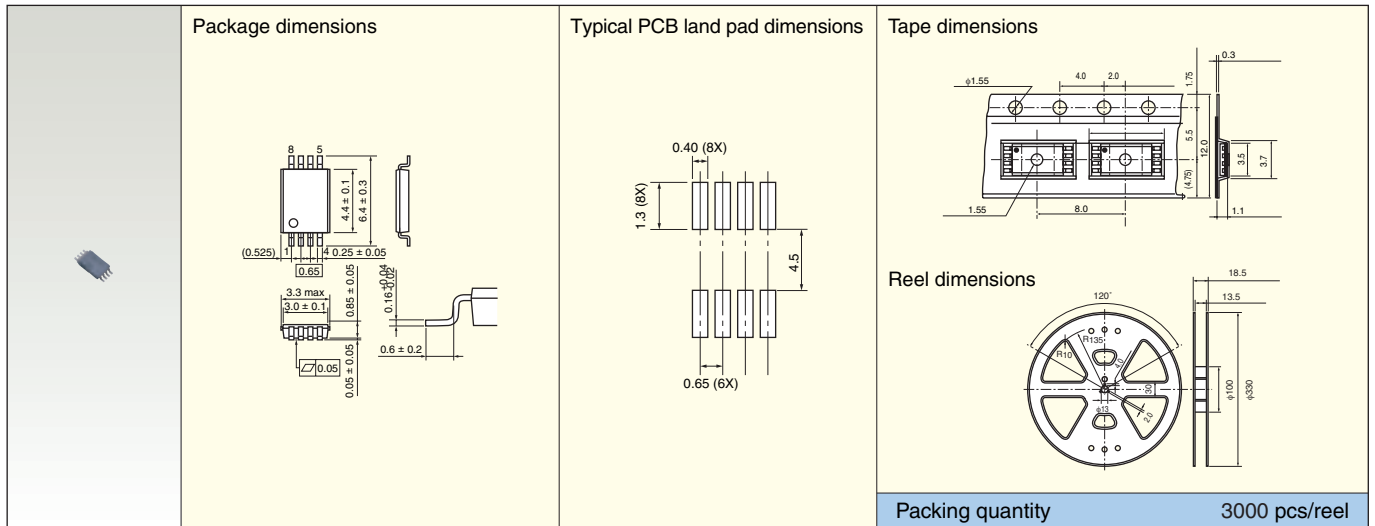

■ SOP-8

Unit: mm

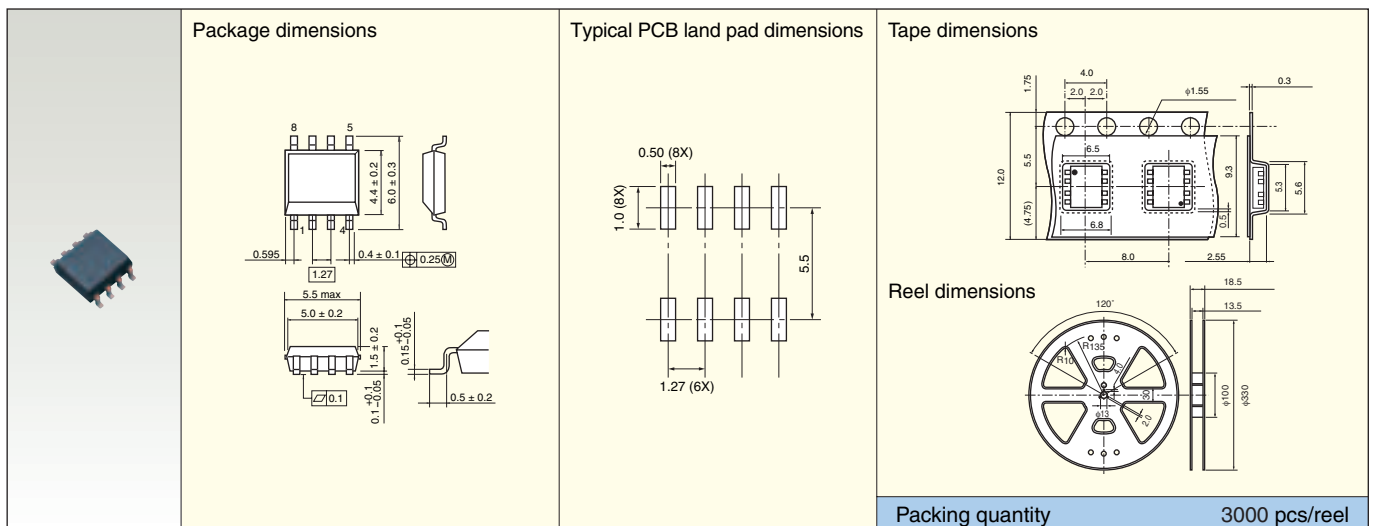

■ SOP Advance

Unit: mm



■ PW-Mini

Unit: mm



■ DP

Unit: mm



■ New PW-Mold

Unit: mm

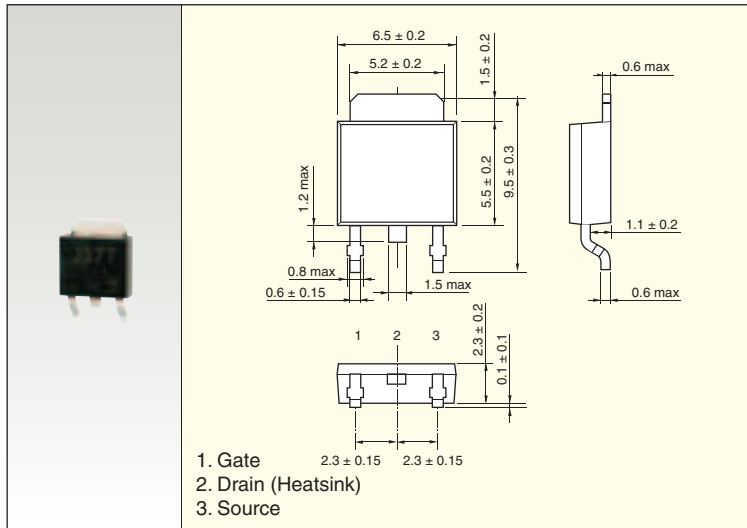

Tape dimensions

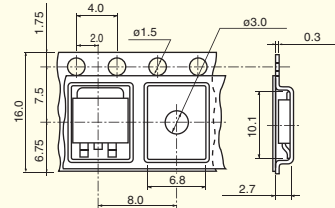

Reel dimensions

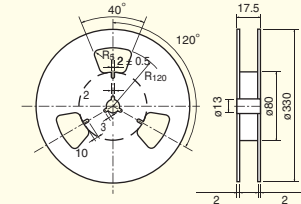

Packing quantity

2000 pcs/reel

■ DPAK

Unit: mm

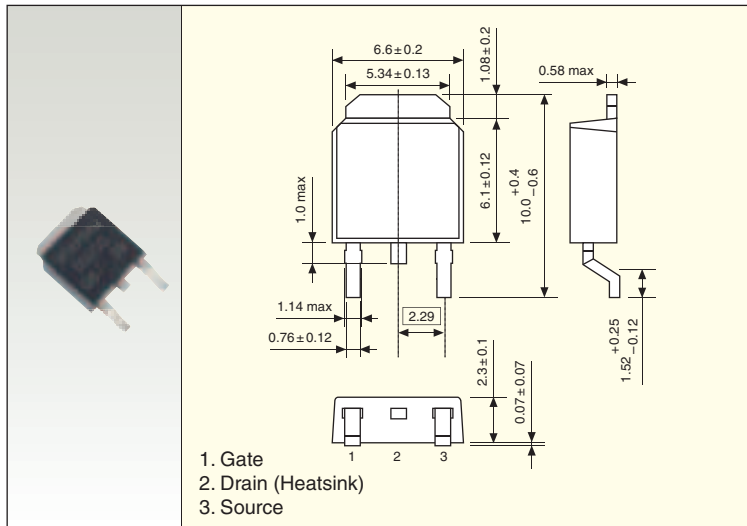

Tape dimensions

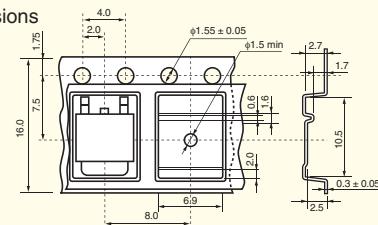

Reel dimensions

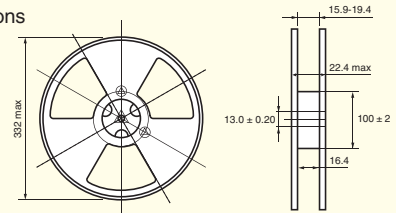

Packing quantity

2000 pcs/reel

■ TO-220SM

Unit: mm

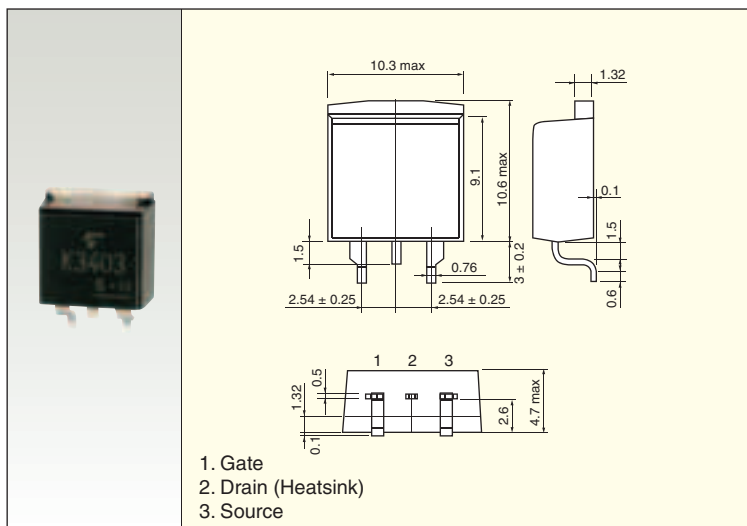

Tape dimensions

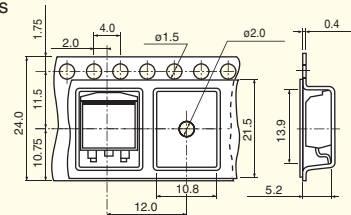

Reel dimensions

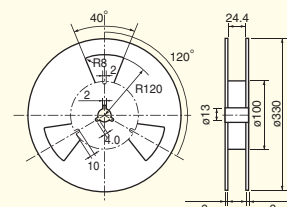

Packing quantity

1000 pcs/reel

TO-220SM(W)

Unit: mm

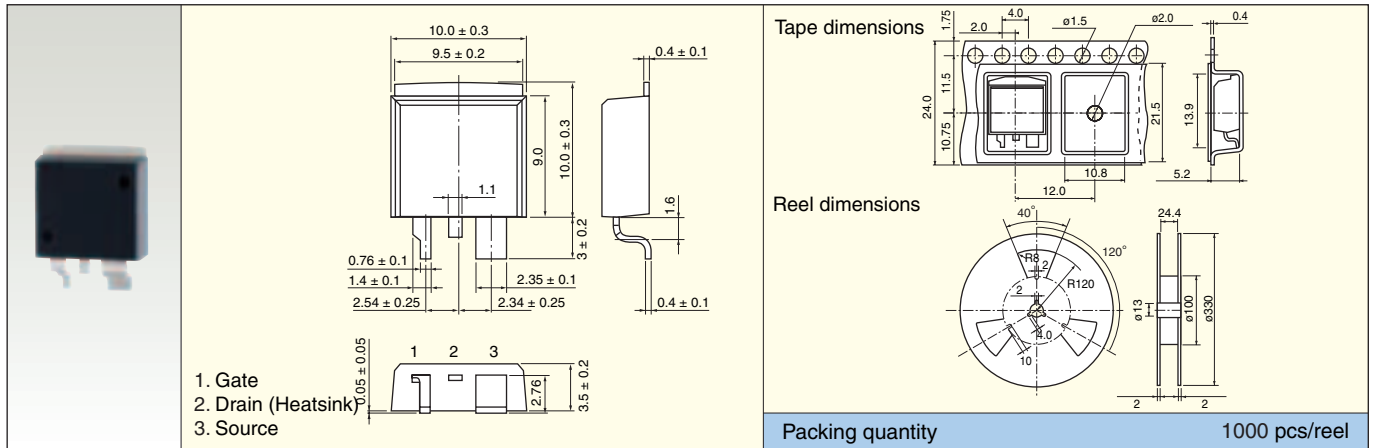

TFP

Unit: mm

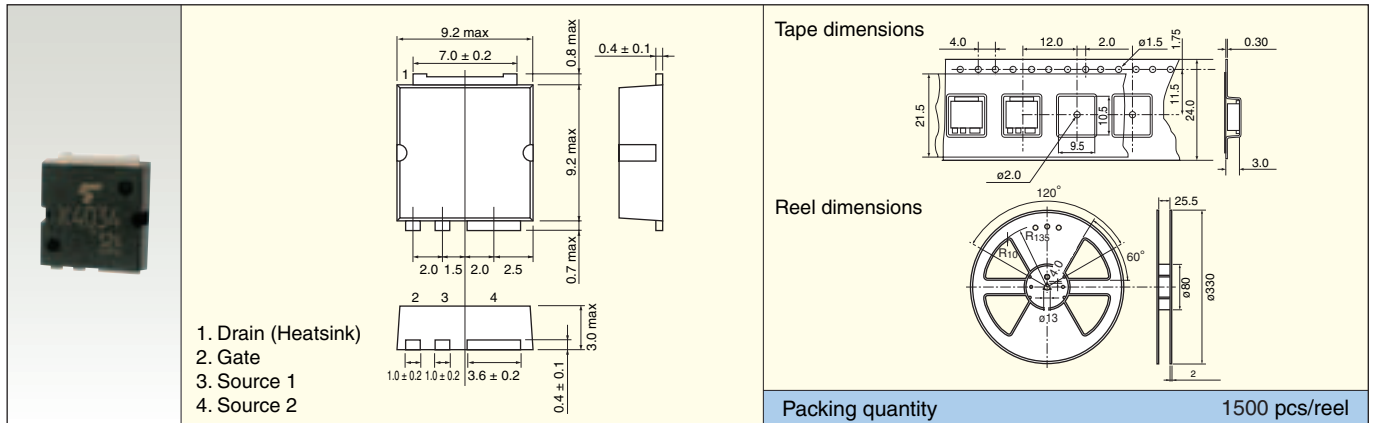

9-2 Through-Hole Packages

LSTM

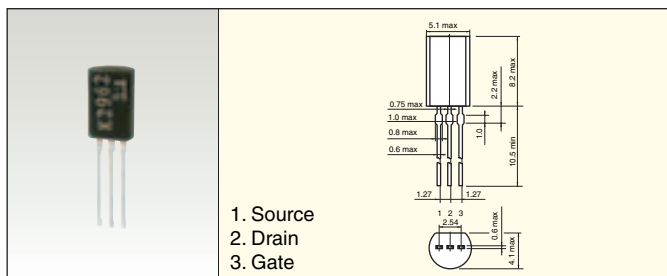

PW-Mold (Straight)

Unit: mm

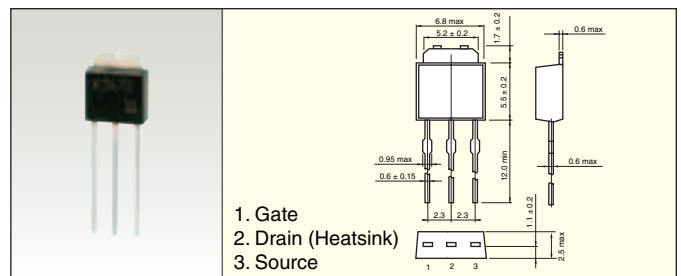

New PW-Mold2

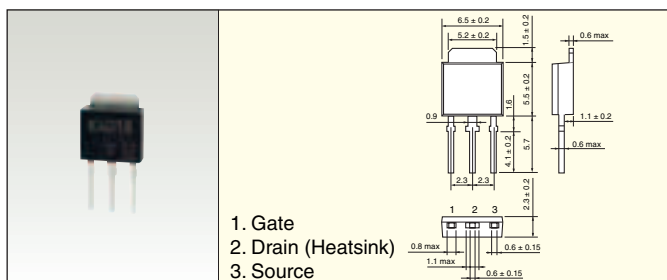

DP (Straight)

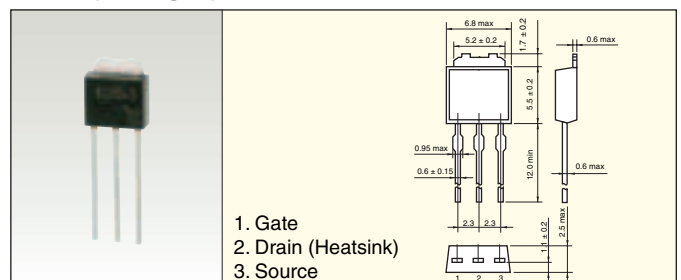

■ TPS

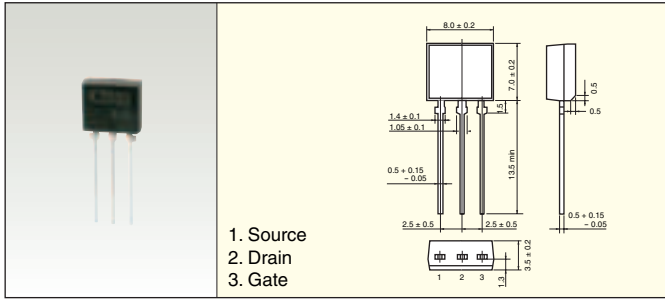

■ TO-220AB

Unit: mm

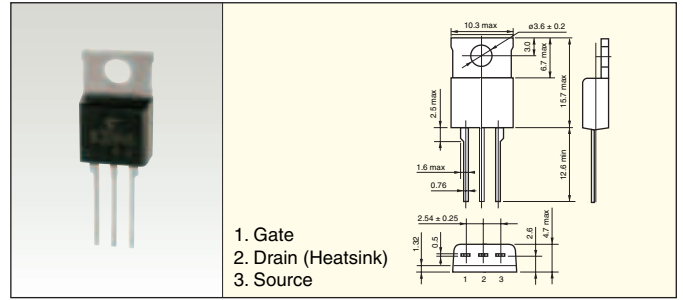

■ TO-220(W)

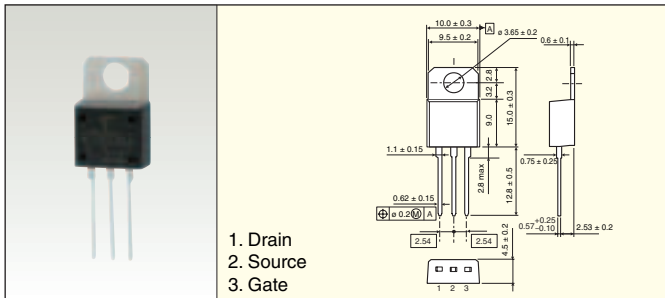

■ TO-220NIS

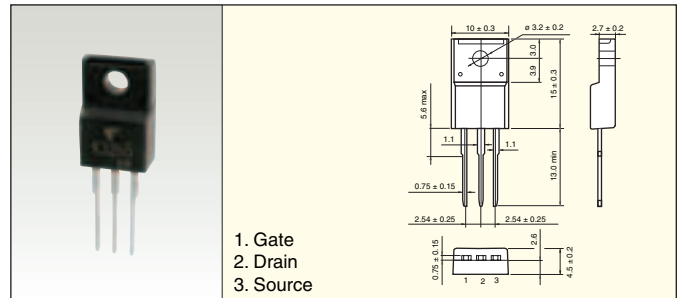

■ TO-220SIS

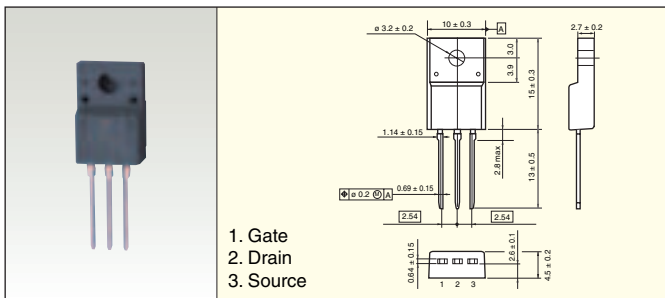

■ TO-220FL

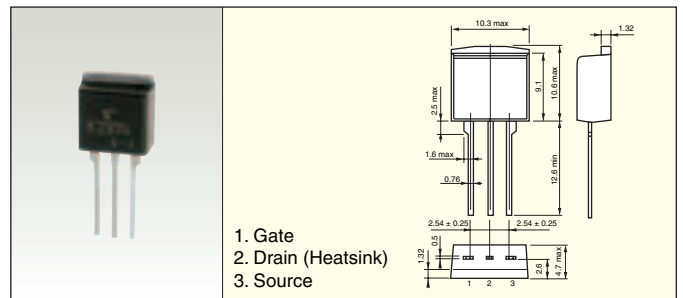

■ TO-3P(N)

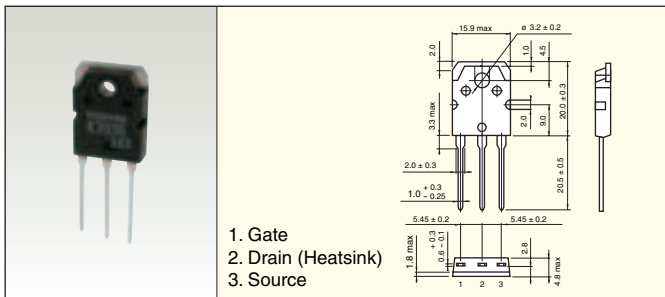

■ TO-3P(N)IS

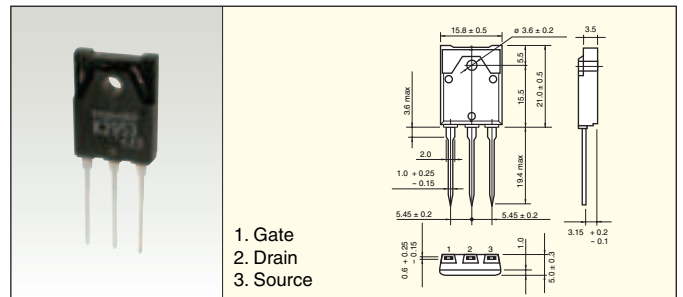

■ TO-3P(L)

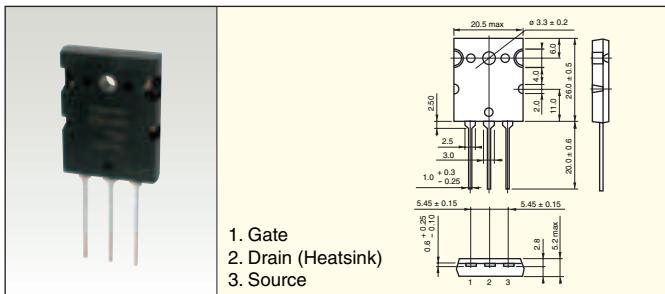

Toshiba America**Electronic Components, Inc.**

- Headquarters-Irvine, CA
Tel: (949)623-2900 Fax: (949)474-1330
- Buffalo Grove (Chicago)
Tel: (847)484-2400 Fax: (847)541-7287
- Duluth, GA (Atlanta)
Tel: (770)931-3363 Fax: (770)931-7602
- San Jose Engineering Center, CA
Tel: (408)526-2400 Fax: (408)526-2410
- Wixom (Detroit)
Tel: (248)347-2607 Fax: (248)347-2602

Toshiba Electronics do Brasil Ltda.

Tel: (011)2539-6681 Fax: (011)2539-6675

Toshiba India Private Ltd.

Tel: (011)2331-8422 Fax: (011)2371-4603

Toshiba Electronics Europe GmbH

- Düsseldorf Head Office
Tel: (0211)5296-0 Fax: (0211)5296-400
- France Branch
Tel: (1)48-12-48-12 Fax: (1)48-94-51-15
- Italy Branch
Tel: (039)68701 Fax: (039)6870205
- Spain Branch
Tel: (91)660-6798 Fax: (91)660-6799
- U.K. Branch
Tel: (0870)060-2370 Fax: (01252)53-0250
- Sweden Branch
Tel: (08)704-0900 Fax: (08)80-8459

Toshiba Electronics Asia (Singapore) Pte. Ltd.

Tel: (6278)5252 Fax: (6271)5155

Toshiba Electronics Service (Thailand) Co., Ltd.

Tel: (02)501-1635 Fax: (02)501-1638

Toshiba Electronics Trading (Malaysia) Sdn. Bhd.

- Kuala Lumpur Head Office
Tel: (03)5631-6311 Fax: (03)5631-6307
- Penang Office
Tel: (04)226-8523 Fax: (04)226-8515

Toshiba Electronics Philippines, Inc.

Tel: (02)750-5510 Fax: (02)750-5511

Toshiba Electronics Asia, Ltd.

- Hong Kong Head Office
Tel: 2375-6111 Fax: 2375-0969
- Beijing Office
Tel: (010)6590-8796 Fax: (010)6590-8791
- Chengdu Office
Tel: (028)8675-1773 Fax: (028)8675-1065
- Qingdao Office
Tel: (532)8579-3328 Fax: (532)8579-3329

Toshiba Electronics Shenzhen Co., Ltd.

Tel: (0755)2399-6897 Fax: (0755)2399-5573

Toshiba Electronics (Shanghai) Co., Ltd.

- Shanghai Head Office
Tel: (021)6841-0666 Fax: (021)6841-5002
- Hangzhou Office
Tel: (0571)8717-5004 Fax: (0571)8717-5013
- Nanjing Office
Tel: (025)8689-0070 Fax: (025)8689-0125

Toshiba Electronics (Dalian) Co., Ltd.

Tel: (0411)8368-6882 Fax: (0411)8369-0822

Tsurong Xiamen Xiangyu Trading Co., Ltd.

Tel: (0592)226-1398 Fax: (0592)226-1399

Toshiba Electronics Korea Corporation

- Seoul Head Office
Tel: (02)3484-4334 Fax: (02)3484-4302
- Daegu Office
Tel: (053)428-7610 Fax: (053)428-7617

Toshiba Electronics Taiwan Corporation

- Taipei Head Office
Tel: (02)2508-9988 Fax: (02)2508-9999
- Kaohsiung Office
Tel: (07)237-0826 Fax: (07)236-0046

- ▶ Toshiba Corporation, and its subsidiaries and affiliates (collectively "TOSHIBA"), reserve the right to make changes to the information in this document, and related hardware, software and systems (collectively "Product") without notice.
- ▶ This document and any information herein may not be reproduced without prior written permission from TOSHIBA. Even with TOSHIBA's written permission, reproduction is permissible only if reproduction is without alteration/omission.
- ▶ Though TOSHIBA works continually to improve Product's quality and reliability, Product can malfunction or fail. Customers are responsible for complying with safety standards and for providing adequate designs and safeguards for their hardware, software and systems which minimize risk and avoid situations in which a malfunction or failure of Product could cause loss of human life, bodily injury or damage to property, including data loss or corruption. Before creating and producing designs and using, customers must also refer to and comply with (a) the latest versions of all relevant TOSHIBA information, including without limitation, this document, the specifications, the data sheets and application notes for Product and the precautions and conditions set forth in the "TOSHIBA Semiconductor Reliability Handbook" and (b) the instructions for the application that Product will be used with or for. Customers are solely responsible for all aspects of their own product design or applications, including but not limited to (a) determining the appropriateness of the use of this Product in such design or applications; (b) evaluating and determining the applicability of any information contained in this document, or in charts, diagrams, programs, algorithms, sample application circuits, or any other referenced documents; and (c) validating all operating parameters for such designs and applications. **TOSHIBA ASSUMES NO LIABILITY FOR CUSTOMERS' PRODUCT DESIGN OR APPLICATIONS.**
- ▶ Product is intended for use in general electronics applications (e.g., computers, personal equipment, office equipment, measuring equipment, industrial robots and home electronics appliances) or for specific applications as expressly stated in this document. Product is neither intended nor warranted for use in equipment or systems that require extraordinarily high levels of quality and/or reliability and/or a malfunction or failure of which may cause loss of human life, bodily injury, serious property damage or serious public impact ("Unintended Use"). Unintended Use includes, without limitation, equipment used in nuclear facilities, equipment used in the aerospace industry, medical equipment, equipment used for automobiles, trains, ships and other transportation, traffic signaling equipment, equipment used to control combustions or explosions, safety devices, elevators and escalators, devices related to electric power, and equipment used in finance-related fields. Do not use Product for Unintended Use unless specifically permitted in this document.
- ▶ Do not disassemble, analyze, reverse-engineer, alter, modify, translate or copy Product, whether in whole or in part.
- ▶ Product shall not be used for or incorporated into any products or systems whose manufacture, use, or sale is prohibited under any applicable laws or regulations.
- ▶ The information contained herein is presented only as guidance for Product use. No responsibility is assumed by TOSHIBA for any infringement of patents or any other intellectual property rights of third parties that may result from the use of Product. No license to any intellectual property right is granted by this document, whether express or implied, by estoppel or otherwise.
- ▶ **ABSENT A WRITTEN SIGNED AGREEMENT, EXCEPT AS PROVIDED IN THE RELEVANT TERMS AND CONDITIONS OF SALE FOR PRODUCT, AND TO THE MAXIMUM EXTENT ALLOWABLE BY LAW, TOSHIBA (1) ASSUMES NO LIABILITY WHATSOEVER, INCLUDING WITHOUT LIMITATION, INDIRECT, CONSEQUENTIAL, SPECIAL, OR INCIDENTAL DAMAGES OR LOSS, INCLUDING WITHOUT LIMITATION, LOSS OF PROFITS, LOSS OF OPPORTUNITIES, BUSINESS INTERRUPTION AND LOSS OF DATA, AND (2) DISCLAIMS ANY AND ALL EXPRESS OR IMPLIED WARRANTIES AND CONDITIONS RELATED TO SALE, USE OF PRODUCT, OR INFORMATION, INCLUDING WARRANTIES OR CONDITIONS OF MERCHANTABILITY, FITNESS FOR A PARTICULAR PURPOSE, ACCURACY OF INFORMATION, OR NONINFRINGEMENT.**
- ▶ Do not use or otherwise make available Product or related software or technology for any military purposes, including without limitation, for the design, development, use, stockpiling or manufacturing of nuclear, chemical, or biological weapons or missile technology products (mass destruction weapons). Product and related software and technology may be controlled under the Japanese Foreign Exchange and Foreign Trade Law and the U.S. Export Administration Regulations. Export and re-export of Product or related software or technology are strictly prohibited except in compliance with all applicable export laws and regulations.
- ▶ Please contact your TOSHIBA sales representative for details as to environmental matters such as the RoHS compatibility of Product. Please use Product in compliance with all applicable laws and regulations that regulate the inclusion or use of controlled substances, including without limitation, the EU RoHS Directive. TOSHIBA assumes no liability for damages or losses occurring as a result of noncompliance with applicable laws and regulations.

TOSHIBA**TOSHIBA CORPORATION**
Semiconductor CompanyWebsite: <http://www.semicon.toshiba.co.jp/eng>



©2009 TOSHIBA CORPORATION

Previous edition: BCE0082A
2009-9(1k)SO-DQ





MOSFETS

Looking for pricing, stock, or lifecycle information?

Click below to explore more details on WIN SOURCE:

-  [View K3566 on WIN SOURCE](#)
-  [Toshiba Semiconductor and Storage Information](#)

Optimize Your Supply Chain with WIN SOURCE Solutions

-  Global Sourcing Solution
-  Obsolete Management
-  Cost Control Management
-  Shortage Management
-  Alternative Solution
-  Excess Inventory Management