



**THE DATASHEET OF  
XUX0ARCTT16T**





## Main

Range of Product	Telemecanique Photoelectric sensors XU
Series name	General purpose multimode
Electronic sensor type	Photo-electric sensor
Sensor name	XUK
Sensor design	Compact 50 x 50
Detection system	Multimode
Material	Plastic
Type of output signal	Discrete
Supply circuit type	DC
Wiring Technique	3-wire
Discrete output type	PNP or NPN
Discrete output function	1 NO or 1 NC programmable
Electrical connection	1 male connector M12, 4 pins
Product Specific Application	-
Emission	Infrared diffuse Infrared diffuse with background suppression Infrared thru beam Red polarised reflex
[Sn] nominal sensing distance	13.12 Ft (4 m) polarised reflex need reflector XUZC50 98.43 Ft (30 m) thru beam need a transmitter XUK0AKSAM12T 0.92 Ft (0.28 m) diffuse with background suppression 2.62 ft (0.8 m) diffuse

## Complementary

Enclosure Material	PBT
Lens material	PMMA
Maximum sensing distance	114.83 Ft (35 m) thru beam 0.92 Ft (0.28 m) diffuse with background suppression 3.94 Ft (1.2 m) diffuse 18.70 ft (5.7 m) polarised reflex
Output Type	Solid state
Add on output	With alarm output, <= 50 mA overload and short-circuit protection
Status LED	1 LED green)supply 1 LED red)instability 1 LED yellow)output state
[Us] rated supply voltage	12...24 V DC reverse polarity protection
Supply voltage limits	10...36 V DC
Switching capacity in mA	<= 100 mA overload and short-circuit protection)
Switching frequency	<= 250 Hz
Maximum voltage drop	<1.5 V closed state)
Current consumption	<= 35 mA no-load
Maximum delay first up	200 ms
Maximum delay response	2 ms
Maximum delay recovery	2 ms
Setting-up	Self-teaching
Depth	1.97 in (50 mm)
Height	1.97 in (50 mm)

Width	0.71 in (18 mm)
Net Weight	0.20 lb(US) (0.09 kg)

## Environment

Product Certifications	CE CSA UL
Ambient air temperature for operation	-13...131 °F (-25...55 °C)
Ambient Air Temperature for Storage	-40...158 °F (-40...70 °C)
Vibration resistance	7 gn +/- 1.5 mm 10...55 Hz) IEC 60068-2-6
Shock resistance	30 gn 11 ms) IEC 60068-2-27
IP degree of protection	IP65 double insulation IEC 60529

## Ordering and shipping details

Category	22481 - SENSORS, PHOTOELECTRIC
Discount Schedule	DS2
GTIN	3389110160406
Nbr. of units in pkg.	1
Package weight(Lbs)	2.43 oz (69 g)
Returnability	Yes
Country of origin	ID

## Packing Units

Unit Type of Package 1	PCE
Package 1 Height	1.97 in (5 cm)
Package 1 width	2.76 in (7 cm)
Package 1 Length	3.94 in (10 cm)
Unit Type of Package 2	S01
Number of Units in Package 2	22
Package 2 Weight	4.05 lb(US) (1.836 kg)
Package 2 Height	5.91 in (15 cm)
Package 2 width	5.91 in (15 cm)
Package 2 Length	15.75 in (40 cm)

## Offer Sustainability

Sustainable offer status	Green Premium product
California proposition 65	WARNING: This product can expose you to chemicals including: Diisononyl phthalate (DINP), which is known to the State of California to cause cancer, and Di-isodecyl phthalate (DIDP), which is known to the State of California to cause birth defects or other reproductive harm. For more information go to <a href="http://www.P65Warnings.ca.gov">www.P65Warnings.ca.gov</a>
REACH Regulation	<a href="#">REACH Declaration</a>
EU RoHS Directive	Pro-active compliance (Product out of EU RoHS legal scope) <a href="#">EU RoHS Declaration</a>
Mercury free	Yes
RoHS exemption information	<a href="#">Yes</a>
Environmental Disclosure	<a href="#">Product Environmental Profile</a>
Circularity Profile	<a href="#">End Of Life Information</a>

## Contractual warranty

Warranty	18 months
----------	-----------

Dimensions

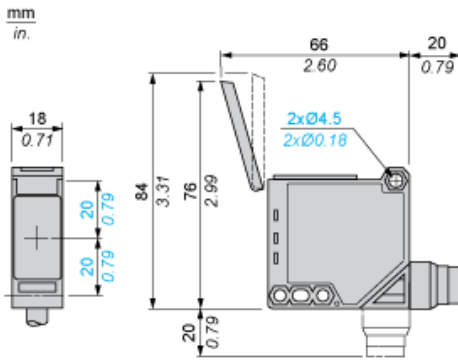

---

## Mounting and Clearance

---

### Possible Orientation of Elbowed Connector

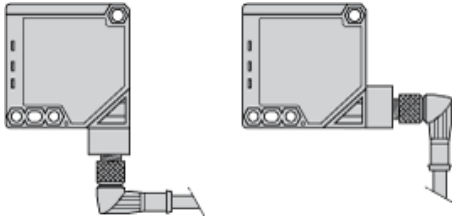

## Wiring Schemes

### M12 Connector

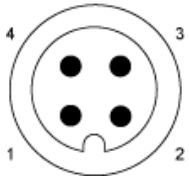

- 1 : (+)
- 2 : Alarm input
- 3 : (-)
- 4 : OUT/Output

### PNP Output

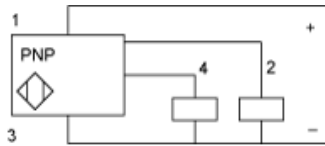

### NPN Output

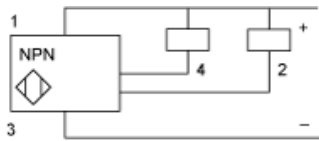

Detection Curves

With Thru-beam Accessory (Thru-beam)

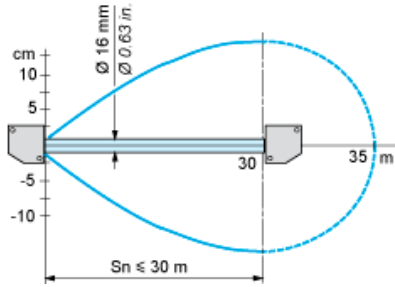

Without Accessory (Diffuse)

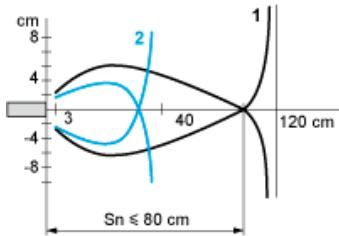

1 : White 90%  
2 : Grey 18%  
Object 10 x 10 cm

Without Accessory (Diffuse with background suppression)

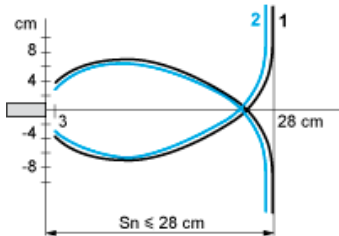

1 : White 90%  
2 : Grey 18%  
Object 10 x 10 cm

With reflector (Polarised reflex)

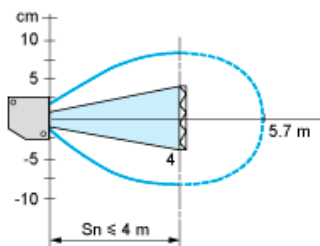

With reflector XUZC50

## Variation of Usable Sensing Distance $S_u$ (Without accessory, with adjustable background suppression)

Teach Mode at Minimum

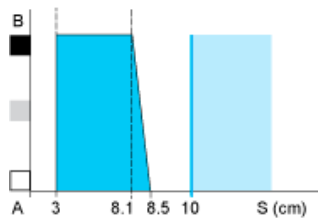

Teach Mode at Maximum

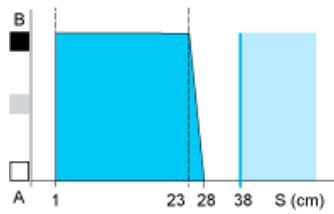

- (1) Black
- (2) Grey
- (3) White
- (4) Sensing range
- (5) Non sensing zone (matt surfaces)

A-B : Object reflection coefficient

- (1) Black 6%
- (2) Grey 18%
- (3) White 90%
- (4) Sensing range
- (5) Non sensing zone (matt surfaces)

## Looking for pricing, stock, or lifecycle information?

Click below to explore more details on WIN SOURCE:

 [View XUX0ARCTT16T on WIN SOURCE](#)

 [Manufacturer Information](#)

## Optimize Your Supply Chain with WIN SOURCE Solutions

-  Global Sourcing Solution
-  Obsolete Management
-  Cost Control Management
-  Shortage Management
-  Alternative Solution
-  Excess Inventory Management