



THE DATASHEET OF
1452233



Sensor/actuator box - SACB-6/12-L-C SCO P - 1452835

Please be informed that the data shown in this PDF Document is generated from our Online Catalog. Please find the complete data in the user's documentation. Our General Terms of Use for Downloads are valid (<http://download.phoenixcontact.com>)



Sensor/actuator box, Connection method: M12-SPEEDCON-socket Plastic, Number of slots: 6, Number of positions: 5, Slot assignment: Double, Status indication: Yes, pnp; Master cable connection: Pluggable screw connection 180°, Shielding: No

Product Features

- ✓ Safety in the field, thanks to molded housing and high degree of protection
- ✓ Flexible, distributed bundling of signals in one master cable
- ✓ Convenient: increased machine availability thanks to quick and easy diagnostics
- ✓ Save space: distributor box with double occupancy for two sensors in one slot
- ✓ Save time, thanks to installation with SPEEDCON fast locking system
- ✓ Flexible: distributor box with connector hood for on-site assembly



Key commercial data

Packing unit	1 PCE
Custom tariff number	85444290
Country of origin	Poland

Technical data

General

Rated voltage	24 V DC
Max. operating voltage U_{max}	30 V DC
Current carrying capacity per I/O signal	2 A
Current carrying capacity per slot	4 A
Total rated current	10 A
Number of positions	5
Number of slots	6
Inflammability class according to UL 94	V0
Sensor/actuator connection system	M12-SPEEDCON-socket

Sensor/actuator box - SACB-6/12-L-C SCO P - 1452835

Technical data

Ambient conditions

Degree of protection	IP65
	IP67
Ambient temperature (operation)	-25 °C ... 80 °C

Local diagnostics function

Local diagnostics	Supply voltage Green LED
	Status display I/O Yellow LED

Master cable data/connection data

Connection method	Pluggable screw connection
Conductor cross section min. (signal)	0.14 mm ²
Conductor cross section max. (signal)	1.5 mm ²
Conductor cross section AWG min. (signal)	26
Conductor cross section AWG max. (signal)	16
Stripping length (signal)	7 mm
Conductor cross section min. (energy)	0.14 mm ²
Conductor cross section max. (energy)	1.5 mm ²
Conductor cross section AWG min. (energy)	26
Conductor cross section AWG max. (energy)	16
External cable diameter min.	7 mm
External cable diameter max.	12 mm
Stripping length	50 mm (Master cable)
Tightening torque, cover screw	1 Nm
Tightening torque, union nut	2.5 Nm
Tightening torque slot sensor/actuator cable	0.4 Nm

Insulation material

Housing material	PBT
Material of the moulding mass	PUR
Contact material	Cu alloy
Contact surface material	Gold-plated
Contact carrier material	PA
Material of contact, master cable side	CU alloy
Material of contact surface, master cable side	Sn
Material of the contact carrier on the master cable side	PA
Material of threaded sleeve	PBT
Material, O-ring	NBR
Sealing material	NBR (Connector hood)

Sensor/actuator box - SACB-6/12-L-C SCO P - 1452835

Technical data

Pin assignment

Slot/position = Wire color or connection	1 / 4 (A) = WH
	1 / 2 (B) = GY/PK
	2 / 4 (A) = GN
	2 / 2 (B) = RD/BU
	3 / 4 (A) = YE
	3 / 2 (B) = WH/GN
	4 / 4 (A) = GY
	4 / 2 (B) = BN/GN
	5 / 4 (A) = PK
	5 / 2 (B) = WH/YE
	6 / 4 (A) = RD
	6 / 2 (B) = YE/BN
	1-4 / 1 (+ 24 V) = BN
	1-6 / 3 (0 V) = BU
	1-6 / 5 (PE) = GN/YE

Classifications

eCl@ss

eCl@ss 4.0	27140815
eCl@ss 4.1	27140815
eCl@ss 5.0	27143423
eCl@ss 5.1	27143423
eCl@ss 6.0	27143423
eCl@ss 7.0	27449001
eCl@ss 8.0	27279219

ETIM

ETIM 4.0	EC002585
ETIM 5.0	EC002585

UNSPSC

UNSPSC 6.01	31261501
UNSPSC 7.0901	31261501
UNSPSC 11	31261501
UNSPSC 12.01	31261501
UNSPSC 13.2	31261501

Sensor/actuator box - SACB-6/12-L-C SCO P - 1452835

Approvals

Approvals

Approvals

UL Recognized / cUL Recognized / GOST / cULus Recognized

Ex Approvals

Approvals submitted

Approval details

UL Recognized	
Nominal voltage UN	24 V

cUL Recognized	
Nominal voltage UN	24 V

GOST	
------	--

cULus Recognized	
------------------	--

Accessories

Accessories

Cable by the meter

Sensor/actuator box - SACB-6/12-L-C SCO P - 1452835

Accessories

Master cable ring - SACB-12X0,5/ 3X1,0-50,0 PUR - 1503360



Master cable for sensor/actuator boxes, with PE conductor, unshielded, material PUR/PVC, 15-pos., 12 x 0.50 mm² and 3 x 1.00 mm², length: 50 m

Device marking

Contact marker – zack marker strip - SS-ZB 17,5 WH - 0804963



Contact marker – zack marker strip, Strip, white, Unlabeled, Can be labeled with: Plotter, Mounting type: Snap into flat marker groove, Lettering field: 17.5 x 8 mm

Contact marker – zack marker strip - SS-ZB 17,5 YE - 0804976



Contact marker – zack marker strip, Strip, yellow, Unlabeled, Can be labeled with: Plotter, Mounting type: Snap into flat marker groove, Lettering field: 17.5 x 8 mm

Labeled device marker

Contact marker – zack marker strip - SS-ZB 17,5 WH CUS - 0824468



Contact marker – zack marker strip, Can be ordered: Strip, white, Labeled according to customer specifications, Mounting type: Snap into flat marker groove, Lettering field: 17.5 x 8 mm

Contact marker – zack marker strip - SS-ZB 17,5 YE CUS - 0824469



Contact marker – zack marker strip, Can be ordered: Strip, yellow, Labeled according to customer specifications, Mounting type: Snap into flat marker groove, Lettering field: 17.5 x 8 mm

Sensor/actuator box - SACB-6/12-L-C SCO P - 1452835

Accessories

Protective cap

Screw plug - PROT-MS SCO - 1553129



M12 screw plug with SPEEDCON quick locking for unoccupied M12 sockets of the sensor/actuator cables, boxes and flush-type connectors

Screwdriver tools

Tool - SACC BIT M12-D20 - 1208445



Nut for assembling SACC M12 connectors for free assembly, excluding M12 connectors with QUICKON fast connection technology, for 4 mm hexagonal drive

Philips screwdriver - SZK PZ2 VDE - 1206463



Screwdriver, PZ crosshead, VDE insulated, size: PZ 2 x 100 mm, 2-component grip, with non-slip grip

Tool - SAC BIT HOOD-W 24 - 1212486



Nut for assembling pressure nuts with 24 mm wrench size, for 4 mm hexagonal drive

Sensor/actuator box - SACB-6/12-L-C SCO P - 1452835

Accessories

Adapter insert - TSD-M SAC-BIT ADAPTER - 1212600



Adapter bit for TSD-M...torque tools, E6.3-1/4" drive with 4 mm hexagon to accommodate SAC bits

Torque tool

Torque screwdriver - TSD 04 SAC - 1208429



Torque screwdriver, with preset torque of 0.4 Nm and 4 mm hexagonal drive for M12 connectors

Torque screwdriver - TSD-M 1,2NM - 1212224



Torque screw driver, accuracy as per EN ISO 6789 standard, adjustable from 0.3 - 1.2 Nm

Torque screwdriver - TSD 25 SAC - 1212315



Torque screwdriver, with preset torque of 2.5 Nm and 4 mm hexagonal drive for the pressure nut of the connector hood

Torque screwdriver - TSD-M 3NM - 1212225



Torque screw driver, accuracy as per EN ISO 6789 standard, adjustable from 1.2 - 3 Nm

Sensor/actuator box - SACB-6/12-L-C SCO P - 1452835

Drawings

Schematic diagram

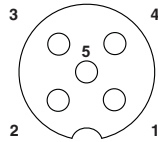

M12 slot, socket, 5-pos.

Circuit diagram

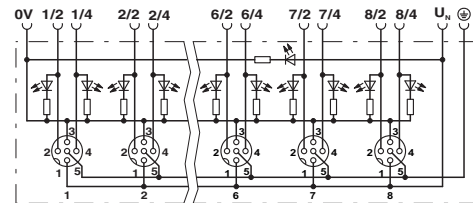

Dimensioned drawing

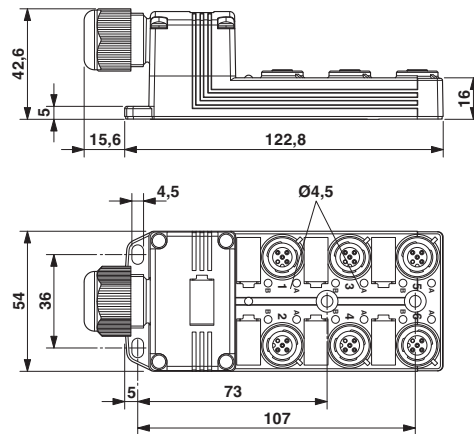

Looking for pricing, stock, or lifecycle information?

Click below to explore more details on WIN SOURCE:

 [View 1452233 on WIN SOURCE](#)

 [Phoenix Contact Information](#)

Optimize Your Supply Chain with WIN SOURCE Solutions

-  Global Sourcing Solution
-  Obsolete Management
-  Cost Control Management
-  Shortage Management
-  Alternative Solution
-  Excess Inventory Management