



# 2N6667, 2N6668

## Darlington Silicon Power Transistors

Designed for general-purpose amplifier and low speed switching applications.

- High DC Current Gain –  
 $h_{FE} = 3500$  (Typ) @  $I_C = 4.0$  Adc
- Collector–Emitter Sustaining Voltage – @ 200 mAdc  
 $V_{CEO(sus)} = 60$  Vdc (Min) – 2N6667  
 $= 80$  Vdc (Min) – 2N6668
- Low Collector–Emitter Saturation Voltage –  
 $V_{CE(sat)} = 2.0$  Vdc (Max) @  $I_C = 5.0$  Adc
- Monolithic Construction with Built–In Base–Emitter Shunt Resistors
- TO–220AB Compact Package
- Complementary to 2N6387, 2N6388
- These Devices are Pb–Free and are RoHS Compliant\*

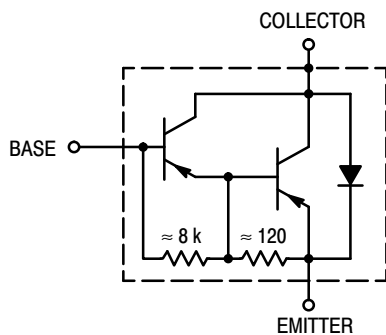

Figure 1. Darlington Schematic



**ON Semiconductor®**

[www.onsemi.com](http://www.onsemi.com)

**PNP SILICON  
DARLINGTON  
POWER TRANSISTORS  
10 A, 60–80 V, 65 W**

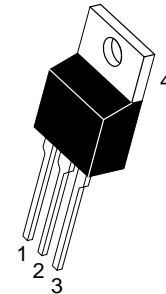

TO-220  
CASE 221A  
STYLE 1

### MARKING DIAGRAM

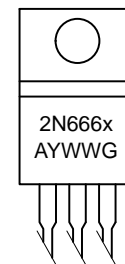

x = 7 or 8  
A = Assembly Location  
Y = Year  
WW = Work Week  
G = Pb–Free Package

### ORDERING INFORMATION

Device	Package	Shipping
2N6667G	TO–220 (Pb–Free)	50 Units/Rail
2N6668G	TO–220 (Pb–Free)	50 Units/Rail

\*For additional information on our Pb–Free strategy and soldering details, please download the ON Semiconductor Soldering and Mounting Techniques Reference Manual, SOLDERRM/D.

## 2N6667, 2N6668

### MAXIMUM RATINGS (Note 1)

Rating	Symbol	2N6667	2N6668	Unit
Collector–Emitter Voltage	$V_{CEO}$	60	80	Vdc
Collector–Base Voltage	$V_{CB}$	60	80	Vdc
Emitter–Base Voltage	$V_{EB}$	5.0		Vdc
Collector Current – Continuous – Peak	$I_C$	10 15		Adc
Base Current	$I_B$	250		mAdc
Total Device Dissipation @ $T_C = 25^\circ\text{C}$ Derate above $25^\circ\text{C}$	$P_D$	65 0.52		W W/ $^\circ\text{C}$
Total Device Dissipation @ $T_A = 25^\circ\text{C}$ Derate above $25^\circ\text{C}$	$P_D$	2.0 0.016		W W/ $^\circ\text{C}$
Operating and Storage Junction Temperature Range	$T_J, T_{stg}$	–65 to +150		$^\circ\text{C}$

Stresses exceeding those listed in the Maximum Ratings table may damage the device. If any of these limits are exceeded, device functionality should not be assumed, damage may occur and reliability may be affected.

### THERMAL CHARACTERISTICS

Characteristic	Symbol	Max	Unit
Thermal Resistance, Junction to Case	$R_{\theta JC}$	1.92	$^\circ\text{C}/\text{W}$
Thermal Resistance, Junction to Ambient	$R_{\theta JA}$	62.5	$^\circ\text{C}/\text{W}$

### ELECTRICAL CHARACTERISTICS (Note 1) ( $T_C = 25^\circ\text{C}$ unless otherwise noted)

Characteristic	Symbol	Min	Max	Unit
----------------	--------	-----	-----	------

#### OFF CHARACTERISTICS

Collector–Emitter Sustaining Voltage (Note 2) ( $I_C = 200\text{ mAdc}, I_B = 0$ )	2N6667 2N6668	$V_{CEO(sus)}$	60 80	– –	Vdc
Collector Cutoff Current ( $V_{CE} = 60\text{ Vdc}, I_B = 0$ ) ( $V_{CE} = 80\text{ Vdc}, I_B = 0$ )	2N6667 2N6668	$I_{CEO}$	– –	1.0 1.0	mAdc
Collector Cutoff Current ( $V_{CE} = 60\text{ Vdc}, V_{EB(off)} = 1.5\text{ Vdc}$ ) ( $V_{CE} = 80\text{ Vdc}, V_{EB(off)} = 1.5\text{ Vdc}$ ) ( $V_{CE} = 60\text{ Vdc}, V_{EB(off)} = 1.5\text{ Vdc}, T_C = 125^\circ\text{C}$ ) ( $V_{CE} = 80\text{ Vdc}, V_{EB(off)} = 1.5\text{ Vdc}, T_C = 125^\circ\text{C}$ )	2N6667 2N6668 2N6667 2N6668	$I_{CEX}$	– – – –	300 300 3.0 3.0	$\mu\text{Adc}$ mAdc
Emitter Cutoff Current ( $V_{BE} = 5.0\text{ Vdc}, I_C = 0$ )		$I_{EBO}$	–	5.0	mAdc

#### ON CHARACTERISTICS (Note 1)

DC Current Gain ( $I_C = 5.0\text{ Adc}, V_{CE} = 3.0\text{ Vdc}$ ) ( $I_C = 10\text{ Adc}, V_{CE} = 3.0\text{ Vdc}$ )		$h_{FE}$	1000 100	20000 –	–
Collector–Emitter Saturation Voltage ( $I_C = 5.0\text{ Adc}, I_B = 0.01\text{ Adc}$ ) ( $I_C = 10\text{ Adc}, I_B = 0.1\text{ Adc}$ )		$V_{CE(sat)}$	– –	2.0 3.0	Vdc
Base–Emitter Saturation Voltage ( $I_C = 5.0\text{ Adc}, I_B = 0.01\text{ Adc}$ ) ( $I_C = 10\text{ Adc}, I_B = 0.1\text{ Adc}$ )		$V_{BE(sat)}$	– –	2.8 4.5	Vdc

#### DYNAMIC CHARACTERISTICS

Current Gain – Bandwidth Product ( $I_C = 1.0\text{ Adc}, V_{CE} = 5.0\text{ Vdc}, f_{test} = 1.0\text{ MHz}$ )		$ h_{fe} $	20	–	–
Output Capacitance ( $V_{CB} = 10\text{ Vdc}, I_E = 0, f = 1.0\text{ MHz}$ )		$C_{ob}$	–	200	pF
Small–Signal Current Gain ( $I_C = 1.0\text{ Adc}, V_{CE} = 5.0\text{ Vdc}, f = 1.0\text{ kHz}$ )		$h_{fe}$	1000	–	–

Product parametric performance is indicated in the Electrical Characteristics for the listed test conditions, unless otherwise noted. Product performance may not be indicated by the Electrical Characteristics if operated under different conditions.

1. Indicates JEDEC Registered Data.
2. Pulse Test: Pulse Width  $\leq 300\ \mu\text{s}$ , Duty Cycle  $\leq 2\%$ .

# 2N6667, 2N6668

$R_B$  &  $R_C$  VARIED TO OBTAIN DESIRED CURRENT LEVELS

$D_1$ , MUST BE FAST RECOVERY TYPES e.g.,

1N5825 USED ABOVE  $I_B \approx 100$  mA

MSD6100 USED BELOW  $I_B \approx 100$  mA

FOR  $t_d$  AND  $t_r$ ,  $D_1$  IS DISCONNECTED AND  $V_2 = 0$

$t_r, t_f \leq 10$  ns

DUTY CYCLE = 1.0%

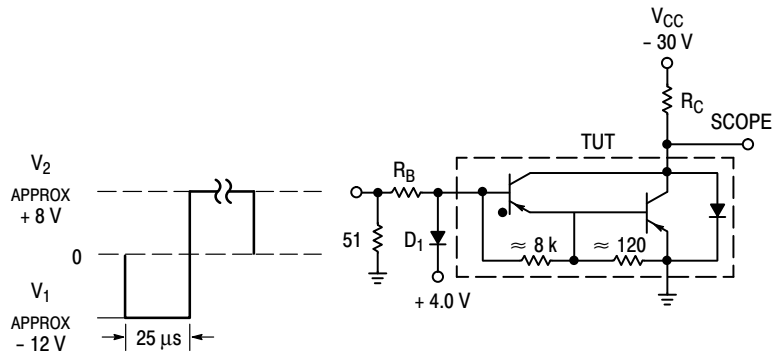

Figure 2. Switching Times Test Circuit

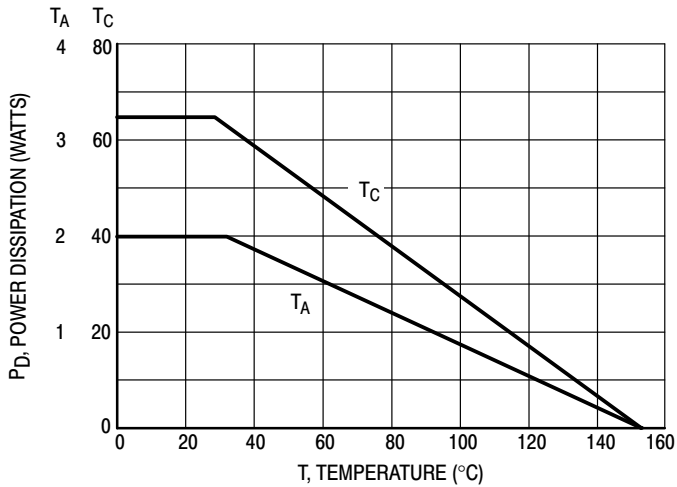

Figure 3. Power Derating

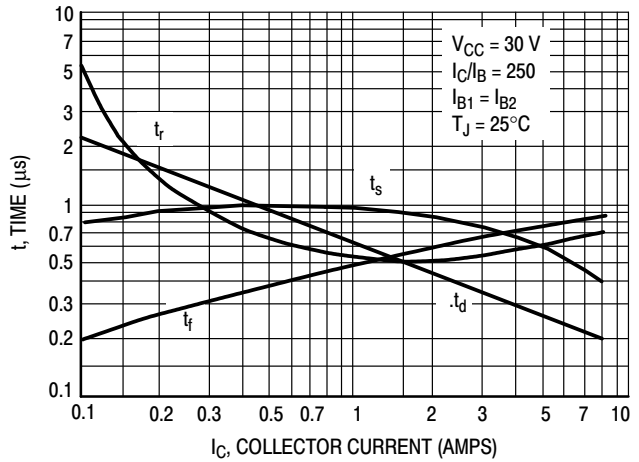

Figure 4. Typical Switching Times

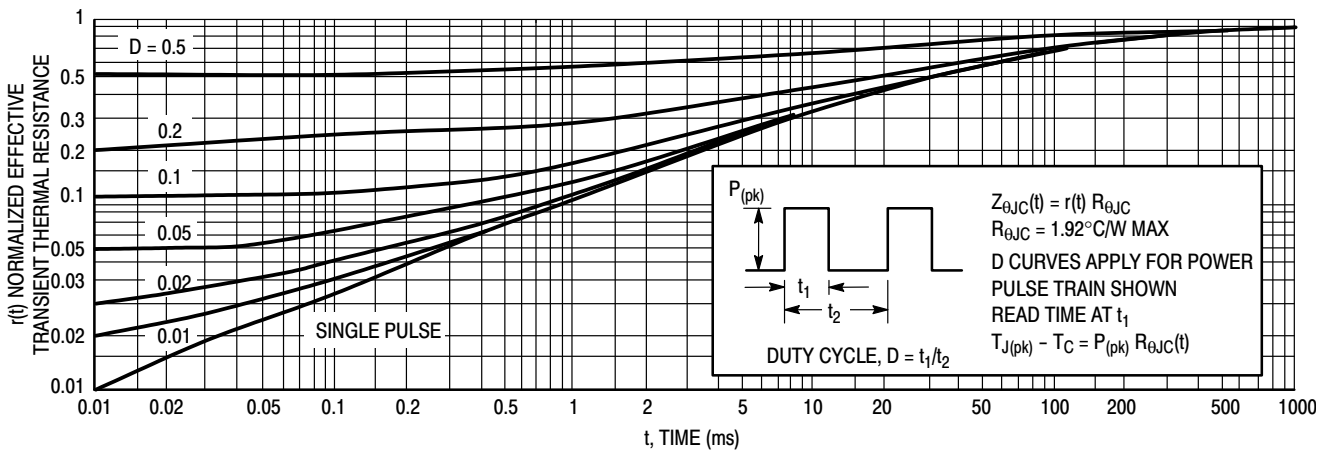
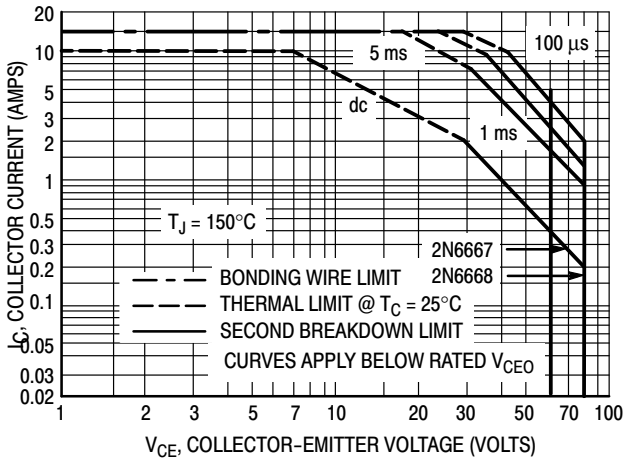

Figure 5. Thermal Response

## 2N6667, 2N6668



**Figure 6. Maximum Safe Operating Area**

There are two limitations on the power handling ability of a transistor: average junction temperature and second breakdown. Safe operating area curves indicate  $I_C - V_{CE}$  limits of the transistor that must be observed for reliable operation; i.e., the transistor must not be subjected to greater dissipation than the curves indicate.

The data of Figure 6 is based on  $T_{J(pk)} = 150^\circ\text{C}$ ;  $T_C$  is variable depending on conditions. Second breakdown pulse limits are valid for duty cycles to 10% provided  $T_{J(pk)} < 150^\circ\text{C}$ .  $T_{J(pk)}$  may be calculated from the data in Figure 5. At high case temperatures, thermal limitations will reduce the power that can be handled to values less than the limitations imposed by second breakdown.

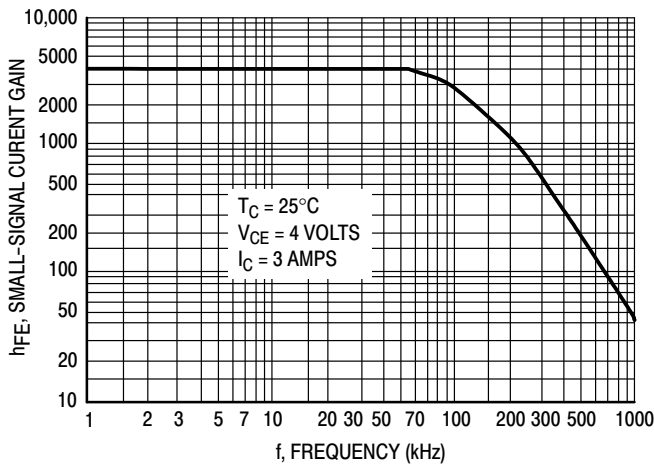

**Figure 7. Typical Small-Signal Current Gain**

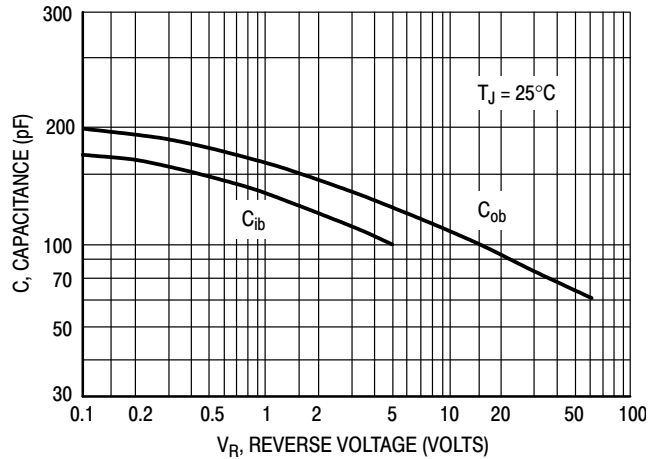

**Figure 8. Typical Capacitance**

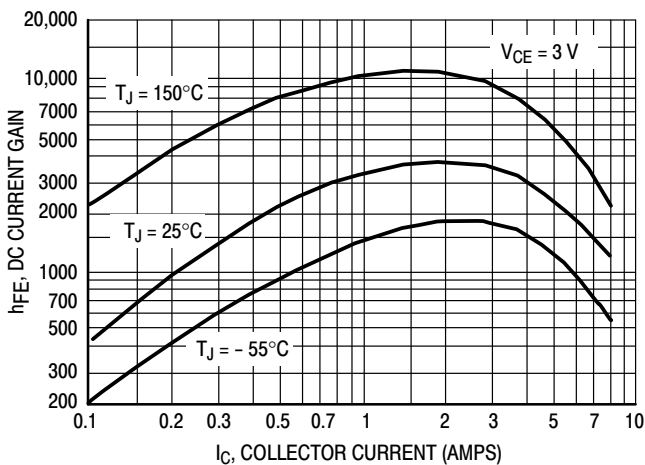

**Figure 9. Typical DC Current Gain**

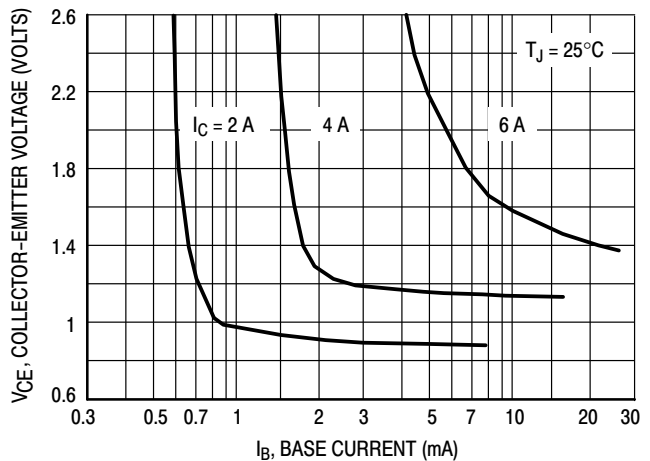

**Figure 10. Typical Collector Saturation Region**

# 2N6667, 2N6668

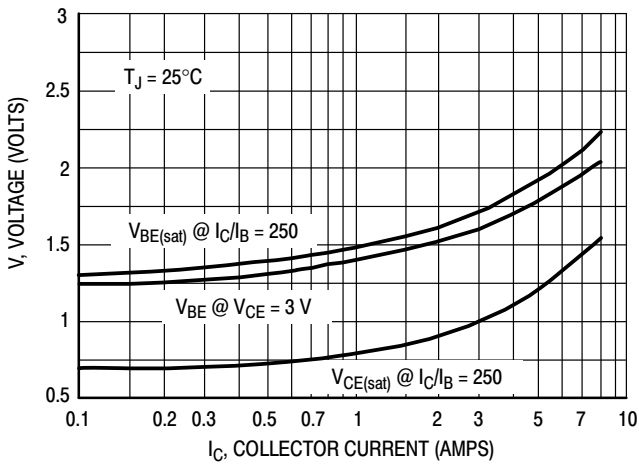

Figure 11. Typical "On" Voltages

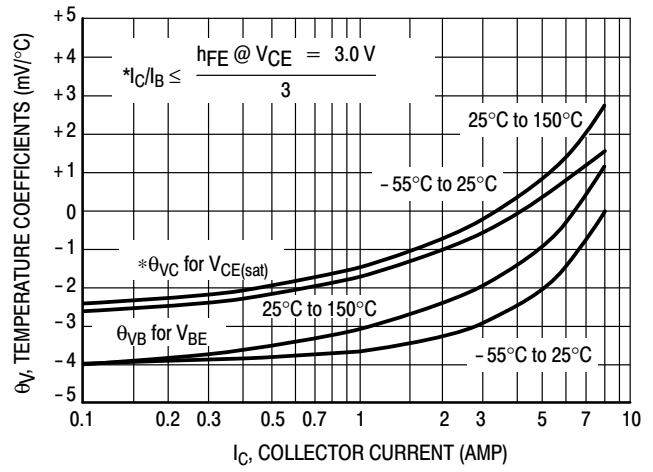

Figure 12. Typical Temperature Coefficients

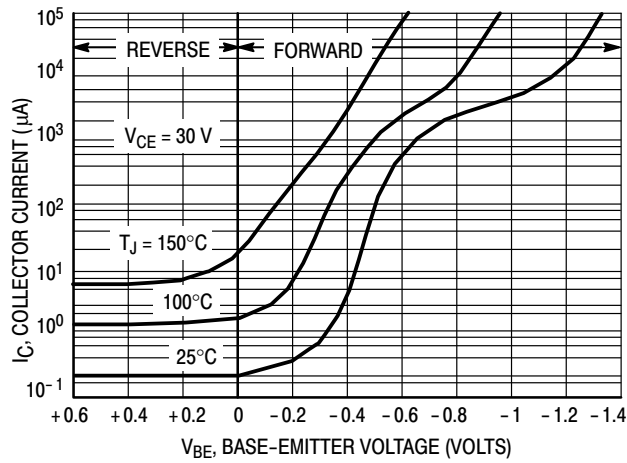
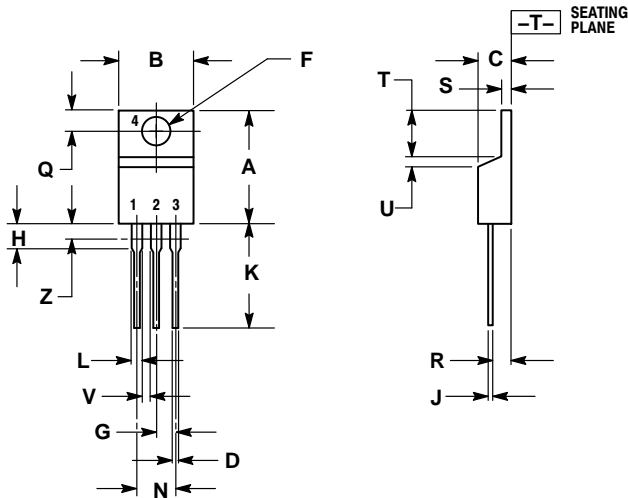

Figure 13. Typical Collector Cut-Off Region

# 2N6667, 2N6668

## PACKAGE DIMENSIONS

TO-220  
CASE 221A-09  
ISSUE AH



NOTES:

1. DIMENSIONING AND TOLERANCING PER ANSI Y14.5M, 1982.
2. CONTROLLING DIMENSION: INCH.
3. DIMENSION Z DEFINES A ZONE WHERE ALL BODY AND LEAD IRREGULARITIES ARE ALLOWED.

DIM	INCHES		MILLIMETERS	
	MIN	MAX	MIN	MAX
A	0.570	0.620	14.48	15.75
B	0.380	0.415	9.66	10.53
C	0.160	0.190	4.07	4.83
D	0.025	0.038	0.64	0.96
F	0.142	0.161	3.61	4.09
G	0.095	0.105	2.42	2.66
H	0.110	0.161	2.80	4.10
J	0.014	0.024	0.36	0.61
K	0.500	0.562	12.70	14.27
L	0.045	0.060	1.15	1.52
N	0.190	0.210	4.83	5.33
Q	0.100	0.120	2.54	3.04
R	0.080	0.110	2.04	2.79
S	0.045	0.055	1.15	1.39
T	0.235	0.255	5.97	6.47
U	0.000	0.050	0.00	1.27
V	0.045	---	1.15	---
Z	---	0.080	---	2.04

STYLE 1:

1. BASE
2. COLLECTOR
3. EMITTER
4. COLLECTOR

ON Semiconductor and the are registered trademarks of Semiconductor Components Industries, LLC (SCILLC) or its subsidiaries in the United States and/or other countries. SCILLC owns the rights to a number of patents, trademarks, copyrights, trade secrets, and other intellectual property. A listing of SCILLC's product/patent coverage may be accessed at [www.onsemi.com/site/pdf/Patent-Marking.pdf](http://www.onsemi.com/site/pdf/Patent-Marking.pdf). SCILLC reserves the right to make changes without further notice to any products herein. SCILLC makes no warranty, representation or guarantee regarding the suitability of its products for any particular purpose, nor does SCILLC assume any liability arising out of the application or use of any product or circuit, and specifically disclaims any and all liability, including without limitation special, consequential or incidental damages. "Typical" parameters which may be provided in SCILLC data sheets and/or specifications can and do vary in different applications and actual performance may vary over time. All operating parameters, including "Typicals" must be validated for each customer application by customer's technical experts. SCILLC does not convey any license under its patent rights nor the rights of others. SCILLC products are not designed, intended, or authorized for use as components in systems intended for surgical implant into the body, or other applications intended to support or sustain life, or for any other application in which the failure of the SCILLC product could create a situation where personal injury or death may occur. Should Buyer purchase or use SCILLC products for any such unintended or unauthorized application, Buyer shall indemnify and hold SCILLC and its officers, employees, subsidiaries, affiliates, and distributors harmless against all claims, costs, damages, and expenses, and reasonable attorney fees arising out of, directly or indirectly, any claim of personal injury or death associated with such unintended or unauthorized use, even if such claim alleges that SCILLC was negligent regarding the design or manufacture of the part. SCILLC is an Equal Opportunity/Affirmative Action Employer. This literature is subject to all applicable copyright laws and is not for resale in any manner.

### PUBLICATION ORDERING INFORMATION

**LITERATURE FULFILLMENT:**

Literature Distribution Center for ON Semiconductor  
P.O. Box 5163, Denver, Colorado 80217 USA  
Phone: 303-675-2175 or 800-344-3860 Toll Free USA/Canada  
Fax: 303-675-2176 or 800-344-3867 Toll Free USA/Canada  
Email: [orderlit@onsemi.com](mailto:orderlit@onsemi.com)

**N. American Technical Support:** 800-282-9855 Toll Free  
USA/Canada  
**Europe, Middle East and Africa Technical Support:**  
Phone: 421 33 790 2910  
**Japan Customer Focus Center**  
Phone: 81-3-5817-1050



**ON Semiconductor Website:** [www.onsemi.com](http://www.onsemi.com)

**Order Literature:** <http://www.onsemi.com/orderlit>

For additional information, please contact your local Sales Representative

## Looking for pricing, stock, or lifecycle information?

Click below to explore more details on WIN SOURCE:

-  [View 2N6667G on WIN SOURCE](#)
-  [ON Semiconductor](#) Information

## Optimize Your Supply Chain with WIN SOURCE Solutions

-  Global Sourcing Solution
-  Obsolete Management
-  Cost Control Management
-  Shortage Management
-  Alternative Solution
-  Excess Inventory Management