





# 74CBTLV3257

Quad 1-of-2 multiplexer/demultiplexer

Rev. 10 — 13 November 2025

Product data sheet

## 1. General description

---

The 74CBTLV3257 provides a quad 1-of-2 high-speed multiplexer/demultiplexer with common select (S) and output enable ( $\overline{OE}$ ) inputs. The low ON resistance of the switch allows inputs to be connected to outputs without adding propagation delay or generating additional ground bounce noise. When pin  $\overline{OE}$  = LOW, one of the two switches is selected (low-impedance ON-state) with pin S. When pin  $\overline{OE}$  = HIGH, all switches are in the high-impedance OFF-state, independent of pin S.

Schmitt trigger action at control input makes the circuit tolerant to slower input rise and fall times across the entire  $V_{CC}$  range from 2.3 V to 3.6 V.

To ensure the high-impedance OFF-state during power-up or power-down,  $\overline{OE}$  should be tied to the  $V_{CC}$  through a pull-up resistor. The minimum value of the resistor is determined by the current-sinking capability of the driver.

This device is fully specified for partial power-down applications using  $I_{OFF}$ . The  $I_{OFF}$  circuitry disables the output, preventing the damaging backflow current through the device when it is powered down.

## 2. Features and benefits

---

- Supply voltage range from 2.3 V to 3.6 V
- High noise immunity
- Complies with JEDEC standard:
  - JESD8-5 (2.3 V to 2.7 V)
  - JESD8-B/JESD36 (2.7 V to 3.6 V)
- 5  $\Omega$  switch connection between two ports
- Rail to rail switching on data I/O ports
- CMOS low power consumption
- Latch-up performance exceeds 250 mA per JESD78B Class I level A
- $I_{OFF}$  circuitry provides partial Power-down mode operation
- ESD protection:
  - HBM: ANSI/ESDA/JEDEC JS-001 class 2 exceeds 2000 V
  - CDM: ANSI/ESDA/JEDEC JS-002 class C3 exceeds 1000 V
- Multiple package options
- Specified from -40 °C to +85 °C and -40 °C to +125 °C

### 3. Ordering information

Table 1. Ordering information

Type number	Package			
	Temperature range	Name	Description	Version
<a href="#">74CBTLV3257D</a>	-40 °C to +125 °C	SO16	plastic small outline package; 16 leads; body width 3.9 mm	<a href="#">SOT109-1</a>
<a href="#">74CBTLV3257DS</a>	-40 °C to +125 °C	SSOP16 [1]	plastic shrink small outline package; 16 leads; body width 3.9 mm; lead pitch 0.635 mm	<a href="#">SOT519-1</a>
<a href="#">74CBTLV3257PW</a>	-40 °C to +125 °C	TSSOP16	plastic thin shrink small outline package; 16 leads; body width 4.4 mm	<a href="#">SOT403-1</a>
<a href="#">74CBTLV3257BQ</a>	-40 °C to +125 °C	DHVQFN16	plastic dual in-line compatible thermal enhanced very thin quad flat package; no leads; 16 terminals; body 2.5 × 3.5 × 0.85 mm	<a href="#">SOT763-1</a>
<a href="#">74CBTLV3257GU</a>	-40 °C to +125 °C	XQFN16	plastic, extremely thin quad flat package; no leads; 16 terminals; body 1.80 × 2.60 × 0.50 mm	<a href="#">SOT1161-1</a>

[1] Also known as QSOP16.

### 4. Marking

Table 2. Marking codes

Type number	Marking code[1]
74CBTLV3257D	74CBTLV3257D
74CBTLV3257DS	TLV3257
74CBTLV3257PW	TLV3257
74CBTLV3257BQ	TV3257
74CBTLV3257GU	b57

[1] The pin 1 indicator is located on the lower left corner of the device, below the marking code.

5. Functional diagram



Fig. 1. Logic diagram

## 6. Pinning information

### 6.1. Pinning



## 6.2. Pin description

Table 3. Pin description

Symbol	Pin		Description
	SO16, (T)SSOP16 and DHVQFN16	XQFN16	
S	1	15	select input
1B1 to 4B1	2, 5, 11, 14	16, 3, 9, 12	B1 input/output
1B2 to 4B2	3, 6, 10, 13	1, 4, 8, 11	B2 input/output
1A to 4A	4, 7, 9, 12	2, 5, 7, 10	A input/output
GND	8	6	ground (0 V)
$\overline{\text{OE}}$	15	13	output enable input (active LOW)
V <sub>CC</sub>	16	14	supply voltage

## 7. Functional description

Table 4. Function table

H = HIGH voltage level; L = LOW voltage level; X = don't care.

Inputs		Function switch
$\overline{\text{OE}}$	S	
L	L	nA = nB1
L	H	nA = nB2
H	X	disconnect nA and nBn

## 8. Limiting values

**Table 5. Limiting values**

In accordance with the Absolute Maximum Rating System (IEC 60134). Voltages are referenced to GND (ground = 0 V).

Symbol	Parameter	Conditions	Min	Max	Unit
$V_{CC}$	supply voltage		-0.5	+4.6	V
$V_I$	input voltage	control inputs [1]	-0.5	+4.6	V
$V_{SW}$	switch voltage	enable and disable mode [2]	-0.5	$V_{CC} + 0.5$	V
$I_{IK}$	input clamping current	$V_I < -0.5$ V	-50	-	mA
$I_{SK}$	switch clamping current	$V_I < -0.5$ V	-50	-	mA
$I_{SW}$	switch current	$V_{SW} = 0$ V to $V_{CC}$	-	$\pm 128$	mA
$I_{CC}$	supply current		-	+100	mA
$I_{GND}$	ground current		-100	-	mA
$T_{stg}$	storage temperature		-65	+150	°C
$P_{tot}$	total power dissipation	$T_{amb} = -40$ °C to +125 °C			
		SOT109-1 (SO16) SOT519-1 (SSOP16) SOT403-1 (TSSOP16) SOT763-1 (DHVQFN16) [3]	-	500	mW
		SOT1161-1 (XQFN16)	-	250	mW

[1] The minimum input voltage rating may be exceeded if the input clamping current ratings are observed.

[2] The switch voltage ratings may be exceeded if switch clamping current ratings are observed

[3] For SOT109-1 (SO16) package:  $P_{tot}$  derates linearly with 12.4 mW/K above 110 °C.

For SOT519-1 (SSOP16) packages:  $P_{tot}$  derates linearly with 8.5 mW/K above 91 °C.

For SOT403-1 (TSSOP16) package:  $P_{tot}$  derates linearly with 8.5 mW/K above 91 °C.

For SOT763-1 (DHVQFN16) package:  $P_{tot}$  derates linearly with 11.2 mW/K above 106 °C.

## 9. Recommended operating conditions

**Table 6. Recommended operating conditions**

Symbol	Parameter	Conditions	Min	Max	Unit
$V_{CC}$	supply voltage		2.3	3.6	V
$V_I$	input voltage		0	3.6	V
$V_{SW}$	switch voltage	enable and disable mode	0	$V_{CC}$	V
$T_{amb}$	ambient temperature		-40	+125	°C
$\Delta t/\Delta V$	input transition rise and fall rate	$V_{CC} = 2.3$ V to 3.6 V [1]	0	200	ns/V

[1] Applies to control signal levels.

## 10. Static characteristics

**Table 7. Static characteristics**

At recommended operating conditions voltages are referenced to GND (ground = 0 V).

Symbol	Parameter	Conditions	T <sub>amb</sub> = -40 °C to +85 °C			T <sub>amb</sub> = -40 °C to +125 °C		Unit
			Min	Typ[1]	Max	Min	Max	
V <sub>IH</sub>	HIGH-level input voltage	V <sub>CC</sub> = 2.3 V to 2.7 V	1.7	-	-	1.7	-	V
		V <sub>CC</sub> = 2.7 V to 3.6 V	2.0	-	-	2.0	-	V
V <sub>IL</sub>	LOW-level input voltage	V <sub>CC</sub> = 2.3 V to 2.7 V	-	-	0.7	-	0.7	V
		V <sub>CC</sub> = 2.7 V to 3.0 V	-	-	0.8	-	0.8	V
		V <sub>CC</sub> = 3.0 V to 3.6 V	-	-	0.9	-	0.9	V
I <sub>I</sub>	input leakage current	pin $\overline{\text{OE}}$ , S; V <sub>CC</sub> = 3.6 V; V <sub>I</sub> = GND to V <sub>CC</sub>	-	-	±1	-	±20	µA
I <sub>S(OFF)</sub>	OFF-state leakage current	V <sub>CC</sub> = 3.6 V; see Fig. 2	-	-	±1	-	±20	µA
I <sub>S(ON)</sub>	ON-state leakage current	V <sub>CC</sub> = 3.6 V; see Fig. 3	-	-	±1	-	±20	µA
I <sub>OFF</sub>	power-off leakage current	V <sub>I</sub> or V <sub>O</sub> = 0 V to 3.6 V; V <sub>CC</sub> = 0 V	-	-	±10	-	±50	µA
I <sub>CC</sub>	supply current	V <sub>I</sub> = GND or V <sub>CC</sub> ; V <sub>SW</sub> = GND or V <sub>CC</sub> ; V <sub>CC</sub> = 3.6 V; I <sub>O</sub> = 0 A	-	-	10	-	50	µA
ΔI <sub>CC</sub>	additional supply current	pin $\overline{\text{OE}}$ , S; V <sub>CC</sub> = 3.6 V; V <sub>I</sub> = V <sub>CC</sub> - 0.6 V; V <sub>SW</sub> = GND or V <sub>CC</sub> [2]	-	-	300	-	2000	µA
C <sub>I</sub>	input capacitance	pin $\overline{\text{OE}}$ , S; V <sub>CC</sub> = 3.3 V; V <sub>I</sub> = 0 V to 3.3 V	-	0.9	-	-	-	pF
C <sub>S(OFF)</sub>	OFF-state capacitance	V <sub>CC</sub> = 3.3 V; V <sub>I</sub> = 0 V to 3.3 V	-	5.2	-	-	-	pF
C <sub>S(ON)</sub>	ON-state capacitance	V <sub>CC</sub> = 3.3 V; V <sub>I</sub> = 0 V to 3.3 V	-	14.3	-	-	-	pF

[1] All typical values are measured at T<sub>amb</sub> = 25 °C.

[2] One input at 3 V, other inputs at V<sub>CC</sub> or GND.

### 10.1. Test circuits



### 10.2. ON resistance

**Table 8. Resistance  $R_{ON}$**

At recommended operating conditions; voltages are referenced to GND (ground = 0 V); for test circuit see Fig. 4.

Symbol	Parameter	Conditions	$T_{amb} = -40\text{ }^{\circ}\text{C to }+85\text{ }^{\circ}\text{C}$			$T_{amb} = -40\text{ }^{\circ}\text{C to }+125\text{ }^{\circ}\text{C}$		Unit
			Min	Typ[1]	Max	Min	Max	
$R_{ON}$	ON resistance	$V_{CC} = 2.3\text{ V to }2.7\text{ V};$ see Fig. 5 to Fig. 7 [2]						
		$I_{SW} = 64\text{ mA}; V_I = 0\text{ V}$	-	4.2	8.0	-	15.0	$\Omega$
		$I_{SW} = 24\text{ mA}; V_I = 0\text{ V}$	-	4.2	8.0	-	15.0	$\Omega$
		$I_{SW} = 15\text{ mA}; V_I = 1.7\text{ V}$	-	8.4	40.0	-	60.0	$\Omega$
		$V_{CC} = 3.0\text{ V to }3.6\text{ V};$ see Fig. 8 to Fig. 10						
		$I_{SW} = 64\text{ mA}; V_I = 0\text{ V}$	-	4.0	7.0	-	11.0	$\Omega$
		$I_{SW} = 24\text{ mA}; V_I = 0\text{ V}$	-	4.0	7.0	-	11.0	$\Omega$
$I_{SW} = 15\text{ mA}; V_I = 2.4\text{ V}$	-	6.2	15.0	-	25.5	$\Omega$		

- [1] Typical values are measured at  $T_{amb} = 25\text{ }^{\circ}\text{C}$  and nominal  $V_{CC}$ .
- [2] Measured by the voltage drop between the A and B terminals at the indicated current through the switch. ON-state resistance is determined by the lower of the voltages of the two (A or B) terminals.

### 10.3. ON resistance test circuit and graphs

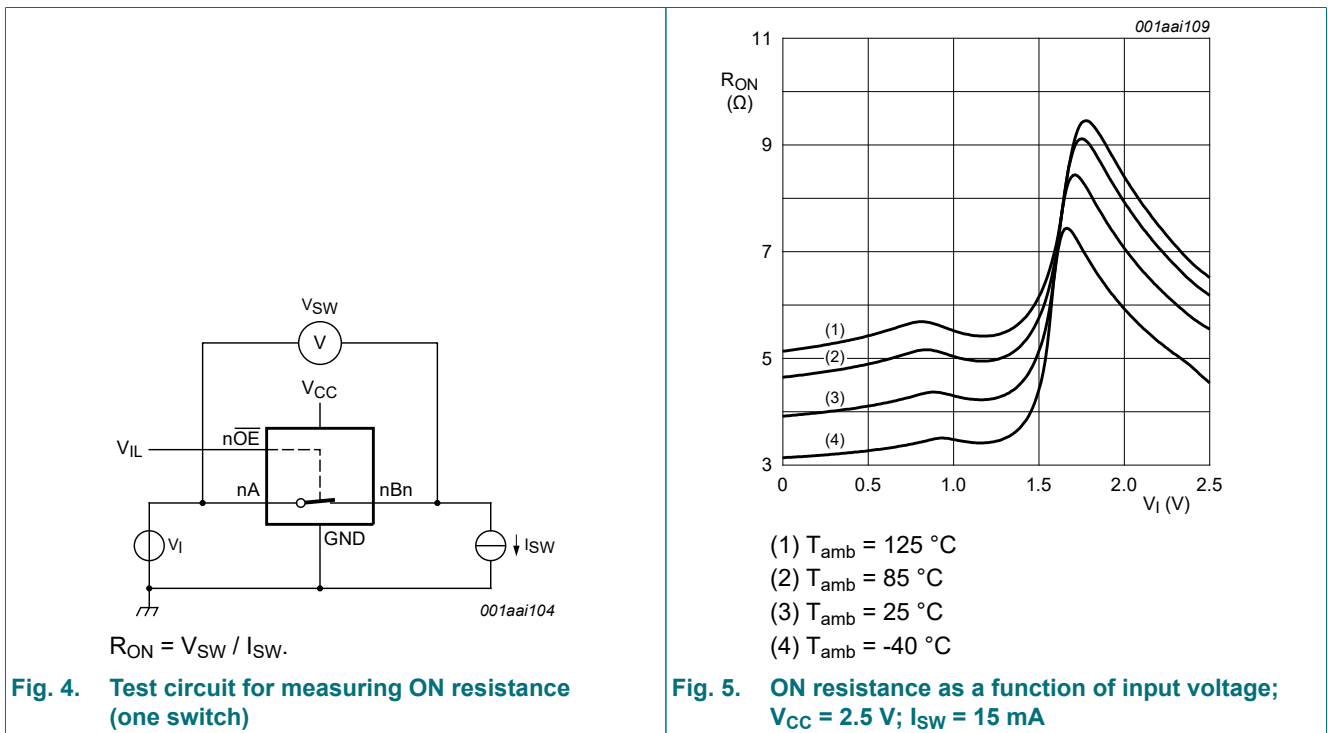

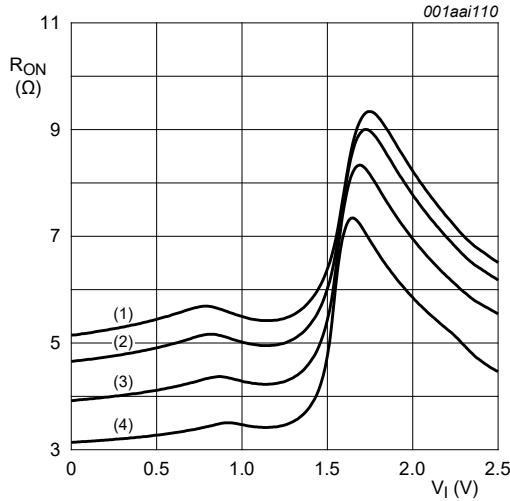

- (1)  $T_{amb} = 125\text{ }^{\circ}\text{C}$
- (2)  $T_{amb} = 85\text{ }^{\circ}\text{C}$
- (3)  $T_{amb} = 25\text{ }^{\circ}\text{C}$
- (4)  $T_{amb} = -40\text{ }^{\circ}\text{C}$

**Fig. 6.** ON resistance as a function of input voltage;  $V_{CC} = 2.5\text{ V}$ ;  $I_{SW} = 24\text{ mA}$

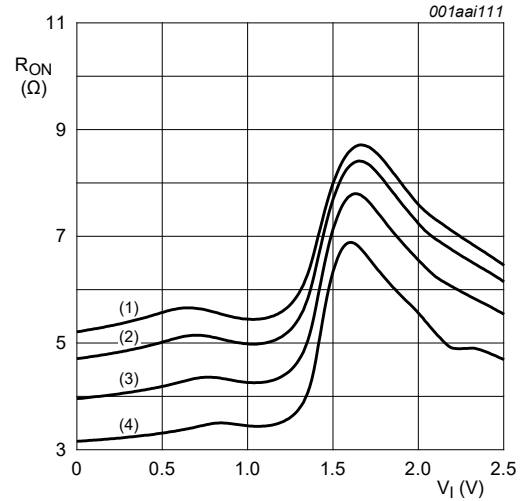

- (1)  $T_{amb} = 125\text{ }^{\circ}\text{C}$
- (2)  $T_{amb} = 85\text{ }^{\circ}\text{C}$
- (3)  $T_{amb} = 25\text{ }^{\circ}\text{C}$
- (4)  $T_{amb} = -40\text{ }^{\circ}\text{C}$

**Fig. 7.** ON resistance as a function of input voltage;  $V_{CC} = 2.5\text{ V}$ ;  $I_{SW} = 64\text{ mA}$

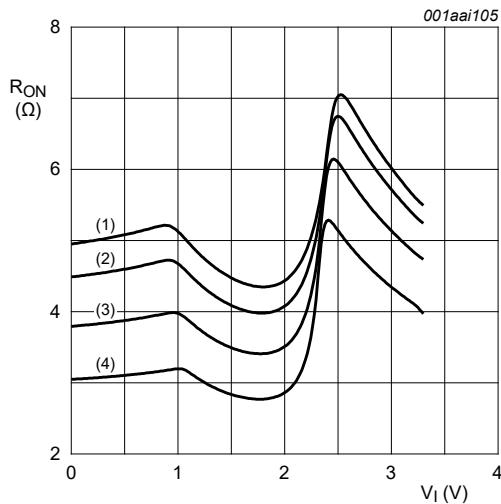

- (1)  $T_{amb} = 125\text{ }^{\circ}\text{C}$
- (2)  $T_{amb} = 85\text{ }^{\circ}\text{C}$
- (3)  $T_{amb} = 25\text{ }^{\circ}\text{C}$
- (4)  $T_{amb} = -40\text{ }^{\circ}\text{C}$

**Fig. 8.** ON resistance as a function of input voltage;  $V_{CC} = 3.3\text{ V}$ ;  $I_{SW} = 15\text{ mA}$

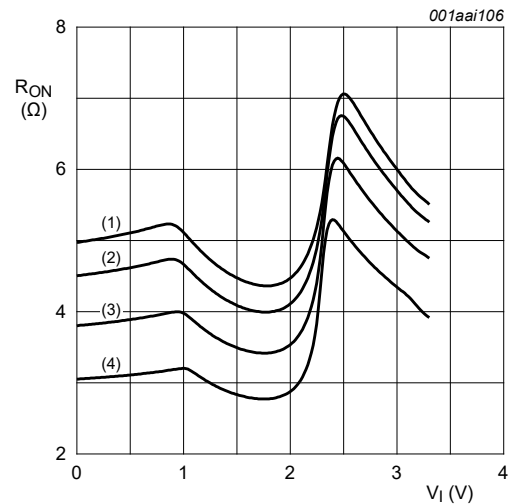

- (1)  $T_{amb} = 125\text{ }^{\circ}\text{C}$
- (2)  $T_{amb} = 85\text{ }^{\circ}\text{C}$
- (3)  $T_{amb} = 25\text{ }^{\circ}\text{C}$
- (4)  $T_{amb} = -40\text{ }^{\circ}\text{C}$

**Fig. 9.** ON resistance as a function of input voltage;  $V_{CC} = 3.3\text{ V}$ ;  $I_{SW} = 24\text{ mA}$



- (1)  $T_{amb} = 125\text{ °C}$
- (2)  $T_{amb} = 85\text{ °C}$
- (3)  $T_{amb} = 25\text{ °C}$
- (4)  $T_{amb} = -40\text{ °C}$

Fig. 10. ON resistance as a function of input voltage;  $V_{CC} = 3.3\text{ V}$ ;  $I_{SW} = 64\text{ mA}$

## 11. Dynamic characteristics

Table 9. Dynamic characteristics

$GND = 0\text{ V}$ ; for test circuit see Fig. 13.

Symbol	Parameter	Conditions	$T_{amb} = -40\text{ °C to }+85\text{ °C}$			$T_{amb} = -40\text{ °C to }+125\text{ °C}$		Unit
			Min	Typ[1]	Max	Min	Max	
$t_{pd}$	propagation delay	nA to nBn or nBn to nA; see Fig. 11 [2] [3]						
		$V_{CC} = 2.3\text{ V to }2.7\text{ V}$	-	-	0.15	-	0.25	ns
		$V_{CC} = 3.0\text{ V to }3.6\text{ V}$	-	-	0.15	-	0.25	ns
		S to nA; see Fig. 11 [3]						
		$V_{CC} = 2.3\text{ V to }2.7\text{ V}$	1.0	3.8	6.1	1.0	6.7	ns
		$V_{CC} = 3.0\text{ V to }3.6\text{ V}$	1.0	3.2	5.3	1.0	5.8	ns
$t_{en}$	enable time	$\overline{OE}$ to nA or nBn; see Fig. 12 [4]						
		$V_{CC} = 2.3\text{ V to }2.7\text{ V}$	1.0	2.2	5.6	1.0	6.2	ns
		$V_{CC} = 3.0\text{ V to }3.6\text{ V}$	1.0	2.0	5.0	1.0	5.5	ns
		S to nBn; see Fig. 12 [4]						
		$V_{CC} = 2.3\text{ V to }2.7\text{ V}$	1.0	3.5	6.1	1.0	6.7	ns
		$V_{CC} = 3.0\text{ V to }3.6\text{ V}$	1.0	3.0	5.3	1.0	5.8	ns

Symbol	Parameter	Conditions	T <sub>amb</sub> = -40 °C to +85 °C			T <sub>amb</sub> = -40 °C to +125 °C		Unit
			Min	Typ[1]	Max	Min	Max	
t <sub>dis</sub>	disable time	OĒ to nA or nBn; see Fig. 12 [5]						
		V <sub>CC</sub> = 2.3 V to 2.7 V	1.0	2.6	5.5	1.0	6.1	ns
		V <sub>CC</sub> = 3.0 V to 3.6 V	1.0	3.1	5.5	1.0	6.1	ns
		S to nBn; see Fig. 12 [5]						
		V <sub>CC</sub> = 2.3 V to 2.7 V	1.0	2.6	4.8	1.0	5.3	ns
		V <sub>CC</sub> = 3.0 V to 3.6 V	1.0	3.2	4.5	1.0	5.0	ns

- [1] All typical values are measured at T<sub>amb</sub> = 25 °C and at nominal V<sub>CC</sub>.
- [2] The propagation delay is the calculated RC time constant of the typical on-state resistance of the switch and the load capacitance, when driven by an ideal voltage source (zero output impedance).
- [3] t<sub>pd</sub> is the same as t<sub>PLH</sub> and t<sub>PHL</sub>.
- [4] t<sub>en</sub> is the same as t<sub>PZH</sub> and t<sub>PZL</sub>.
- [5] t<sub>dis</sub> is the same as t<sub>PHZ</sub> and t<sub>PLZ</sub>.

### 11.1. Waveforms and test circuit



Table 10. Measurement points

Supply voltage	Input			Output		
V <sub>CC</sub>	V <sub>M</sub>	V <sub>I</sub>	t <sub>r</sub> = t <sub>f</sub>	V <sub>M</sub>	V <sub>X</sub>	V <sub>Y</sub>
2.3 V to 2.7 V	0.5 × V <sub>CC</sub>	V <sub>CC</sub>	≤ 2.0 ns	0.5 × V <sub>CC</sub>	V <sub>OL</sub> + 0.15 V	V <sub>OH</sub> - 0.15 V
3.0 V to 3.6 V	0.5 × V <sub>CC</sub>	V <sub>CC</sub>	≤ 2.0 ns	0.5 × V <sub>CC</sub>	V <sub>OL</sub> + 0.3 V	V <sub>OH</sub> - 0.3 V



001aae331

Test data is given in [Table 11](#).

Definitions for test circuit:

R<sub>L</sub> = Load resistance;

C<sub>L</sub> = Load capacitance including jig and probe capacitance;

R<sub>T</sub> = Termination resistance should be equal to the output impedance Z<sub>O</sub> of the pulse generator;

V<sub>EXT</sub> = External voltage for measuring switching times.

Fig. 13. Test circuit for measuring switching times

Table 11. Test data

Supply voltage	Load		V <sub>EXT</sub>		
V <sub>CC</sub>	C <sub>L</sub>	R <sub>L</sub>	t <sub>PLH</sub> , t <sub>PHL</sub>	t <sub>PZH</sub> , t <sub>PHZ</sub>	t <sub>PZL</sub> , t <sub>PLZ</sub>
2.3 V to 2.7 V	30 pF	500 Ω	open	GND	2 × V <sub>CC</sub>
3.0 V to 3.6 V	50 pF	500 Ω	open	GND	2 × V <sub>CC</sub>

11.2. Additional dynamic characteristics

Table 12. Additional dynamic characteristics

At recommended operating conditions; voltages are referenced to GND (ground = 0 V);  $V_I = GND$  or  $V_{CC}$  (unless otherwise specified);  $t_r = t_f \leq 2.5$  ns.

Symbol	Parameter	Conditions	$T_{amb} = 25\text{ }^\circ\text{C}$			Unit
			Min	Typ	Max	
$f_{(-3dB)}$	-3 dB frequency response	$V_{CC} = 3.3$ V; $R_L = 50\ \Omega$ ; see Fig. 14 [1]	-	398	-	MHz

[1]  $f_i$  is biased at  $0.5 \times V_{CC}$ .

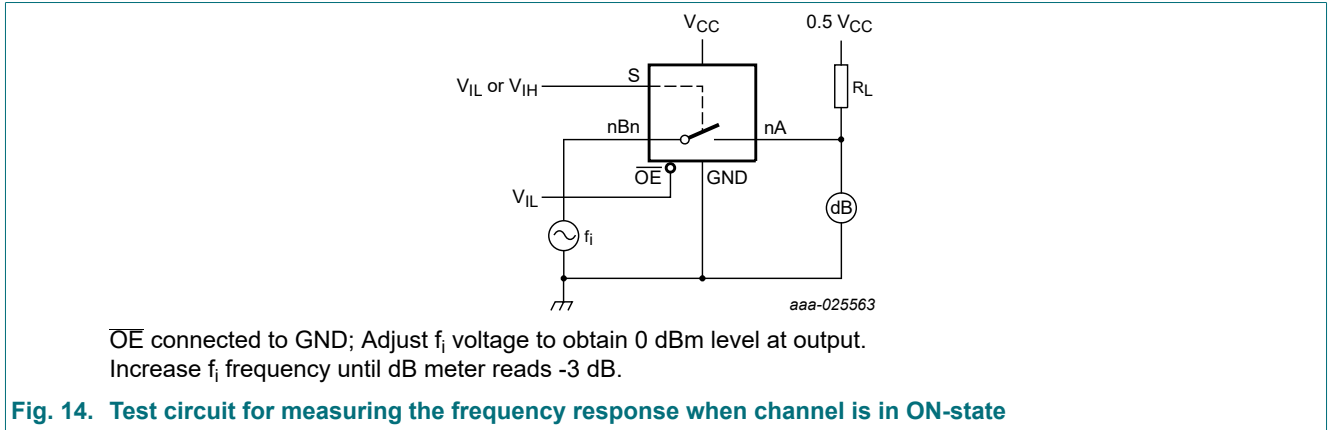

12. Package outline

SO16: plastic small outline package; 16 leads; body width 3.9 mm

SOT109-1



Fig. 15. Package outline SOT109-1 (SO16)

SSOP16: plastic shrink small outline package; 16 leads; body width 3.9 mm; lead pitch 0.635 mm SOT519-1



Fig. 16. Package outline SOT519-1 (SSOP16)

TSSOP16: plastic thin shrink small outline package; 16 leads; body width 4.4 mm

SOT403-1



Fig. 17. Package outline SOT403-1 (TSSOP16)

DHVQFN16: plastic dual in-line compatible thermal enhanced very thin quad flat package; no leads; 16 terminals; body 2.5 x 3.5 x 0.85 mm

SOT763-1



Fig. 18. Package outline SOT763-1 (DHVQFN16)

**XQFN16:** plastic, extremely thin quad flat package; no leads; 16 terminals; body 1.80 x 2.60 x 0.50 mm

SOT1161-1



Fig. 19. Package outline SOT1161-1 (XQFN16)

## 13. Abbreviations

Table 13. Abbreviations

Acronym	Description
CDM	Charged Device Model
CMOS	Complementary Metal-Oxide Semiconductor
DUT	Device Under Test
ESD	ElectroStatic Discharge
HBM	Human Body Model

## 14. Revision history

Table 14. Revision history

Document ID	Release date	Data sheet status	Change notice	Supersedes
74CBTLV3257 v.10	20251113	Product data sheet	-	74CBTLV3257 v.9
Modifications:	<ul style="list-style-type: none"> <li><a href="#">Table 7</a>: Conditions for <math>V_{IH}</math> and <math>V_{IL}</math> have been extended.</li> </ul>			
74CBTLV3257 v.9	20240201	Product data sheet	-	74CBTLV3257 v.8
Modifications:	<ul style="list-style-type: none"> <li><a href="#">Section 2</a>: ESD specification updated according to the latest JEDEC standard.</li> <li><a href="#">Fig. 15</a>, <a href="#">Fig. 17</a>: Aligned SO and TSSOP package outline drawings to JEDEC MS-012 and MO-153</li> </ul>			
74CBTLV3257 v.8	20230321	Product data sheet	-	74CBTLV3257 v.7
Modifications:	<ul style="list-style-type: none"> <li><a href="#">Table 5</a>: Derating values for <math>P_{tot}</math> total power dissipation updated.</li> </ul>			
74CBTLV3257 v.7	20190409	Product data sheet	-	74CBTLV3257 v.6
Modifications:	<ul style="list-style-type: none"> <li>The format of this data sheet has been redesigned to comply with the identity guidelines of Nexperia.</li> <li>Legal texts have been adapted to the new company name where appropriate.</li> <li>Link corrected in <a href="#">Section 11</a>.</li> </ul>			
74CBTLV3257 v.6	20171211	Product data sheet	-	74CBTLV3257 v.5
Modifications:	<ul style="list-style-type: none"> <li>Type number 74CBTLV3257GU (SOT1161-1 / XQFN16) added.</li> </ul>			
74CBTLV3257 v.5	20161111	Product data sheet	-	74CBTLV3257 v.4
Modifications:	<ul style="list-style-type: none"> <li><a href="#">Section 11.2</a> added.</li> </ul>			
74CBTLV3257 v.4	20111216	Product data sheet	-	74CBTLV3257 v.3
Modifications:	<ul style="list-style-type: none"> <li>Legal pages updated.</li> </ul>			
74CBTLV3257 v.3	20110106	Product data sheet	-	74CBTLV3257 v.2
74CBTLV3257 v.2	20101126	Product data sheet	-	74CBTLV3257 v.1
74CBTLV3257 v.1	20100112	Product data sheet	-	-

## 15. Legal information

### Data sheet status

Document status [1][2]	Product status [3]	Definition
Objective [short] data sheet	Development	This document contains data from the objective specification for product development.
Preliminary [short] data sheet	Qualification	This document contains data from the preliminary specification.
Product [short] data sheet	Production	This document contains the product specification.

- [1] Please consult the most recently issued document before initiating or completing a design.
- [2] The term 'short data sheet' is explained in section "Definitions".
- [3] The product status of device(s) described in this document may have changed since this document was published and may differ in case of multiple devices. The latest product status information is available on the internet at <https://www.nexperia.com>.

### Definitions

**Draft** — The document is a draft version only. The content is still under internal review and subject to formal approval, which may result in modifications or additions. Nexperia does not give any representations or warranties as to the accuracy or completeness of information included herein and shall have no liability for the consequences of use of such information.

**Short data sheet** — A short data sheet is an extract from a full data sheet with the same product type number(s) and title. A short data sheet is intended for quick reference only and should not be relied upon to contain detailed and full information. For detailed and full information see the relevant full data sheet, which is available on request via the local Nexperia sales office. In case of any inconsistency or conflict with the short data sheet, the full data sheet shall prevail.

**Product specification** — The information and data provided in a Product data sheet shall define the specification of the product as agreed between Nexperia and its customer, unless Nexperia and customer have explicitly agreed otherwise in writing. In no event however, shall an agreement be valid in which the Nexperia product is deemed to offer functions and qualities beyond those described in the Product data sheet.

### Disclaimers

**Limited warranty and liability** — Information in this document is believed to be accurate and reliable. However, Nexperia does not give any representations or warranties, expressed or implied, as to the accuracy or completeness of such information and shall have no liability for the consequences of use of such information. Nexperia takes no responsibility for the content in this document if provided by an information source outside of Nexperia.

In no event shall Nexperia be liable for any indirect, incidental, punitive, special or consequential damages (including - without limitation - lost profits, lost savings, business interruption, costs related to the removal or replacement of any products or rework charges) whether or not such damages are based on tort (including negligence), warranty, breach of contract or any other legal theory.

Notwithstanding any damages that customer might incur for any reason whatsoever, Nexperia's aggregate and cumulative liability towards customer for the products described herein shall be limited in accordance with the Terms and conditions of commercial sale of Nexperia.

**Right to make changes** — Nexperia reserves the right to make changes to information published in this document, including without limitation specifications and product descriptions, at any time and without notice. This document supersedes and replaces all information supplied prior to the publication hereof.

**Suitability for use** — Nexperia products are not designed, authorized or warranted to be suitable for use in life support, life-critical or safety-critical systems or equipment, nor in applications where failure or malfunction of an Nexperia product can reasonably be expected to result in personal

injury, death or severe property or environmental damage. Nexperia and its suppliers accept no liability for inclusion and/or use of Nexperia products in such equipment or applications and therefore such inclusion and/or use is at the customer's own risk.

**Quick reference data** — The Quick reference data is an extract of the product data given in the Limiting values and Characteristics sections of this document, and as such is not complete, exhaustive or legally binding.

**Applications** — Applications that are described herein for any of these products are for illustrative purposes only. Nexperia makes no representation or warranty that such applications will be suitable for the specified use without further testing or modification.

Customers are responsible for the design and operation of their applications and products using Nexperia products, and Nexperia accepts no liability for any assistance with applications or customer product design. It is customer's sole responsibility to determine whether the Nexperia product is suitable and fit for the customer's applications and products planned, as well as for the planned application and use of customer's third party customer(s). Customers should provide appropriate design and operating safeguards to minimize the risks associated with their applications and products.

Nexperia does not accept any liability related to any default, damage, costs or problem which is based on any weakness or default in the customer's applications or products, or the application or use by customer's third party customer(s). Customer is responsible for doing all necessary testing for the customer's applications and products using Nexperia products in order to avoid a default of the applications and the products or of the application or use by customer's third party customer(s). Nexperia does not accept any liability in this respect.

**Limiting values** — Stress above one or more limiting values (as defined in the Absolute Maximum Ratings System of IEC 60134) will cause permanent damage to the device. Limiting values are stress ratings only and (proper) operation of the device at these or any other conditions above those given in the Recommended operating conditions section (if present) or the Characteristics sections of this document is not warranted. Constant or repeated exposure to limiting values will permanently and irreversibly affect the quality and reliability of the device.

**Terms and conditions of commercial sale** — Nexperia products are sold subject to the general terms and conditions of commercial sale, as published at <http://www.nexperia.com/profile/terms>, unless otherwise agreed in a valid written individual agreement. In case an individual agreement is concluded only the terms and conditions of the respective agreement shall apply. Nexperia hereby expressly objects to applying the customer's general terms and conditions with regard to the purchase of Nexperia products by customer.

**No offer to sell or license** — Nothing in this document may be interpreted or construed as an offer to sell products that is open for acceptance or the grant, conveyance or implication of any license under any copyrights, patents or other industrial or intellectual property rights.

**Export control** — This document as well as the item(s) described herein may be subject to export control regulations. Export might require a prior authorization from competent authorities.

**Non-automotive qualified products** — Unless this data sheet expressly states that this specific Nexperia product is automotive qualified, the product is not suitable for automotive use. It is neither qualified nor tested in accordance with automotive testing or application requirements. Nexperia accepts no liability for inclusion and/or use of non-automotive qualified products in automotive equipment or applications.

In the event that customer uses the product for design-in and use in automotive applications to automotive specifications and standards, customer (a) shall use the product without Nexperia's warranty of the product for such automotive applications, use and specifications, and (b) whenever customer uses the product for automotive applications beyond Nexperia's specifications such use shall be solely at customer's own risk, and (c) customer fully indemnifies Nexperia for any liability, damages or failed product claims resulting from customer design and use of the product for automotive applications beyond Nexperia's standard warranty and Nexperia's product specifications.

**Translations** — A non-English (translated) version of a document is for reference only. The English version shall prevail in case of any discrepancy between the translated and English versions.

### Trademarks

Notice: All referenced brands, product names, service names and trademarks are the property of their respective owners.

## Contents

<b>1. General description</b> .....	<b>1</b>
<b>2. Features and benefits</b> .....	<b>1</b>
<b>3. Ordering information</b> .....	<b>2</b>
<b>4. Marking</b> .....	<b>2</b>
<b>5. Functional diagram</b> .....	<b>3</b>
<b>6. Pinning information</b> .....	<b>4</b>
6.1. Pinning.....	4
6.2. Pin description.....	5
<b>7. Functional description</b> .....	<b>5</b>
<b>8. Limiting values</b> .....	<b>6</b>
<b>9. Recommended operating conditions</b> .....	<b>6</b>
<b>10. Static characteristics</b> .....	<b>7</b>
10.1. Test circuits.....	7
10.2. ON resistance.....	8
10.3. ON resistance test circuit and graphs.....	8
<b>11. Dynamic characteristics</b> .....	<b>10</b>
11.1. Waveforms and test circuit.....	11
11.2. Additional dynamic characteristics.....	13
<b>12. Package outline</b> .....	<b>14</b>
<b>13. Abbreviations</b> .....	<b>19</b>
<b>14. Revision history</b> .....	<b>19</b>
<b>15. Legal information</b> .....	<b>20</b>

© Nexperia B.V. 2025. All rights reserved



For more information, please visit: <http://www.nexperia.com>

For sales office addresses, please send an email to: [salesaddresses@nexperia.com](mailto:salesaddresses@nexperia.com)

Date of release: 13 November 2025

## Looking for pricing, stock, or lifecycle information?

Click below to explore more details on WIN SOURCE:

-  [View 770-203 on WIN SOURCE](#)
-  [WAGO Corporation](#) Information

## Optimize Your Supply Chain with WIN SOURCE Solutions

-  Global Sourcing Solution
-  Obsolete Management
-  Cost Control Management
-  Shortage Management
-  Alternative Solution
-  Excess Inventory Management