



THE DATASHEET OF BSW6440



Product Description

The BSW6440 is an absorptive SP4T 50Ω matched RF switch supporting bandwidths up to 6GHz. Its high linearity performance across the temperature range makes it ideally suited for use in 3G/4G/5G wireless infrastructure and 802.11 a/n/ac/ax applications where high power and excellent performance is required.

The BSW6440 is designed with robust ESD protection circuits at all pins and packaged in an industry standard, fully RoHS2-compliant, 16-Lead, 3mm x 3mm x 0.75mm TQFN package.

The BSW6440 does not require blocking capacitors. If DC is presented at the RF port, add a blocking capacitor.

A functional block diagram is shown in Figure 1.

Block Diagram

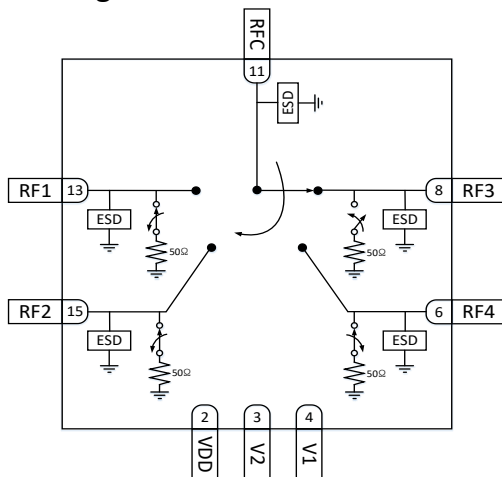

Figure 1 Functional Block Diagram

Applications

- Wireless 3G/4G/5G Infrastructure
- WLAN 802.11 a/n/ac/ax

Package Type



3mm x 3mm x 0.75mm, 16-Lead TQFN Package

Figure 2 Package Type

Device Features

- Output frequency range : 50 MHz to 6.0 GHz
- Supply Voltage : 2.7V to 3.6V
- ESD, HBM
 - : 3.0kV @ RF pins
 - : 2.0kV @ All pins except RF pins
- Constant impedance during switching transition
 - : Return loss 10dB
- Operating temperature range : -40°C to +105°C
- Low Insertion Loss
 - : 0.89dB @ 2.35GHz
 - : 0.87dB @ 3.5GHz
 - : 0.97dB @ 4.9GHz
- High Isolation
 - RFC to RFx
 - : 42dB @ 2.35GHz
 - : 39dB @ 3.5GHz
 - : 35dB @ 4.9GHz
 - RFx to RFx
 - : 41dB @ 2.35GHz
 - : 37dB @ 3.5GHz
 - : 32dB @ 4.9GHz
- High Input 1dB Compression
 - : 40.3dBm @ 2.35GHz
 - : 40.7dBm @ 3.5GHz
 - : 40.6dBm @ 4.9GHz
- High IIP3
 - : 62.5dBm @ 2.35GHz
 - : 62.8dBm @ 3.5GHz
 - : 63.8dBm @ 4.9GHz
- Switching Time : 420 to 425ns
- 16-Lead TQFN package : 3.0mm x 3.0mm x 0.75mm
- Lead-free/RoHS2-compliant TQFN SMT package

Electrical Specifications

Typical conditions are at VDD = 3.3V, T_A = 25°C, V1/V2 Low = 0V, V1/V2 High = 3.3V, Z_L = 50Ω, Excluding SMA Connector and PCB loss⁽¹⁾, unless otherwise noted.

Table 1.1 Electrical Specifications (Cont.)

Parameter	Path	Condition	Min	Typ	Max	Unit
Operating Frequency			50		6000	MHz
Insertion Loss	RFC - RF1	1GHz		0.77		dB
		2GHz		0.85		
		3GHz		0.88		
		4GHz		0.83		
		5GHz		1.04		
		6GHz		1.29		
	RFC - RF2	1GHz		0.81		dB
		2GHz		0.88		
		3GHz		0.91		
		4GHz		0.84		
		5GHz		1.02		
		6GHz		1.17		
	RFC - RF3	1GHz		0.79		dB
		2GHz		0.86		
		3GHz		0.90		
		4GHz		0.84		
5GHz			1.02			
6GHz			1.26			
RFC - RF4	1GHz		0.80		dB	
	2GHz		0.88			
	3GHz		0.93			
	4GHz		0.85			
	5GHz		1.05			
	6GHz		1.24			
Return Loss (Active port)	RFC,RFx	50MHz—6GHz		15		dB
Return Loss (Terminated port)	RFC,RFx	50MHz—6GHz		15		dB
Return Loss (during switching transition)	RFC,RFx	50MHz – 6GHz		10		dB

The typical spurious performance of the BSW6440 is -115dBm / 10Hz @ Over 10MHz

(1) Excluding SMA Connector and PCB loss.

Table 1.2 Electrical Specifications

Parameter	Path	Condition	Min	Typ	Max	Unit
Input P1dB	RFC - RFx	2.35GHz		40.3		dBm
		3.5GHz		40.7		
		4.9GHz		40.6		
		5.75GHz		39.9		
Input IP2 ⁽²⁾	RFC - RFx	2.35GHz		110.8		dBm
		3.5GHz		109.1		
		4.9GHz		108.8		
		5.75GHz		105.4		
Input IP3 ⁽²⁾	RFC - RFx	2.35GHz		62.5		dBm
		3.5GHz		62.8		
		4.9GHz		63.8		
		5.75GHz		64.1		
2 nd Harmonic ⁽³⁾	RFC - RFx	2.35GHz		98.7		dBc
		3.5GHz		96.4		
		4.9GHz		98.2		
		5.75GHz		93.4		
3 rd Harmonic ⁽³⁾	RFC - RFx	2.35GHz		99.1		dBc
		3.5GHz		99.1		
		4.9GHz		100.8		
		5.75GHz		100.8		
Switching Time	RFC - RFx	50% control to 90% RF		425		ns
		50% control to 10% RF		420		
Settling Time	RFC - RFx	50% CTRL to 0.05dB final value Rising Edge		440		ns
		50% CTRL to 0.05dB final value Falling Edge		425		

(2) Tone Power is 18dBm and Tone spacing is 20KHz .

(3) Tone Power is 18dBm.

High Isolation Absorptive SP4T RF Switch

50MHz-6000MHz

Isolation Matrix

Typical conditions are at VDD = 3.3V, T_A = 25°C, V1/V2 Low = 0V, V1/V2 High = 3.3V, Z_L = 50Ω, Excluding SMA Connector and PCB loss, unless otherwise noted.

Table 2 RFC-to-RFx Isolation

"ON" Port	Frequency	Isolation				Unit
		RF1	RF2	RF3	RF4	
RF1	1GHz	-	74	53	67	dB
	2GHz	-	62	48	62	
	3GHz	-	52	44	58	
	4GHz	-	45	42	53	
	5GHz	-	41	38	47	
	6GHz	-	37	36	42	
RF2	1GHz	50	-	52	71	
	2GHz	45	-	47	64	
	3GHz	43	-	44	56	
	4GHz	41	-	41	51	
	5GHz	38	-	38	45	
	6GHz	35	-	36	41	
RF3	1GHz	50	66	-	73	
	2GHz	44	61	-	62	
	3GHz	41	57	-	53	
	4GHz	38	52	-	46	
	5GHz	36	46	-	41	
	6GHz	33	41	-	37	
RF4	1GHz	49	71	54	-	
	2GHz	43	63	49	-	
	3GHz	40	56	48	-	
	4GHz	38	49	45	-	
	5GHz	35	44	39	-	
	6GHz	33	39	38	-	

Table 3 RFx-to-RFx Isolation

"ON" Port	Frequency	Isolation				Unit
		RF1	RF2	RF3	RF4	
RF1	1GHz	-	48	67	67	dB
	2GHz	-	42	57	64	
	3GHz	-	38	50	63	
	4GHz	-	35	44	59	
	5GHz	-	32	41	51	
	6GHz	-	29	38	46	
RF2	1GHz	53	-	62	63	
	2GHz	44	-	54	59	
	3GHz	38	-	48	59	
	4GHz	33	-	44	58	
	5GHz	29	-	41	53	
	6GHz	26	-	38	48	
RF3	1GHz	59	68	-	49	
	2GHz	52	64	-	42	
	3GHz	46	65	-	38	
	4GHz	42	58	-	35	
	5GHz	39	51	-	32	
	6GHz	36	46	-	29	
RF4	1GHz	57	64	52	-	
	2GHz	50	60	44	-	
	3GHz	45	60	38	-	
	4GHz	41	58	33	-	
	5GHz	39	53	30	-	
	6GHz	36	48	27	-	

Product Description

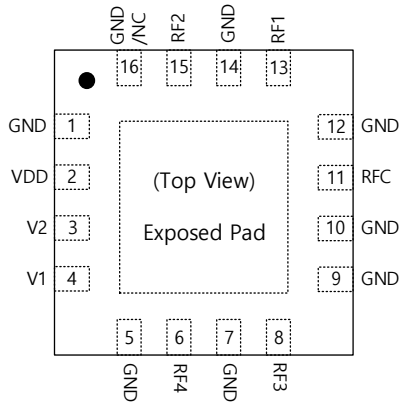

Figure 3 Pin Description

Table 4 Pin Descriptions

No.	Pin Name	Descriptions
2	VDD	Supply Voltage
3	V2	Switch control input (Definition for the V2 pin, See Table5)
4	V1	Switch control input (Definition for the V1 pin, See Table5)
6	RF4	RF4 Port
8	RF3	RF3 Port
11	RFC	RFC Port
13	RF1	RF1 Port
15	RF2	RF2 Port
16	GND/NC	Pin16 can be grounded or left unconnected externally
1,5,7,9,10,12,14	GND	Ground
Pad	Exposed Pad	Ground

Table 5 Control Truth Table

V1	V2	RFC-RF1	RFC-RF2	RFC-RF3	RFC-RF4
0	0	ON	OFF	OFF	OFF
0	1	OFF	ON	OFF	OFF
1	0	OFF	OFF	ON	OFF
1	1	OFF	OFF	OFF	ON

Table 6 Operating Ranges

Parameter	Symbol	Min	Typ	Max	Unit
Supply Voltage	VDD	2.7	3.3	3.6	V
Supply Current	IDD	-	180	-	μA
Digital Input Control (V1/V2)	High	1.0	-	3.3	V
	Low	0	-	0.7	V
Operating Temperature Range	To	-40	+25	+105	°C
RF Input Power, CW (Active Port) 2.35GHz, 3.5GHz, 4.9GHz (any port)	P _{Max,Active}	-	-	36	dBm
RF Input Power, CW (Terminated Port) 2.35GHz, 3.5GHz, 4.9GHz (RFx port)	P _{Max,Term}	-	-	26	dBm

*Specifications are not guaranteed over all recommended operating conditions.

Table 7 Absolute Maximum Ratings

Parameter	Symbol	Min	Max	Unit	
Supply Voltage	VDD	-0.3	3.6	V	
Digital Input Voltage	V1/V2	-0.3	3.6	V	
Maximum Input Power, CW (+25°C)	-	-	Input P1dB	dBm	
Storage Temperature range	-	-65	+150	°C	
ESD	HBM	RF pins	-	3000	V
		All pins	-	2000	V
	CDM	All pins	-	1000	V

Typical Performances (Cont.)

Typical conditions are at VDD = 3.3V, T_A = 25°C, V1/V2 Low = 0V, V1/V2 High = 3.3V, Z_L = 50Ω, Excluding SMA Connector and PCB loss, unless otherwise noted.

Figure 4 Insertion Loss vs Frequency

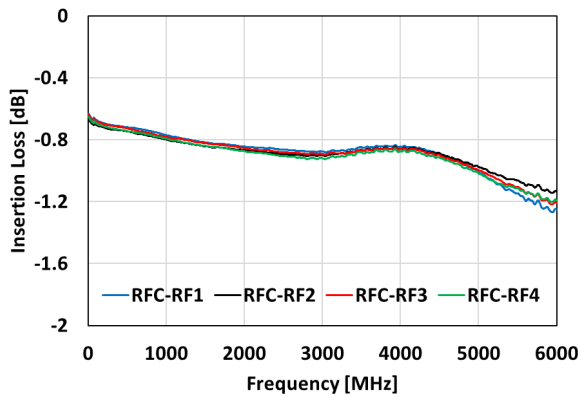

Figure 5 Insertion Loss vs VDD (RFC-RF1)

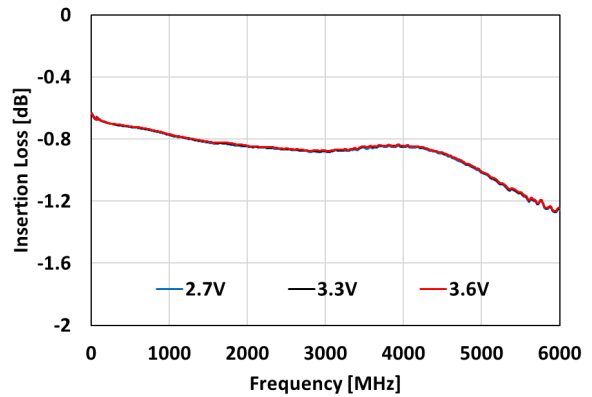

Figure 6 Insertion Loss vs Temp (RFC-RF1)

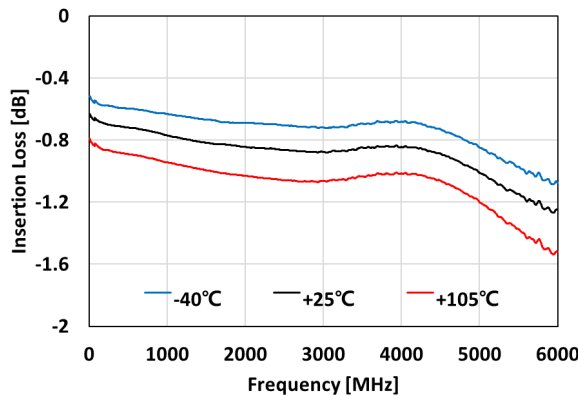

Figure 7 Return Loss vs Frequency (RFC Port)

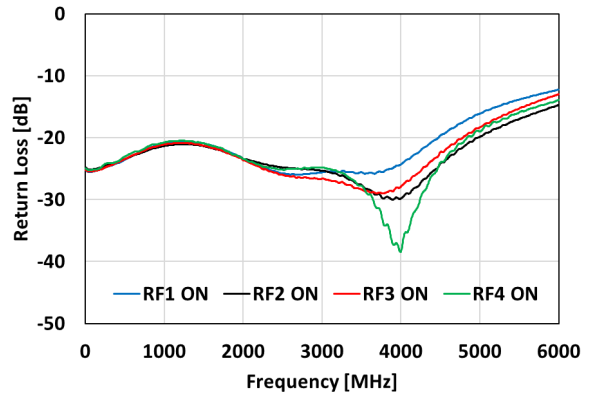

Figure 8 Return Loss vs VDD (RFC Port / RF1 ON)

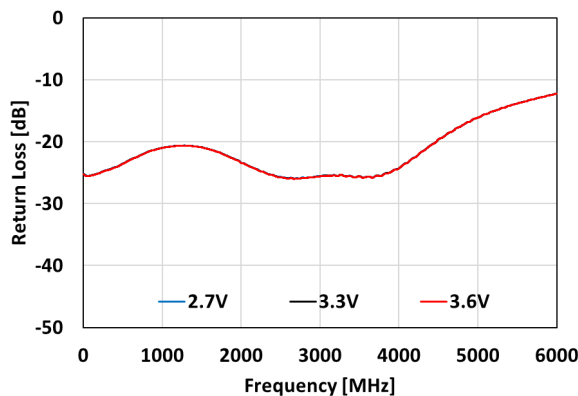
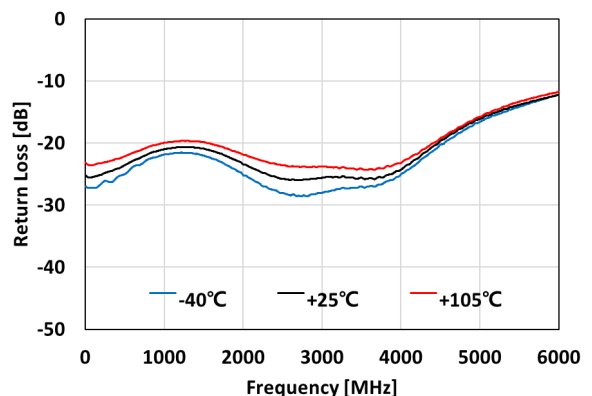
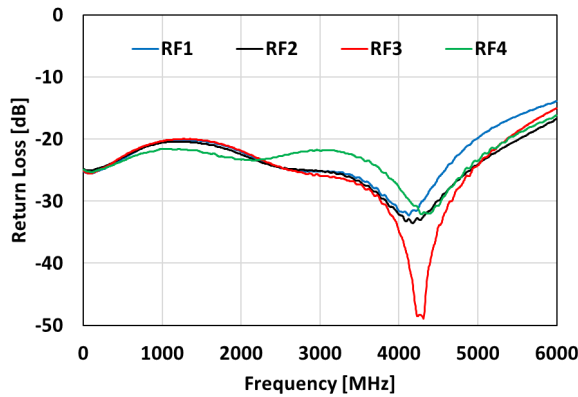
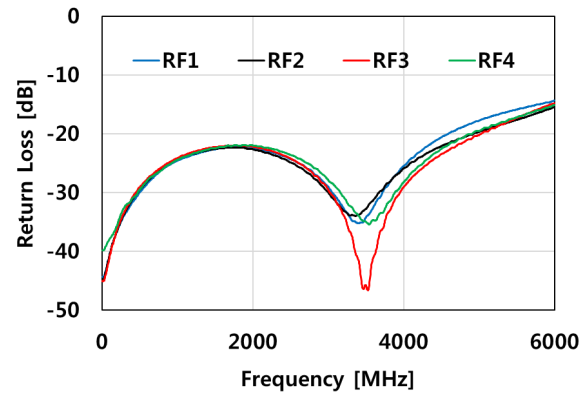
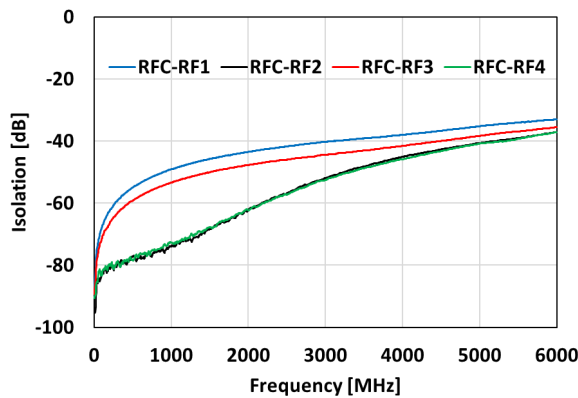
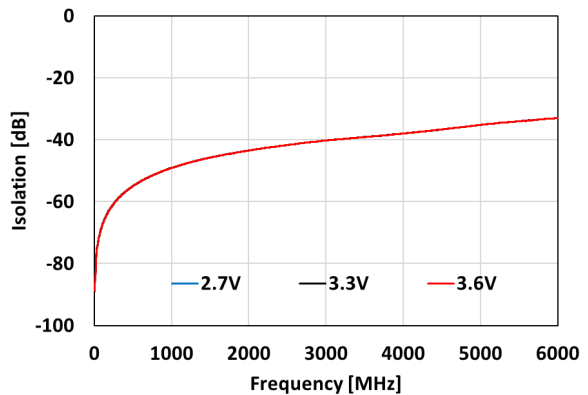
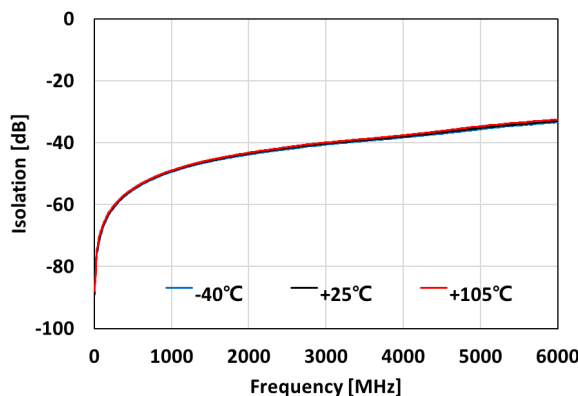
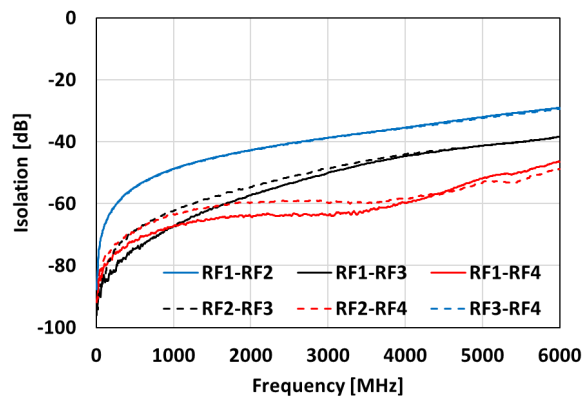

Figure 9 Return Loss vs Temp (RFC Port / RF1 ON)



Typical Performances (Cont.)

Typical conditions are at VDD = 3.3V, T_A = 25°C, V1/V2 Low = 0V, V1/V2 High = 3.3V, Z_L = 50Ω, Excluding SMA Connector and PCB loss, unless otherwise noted.

Figure 10 Return Loss vs Frequency (Active Port)

Figure 11 Return Loss vs Frequency (Term. Port)

Figure 12 Isolation vs Frequency (C to X)

Figure 13 Isolation vs VDD (RFC-RF1)

Figure 14 Isolation vs Temp (RFC to RF1)

Figure 15 Isolation vs Frequency (X to X)

Typical Performances

Typical conditions are at VDD = 3.3V, T_A = 25°C, V1/V2 Low = 0V, V1/V2 High = 3.3V, Z_L = 50Ω, Excluding SMA Connector and PCB loss, unless otherwise noted.

Figure 16 Isolation vs VDD (RF1 to RF2)

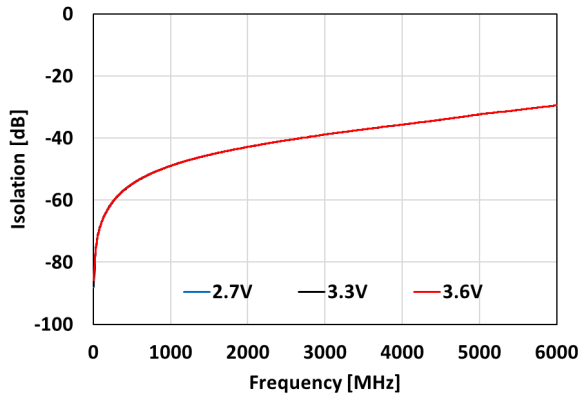

Figure 17 Isolation Temp (RF1 to RF2)

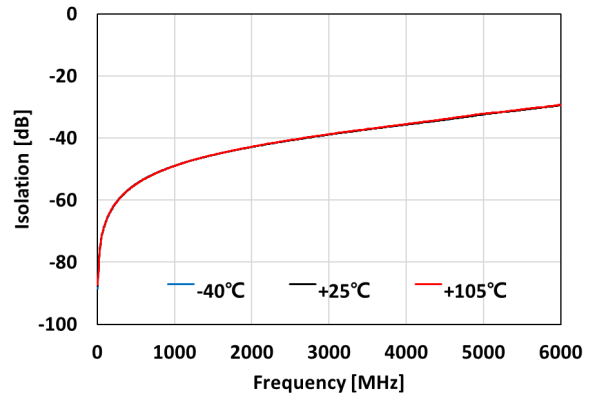

Figure 18 IIP2 vs Port Measured

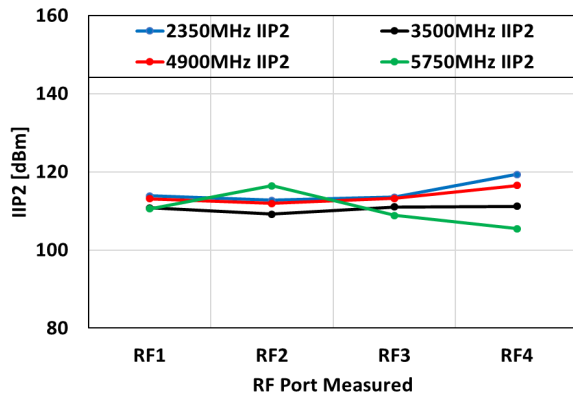

Figure 19 IIP3 vs Port Measured

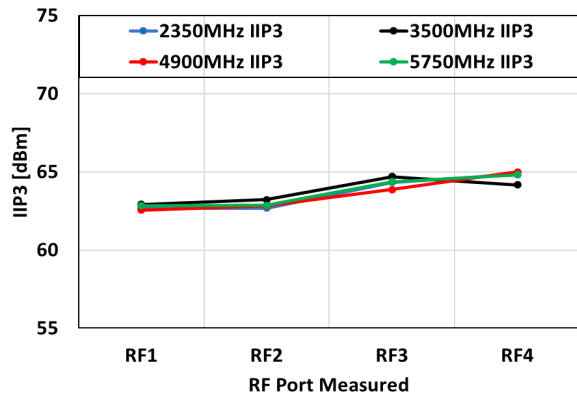

Figure 20 2nd Harmonic vs Port Measured

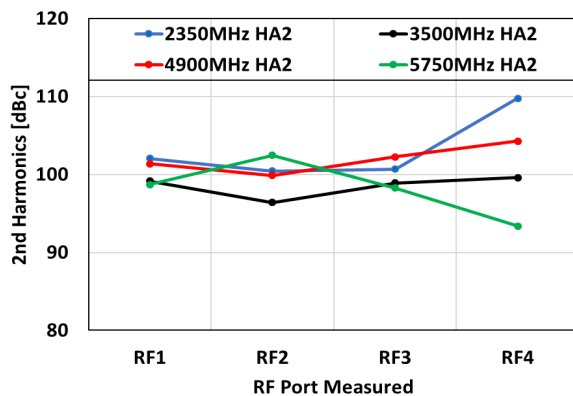
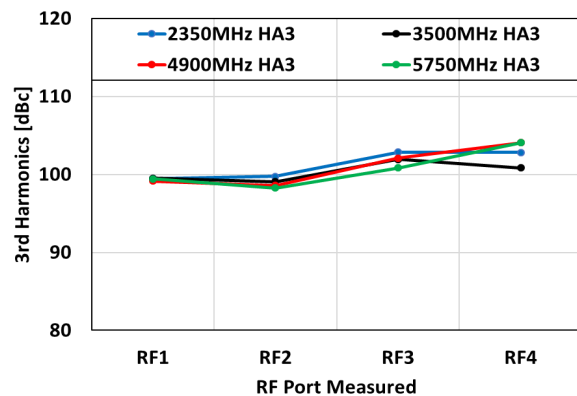

Figure 21 3rd Harmonic vs Port Measured



Evaluation Board

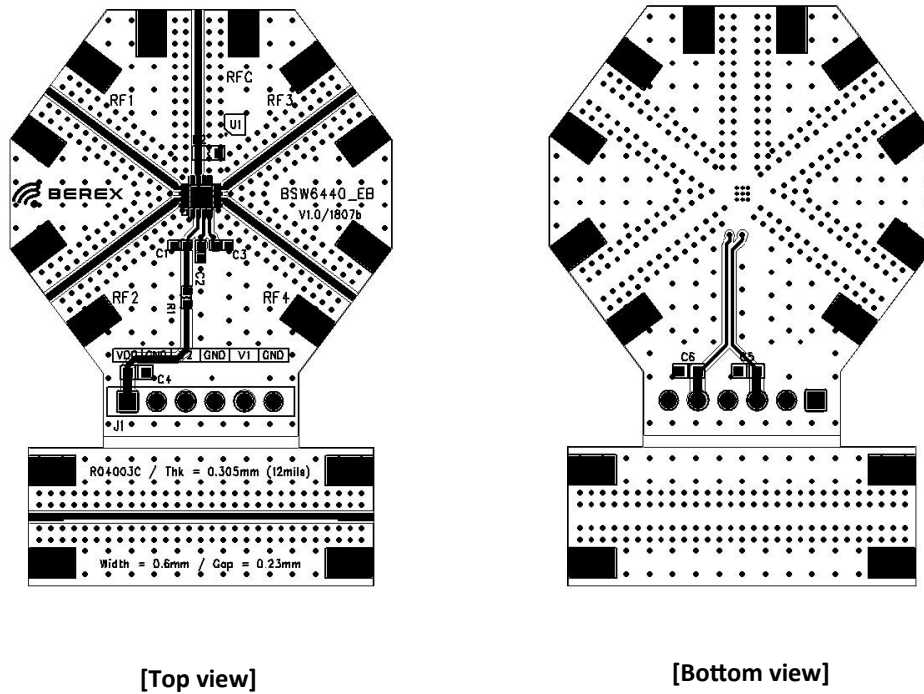

Figure 22 Evaluation Board Layout

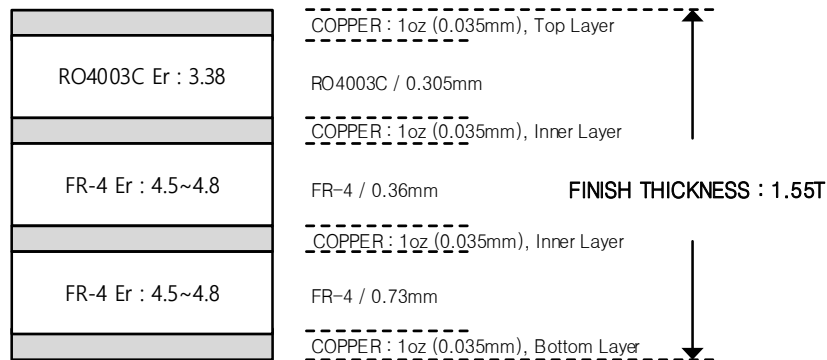

Figure 23 Evaluation Board PCB Layer Information

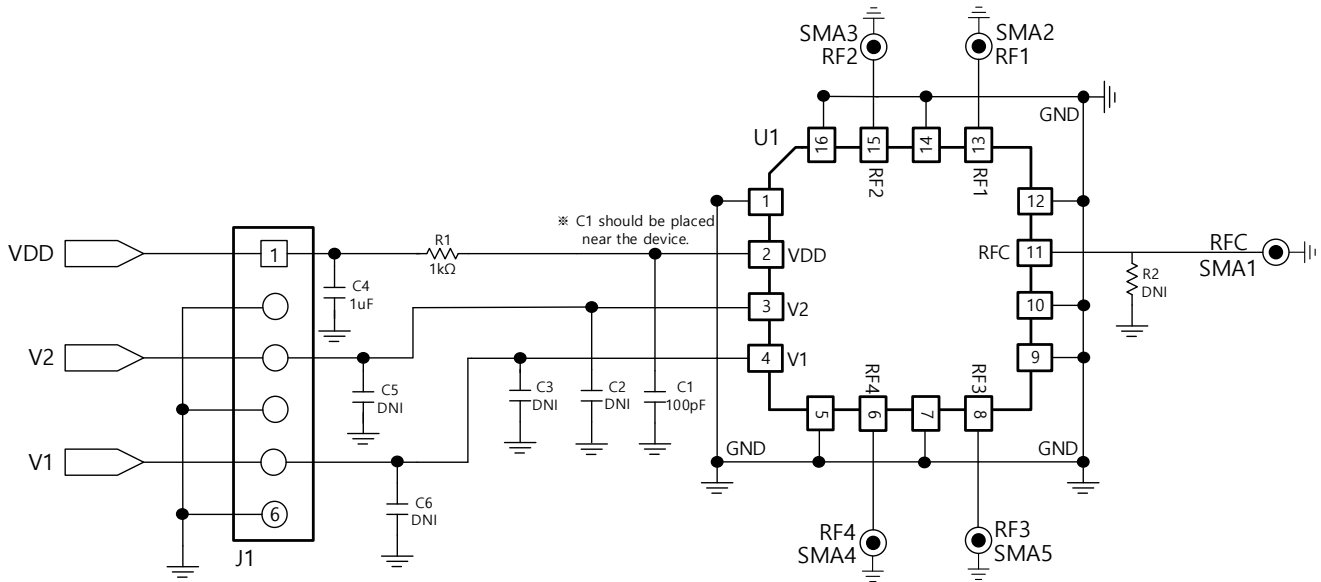

Figure 24 Evaluation Board Schematic

Table 8 Bill of Material - Evaluation Board

No.	Ref Des	Part Qty	Part Number	Remark
1	C1	1	CAP 1005 100pF J 50V	C1 should be placed near the BSW6440
2	C2,C3	2	CAP 1005 DNI	
3	R1	1	RES 1005 J 1Kohm	
4	C4	1	CAP 1608 1uF 50V	
5	C5, C6	2	CAP 1608 DNI	
6	J1	1	6 Pin Header	
7	R2	1	RES 1608 DNI	
8	RFC, RF1, RF2, RF3, RF4	5	SMA_END_LAUNCH	
9	U1	1	BSW6440	

High Isolation SPDT Mode Application

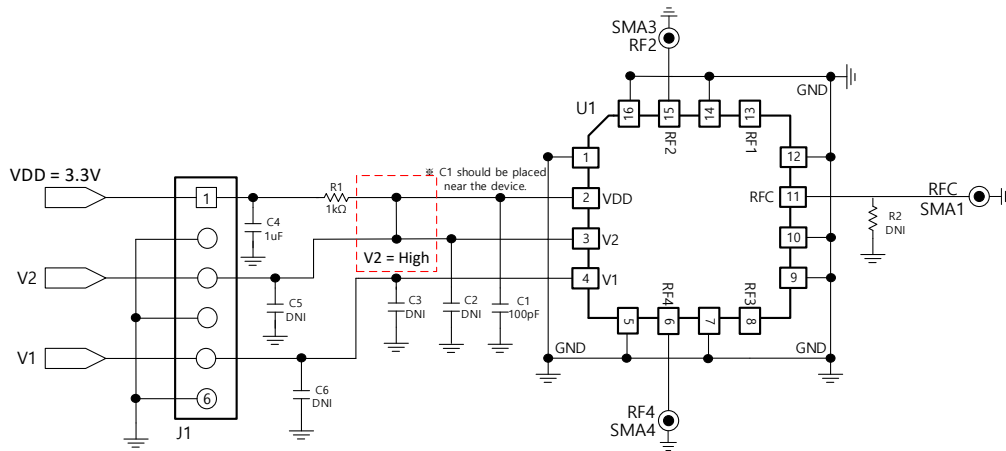
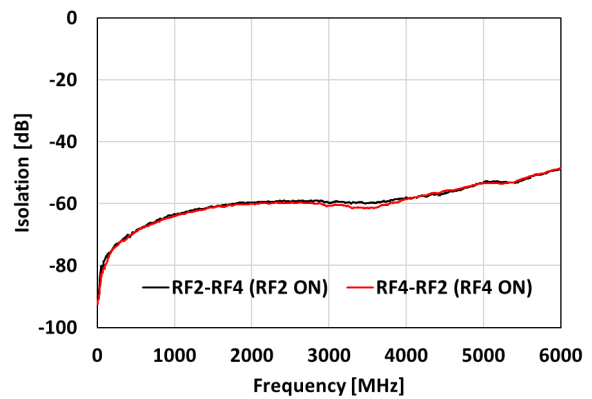
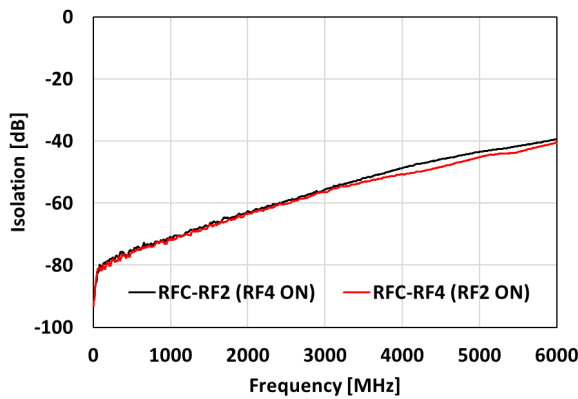

Figure 25 Application Circuit

Table 9 Control Truth Table

V1	V2	RFC-RF2	RFC-RF4
0	1	ON	OFF
1	1	OFF	ON



"ON" Port	Frequency	Isolation		Unit
		RF2	RF4	
RF2	1GHz	-	71	dB
	2GHz	-	64	
	3GHz	-	56	
	4GHz	-	51	
	5GHz	-	45	
	6GHz	-	41	
RF4	1GHz	71	-	
	2GHz	63	-	
	3GHz	56	-	
	4GHz	49	-	
	5GHz	44	-	
	6GHz	39	-	

Figure 26 RFC to RFX Isolation

"ON" Port	Frequency	Isolation		Unit
		RF2	RF4	
RF2	1GHz	-	63	dB
	2GHz	-	59	
	3GHz	-	59	
	4GHz	-	58	
	5GHz	-	53	
	6GHz	-	48	
RF4	1GHz	64	-	
	2GHz	60	-	
	3GHz	60	-	
	4GHz	58	-	
	5GHz	53	-	
	6GHz	48	-	

Figure 27 RFX to RFX Isolation

Package Outline Drawing

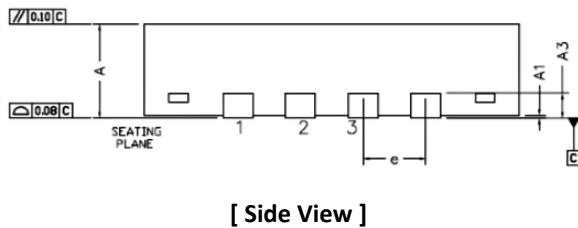
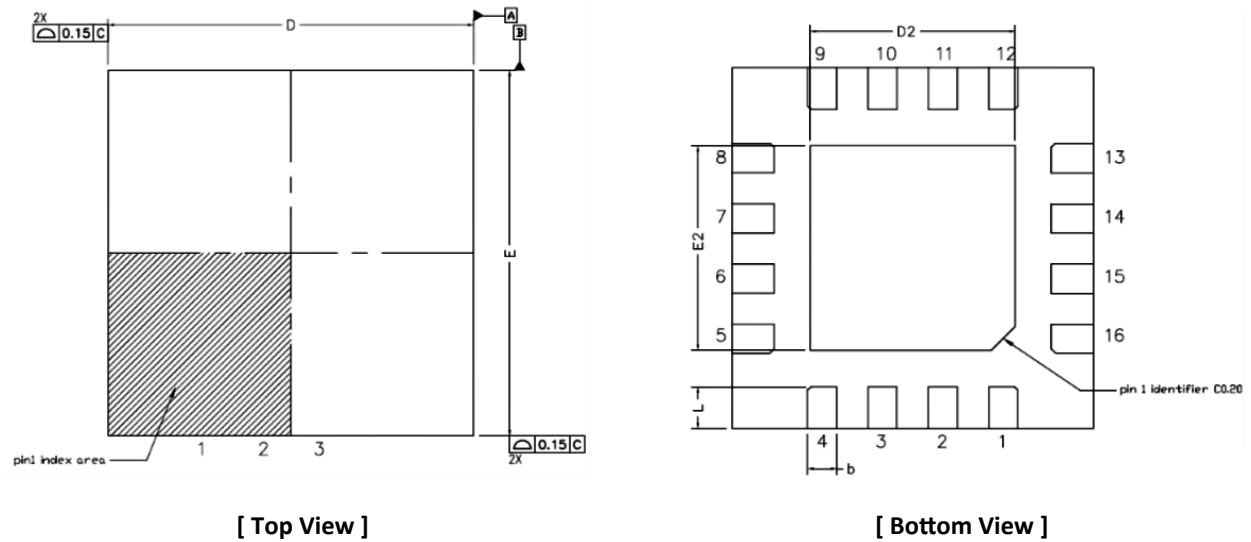

DIMENSIONS	Common					
	DIMENSIONS MILLIMETER			DIMENSIONS INCH		
	MIN.	NOM.	MAX.	MIN.	NOM.	MAX.
A	0.70	0.75	0.80	0.028	0.030	0.031
A1	0.00	0.02	0.05	0.000	0.001	0.002
A3	0.203 REF			0.008 REF		
b	0.18	0.24	0.30	0.007	0.009	0.012
D	2.90	3.00	3.10	0.114	0.118	0.122
E	2.90	3.00	3.10	0.114	0.118	0.122
D2	1.65	1.70	1.75	0.065	0.067	0.069
E2	1.65	1.70	1.75	0.065	0.067	0.069
e	0.50 BSC.			0.020 BSC.		
L	0.30	0.35	0.40	0.012	0.014	0.016

Figure 28 Package Outline Drawing

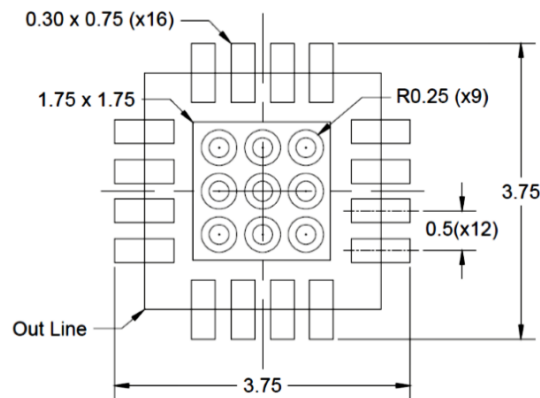
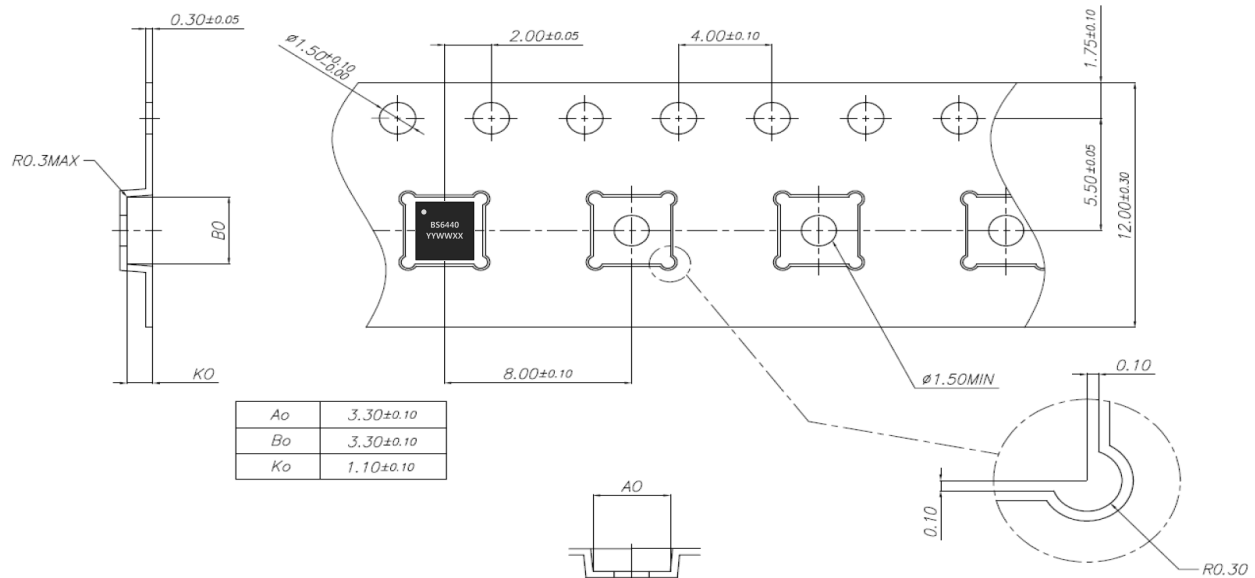

Figure 29 Recommended Land Pattern

Tape & Reel



Packaging information:	
Tape Width	12mm
Reel Size	7inch
Device Cavity Pitch	8mm
Device Per Reel	1000EA

Figure 30 Tape & Reel

Package Marking

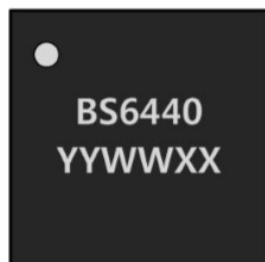

Marking information:	
BS	BeRex RF Switch
6440	The name of switch
YY	Year
WW	Work Week
XX	Wafer Lot Number

Figure 31 Package Marking

Lead plating finish
100% Tin Matte finish

(All BeRex products undergoes a 1 hour, 150 degree C, Anneal bake to eliminate thin whisker growth concerns.)

MSL / ESD Rating

ESD information1 :	
Rating	Class 2 (2000V)
Test	Human Body Model (HBM)
Standard	JS-001-2017

ESD information2 :	
Rating	Class C3 (1000V)
Test	Charged Device Model (CDM)
Standard	JS-001-2017

MSL information:	
Rating	Level 1 at +260°C convection reflow
Standard	JEDEC Standard J-STD-020



Proper ESD procedures should be followed when handling the device.

RoHS Compliance

This part is compliant with Restrictions on the use of certain Hazardous Substances in Electrical and Electronic Equipment (RoHS) Directive 2011/65/EU as amended by Directive 2015/863/EU.



This product also is compliant with a concentration of the Substances of Very High Concern (SVHC) candidate list which are contained in a quantity of less than 0.1%(w/w) in each components of a product and/or its packaging placed on the European Community market by the BeRex and Suppliers.

NATO CAGE code:

2	N	9	6	F
----------	----------	----------	----------	----------

Looking for pricing, stock, or lifecycle information?

Click below to explore more details on WIN SOURCE:

-  [View BSW6440 on WIN SOURCE](#)
-  [BeRex Corporation Information](#)

Optimize Your Supply Chain with WIN SOURCE Solutions

-  Global Sourcing Solution
-  Obsolete Management
-  Cost Control Management
-  Shortage Management
-  Alternative Solution
-  Excess Inventory Management