



**THE DATASHEET OF
CYPD5125-40LQXI**





ISA-PLAN® // PRECISION RESISTORS

FMK // Size 1206

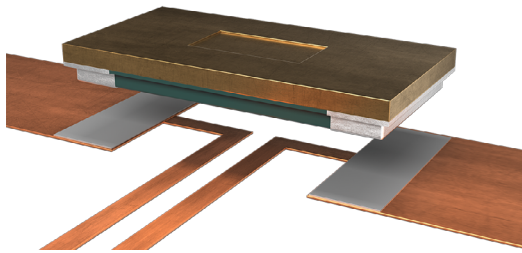

Features

- Power rating up to 3.5 W at 70 °C (2 mOhm)
- Constant current up to 41 A (2 mOhm)
- Small size (1206)
- High pulse power rating
- Excellent long-term stability
- Mounting: Reflow- and IR-soldering / vacuum soldering recommended
- AEC-Q200 qualification
- RoHS 2011/65/EU compliant



Applications

- Current sensor for power hybrid applications
- Control systems for the automotive market
- Power modules
- Frequency converters
- Switch mode power supplies

Technical data

Resistance values	mOhm	2 / 3 / 4 / 5 / 6
Tolerance	%	1 / 5 / 10
Temperature coefficient (20-60 °C)	ppm/K	<50
Applicable temperature range	°C	-65 to +170
Power rating	W	up to 3.5
Dielectric withstanding voltage	V AC/DC	200
Inductance	nH	<1
Stability (at rated power) deviation after 2000h, T _K = Terminal temperature		< 0.5 % (TK=80 °C) < 1.0 % (TK=110 °C)

Type	Value [mΩ]	Rthi [K/W]	TCR (20-60 °C) [ppm/K]	P _{70°C} [W]	P _{110°C} [W]	Available tolerances		
						1 %	5 %	10 %
FMK-M-R002	2	<26	<50	3.5	2	✓	✓	
FMK-M-R003	3	<34	<50	3	1.5	✓	✓	
FMK-V-R004	4	<42	<50	2	1.5	✓	✓	✓
FMK-V-R005	5	<50	<50	2	1	✓	✓	
FMK-V-R006	6	<58	<50	1.5	1	✓	✓	

Abbreviation type M=MANGANIN®, V=NOVENTIN®

Ordering code

FMK - M - R002 - 1.0

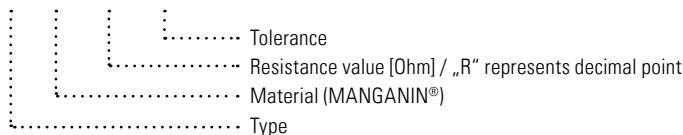



FMK // Size 1206

Recommended solder profile

Reflow- and vacuum soldering

Temperature	°C	260	255	217
Time	sec	peak	40	90

Tape and reel information

Specification		DIN EN 60286-3		
Tape width	mm	8		
Reel size	inch	13		
Parts per reel	pcs	12500		
Packaging weight net	g	454		

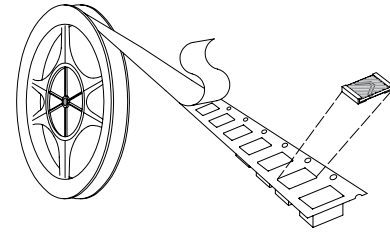

Information

Parts are currently not marked

Mechanical dimensions and pcb-layout proposal (Reflow-soldering) [mm] / Drawing Z-YL-258b

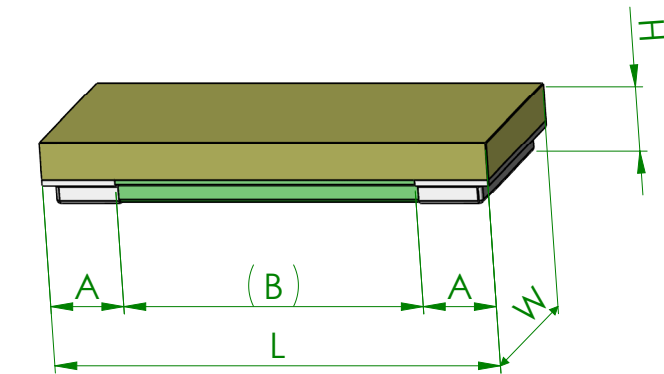

L	W	H	A	B
3.05 ±0.2	1.52 ±0.2	0.4 ±0.2	0.5 ±0.2	(2.05)

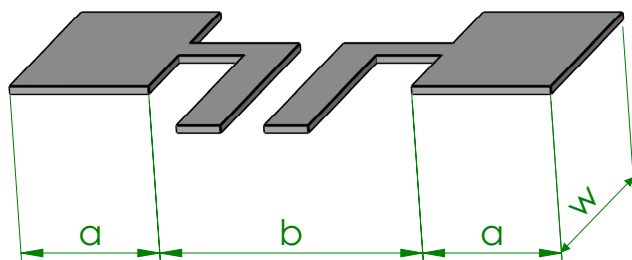

a	b	w
1.00	1.80	1.65

Recommended copper layer thickness 105µm



FMK // Size 1206

Temperature dependence of the electrical resistance of MANGANIN® resistors

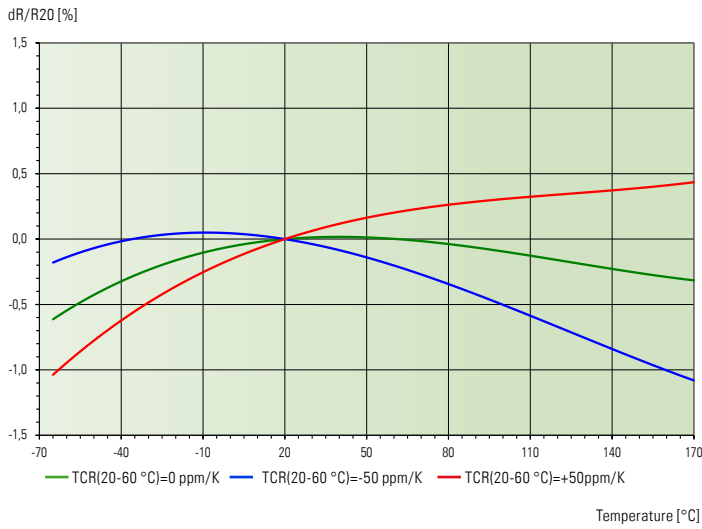

Temperature dependence of the electrical resistance of NOVENTIN® resistors

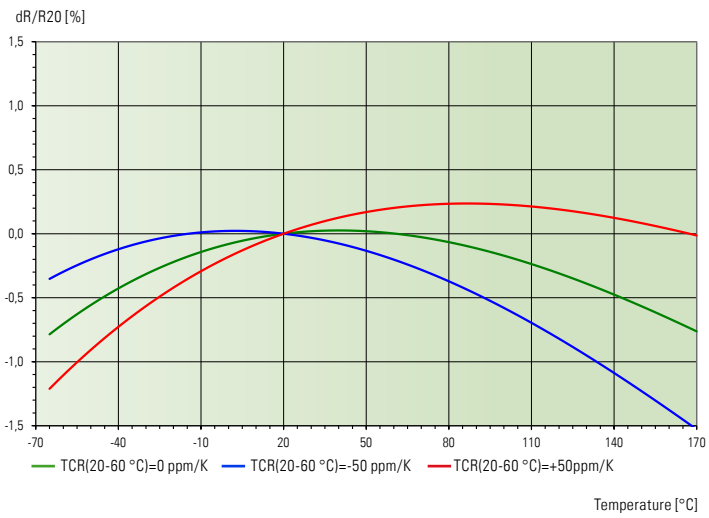

Power derating curve

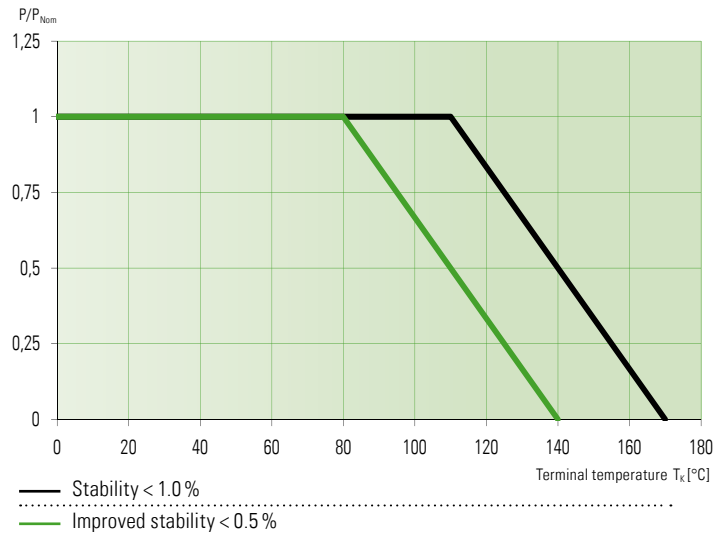



FMK // Size 1206

Maximum pulse energy respectively pulse power for permanent operation

FMK-M-R002; FMK-V-R004; FMK-V-R006
 Maximum pulse energy / power continuous operation ($T_K = 110\text{ °C}$)

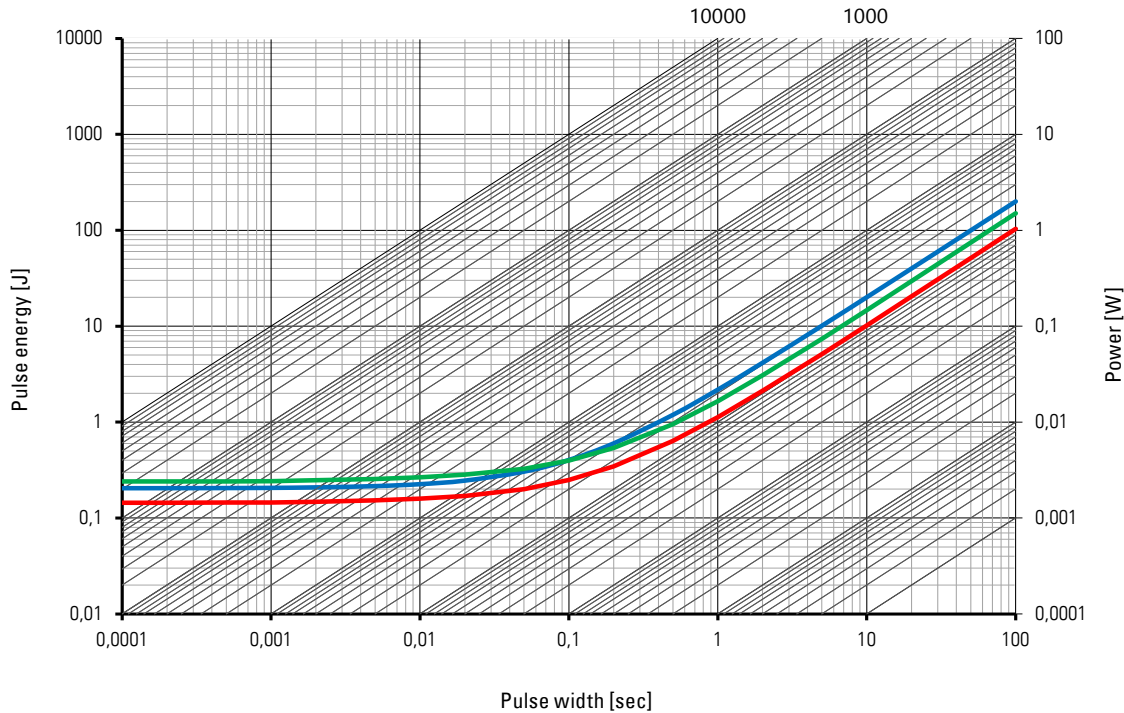

Specification

Parameters	Test conditions	Specified values
Temperature Cycling	1000 cycles (-55 °C to +150 °C)	±0.5%
Low Temperature Storage	-65 °C for 250 h	±0.1%
Moisture Resistance	MIL-STD-202 method 106	±0.5%
Mechanical Shock	100 g, 6 ms half sine	±0.2%
Vibration, High Frequency	10 g, 10-2000 Hz, 24 h each axis	±0.2%
Operational Life	2000 h, $T_K = 110\text{ °C}$ at rated power	±1.0%
High Temperature Exposure	2000 h at 140 °C	±0.5%
	2000 h at 170 °C	±1.0%
Bias Humidity	+85 °C, 85 r.F., 1000 h, powered	±0.5%

Disclaimer // All products, product specifications and data are subject to change without notice.

The product specifications do not expand or otherwise modify Isabellenhütte's terms and conditions of sale, including but not limited to, the warranty expressed therein. Isabellenhütte makes no warranty, representation or guarantee other than as set forth in its terms and conditions of sale.

Information provided in datasheets and/or specifications may vary from actual results in different applications. Any statements made by Isabellenhütte regarding the suitability of products for certain types of applications are based on its knowledge of typical requirements that are often placed on its products. It is the customer's responsibility to validate that a particular product with the properties described in the product specification is suitable for use in the application intended.

No license, express or implied, or otherwise, to any intellectual property rights is granted by this document. Any and all liability arising out of the application or use of any product shall be as set forth in Isabellenhütte's terms and conditions of sale.



Looking for pricing, stock, or lifecycle information?

Click below to explore more details on WIN SOURCE:

 [View CYPD5125-40LQXI on WIN SOURCE](#)

 [Infineon Technologies](#) Information

Optimize Your Supply Chain with WIN SOURCE Solutions

-  Global Sourcing Solution
-  Obsolete Management
-  Cost Control Management
-  Shortage Management
-  Alternative Solution
-  Excess Inventory Management