



Is Now Part of



ON Semiconductor®

To learn more about ON Semiconductor, please visit our website at
www.onsemi.com

Please note: As part of the Fairchild Semiconductor integration, some of the Fairchild orderable part numbers will need to change in order to meet ON Semiconductor's system requirements. Since the ON Semiconductor product management systems do not have the ability to manage part nomenclature that utilizes an underscore (_), the underscore (_) in the Fairchild part numbers will be changed to a dash (-). This document may contain device numbers with an underscore (_). Please check the ON Semiconductor website to verify the updated device numbers. The most current and up-to-date ordering information can be found at www.onsemi.com. Please email any questions regarding the system integration to Fairchild_questions@onsemi.com.

ON Semiconductor and the ON Semiconductor logo are trademarks of Semiconductor Components Industries, LLC dba ON Semiconductor or its subsidiaries in the United States and/or other countries. ON Semiconductor owns the rights to a number of patents, trademarks, copyrights, trade secrets, and other intellectual property. A listing of ON Semiconductor's product/patent coverage may be accessed at www.onsemi.com/site/pdf/Patent-Marking.pdf. ON Semiconductor reserves the right to make changes without further notice to any products herein. ON Semiconductor makes no warranty, representation or guarantee regarding the suitability of its products for any particular purpose, nor does ON Semiconductor assume any liability arising out of the application or use of any product or circuit, and specifically disclaims any and all liability, including without limitation special, consequential or incidental damages. Buyer is responsible for its products and applications using ON Semiconductor products, including compliance with all laws, regulations and safety requirements or standards, regardless of any support or applications information provided by ON Semiconductor. "Typical" parameters which may be provided in ON Semiconductor data sheets and/or specifications can and do vary in different applications and actual performance may vary over time. All operating parameters, including "Typicals" must be validated for each customer application by customer's technical experts. ON Semiconductor does not convey any license under its patent rights nor the rights of others. ON Semiconductor products are not designed, intended, or authorized for use as a critical component in life support systems or any FDA Class 3 medical devices or medical devices with a same or similar classification in a foreign jurisdiction or any devices intended for implantation in the human body. Should Buyer purchase or use ON Semiconductor products for any such unintended or unauthorized application, Buyer shall indemnify and hold ON Semiconductor and its officers, employees, subsidiaries, affiliates, and distributors harmless against all claims, costs, damages, and expenses, and reasonable attorney fees arising out of, directly or indirectly, any claim of personal injury or death associated with such unintended or unauthorized use, even if such claim alleges that ON Semiconductor was negligent regarding the design or manufacture of the part. ON Semiconductor is an Equal Opportunity/Affirmative Action Employer. This literature is subject to all applicable copyright laws and is not for resale in any manner.

KA5x03xx-SERIES

KA5H0365R, KA5M0365R, KA5L0365R
KA5H0380R, KA5M0380R, KA5L0380R
Fairchild Power Switch(FPS)

Features

- Precision Fixed Operating Frequency (100/67/50kHz)
- Low Start-up Current(Typ. 100uA)
- Pulse by Pulse Current Limiting
- Over Current Protection
- Over Voltage Protection (Min. 25V)
- Internal Thermal Shutdown Function
- Under Voltage Lockout
- Internal High Voltage Sense FET
- Auto-Restart Mode

Applications

- SMPS for VCR, SVR, STB, DVD & DVCD
- SMPS for Printer, Facsimile & Scanner
- Adaptor for Camcorder

Description

The Fairchild Power Switch(FPS) product family is specially designed for an off-line SMPS with minimal external components. The Fairchild Power Switch(FPS) consists of a high voltage power SenseFET and a current mode PWM IC. Included PWM controller integrates the fixed frequency oscillator, the under voltage lock-out, the leading edge blanking, the optimized gate turn-on/turn-off driver, the thermal shutdown protection, the over voltage protection, and the temperature compensated precision current sources for the loop compensation and the fault protection circuitry. Compared to a discrete MOSFET and a PWM controller or an RCCsolution, a Fairchild Power Switch(FPS) can reduce the total component count, design size and weight and at the same time increase efficiency, productivity, and system reliability. It has a basic platform well suited for the cost effective design in either a flyback converter or a forward converter

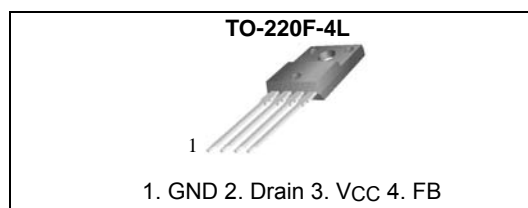

Internal Block Diagram

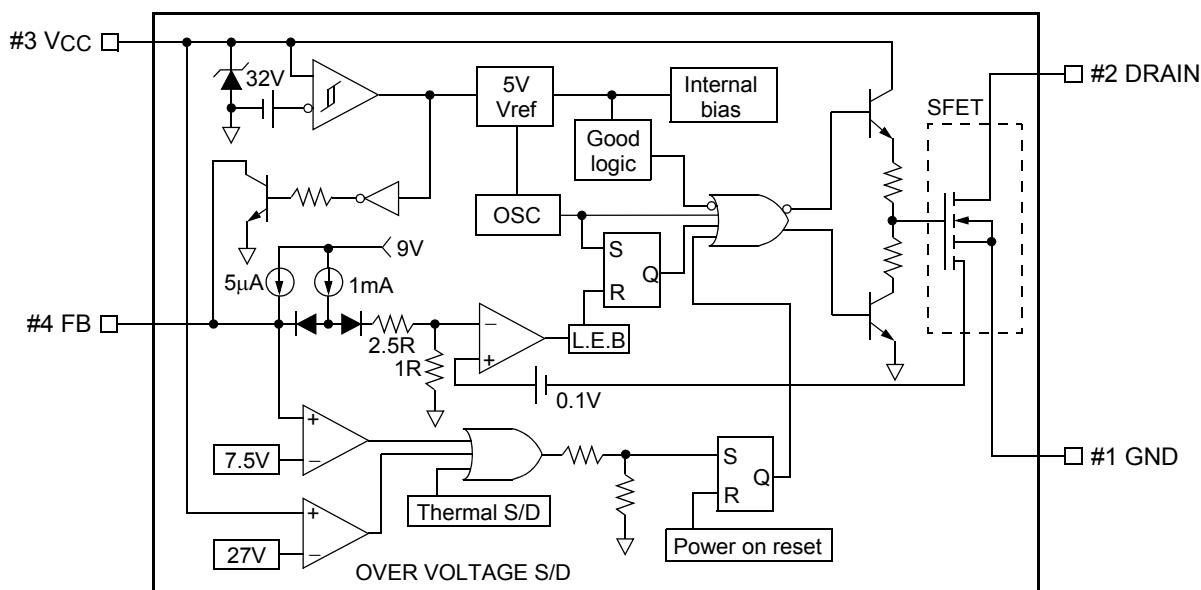

Rev.1.0.7

Absolute Maximum Ratings

(Ta=25°C, unless otherwise specified)

Characteristic	Symbol	Value	Unit
KA5H0365R, KA5M0365R, KA5L0365R			
Drain-Gate Voltage (R _{GS} =1MΩ)	V _{DGR}	650	V
Gate-Source (GND) Voltage	V _{GS}	±30	V
Drain Current Pulsed ⁽¹⁾	I _{DM}	12.0	ADC
Continuous Drain Current (T _C =25°C)	I _D	3.0	ADC
Continuous Drain Current (T _C =100°C)	I _D	2.4	ADC
Single Pulsed Avalanche Energy ⁽²⁾	E _{AS}	358	mJ
Maximum Supply Voltage	V _{CC,MAX}	30	V
Analog Input Voltage Range	V _{FB}	-0.3 to V _{SD}	V
Total Power Dissipation	PD	75	W
	Derating	0.6	W/°C
Operating Junction Temperature.	T _J	+150	°C
Operating Ambient Temperature.	T _A	-40 to +85	°C
Storage Temperature Range.	T _{STG}	-55 to +150	°C
KA5H0380R, KA5M0380R, KA5L0380R			
Drain-Gate Voltage (R _{GS} =1MΩ)	V _{DGR}	800	V
Gate-Source (GND) Voltage	V _{GS}	±30	V
Drain Current Pulsed ⁽¹⁾	I _{DM}	12.0	ADC
Continuous Drain Current (T _C =25°C)	I _D	3.0	ADC
Continuous Drain Current (T _C =100°C)	I _D	2.1	ADC
Single Pulsed Avalanche Energy ⁽²⁾	E _{AS}	95	mJ
Maximum Supply Voltage	V _{CC,MAX}	30	V
Analog Input Voltage Range	V _{FB}	-0.3 to V _{SD}	V
Total Power Dissipation	PD	75	W
	Derating	0.6	W/°C
Operating Junction Temperature.	T _J	+150	°C
Operating Ambient Temperature.	T _A	-40 to +85	°C
Storage Temperature Range.	T _{STG}	-55 to +150	°C

Note:

1. Repetitive rating: Pulse width limited by maximum junction temperature
2. L = 51mH, starting T_J = 25°C
3. L = 13μH, starting T_J = 25°C

Electrical Characteristics (SenseFET Part)

(Ta = 25°C unless otherwise specified)

Parameter	Symbol	Condition	Min.	Typ.	Max.	Unit
KA5H0365R, KA5M0365R, KA5L0365R						
Drain-Source Breakdown Voltage	BVDSS	VGS=0V, ID=50μA	650	-	-	V
Zero Gate Voltage Drain Current	IDSS	VDS=Max. Rating, VGS=0V	-	-	50	μA
		VDS=0.8Max. Rating, VGS=0V, TC=125°C	-	-	200	μA
Static Drain-Source on Resistance ^(Note)	RDS(ON)	VGS=10V, ID=0.5A	-	3.6	4.5	Ω
Forward Transconductance ^(Note)	gfs	VDS=50V, ID=0.5A	2.0	-	-	S
Input Capacitance	Ciss	VGS=0V, VDS=25V, f=1MHz	-	720	-	pF
Output Capacitance	Coss		-	40	-	
Reverse Transfer Capacitance	Crss		-	40	-	
Turn On Delay Time	td(on)	VDD=0.5BVDSS, ID=1.0A (MOSFET switching time is essentially independent of operating temperature)	-	150	-	nS
Rise Time	tr		-	100	-	
Turn Off Delay Time	td(off)		-	150	-	
Fall Time	tf		-	42	-	
Total Gate Charge (Gate-Source+Gate-Drain)	Qg	VGS=10V, ID=1.0A, VDS=0.5BVDSS (MOSFET switching time is essentially independent of operating temperature)	-	-	34	nC
Gate-Source Charge	Qgs		-	7.3	-	
Gate-Drain (Miller) Charge	Qgd		-	13.3	-	
KA5H0380R, KA5M0380R, KA5L0380R						
Drain-Source Breakdown Voltage	BVDSS	VGS=0V, ID=50μA	800	-	-	V
Zero Gate Voltage Drain Current	IDSS	VDS=Max. Rating, VGS=0V	-	-	250	μA
		VDS=0.8Max. Rating, VGS=0V, TC=125°C	-	-	1000	μA
Static Drain-Source on Resistance ^(Note)	RDS(ON)	VGS=10V, ID=0.5A	-	4.0	5.0	Ω
Forward Transconductance ^(Note)	gfs	VDS=50V, ID=0.5A	1.5	2.5	-	S
Input Capacitance	Ciss	VGS=0V, VDS=25V, f=1MHz	-	779	-	pF
Output Capacitance	Coss		-	75.6	-	
Reverse Transfer Capacitance	Crss		-	24.9	-	
Turn On Delay Time	td(on)	VDD=0.5BVDSS, ID=1.0A (MOSFET switching time is essentially independent of operating temperature)	-	40	-	nS
Rise Time	tr		-	95	-	
Turn Off Delay Time	td(off)		-	150	-	
Fall Time	tf		-	60	-	
Total Gate Charge (Gate-Source+Gate-Drain)	Qg	VGS=10V, ID=1.0A, VDS=0.5BVDSS (MOSFET switching time is essentially independent of operating temperature)	-	-	34	nC
Gate-Source Charge	Qgs		-	7.2	-	
Gate-Drain (Miller) Charge	Qgd		-	12.1	-	

Note:

1. Pulse test: Pulse width ≤ 300μs, duty ≤ 2%

$$2. S = \frac{1}{R}$$

Electrical Characteristics (Control Part) (Continued)

(Ta = 25°C unless otherwise specified)

Characteristic	Symbol	Test condition	Min.	Typ.	Max.	Unit
UVLO SECTION						
Start Threshold Voltage	VSTART	VFB=GND	14	15	16	V
Stop Threshold Voltage	VSTOP	VFB=GND	8.4	9	9.6	V
OSCILLATOR SECTION						
Initial Accuracy	FOSC	KA5H0365R KA5H0380R	90	100	110	kHz
Initial Accuracy	FOSC	KA5M0365R KA5M0380R	61	67	73	kHz
Initial Accuracy	FOSC	KA5L0365R KA5L0380R	45	50	55	kHz
Frequency Change With Temperature ⁽²⁾	-	-25°C≤Ta≤+85°C	-	±5	±10	%
Maximum Duty Cycle	Dmax	KA5H0365R KA5H0380R	62	67	72	%
Maximum Duty Cycle	Dmax	KA5M0365R KA5M0380R KA5L0365R KA5L0380R	72	77	82	%
FEEDBACK SECTION						
Feedback Source Current	IFB	Ta=25°C, 0V≤Vfb≤3V	0.7	0.9	1.1	mA
Shutdown Feedback Voltage	VSD	Vfb≥6.5V	6.9	7.5	8.1	V
Shutdown Delay Current	Idelay	Ta=25°C, 5V≤Vfb≤VSD	4	5	6	μA
REFERENCE SECTION						
Output Voltage ⁽¹⁾	Vref	Ta=25°C	4.80	5.00	5.20	V
Temperature Stability ⁽¹⁾⁽²⁾	Vref/ΔT	-25°C≤Ta≤+85°C	-	0.3	0.6	mV/°C
CURRENT LIMIT(SELF-PROTECTION)SECTION						
Peak Current Limit	I _{OVER}	Max. inductor current	1.89	2.15	2.41	A
PROTECTION SECTION						
Over Voltage Protection	VOVP	VCC≥24V	25	27	29	V
Thermal Shutdown Temperature (Tj) ⁽¹⁾	TSD	-	140	160	-	°C
TOTAL STANDBY CURRENT SECTION						
Start-up Current	I _{START}	VCC=14V	-	100	170	μA
Operating Supply Current (Control Part Only)	I _{OP}	VCC≤28	-	7	12	mA

Note:

1. These parameters, although guaranteed, are not 100% tested in production
2. These parameters, although guaranteed, are tested in EDS(water test) process

Typical Performance Characteristics(SenseFET part) (KA5H0365R, KA5M0365R, KA5L0365R)

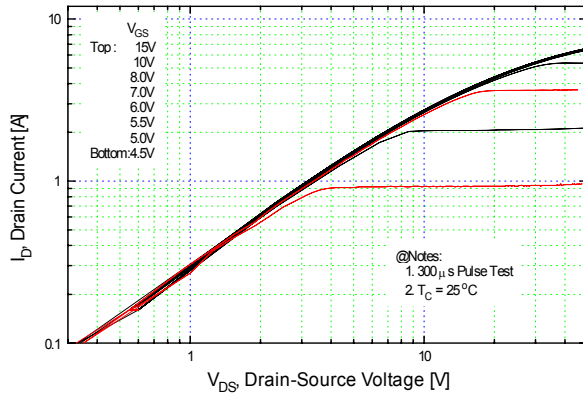

Figure 1. Output Characteristics

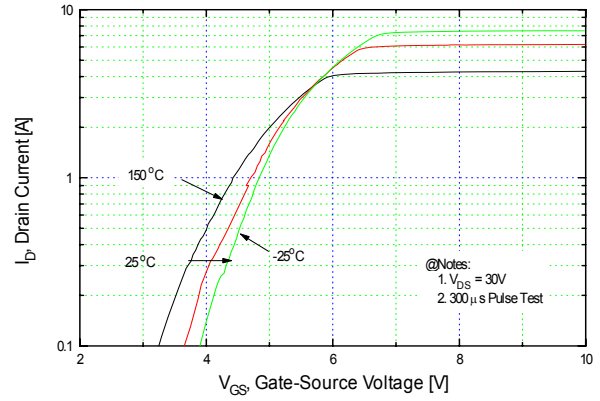

Figure 2. Transfer Characteristics

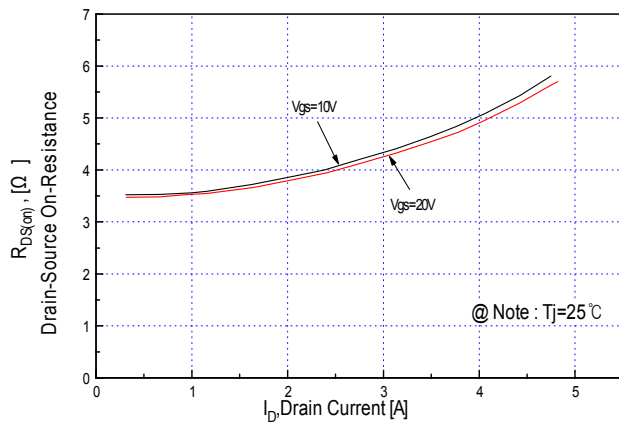

Figure 3. On-Resistance vs. Drain Current

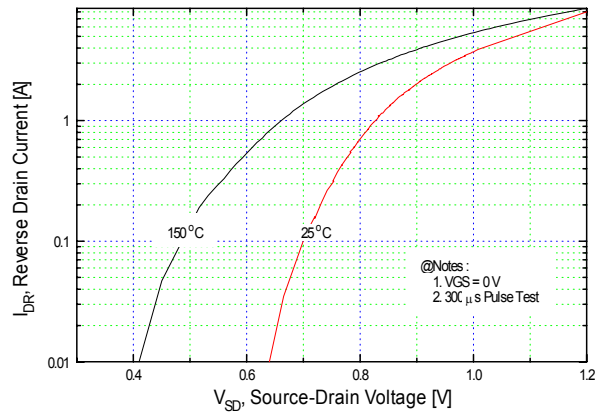

Figure 4. Source-Drain Diode Forward Voltage

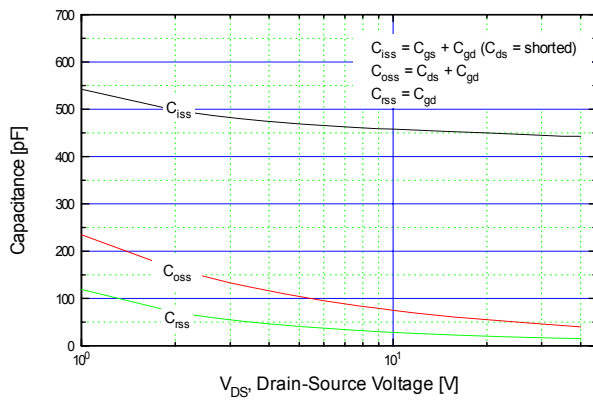

Figure 5. Capacitance vs. Drain-Source Voltage

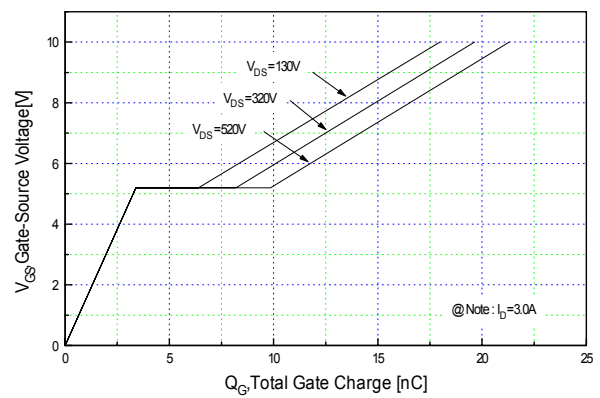

Figure 6. Gate Charge vs. Gate-Source Voltage

Typical Performance Characteristics (Continued)

(KA5H0365R, KA5M0365R, KA5L0365R)

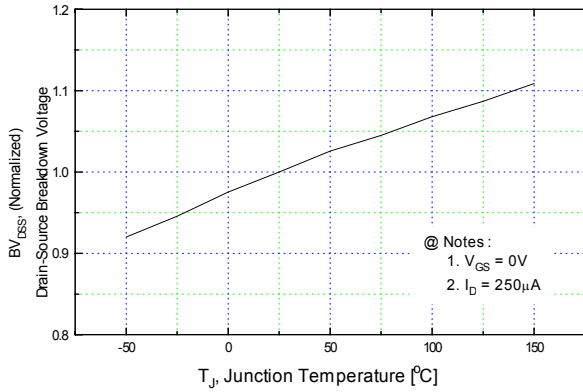

Figure 7. Breakdown Voltage vs. Temperature

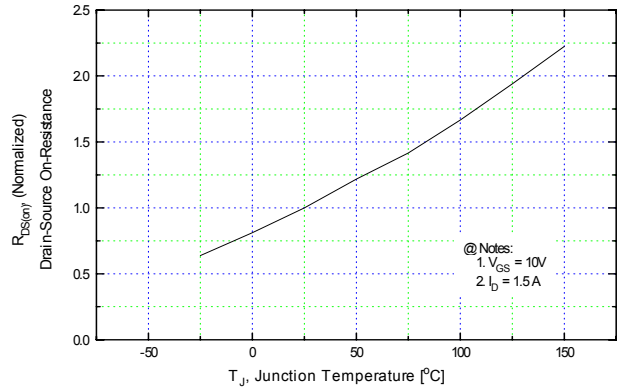

Figure 8. On-Resistance vs. Temperature

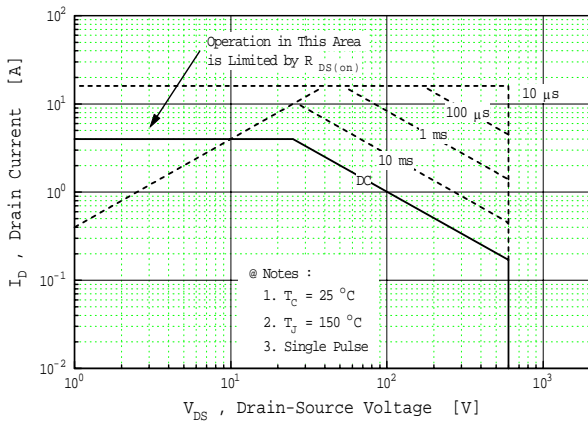

Figure 9. Max. Safe Operating Area

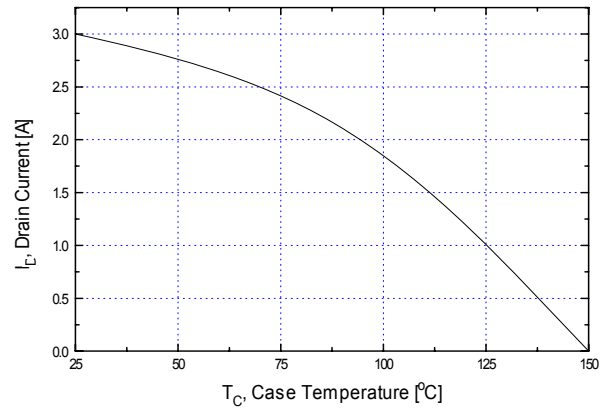

Figure 10. Max. Drain Current vs. Case Temperature

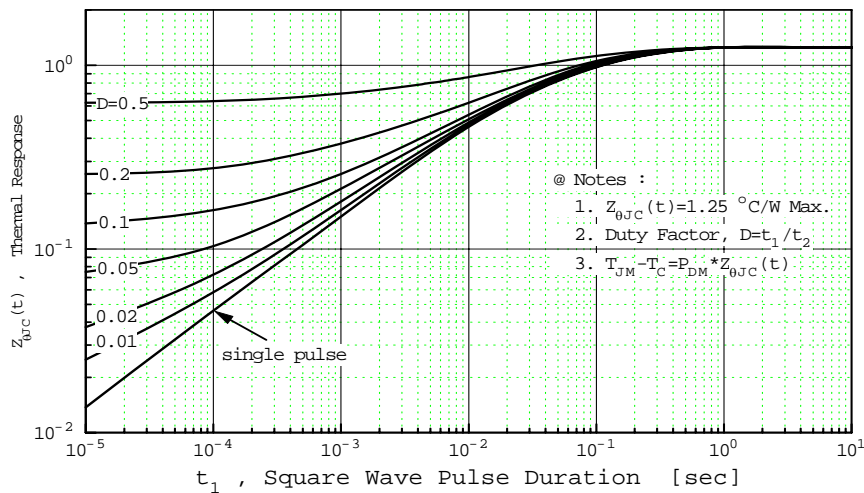

Figure 11. Thermal Response

Typical Performance Characteristics (Continued)

(KA5H0380R, KA5M0380R, KA5L0380R)

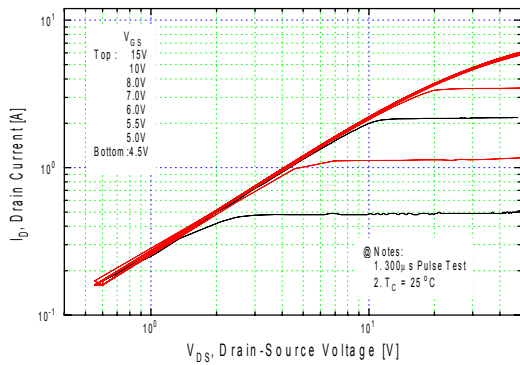

Figure 1. Output Characteristics

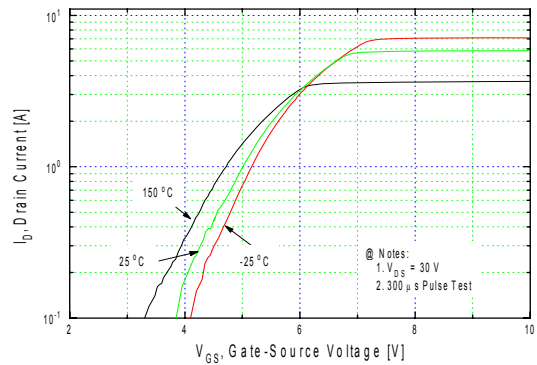

Figure 2. Transfer Characteristics

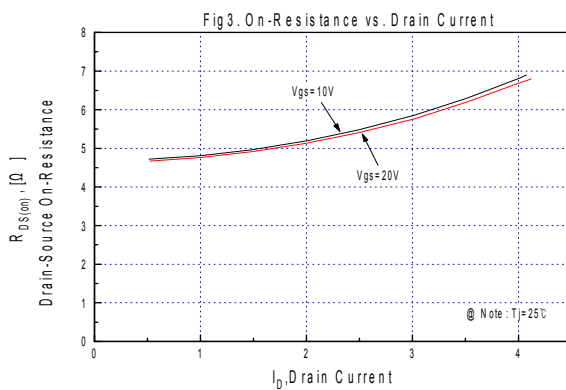

Figure 3. On-Resistance vs. Drain Current

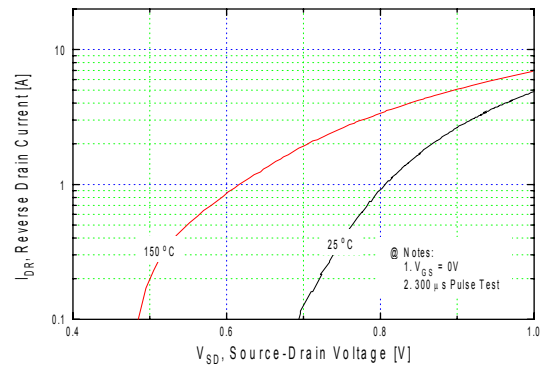

Figure 4. Source-Drain Diode Forward Voltage

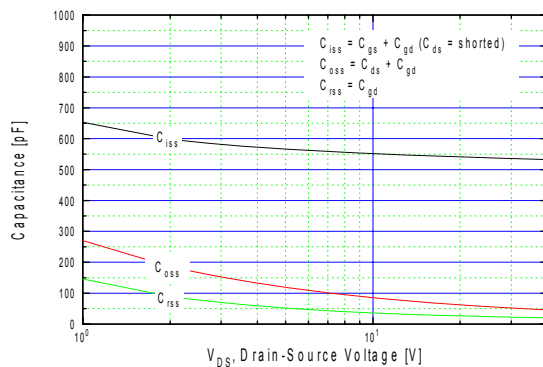

Figure 5. Capacitance vs. Drain-Source Voltage

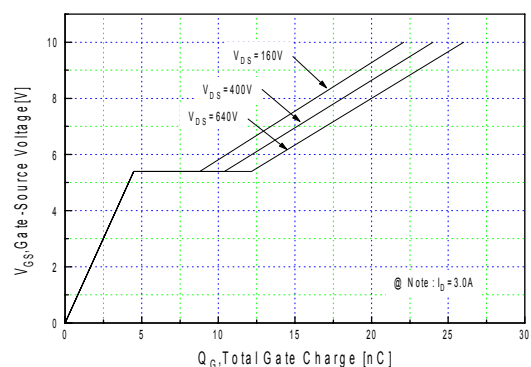

Figure 6. Gate Charge vs. Gate-Source Voltage

Typical Performance Characteristics (Continued)

(KA5H0380R, KA5M0380R, KA5L0380R)

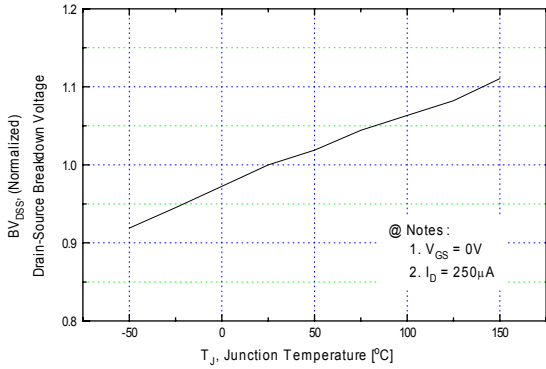

Figure 7. Breakdown Voltage vs. Temperature

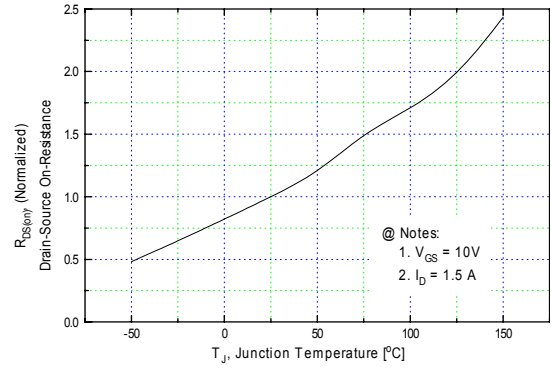

Figure 8. On-Resistance vs. Temperature

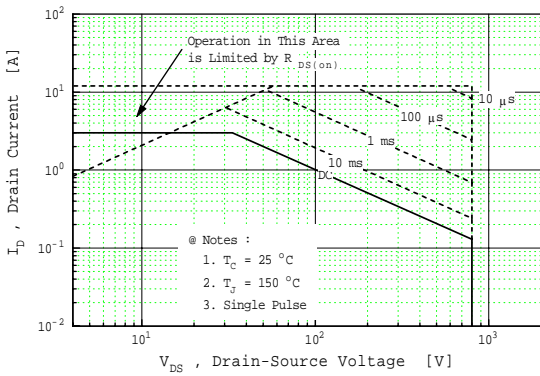

Figure 9. Max. Safe Operating Area

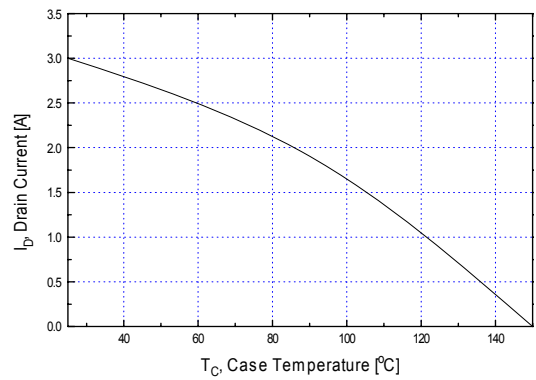

Figure 10. Max. Drain Current vs. Case Temperature

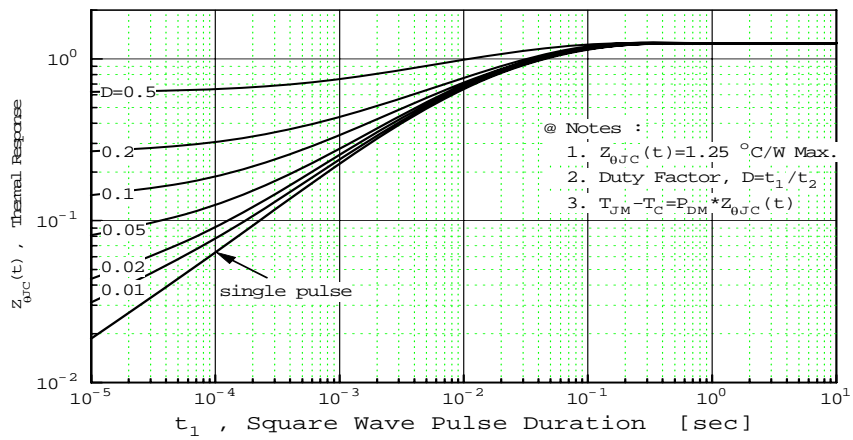

Figure 11. Thermal Response

Typical Performance Characteristics (Control Part) (Continued)

(These characteristic graphs are normalized at $T_a = 25^\circ\text{C}$)

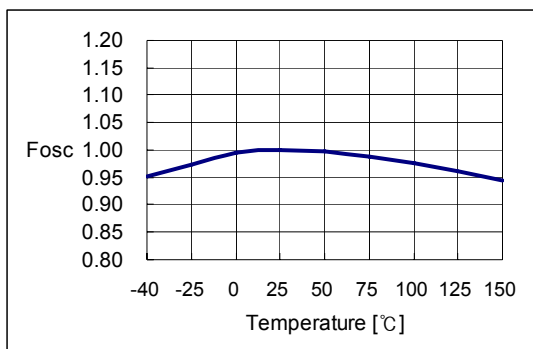

Figure 1. Operating Frequency

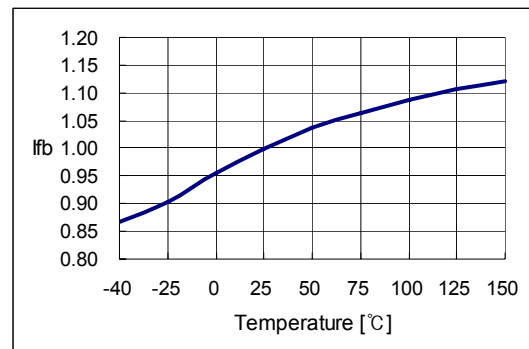

Figure 2. Feedback Source Current

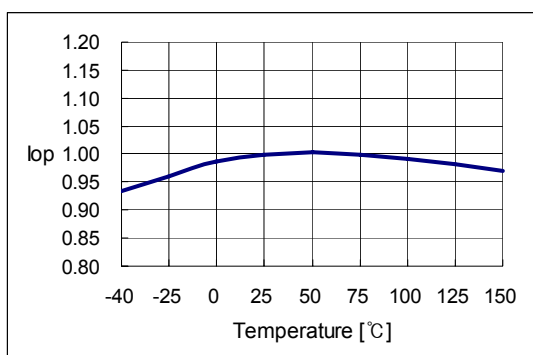

Figure 3. Operating Supply Current

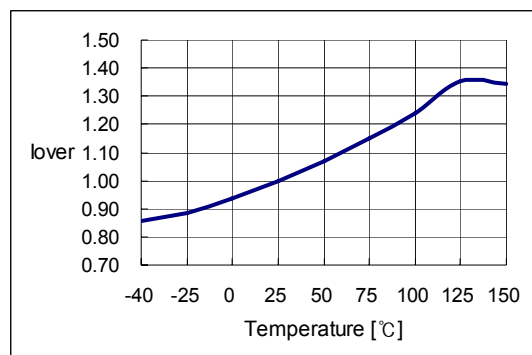

Figure 4. Peak Current Limit

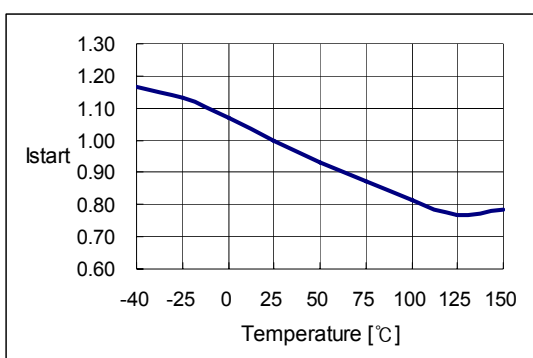

Figure 5. Start up Current

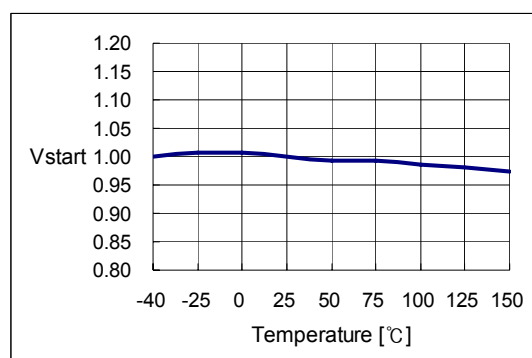

Figure 6. Start Threshold Voltage

Typical Performance Characteristics (Continued)

(These characteristic graphs are normalized at $T_a = 25^\circ\text{C}$)

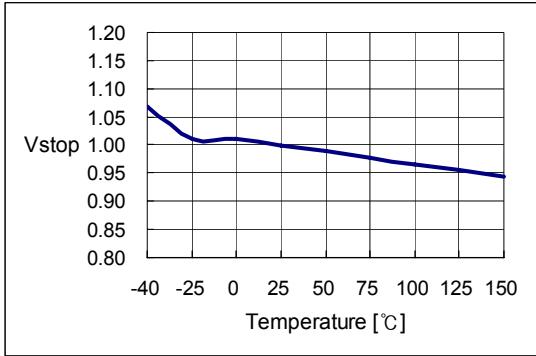

Figure 7. Stop Threshold Voltage

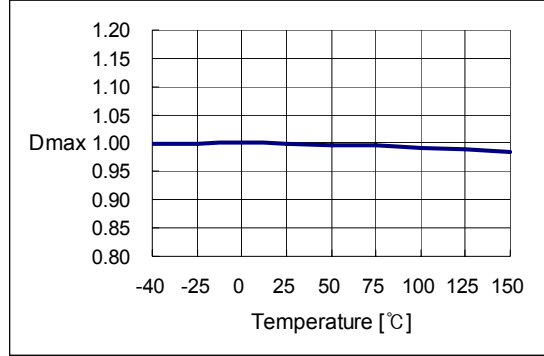

Figure 8. Maximum Duty Cycle

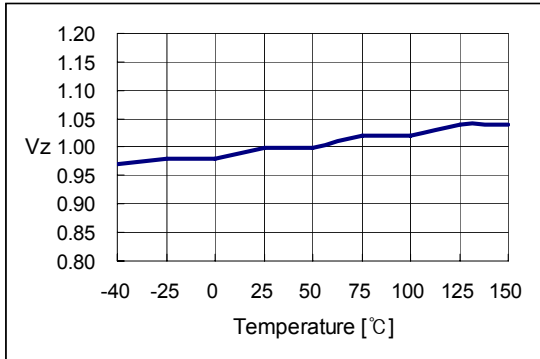

Figure 9. VCC Zener Voltage

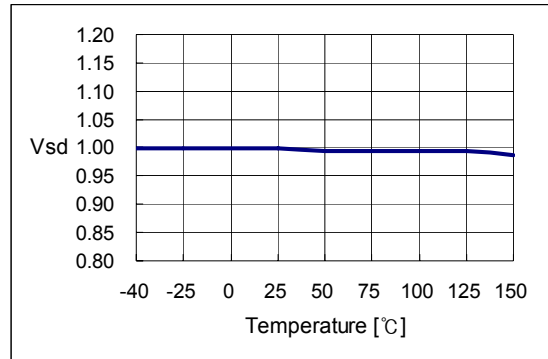

Figure 10. Shutdown Feedback Voltage

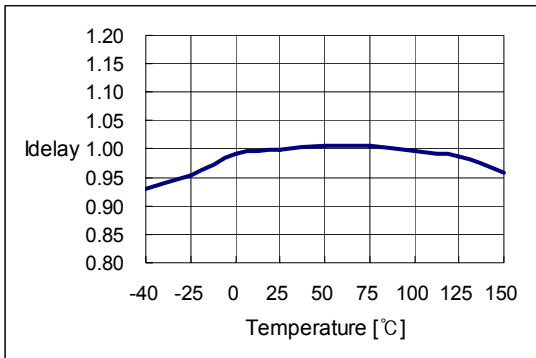

Figure 11. Shutdown Delay Current

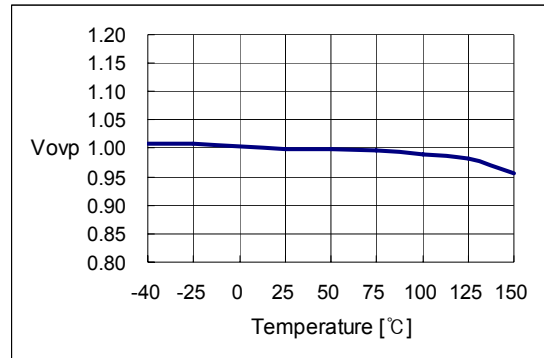

Figure 12. Over Voltage Protection

Typical Performance Characteristics (Continued)

(These characteristic graphs are normalized at $T_a = 25^\circ\text{C}$)

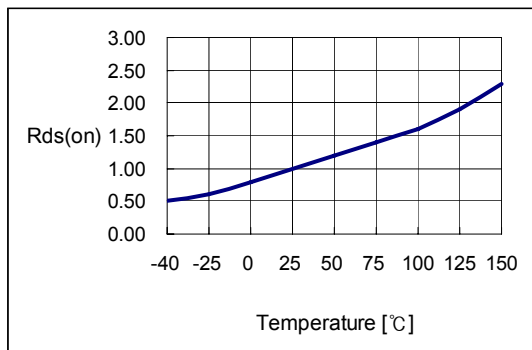

Figure13. Static Drain-Source on Resistance

Ordering Information

Product Number	Package	Marking Code	BVDSS	FOSC	RDS(on)
KA5H0365RTU	TO-220F-4L	5H0365R	650V	100kHz	3.6Ω
KA5H0365RYDTU	TO-220F-4L(Forming)				
KA5M0365RTU	TO-220F-4L	5M0365R	650V	67kHz	3.6Ω
KA5M0365RYDTU	TO-220F-4L(Forming)				
KA5L0365RTU	TO-220F-4L	5L0365R	650V	50kHz	3.6Ω
KA5L0365RYDTU	TO-220F-4L(Forming)				
Product Number	Package	Marking Code	BVDSS	FOSC	RDS(on)
KA5H0380RTU	TO-220F-4L	5H0380R	800V	100kHz	4.6Ω
KA5H0380RYDTU	TO-220F-4L(Forming)				
KA5M0380RTU	TO-220F-4L	5M0380R	800V	67kHz	4.6Ω
KA5M0380RYDTU	TO-220F-4L(Forming)				
KA5L0380RTU	TO-220F-4L	5L0380R	800V	50kHz	4.6Ω
KA5L0380RYDTU	TO-220F-4L(Forming)				

TU :Non Forming Type

YDTU : Forming type

DISCLAIMER

FAIRCHILD SEMICONDUCTOR RESERVES THE RIGHT TO MAKE CHANGES WITHOUT FURTHER NOTICE TO ANY PRODUCTS HEREIN TO IMPROVE RELIABILITY, FUNCTION OR DESIGN. FAIRCHILD DOES NOT ASSUME ANY LIABILITY ARISING OUT OF THE APPLICATION OR USE OF ANY PRODUCT OR CIRCUIT DESCRIBED HEREIN; NEITHER DOES IT CONVEY ANY LICENSE UNDER ITS PATENT RIGHTS, NOR THE RIGHTS OF OTHERS.

LIFE SUPPORT POLICY





FAIRCHILD'S PRODUCTS ARE NOT AUTHORIZED FOR USE AS CRITICAL COMPONENTS IN LIFE SUPPORT DEVICES OR SYSTEMS WITHOUT THE EXPRESS WRITTEN APPROVAL OF THE PRESIDENT OF FAIRCHILD SEMICONDUCTOR CORPORATION. As used herein:

1. Life support devices or systems are devices or systems which, (a) are intended for surgical implant into the body, or (b) support or sustain life, and (c) whose failure to perform when properly used in accordance with instructions for use provided in the labeling, can be reasonably expected to result in a significant injury of the user.
2. A critical component in any component of a life support device or system whose failure to perform can be reasonably expected to cause the failure of the life support device or system, or to affect its safety or effectiveness.



TRADEMARKS

The following includes registered and unregistered trademarks and service marks, owned by Fairchild Semiconductor and/or its global subsidiaries, and is not intended to be an exhaustive list of all such trademarks.

- | | | | |
|---|--|--|---|
| 2Cool™ | FPS™ | PDP SPM™ | The Power Franchise® |
| AccuPower™ | F-PFS™ | Power-SPM™ | the power™ |
| Auto-SPM™ | FRFET® | PowerTrench® | franchise |
| AX-CAP™* | Global Power Resource™ | PowerXS™ | TinyBoost™ |
| BitSiC® | Green FPS™ | Programmable Active Droop™ | TinyBuck™ |
| Build it Now™ | Green FPS™ e-Series™ | QFET® | TinyCalc™ |
| CorePLUS™ | Gmax™ | QS™ | TinyLogic® |
| CorePOWER™ | GTO™ | Quiet Series™ | TINYOPTO™ |
| CROSSVOL™ | IntelliMAX™ | RapidConfigure™ | TinyPower™ |
| CTL™ | ISOPLANAR™ |  ™ | TinyPWM™ |
| Current Transfer Logic™ | Making Small Speakers Sound Louder and Better™ | Saving our world, 1mW/W/kW at a time™ | TinyWire™ |
| DEUXPEED® | MegaBuck™ | SignalWise™ | TranSiC® |
| Dual Cool™ | MICROCOUPLER™ | SmartMax™ | TriFault Detect™ |
| EcoSPARK® | MicroFET™ | SMART START™ | TRUECURRENT®* |
| EfficientMax™ | MicroPak™ | SPM® | µSerDes™ |
| ESBC™ | MicroPak2™ | STEALTH™ |  ™ |
|  ™ | MillerDrive™ | SuperFET® | UHC® |
| Fairchild® | MotionMax™ | SuperSOT™-3 | Ultra FRFET™ |
| Fairchild Semiconductor® | Motion-SPM™ | SuperSOT™-6 | UniFET™ |
| FACT Quiet Series™ | mWSaver™ | SuperSOT™-8 | VCX™ |
| FACT® | OptoHiT™ | SupreMOS® | VisualMax™ |
| FAST® | OPTOLOGIC® | SyncFET™ | VoltagePlus™ |
| FastvCore™ | OPTOPLANAR® | Sync-Lock™ | XS™ |
| FETBench™ | |  SYSTEM GENERAL®* | |
| FlashWriter®* | | | |

* Trademarks of System General Corporation, used under license by Fairchild Semiconductor.

DISCLAIMER

FAIRCHILD SEMICONDUCTOR RESERVES THE RIGHT TO MAKE CHANGES WITHOUT FURTHER NOTICE TO ANY PRODUCTS HEREIN TO IMPROVE RELIABILITY, FUNCTION, OR DESIGN. FAIRCHILD DOES NOT ASSUME ANY LIABILITY ARISING OUT OF THE APPLICATION OR USE OF ANY PRODUCT OR CIRCUIT DESCRIBED HEREIN; NEITHER DOES IT CONVEY ANY LICENSE UNDER ITS PATENT RIGHTS, NOR THE RIGHTS OF OTHERS. THESE SPECIFICATIONS DO NOT EXPAND THE TERMS OF FAIRCHILD'S WORLDWIDE TERMS AND CONDITIONS, SPECIFICALLY THE WARRANTY THEREIN, WHICH COVERS THESE PRODUCTS.

LIFE SUPPORT POLICY

FAIRCHILD'S PRODUCTS ARE NOT AUTHORIZED FOR USE AS CRITICAL COMPONENTS IN LIFE SUPPORT DEVICES OR SYSTEMS WITHOUT THE EXPRESS WRITTEN APPROVAL OF FAIRCHILD SEMICONDUCTOR CORPORATION.

As used herein:

- Life support devices or systems are devices or systems which, (a) are intended for surgical implant into the body or (b) support or sustain life, and (c) whose failure to perform when properly used in accordance with instructions for use provided in the labeling, can be reasonably expected to result in a significant injury of the user.
- A critical component in any component of a life support, device, or system whose failure to perform can be reasonably expected to cause the failure of the life support device or system, or to affect its safety or effectiveness.

ANTI-COUNTERFEITING POLICY

Fairchild Semiconductor Corporation's Anti-Counterfeiting Policy. Fairchild's Anti-Counterfeiting Policy is also stated on our external website, www.fairchildsemi.com, under Sales Support.

Counterfeiting of semiconductor parts is a growing problem in the industry. All manufacturers of semiconductor products are experiencing counterfeiting of their parts. Customers who inadvertently purchase counterfeit parts experience many problems such as loss of brand reputation, substandard performance, failed applications, and increased cost of production and manufacturing delays. Fairchild is taking strong measures to protect ourselves and our customers from the proliferation of counterfeit parts. Fairchild strongly encourages customers to purchase Fairchild parts either directly from Fairchild or from Authorized Fairchild Distributors who are listed by country on our web page cited above. Products customers buy either from Fairchild directly or from Authorized Fairchild Distributors are genuine parts, have full traceability, meet Fairchild's quality standards for handling and storage and provide access to Fairchild's full range of up-to-date technical and product information. Fairchild and our Authorized Distributors will stand behind all warranties and will appropriately address any warranty issues that may arise. Fairchild will not provide any warranty coverage or other assistance for parts bought from Unauthorized Sources. Fairchild is committed to combat this global problem and encourage our customers to do their part in stopping this practice by buying direct or from authorized distributors.

PRODUCT STATUS DEFINITIONS

Definition of Terms

Datasheet Identification	Product Status	Definition
Advance Information	Formative / In Design	Datasheet contains the design specifications for product development. Specifications may change in any manner without notice.
Preliminary	First Production	Datasheet contains preliminary data; supplementary data will be published at a later date. Fairchild Semiconductor reserves the right to make changes at any time without notice to improve design.
No Identification Needed	Full Production	Datasheet contains final specifications. Fairchild Semiconductor reserves the right to make changes at any time without notice to improve the design.
Obsolete	Not In Production	Datasheet contains specifications on a product that is discontinued by Fairchild Semiconductor. The datasheet is for reference information only.

ON Semiconductor and  are trademarks of Semiconductor Components Industries, LLC dba ON Semiconductor or its subsidiaries in the United States and/or other countries. ON Semiconductor owns the rights to a number of patents, trademarks, copyrights, trade secrets, and other intellectual property. A listing of ON Semiconductor's product/patent coverage may be accessed at www.onsemi.com/site/pdf/Patent-Marking.pdf. ON Semiconductor reserves the right to make changes without further notice to any products herein. ON Semiconductor makes no warranty, representation or guarantee regarding the suitability of its products for any particular purpose, nor does ON Semiconductor assume any liability arising out of the application or use of any product or circuit, and specifically disclaims any and all liability, including without limitation special, consequential or incidental damages. Buyer is responsible for its products and applications using ON Semiconductor products, including compliance with all laws, regulations and safety requirements or standards, regardless of any support or applications information provided by ON Semiconductor. "Typical" parameters which may be provided in ON Semiconductor data sheets and/or specifications can and do vary in different applications and actual performance may vary over time. All operating parameters, including "Typicals" must be validated for each customer application by customer's technical experts. ON Semiconductor does not convey any license under its patent rights nor the rights of others. ON Semiconductor products are not designed, intended, or authorized for use as a critical component in life support systems or any FDA Class 3 medical devices or medical devices with a same or similar classification in a foreign jurisdiction or any devices intended for implantation in the human body. Should Buyer purchase or use ON Semiconductor products for any such unintended or unauthorized application, Buyer shall indemnify and hold ON Semiconductor and its officers, employees, subsidiaries, affiliates, and distributors harmless against all claims, costs, damages, and expenses, and reasonable attorney fees arising out of, directly or indirectly, any claim of personal injury or death associated with such unintended or unauthorized use, even if such claim alleges that ON Semiconductor was negligent regarding the design or manufacture of the part. ON Semiconductor is an Equal Opportunity/Affirmative Action Employer. This literature is subject to all applicable copyright laws and is not for resale in any manner.

PUBLICATION ORDERING INFORMATION

LITERATURE FULFILLMENT:

Literature Distribution Center for ON Semiconductor
19521 E. 32nd Pkwy, Aurora, Colorado 80011 USA
Phone: 303-675-2175 or 800-344-3860 Toll Free USA/Canada
Fax: 303-675-2176 or 800-344-3867 Toll Free USA/Canada
Email: orderlit@onsemi.com

N. American Technical Support: 800-282-9855 Toll Free
USA/Canada
Europe, Middle East and Africa Technical Support:
Phone: 421 33 790 2910
Japan Customer Focus Center
Phone: 81-3-5817-1050

ON Semiconductor Website: www.onsemi.com
Order Literature: <http://www.onsemi.com/orderlit>
For additional information, please contact your local
Sales Representative

Looking for pricing, stock, or lifecycle information?

Click below to explore more details on WIN SOURCE:

-  [View KA5H0380RTU on WIN SOURCE](#)
-  [Fairchild/ON Semiconductor Information](#)

Optimize Your Supply Chain with WIN SOURCE Solutions

-  Global Sourcing Solution
-  Obsolete Management
-  Cost Control Management
-  Shortage Management
-  Alternative Solution
-  Excess Inventory Management