

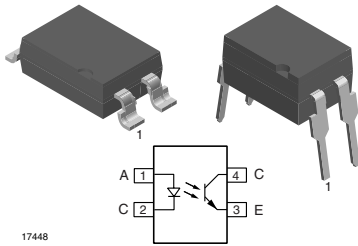

**THE DATASHEET OF  
TPS62850240QDRLRQ1**



# Optocoupler, Phototransistor Output, High Reliability, 5300 V<sub>RMS</sub>



## DESCRIPTION

The SFH615A (DIP) and SFH6156 (SMD) feature a variety of transfer ratios, low coupling capacitance and high isolation voltage. These couplers have a GaAs infrared diode emitter, which is optically coupled to a silicon planar phototransistor detector, and is incorporated in a plastic DIP-4 or SMD package.

The coupling devices are designed for signal transmission between two electrically separated circuits.

The couplers are end-stackable with 2.54 mm lead spacing. Creepage and clearance distances of > 8 mm are achieved with option 6. This version complies with IEC 60950 (DIN VDE 0805) for reinforced insulation up to an operation voltage of 400 V<sub>RMS</sub> or DC. Specifications subject to change.

## FEATURES

- Excellent CTR linearity depending on forward current
- Isolation test voltage, 5300 V<sub>RMS</sub>
- Fast switching times
- Low CTR degradation
- Low coupling capacitance
- Compliant to RoHS directive 2002/95/EC and in accordance to WEEE 2002/96/EC

**RoHS**  
COMPLIANT

## APPLICATIONS

- Switchmode power supply
- Telecom
- Battery powered equipment

## AGENCY APPROVALS

- UL1577, file no. E52744 system code H or J, double protection
- DIN EN 60747-5-5 (VDE 0884) available with option 1

## ORDER INFORMATION

PART	REMARKS
SFH615A-1	CTR 40 % to 80 %, DIP-4
SFH615A-2	CTR 63 % to 125 %, DIP-4
SFH615A-3	CTR 100 % to 200 %, DIP-4
SFH615A-4	CTR 160 % to 320 %, DIP-4
SFH6156-1	CTR 40 % to 80 %, SMD-4
SFH6156-2	CTR 63 % to 125 %, SMD-4
SFH6156-3	CTR 100 % to 200 %, SMD-4
SFH6156-4	CTR 160 % to 320 %, SMD-4
SFH615A-1X006	CTR 40 % to 80 %, DIP-4 400 mil (option 6)
SFH615A-1X007	CTR 40 % to 80 %, SMD-4 (option 7)
SFH615A-2X006	CTR 63 % to 125 %, DIP-4 400 mil (option 6)
SFH615A-2X007	CTR 63 % to 125 %, SMD-4 (option 7)
SFH615A-2X009	CTR 63 % to 125 %, SMD-4 (option 9)
SFH615A-3X006	CTR 100 % to 200 %, DIP-4 400 mil (option 6)
SFH615A-3X007	CTR 100 % to 200 %, SMD-4 (option 7)
SFH615A-3X008	CTR 100 % to 200 %, SMD-4 (option 8)
SFH615A-3X009	CTR 100 % to 200 %, SMD-4 (option 9)
SFH615A-4X006	CTR 160 % to 320 %, DIP-4 400 mil (option 6)
SFH615A-4X007	CTR 160 % to 320 %, SMD-4 (option 7)
SFH615A-4X008	CTR 160 % to 320 %, SMD-4 (option 8)
SFH615A-4X009	CTR 160 % to 320 %, SMD-4 (option 9)

### Note

For additional information on the available options refer to option information. See tape and reel section for 4 pin optocouplers T0 with 90° rotation.

ABSOLUTE MAXIMUM RATINGS (1)				
PARAMETER	TEST CONDITION	SYMBOL	VALUE	UNIT
<b>INPUT</b>				
Reverse voltage		V <sub>R</sub>	6	V
DC forward current		I <sub>F</sub>	60	mA
Surge forward current	t <sub>p</sub> ≤ 10 μs	I <sub>FSM</sub>	2.5	A
<b>OUTPUT</b>				
Collector emitter voltage		V <sub>CE</sub>	70	V
Emitter collector voltage		V <sub>ECO</sub>	7	V
Collector current		I <sub>C</sub>	50	mA
	t <sub>p</sub> ≤ 1 ms	I <sub>C</sub>	100	mA
<b>COUPLER</b>				
Isolation test voltage between emitter and detector	t = 1 s	V <sub>ISO</sub>	5300	V <sub>RMS</sub>
Creepage distance			≥ 7	mm
Clearance distance			≥ 7	mm
Insulation thickness between emitter and detector			≥ 0.4	mm
Comparative tracking index per DIN IEC112/VDE 0303 part 1		CTI	≥ 175	
Isolation resistance	V <sub>IO</sub> = 500 V, T <sub>amb</sub> = 25 °C	R <sub>IO</sub>	≥ 10 <sup>12</sup>	Ω
	V <sub>IO</sub> = 500 V, T <sub>amb</sub> = 100 °C	R <sub>IO</sub>	≥ 10 <sup>11</sup>	Ω
Storage temperature range		T <sub>stg</sub>	- 55 to + 150	°C
Ambient temperature range		T <sub>amb</sub>	- 55 to +100	°C
Soldering temperature (2)	max. 10 s, dip soldering distance to seating plane ≥ 1.5 mm	T <sub>slid</sub>	260	°C

### Notes

(1) T<sub>amb</sub> = 25 °C, unless otherwise specified.

Stresses in excess of the absolute maximum ratings can cause permanent damage to the device. Functional operation of the device is not implied at these or any other conditions in excess of those given in the operational sections of this document. Exposure to absolute maximum ratings for extended periods of the time can adversely affect reliability.

(2) Refer to reflow profile for soldering conditions for surface mounted devices (SMD). Refer to wave profile for soldering conditions for through hole devices (DIP).

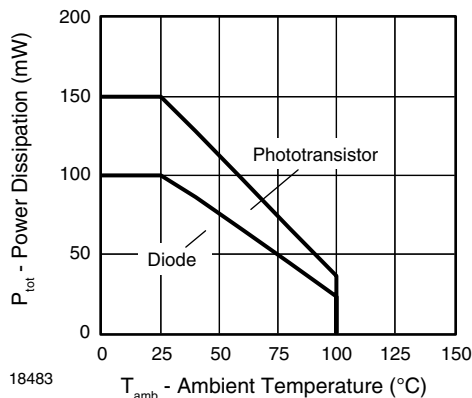

Fig. 1 - Permissible Power Dissipation vs. Ambient Temperature

THERMAL CHARACTERISTICS			
PARAMETER	SYMBOL	VALUE	UNIT
LED power dissipation	$P_{diss}$	100	mW
Output power dissipation	$P_{diss}$	150	mW
Maximum LED junction temperature	$T_{jmax.}$	125	°C
Maximum output die junction temperature	$T_{jmax.}$	125	°C
Thermal resistance, junction emitter to board	$\theta_{EB}$	173	°C/W
Thermal resistance, junction emitter to case	$\theta_{EC}$	149	°C/W
Thermal resistance, junction detector to board	$\theta_{DB}$	111	°C/W
Thermal resistance, junction detector to case	$\theta_{DC}$	127	°C/W
Thermal resistance, junction emitter to junction detector	$\theta_{ED}$	95	°C/W
Thermal resistance, board to ambient <sup>(2)</sup>	$\theta_{BA}$	195	°C/W
Thermal resistance, case to ambient <sup>(2)</sup>	$\theta_{CA}$	3573	°C/W

**Notes**

- (1) The thermal model is represented in the thermal network below. Each resistance value given in this model can be used to calculate the temperatures at each node for a given operating condition. The thermal resistance from board to ambient will be dependent on the type of PCB, layout and thickness of copper traces. For a detailed explanation of the thermal model, please reference Vishay's thermal characteristics of optocouplers application note.
- (2) For 2 layer FR4 board (4" x 3" x 0.062")

ELECTRICAL CHARACTERISTICS							
PARAMETER	TEST CONDITION	PART	SYMBOL	MIN.	TYP.	MAX.	UNIT
<b>INPUT</b>							
Forward voltage	$I_F = 60 \text{ mA}$		$V_F$		1.25	1.65	V
Reverse current	$V_R = 6 \text{ V}$		$I_R$		0.01	10	$\mu\text{A}$
Capacitance	$V_R = 0 \text{ V}, f = 1 \text{ MHz}$		$C_O$		13		pF
<b>OUTPUT</b>							
Collector emitter capacitance	$V_{CE} = 5 \text{ V}, f = 1 \text{ MHz}$		$C_{CE}$		5.2		pF
Collector emitter leakage current	$V_{CE} = 10 \text{ V}$	SFH615A-1	$I_{CEO}$		2	50	nA
		SFH6156-1	$I_{CEO}$		2	50	nA
		SFH615A-2	$I_{CEO}$		2	50	nA
		SFH6156-2	$I_{CEO}$		2	50	nA
		SFH615A-3	$I_{CEO}$		5	100	nA
		SFH6156-3	$I_{CEO}$		5	100	nA
		SFH615A-4	$I_{CEO}$		5	100	nA
		SFH6156-4	$I_{CEO}$		5	100	nA
<b>COUPLER</b>							
Collector emitter saturation voltage	$I_F = 10 \text{ mA}, I_C = 2.5 \text{ mA}$		$V_{CEsat}$		0.25	0.4	V
Coupling capacitance			$C_C$		0.4		pF

**Note**

$T_{amb} = 25 \text{ °C}$ , unless otherwise specified.

Minimum and maximum values are testing requirements. Typical values are characteristics of the device and are the result of engineering evaluation. Typical values are for information only and are not part of the testing requirements.

CURRENT TRANSFER RATIO							
PARAMETER	TEST CONDITION	PART	SYMBOL	MIN.	TYP.	MAX.	UNIT
I <sub>C</sub> /I <sub>F</sub>	I <sub>F</sub> = 10 mA, V <sub>CE</sub> = 5 V	SFH615A-1	CTR	40		80	%
		SFH6156-1	CTR	40		80	%
		SFH615A-2	CTR	63		125	%
		SFH6156-2	CTR	63		125	%
		SFH615A-3	CTR	100		200	%
		SFH6156-3	CTR	100		200	%
		SFH615A-4	CTR	160		320	%
		SFH6156-4	CTR	160		320	%
	I <sub>F</sub> = 1 mA, V <sub>CE</sub> = 5 V	SFH615A-1	CTR	13	30		%
		SFH6156-1	CTR	13	30		%
		SFH615A-2	CTR	22	45		%
		SFH6156-2	CTR	22	45		%
		SFH615A-3	CTR	34	70		%
		SFH6156-3	CTR	34	70		%
		SFH615A-4	CTR	56	90		%
		SFH6156-4	CTR	56	90		%

SWITCHING CHARACTERISTICS							
PARAMETER	TEST CONDITION	PART	SYMBOL	MIN.	TYP.	MAX.	UNIT
<b>NON-SATURATED</b>							
Rise time	I <sub>F</sub> = 10 mA, V <sub>CC</sub> = 5 V, T <sub>A</sub> = 25 °C, R <sub>L</sub> = 75 Ω		t <sub>r</sub>		2		μs
Fall time	I <sub>F</sub> = 10 mA, V <sub>CC</sub> = 5 V, T <sub>A</sub> = 25 °C, R <sub>L</sub> = 75 Ω		t <sub>f</sub>		2		μs
Turn-on time	I <sub>F</sub> = 10 mA, V <sub>CC</sub> = 5 V, T <sub>A</sub> = 25 °C, R <sub>L</sub> = 75 Ω		t <sub>on</sub>		3		μs
Turn-off time	I <sub>F</sub> = 10 mA, V <sub>CC</sub> = 5 V, T <sub>A</sub> = 25 °C, R <sub>L</sub> = 75 Ω		t <sub>off</sub>		2.3		μs
Cut-off frequency	I <sub>F</sub> = 10 mA, V <sub>CC</sub> = 5 V, T <sub>A</sub> = 25 °C, R <sub>L</sub> = 75 Ω		f <sub>ctr</sub>		250		kHz
<b>SATURATED</b>							
Rise time	V <sub>CC</sub> = 5 V, T <sub>A</sub> = 25 °C, R <sub>L</sub> = 1 kΩ, I <sub>F</sub> = 20 mA	SFH615A-1	t <sub>r</sub>		2		μs
		SFH6156-1					
	V <sub>CC</sub> = 5 V, T <sub>A</sub> = 25 °C, R <sub>L</sub> = 1 kΩ, I <sub>F</sub> = 10 mA	SFH615A-2	t <sub>r</sub>		3		μs
		SFH6156-2					
		SFH615A-3					
		SFH6156-3					
V <sub>CC</sub> = 5 V, T <sub>A</sub> = 25 °C, R <sub>L</sub> = 1 kΩ, I <sub>F</sub> = 5 mA	SFH615A-4	t <sub>r</sub>		4		μs	
	SFH6156-4						
Fall time	V <sub>CC</sub> = 5 V, T <sub>A</sub> = 25 °C, R <sub>L</sub> = 1 kΩ, I <sub>F</sub> = 20 mA	SFH615A-1	t <sub>f</sub>		11		μs
		SFH6156-1					
	V <sub>CC</sub> = 5 V, T <sub>A</sub> = 25 °C, R <sub>L</sub> = 1 kΩ, I <sub>F</sub> = 10 mA	SFH615A-2	t <sub>f</sub>		14		μs
		SFH6156-2					
		SFH615A-3					
		SFH6156-3					
	V <sub>CC</sub> = 5 V, T <sub>A</sub> = 25 °C, R <sub>L</sub> = 1 kΩ, I <sub>F</sub> = 5 mA	SFH615A-4	t <sub>f</sub>		15		μs
		SFH6156-4					



SWITCHING CHARACTERISTICS							
PARAMETER	TEST CONDITION	PART	SYMBOL	MIN.	TYP.	MAX.	UNIT
<b>SATURATED</b>							
Turn-on time	V <sub>CC</sub> = 5 V, T <sub>A</sub> = 25 °C, R <sub>L</sub> = 1 kΩ, I <sub>F</sub> = 20 mA	SFH615A-1	t <sub>on</sub>		3		μs
		SFH6156-1					
	V <sub>CC</sub> = 5 V, T <sub>A</sub> = 25 °C, R <sub>L</sub> = 1 kΩ, I <sub>F</sub> = 10 mA	SFH615A-2	t <sub>on</sub>		4.2		μs
		SFH6156-2					
		SFH615A-3	t <sub>on</sub>		4.2		μs
		SFH6156-3					
V <sub>CC</sub> = 5 V, T <sub>A</sub> = 25 °C, R <sub>L</sub> = 1 kΩ, I <sub>F</sub> = 5 mA	SFH615A-4	t <sub>on</sub>		6		μs	
	SFH6156-4						
Turn-off time	V <sub>CC</sub> = 5 V, T <sub>A</sub> = 25 °C, R <sub>L</sub> = 1 kΩ, I <sub>F</sub> = 20 mA	SFH615A-1	t <sub>off</sub>		18		μs
		SFH6156-1					
	V <sub>CC</sub> = 5 V, T <sub>A</sub> = 25 °C, R <sub>L</sub> = 1 kΩ, I <sub>F</sub> = 10 mA	SFH615A-2	t <sub>off</sub>		23		μs
		SFH6156-2					
		SFH615A-3	t <sub>off</sub>		23		μs
		SFH6156-3					
V <sub>CC</sub> = 5 V, T <sub>A</sub> = 25 °C, R <sub>L</sub> = 1 kΩ, I <sub>F</sub> = 5 mA	SFH615A-4	t <sub>off</sub>		25		μs	
	SFH6156-4						

SAFETY AND INSULATION RATINGS						
PARAMETER	TEST CONDITION	SYMBOL	MIN.	TYP.	MAX.	UNIT
Climatic classification (according to IEC 68 part 1)				55/100/21		
Comparative tracking index		CTI	175		399	
V <sub>IOTM</sub>			10 000			V
V <sub>IORM</sub>			890			V
P <sub>SO</sub>					400	mW
I <sub>SI</sub>					275	mA
T <sub>SI</sub>					175	°C
Creepage distance	standard DIP-4		7			mm
Clearance distance	standard DIP-4		7			mm
Creepage distance	400 mil DIP-4		8			mm
Clearance distance	400 mil DIP-4		8			mm
Insulation thickness, reinforced rated	per IEC 60950 2.10.5.1		0.4			mm

**Note**

As per IEC 60747-5-2, § 7.4.3.8.1, this optocoupler is suitable for "safe electrical insulation" only within the safety ratings. Compliance with the safety ratings shall be ensured by means of protective circuits.

# SFH615A, SFH6156



Vishay Semiconductors Optocoupler, Phototransistor Output,  
High Reliability, 5300 V<sub>RMS</sub>

## TYPICAL CHARACTERISTICS

T<sub>amb</sub> = 25 °C, unless otherwise specified

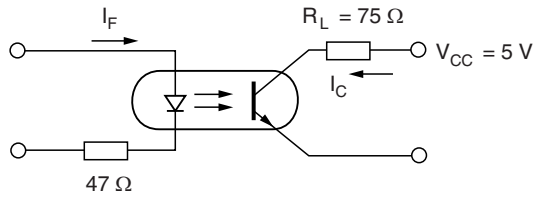

isfh615a\_01

Fig. 2 - Linear Operation (without Saturation)

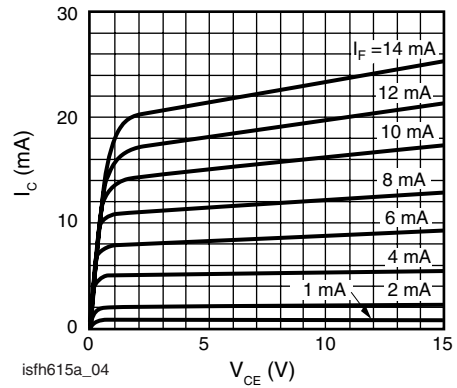

isfh615a\_04

Fig. 5 - Output Characteristics (Typ.) Collector Current vs. Collector Emitter Voltage

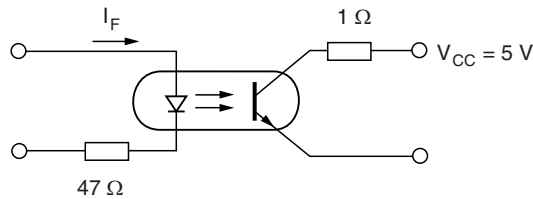

isfh615a\_02

Fig. 3 - Switching Operation (with Saturation)

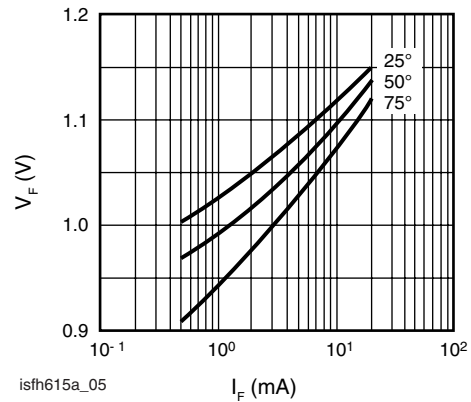

isfh615a\_05

Fig. 6 - Diode Forward Voltage (Typ.) vs. Forward Current

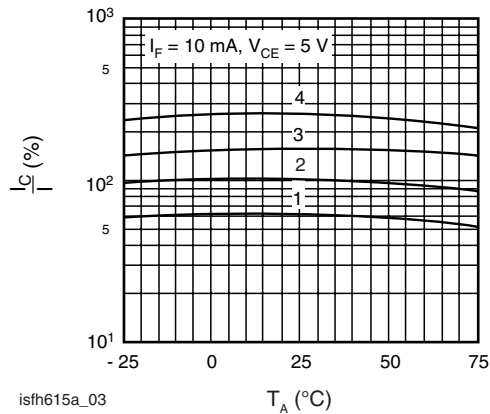

isfh615a\_03

Fig. 4 - Current Transfer Ratio (Typ.) vs. Temperature

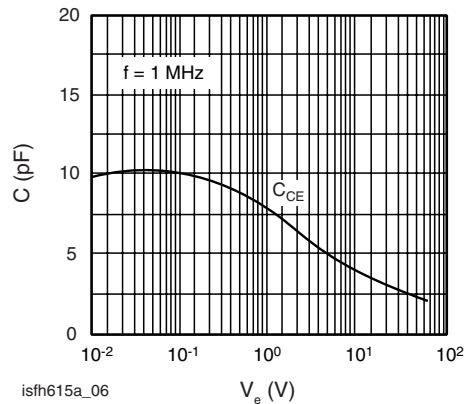

isfh615a\_06

Fig. 7 - Transistor Capacitance (Typ.) vs. Collector Emitter Voltage

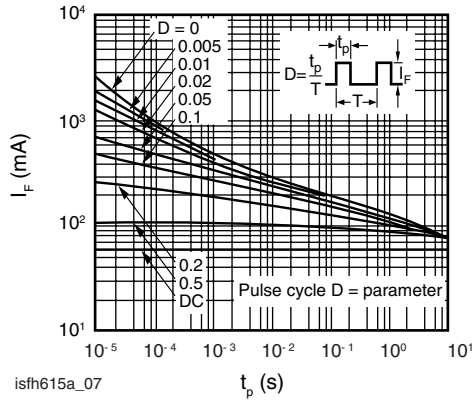
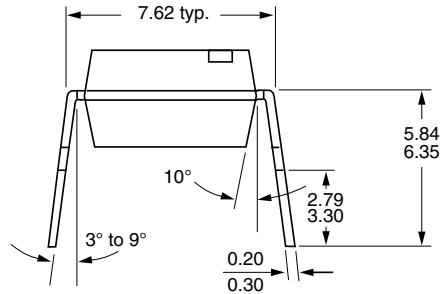
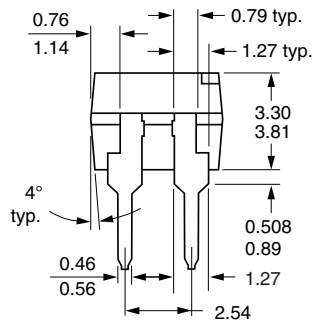
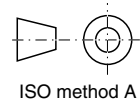
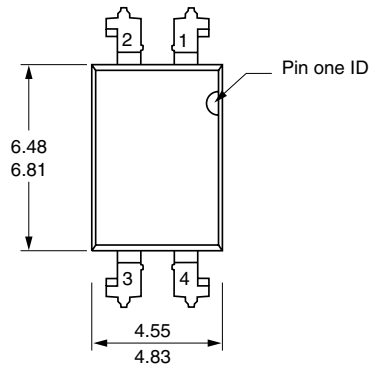

Fig. 8 - Permissible Pulse Handling Capability Forward Current vs. Pulse Width

## PACKAGE DIMENSIONS millimeters



i178027

# SFH615A, SFH6156



Vishay Semiconductors Optocoupler, Phototransistor Output,  
High Reliability, 5300 V<sub>RMS</sub>

## SMD, option 7 (only available on SFH615A products)

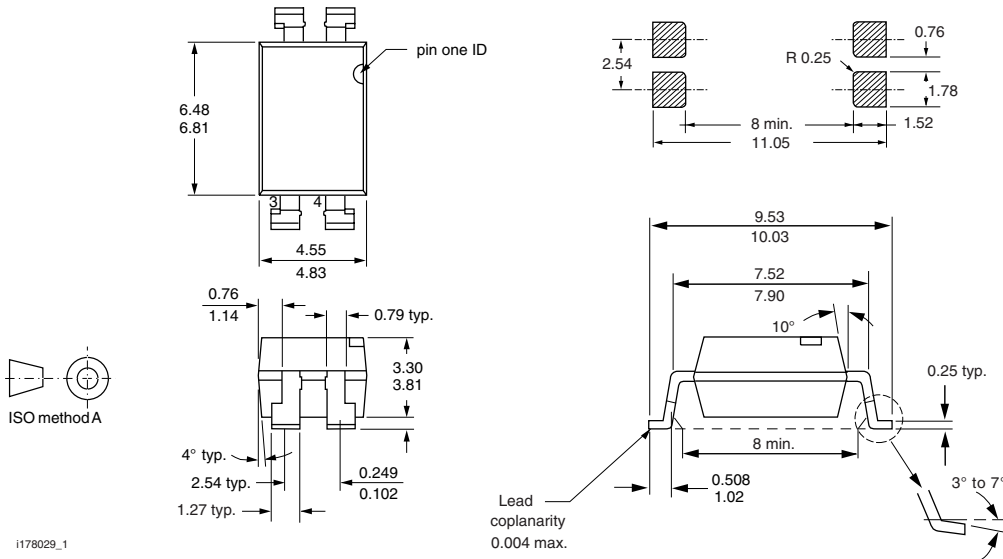

### Option 6

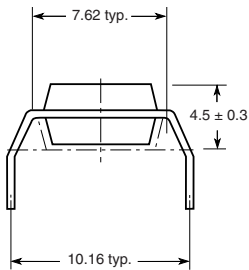

### Option 7

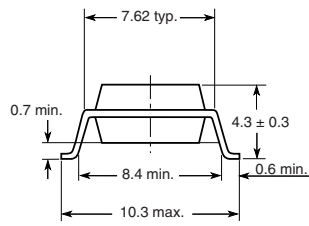

### Option 8

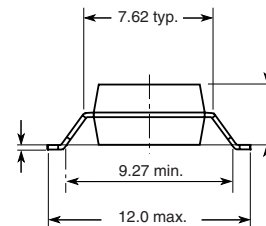

### Option 9 or SFH6156

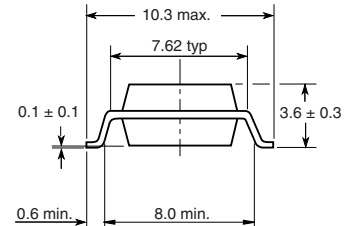

20802-6

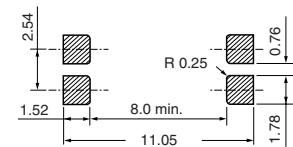
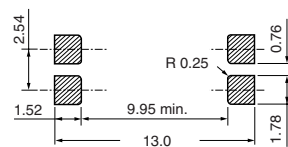
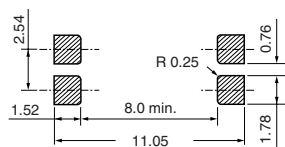

## PACKAGE MARKING

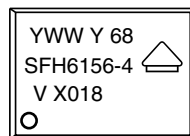

21764-38

This is an example of the marking used on the SFH6156-4X018T



## Disclaimer

All product specifications and data are subject to change without notice.

Vishay Intertechnology, Inc., its affiliates, agents, and employees, and all persons acting on its or their behalf (collectively, "Vishay"), disclaim any and all liability for any errors, inaccuracies or incompleteness contained herein or in any other disclosure relating to any product.

Vishay disclaims any and all liability arising out of the use or application of any product described herein or of any information provided herein to the maximum extent permitted by law. The product specifications do not expand or otherwise modify Vishay's terms and conditions of purchase, including but not limited to the warranty expressed therein, which apply to these products.

No license, express or implied, by estoppel or otherwise, to any intellectual property rights is granted by this document or by any conduct of Vishay.

The products shown herein are not designed for use in medical, life-saving, or life-sustaining applications unless otherwise expressly indicated. Customers using or selling Vishay products not expressly indicated for use in such applications do so entirely at their own risk and agree to fully indemnify Vishay for any damages arising or resulting from such use or sale. Please contact authorized Vishay personnel to obtain written terms and conditions regarding products designed for such applications.

Product names and markings noted herein may be trademarks of their respective owners.

## Looking for pricing, stock, or lifecycle information?

Click below to explore more details on WIN SOURCE:

 [View TPS62850240QDRLRQ1 on WIN SOURCE](#)

 [Texas Instruments](#) Information

## Optimize Your Supply Chain with WIN SOURCE Solutions

-  Global Sourcing Solution
-  Obsolete Management
-  Cost Control Management
-  Shortage Management
-  Alternative Solution
-  Excess Inventory Management