

Product Description

The TGL2767–SM is a packaged wideband voltage-variable attenuator using Qorvo's production 0.15um GaAs pHEMT process (QPHT15). Operating from 2 – 31 GHz, the TGL2767–SM offers 19 dB of attenuation range with < 2 dB insertion loss in the reference state. The TGL2767–SM's broadband performance allows it to be a single solution for several radar and communication bands, as well as electronic warfare, instrumentation and other general RF–based applications.

The TGL2767–SM is fully matched to 50 ohms and offered in a small 3.00 x 3.00 mm surface mount package. This, along with using standard control and reference voltages, allows users to integrate the TGL2767–SM into their system with minimal effort.

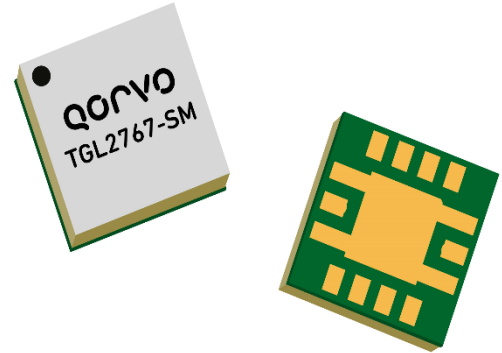

3 x 3 mm Air Cavity Laminate Package

Product Features

- Frequency Range: 2–31 GHz
- Attenuation Range: 19 dB
- Insertion Loss (Ref. State): < 2 dB
- Control Voltage: 0.0 to 1.5 V
- Reference Voltage: 1.5 V
- Package Size: 3.00 x 3.00 x 1.64 mm

Performance is typical across frequency. Please reference the electrical specification table and data plots for more details.

Block Diagram

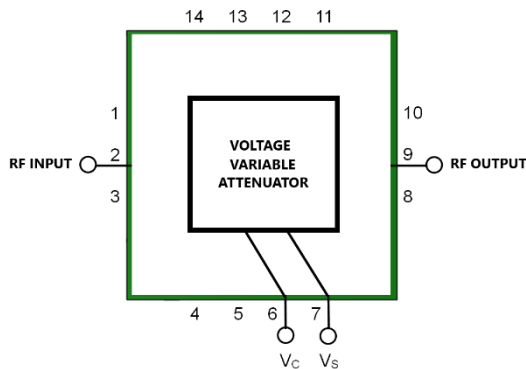

Applications

- Commercial and Military Radar
- Satellite Communications
- Point to Point Radio
- Electronic Warfare
- Instrumentation
- General Purpose

Ordering Information

Part No.	Description
TGL2767-SMTR7	TGL2767-SM 2–31 GHz Voltage Variable Attenuator. 750 Piece 7" Reel
TGL2767-SMSR	100 Piece 7" Reel
TGL2767-SMEVB	Evaluation Board



TGL2767-SM

2 – 31GHz Voltage Variable Attenuator

Absolute Maximum Ratings

Parameter	Value/Range
Control Voltage (V_C , V_S)	± 3.0 V
Control Current (I_C , I_S)	3 mA
Input Power (P_{IN})	30 dBm
Power Dissipation (P_{DISS})	1 W
Mounting Temperature (30 seconds)	260 °C
Operating Channel Temperature	150 °C
Storage Temperature	-55 to 150 °C

Operation of this device outside the parameter ranges given above may cause permanent damage. These are stress ratings only, and functional operation of the device at these conditions is not implied.

Recommended Operating Conditions

Parameter	Value/Range
Control Voltage (V_C); $V_C \leq V_S$	0 – 1.5 V
Reference Voltage ¹ (V_S)	1.5 V
Operating Temperature Range	-40 to +85 °C

Note: ¹ V_S can be adjusted as needed to compensate for the FET threshold variations among wafer/lots.

Electrical specifications are measured at specified test conditions. Specifications are not guaranteed over all recommended operating conditions.

Electrical Specifications

Test conditions, unless otherwise noted: 25 °C, $V_C = 0 - 1.5$ V, $V_S = 1.5$ V; $V_C \leq V_S$

Parameter		Min	Typical	Max	Units
Frequency Range		2	-	31	GHz
Attenuation Range	Freq. = 2 to 25 GHz	17.5	19 ⁽¹⁾	-	dB
	Freq. = 30 to 31 GHz	16.0	18.5 ⁽¹⁾	-	dB
Reference State Insertion Loss ($V_C = 1.5$ V)	Freq. = 2 to 25 GHz	-	1.6	2.0	dB
	Freq. = 30 to 31 GHz	-	2.0	3.8	dB
Input Return Loss		-	12	8	dB
Output Return Loss		-	12	8	dB
IIP3 (10 MHz tone spacing, $P_{IN}/Tone = 10$ dBm)	V_C set for 0 dB	-	>38	-	dBm
	V_C set for 5 dB	-	>25	-	dBm
	V_C set for 10 dB	-	>22	-	dBm
	V_C set for 15 dB	-	>22	-	dBm
	V_C set for 19 dB	-	>30	-	dBm

(1) Maximum attenuation of 20dB can be achieved with V_C at -1.5V.

Performance Plots – Small Signal

Test conditions unless otherwise noted: Temp. = 25 °C, $V_S = 1.5$ V, tested with DUT mounted to EVB

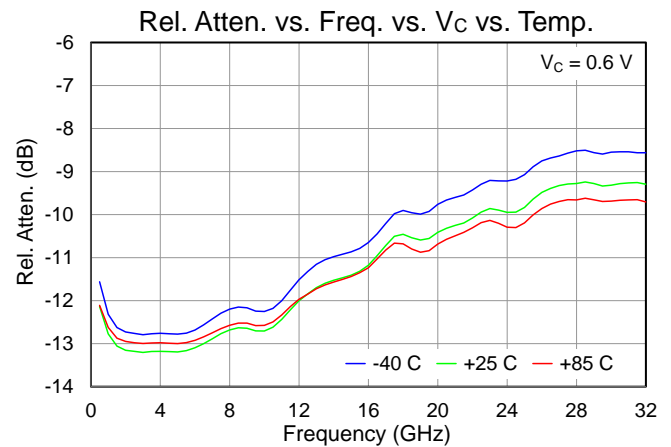
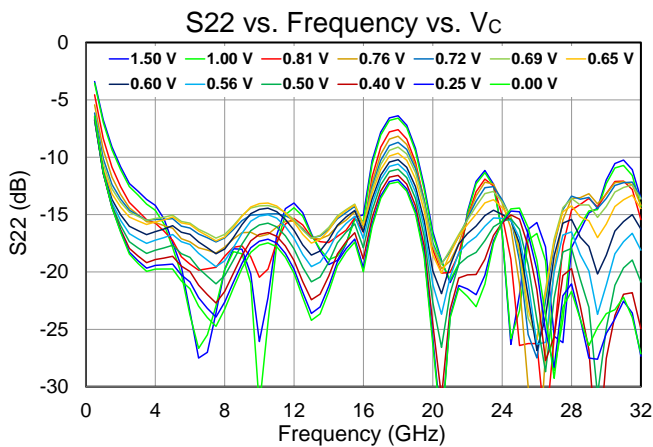
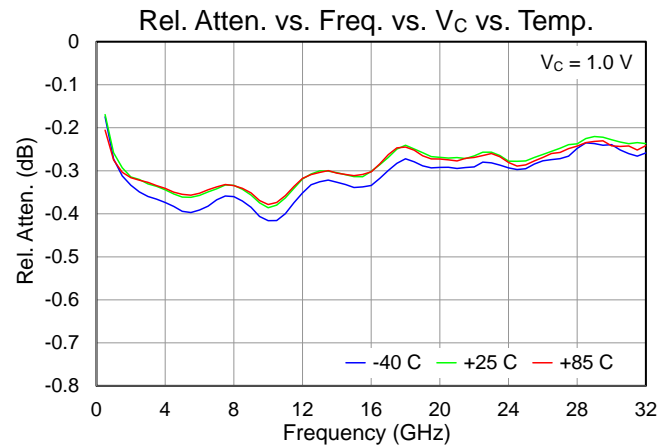
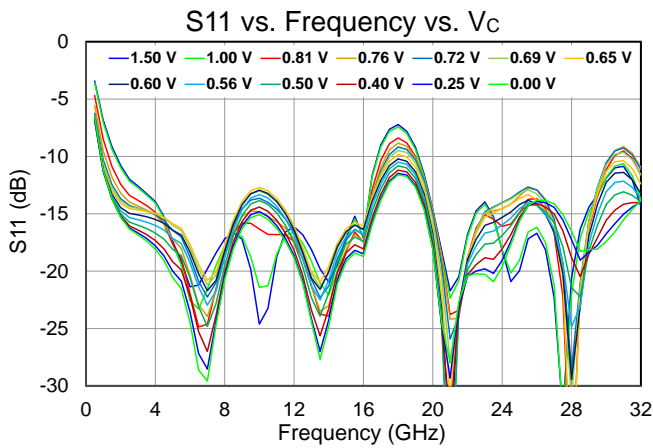
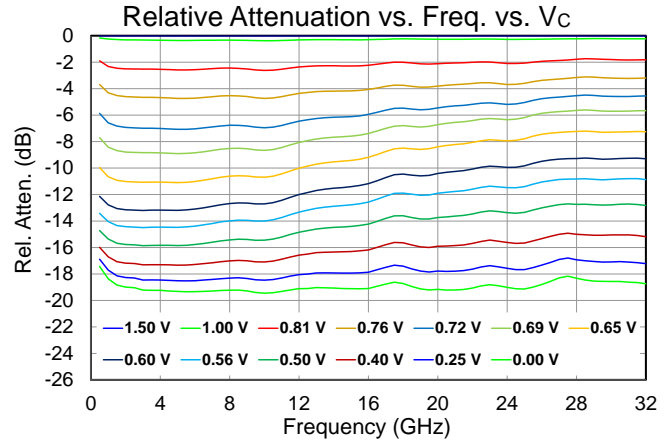
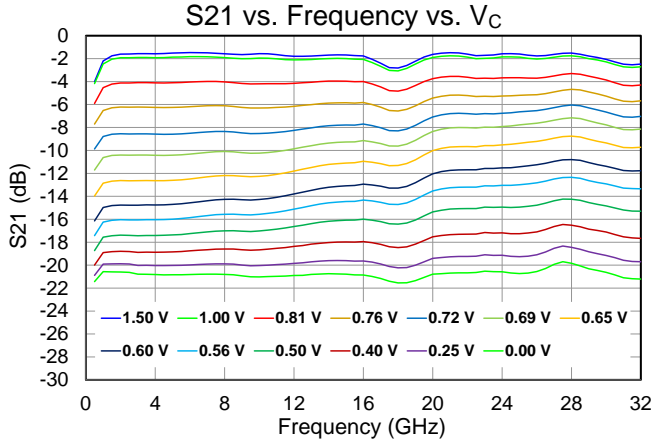

Performance Plots – Small Signal & Power Performance

Test conditions unless otherwise noted: Temp. = 25 °C, $V_S = 1.5$ V, tested with DUT mounted to EVB

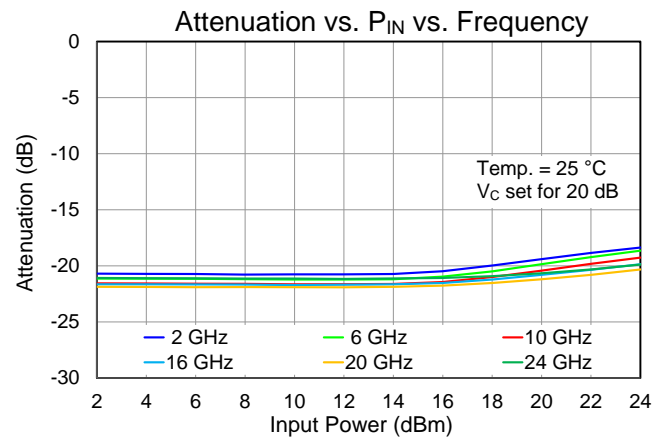
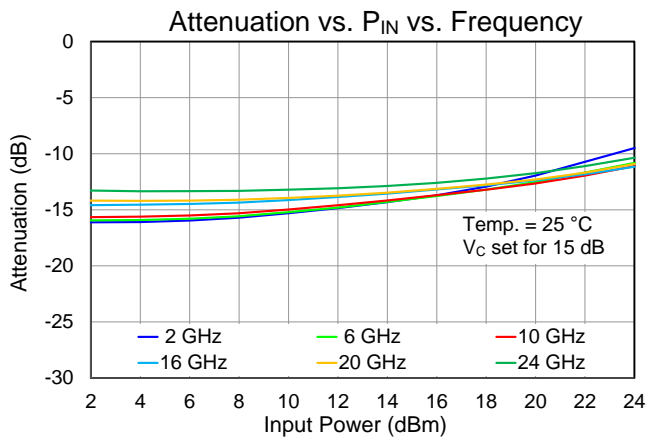
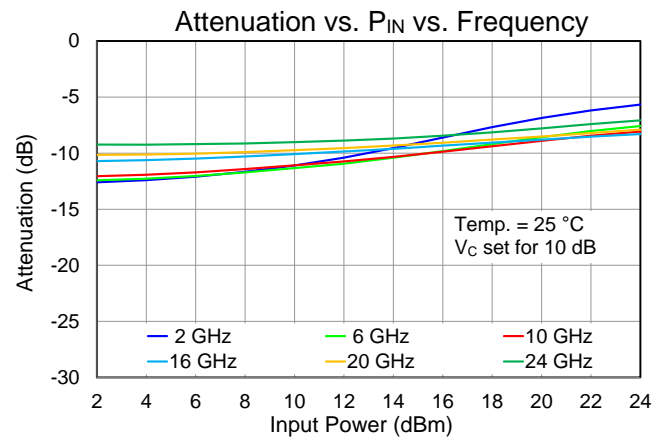
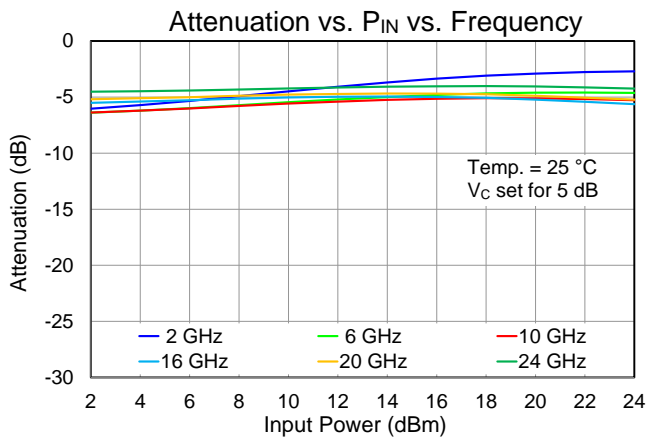
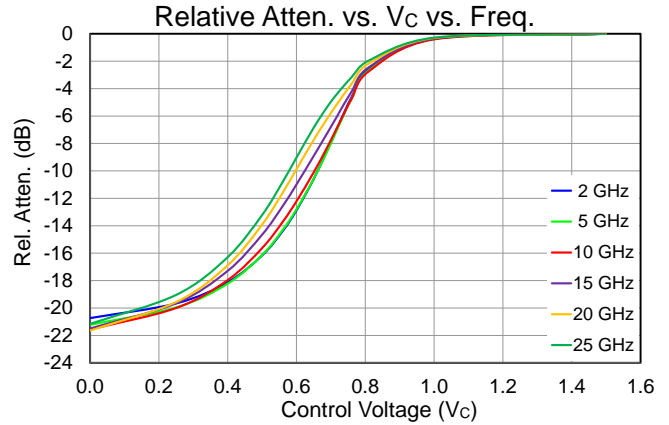
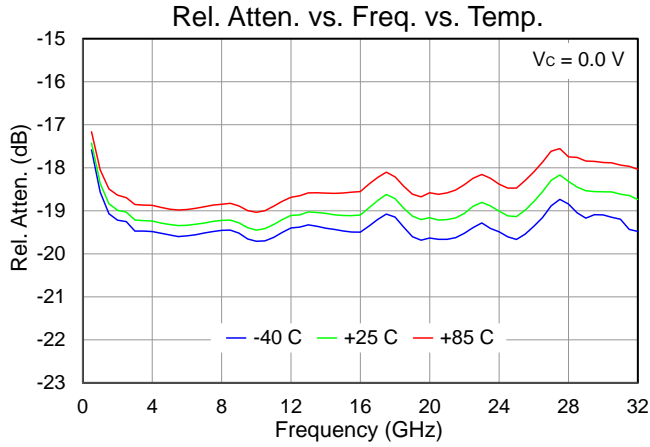

Performance Plots – Linearity

Test conditions unless otherwise noted: Temp. = 25 °C, $V_S = 1.5$ V, tested with DUT mounted to EVB

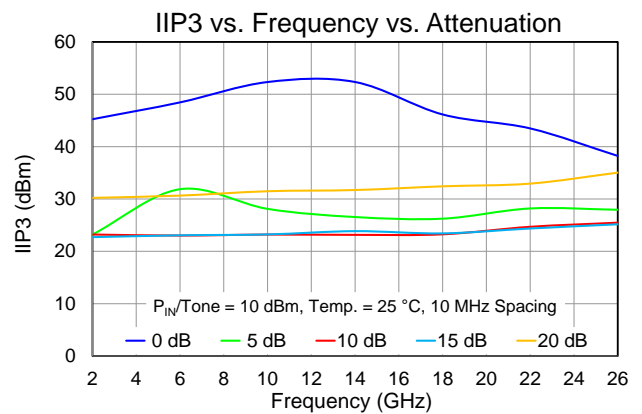
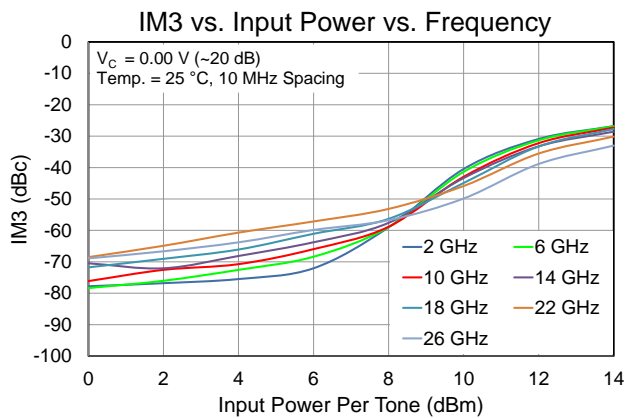
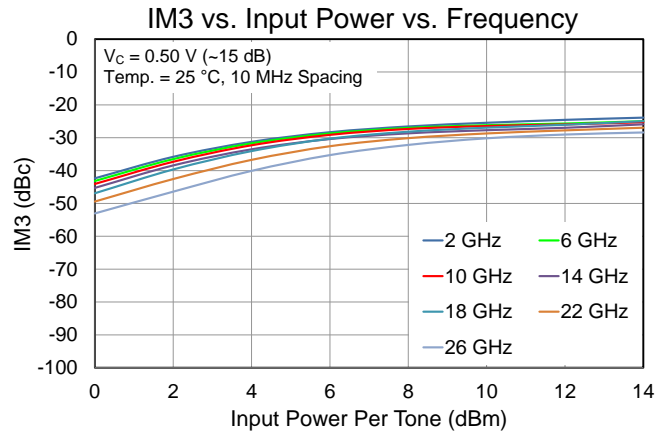
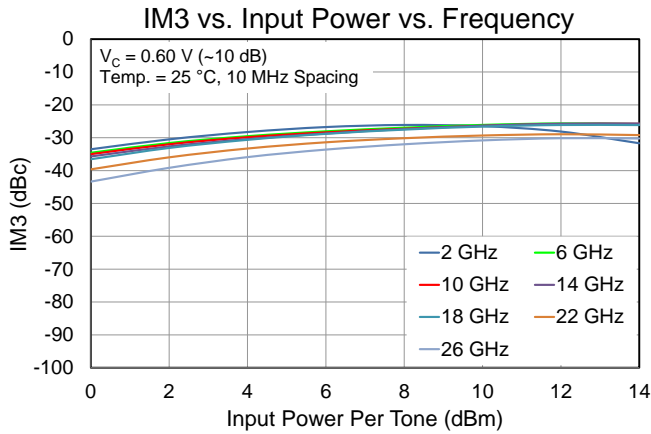
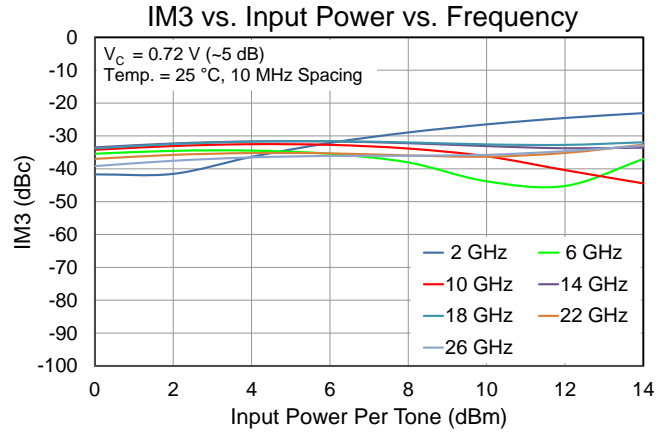
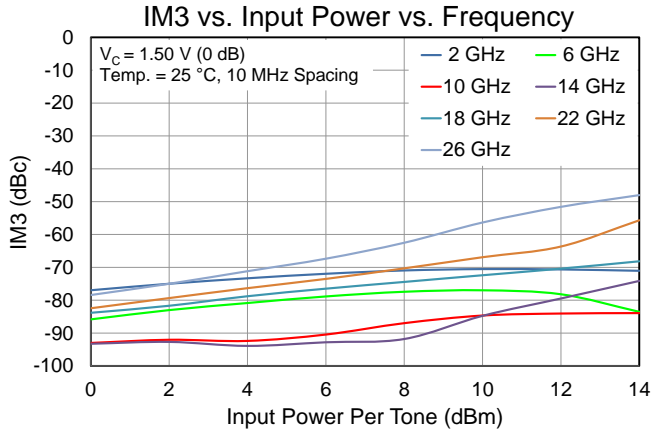

Thermal and Reliability Information

Parameter	Test Conditions	Value	Units
Thermal Resistance (θ_{JC}) ⁽¹⁾	$T_{BASE} = 85^{\circ}\text{C}$, $V_C = 0\text{ V}$, $P_{DISS} = 1.0\text{ W}$	40.0	$^{\circ}\text{C/W}$
Channel Temperature (T_{CH})		125	$^{\circ}\text{C}$
Median Lifetime (T_M)		2.4E+07	Hrs

1. Package base backside temperature fixed at 85 $^{\circ}\text{C}$.

Median Lifetime

Test Conditions: 6.0 V; Failure Criterion = 10% reduction in $I_{D\text{ MAX}}$

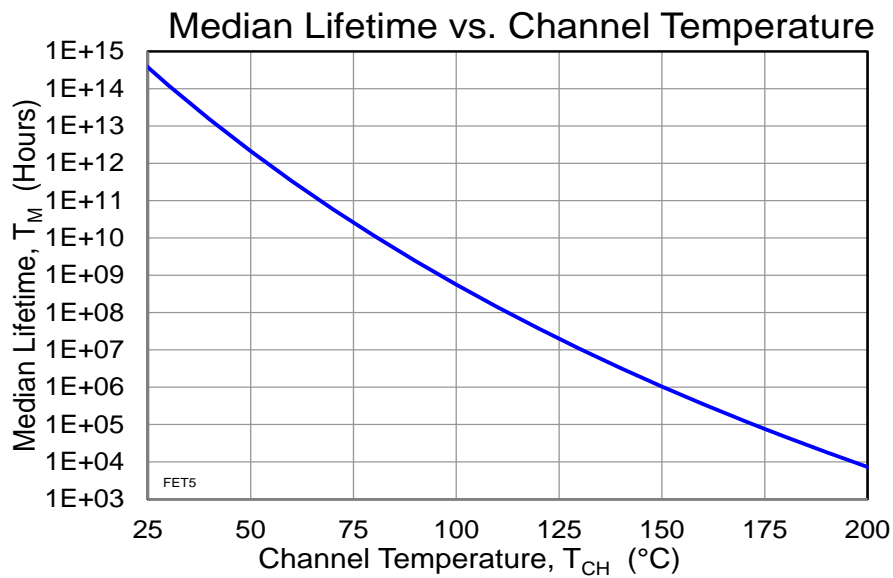

Applications Circuit and Pins Description

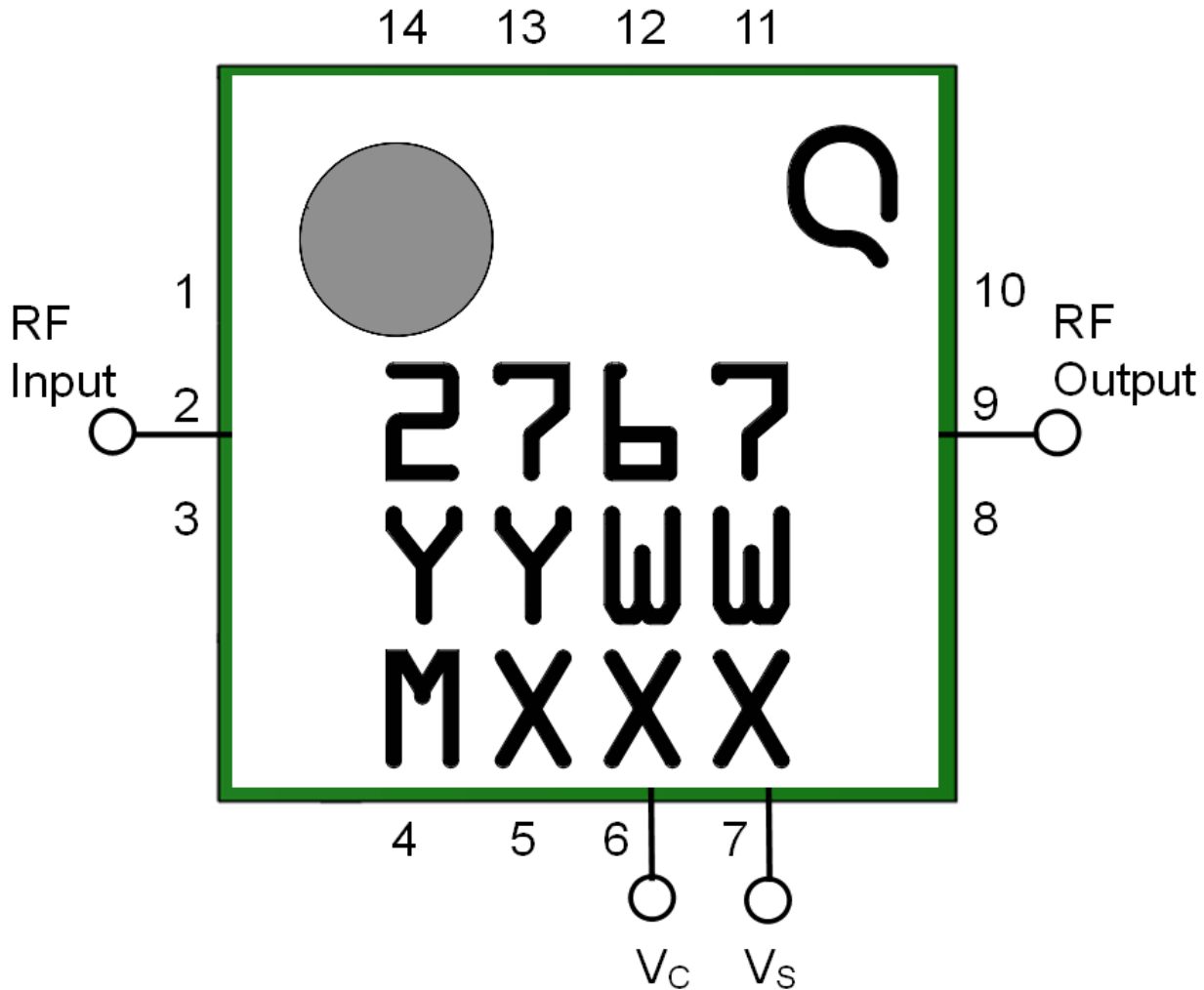

Notes: $V_c \leq V_s$

Pin No.	Symbol	Description
1, 3, 8, 10	GND	Package ground
2	RF Input	RF Input, 50 Ω , AC coupled
4, 5 11-14	NC	No connect; grounding may improve performance
6	V_c	V_c , control voltage
7	V_s	V_s , reference voltage
9	RF Output	RF Output, 50 Ω , AC coupled
15 (Slug)	GND	Backside Paddle: multiple vias should be used on PCB to minimize inductance and thermal resistance

Evaluation Board (EVB) Layout Assembly & Mounting Detail

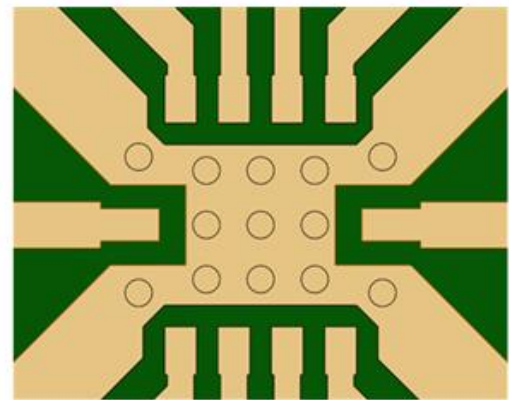
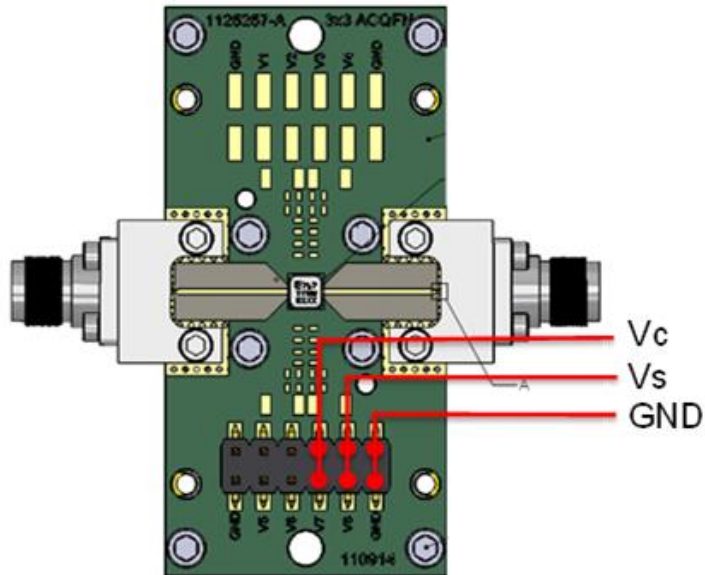

Package Mounting Detail

RF Layer is 0.008" thick Rogers Corp. RO4003C, $\epsilon_r = 3.38$. Metal layers are 0.5 oz. copper. The microstrip line at the connector interface is optimized for the Southwest Microwave end launch connector 1092-01A-5.

The pad pattern shown has been developed and tested for optimized assembly at Qorvo. The PCB land pattern has been developed to accommodate lead and package tolerances. Since surface mount processes vary from company to company, careful process development is recommended.

Note: Multiple vias should be employed under package to minimize inductance and thermal resistance.

Mechanical Information

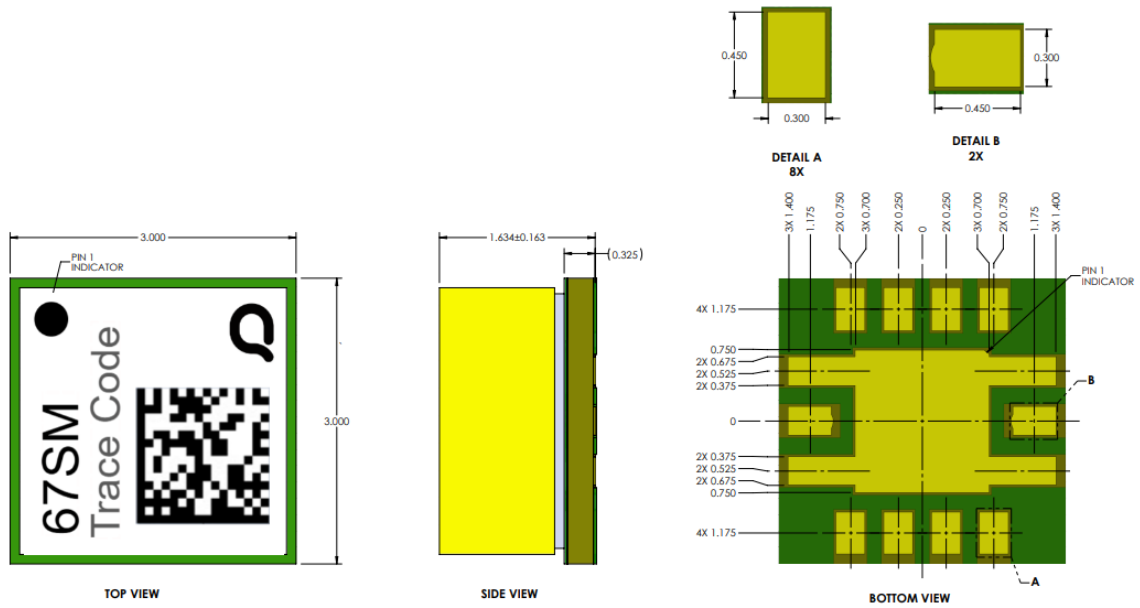

UNLESS OTHERWISE SPECIFIED DIMENSIONS ARE IN MILLIMETERS.
TOLERANCE IS: .XX = ±0.25; .XXX = ±0.100, and ANGLES = 0.5°

NOTES:

1. MATERIAL:
 - PACKAGE BASE: LAMIATE
 - PACKAGE LID: FR-4
2. PART IS EPOXY SEALED
3. ALL METALIZED FEATURES ARE GOLD PLATED:
4. PART MARKING:

- PIN 1 INDICATOR
- QORVO LOGO – USE Q5D
- TRACE CODE TO BE ASSIGNED BY SUBCON

Solderability

1. Compatible with the latest version of J-STD-020, Lead-free solder, maximum reflow temperature 260 °C.
2. Contact plating: ENEPIG (Thin Ni)

Recommended Soldering Profile

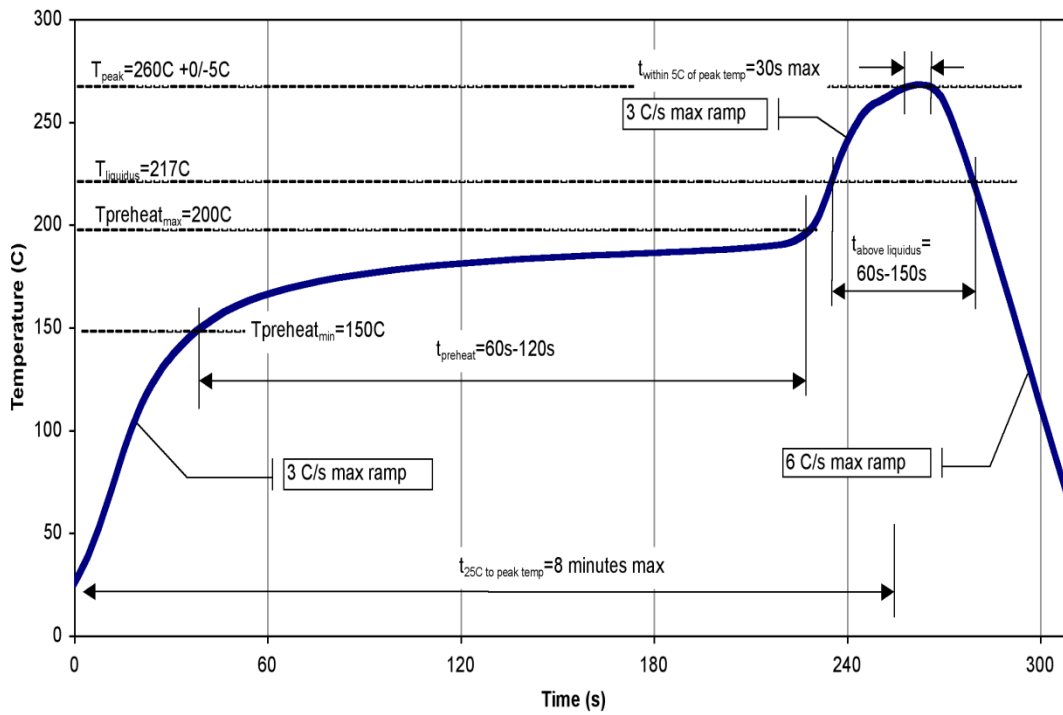

Handling Precautions

Parameter	Rating	Standard
ESD – Human Body Model (HBM)	Class 1B	ANSI/ESD/JEDEC JS-001
ESD – Charge Device Model (CDM)	Class C3	JS-002-2014
MSL – Moisture Sensitivity Level	Level 3	IPC/JEDEC J-STD-020



Caution!
ESD-Sensitive Device

RoHS Compliance

This product is compliant with the 2011/65/EU RoHS directive (Restrictions on the Use of Certain Hazardous Substances in Electrical and Electronic Equipment), as amended by Directive 2015/863/EU. This product also has the following attributes:

- Lead Free
- SVHC Free
- Antimony Free
- TBBP-A (C₁₅H₁₂Br₄O₂) Free
- PFOS Free

Contact Information

For the latest specifications, additional product information, worldwide sales and distribution locations:

Tel: **1-844-890-8163**

Web: www.qorvo.com

Email: customer.support@qorvo.com

Important Notice

The information contained herein is believed to be reliable; however, Qorvo makes no warranties regarding the information contained herein and assumes no responsibility or liability whatsoever for the use of the information contained herein. All information contained herein is subject to change without notice. Customers should obtain and verify the latest relevant information before placing orders for Qorvo products. The information contained herein or any use of such information does not grant, explicitly or implicitly, to any party any patent rights, licenses, or any other intellectual property rights, whether with regard to such information itself or anything described by such information. **THIS INFORMATION DOES NOT CONSTITUTE A WARRANTY WITH RESPECT TO THE PRODUCTS DESCRIBED HEREIN, AND QORVO HEREBY DISCLAIMS ANY AND ALL WARRANTIES WITH RESPECT TO SUCH PRODUCTS WHETHER EXPRESS OR IMPLIED BY LAW, COURSE OF DEALING, COURSE OF PERFORMANCE, USAGE OF TRADE OR OTHERWISE, INCLUDING THE IMPLIED WARRANTIES OF MERCHANTABILITY AND FITNESS FOR A PARTICULAR PURPOSE.**

Without limiting the generality of the foregoing, Qorvo products are not warranted or authorized for use as critical components in medical, life-saving, or life-sustaining applications, or other applications where a failure would reasonably be expected to cause severe personal injury or death.

Copyright 2025 © Qorvo, Inc. | Qorvo is a registered trademark of Qorvo, Inc.

Looking for pricing, stock, or lifecycle information?

Click below to explore more details on WIN SOURCE:

- ⊖ [View THJB106K016RJN on WIN SOURCE](#)
- ⊖ [AVX Corp/Kyocera Corp Information](#)

Optimize Your Supply Chain with WIN SOURCE Solutions

- ✓ Global Sourcing Solution
- ✓ Obsolete Management
- ✓ Cost Control Management
- ✓ Shortage Management
- ✓ Alternative Solution
- ✓ Excess Inventory Management