

XtremeSense™ TMR Current Sensor with Ultra-Low Noise and <1% Total Error

Not for New Design

The CT430 is in production but has been determined to be NOT FOR NEW DESIGN. This classification indicates that sale of this device is currently restricted to existing customer applications. The device should not be purchased for new design applications because obsolescence in the near future is probable. Samples are no longer available.

Date of status change: March 28, 2025

Recommended Substitutions:

For existing customer transition, and for new customers or new applications, refer to [CT432](#).

NOTE: For detailed information on purchasing options, contact your local Allegro field applications engineer or sales representative.

Allegro MicroSystems reserves the right to make, from time to time, revisions to the anticipated product life cycle plan for a product to accommodate changes in production capabilities, alternative product availabilities, or market demand. The information included herein is believed to be accurate and reliable. However, Allegro MicroSystems assumes no responsibility for its use; nor for any infringements of patents or other rights of third parties which may result from its use.

XtremeSense™ TMR Current Sensor with Ultra-Low Noise and <1% Total Error

FEATURES AND BENEFITS

- Integrated contact current sensing for low to medium current ranges:
 - 0 to 20 A □ 0 to 50 A
 - ±20 A □ ±50 A
 - 0 to 30 A □ 0 to 65 A
 - ±30 A □ ±65 A
- Integrated current carrying conductor (CCC)
- Linear analog output voltage
- Total error output $\leq \pm 1.0\%$ FS, -40°C to 125°C
- 1 MHz bandwidth
- Response time: ~ 300 ns
- UL/IEC 62368-1 and UL1577 certification
 - Rated isolation voltage: 5 kV_{RMS}
 - Working voltage for basic isolation: $1100\text{ V}_{\text{RMS}}$
 - Working voltage for reinforced isolation: $550\text{ V}_{\text{RMS}}$
- Low noise: 9 to $15\text{ mA}_{\text{RMS}}$ @ $f_{\text{BW}} = 100\text{ kHz}$
- Reference voltage output
- Immunity to common mode fields: -54 dB
- Supply voltage: 4.75 to 5.50 V
- Overcurrent detection
 - Out of range currents
- AEC-Q100 grade 1

PACKAGE:

Not to scale



16-lead SOICW

DESCRIPTION

The CT430 is a high bandwidth and ultra-low noise integrated contact current sensor that uses Allegro patented XtremeSense™ TMR technology to enable high accuracy current measurements for many industrial, consumer, and automotive applications. The device supports eight current ranges where the integrated current carrying conductor (CCC) will handle up to 65 A of current and generates a current measurement as a linear analog output voltage. The device achieves a total output error of less than $\pm 1.0\%$ full-scale (FS) over voltage and the full temperature range.

The device has a ~ 300 ns output response time while the current consumption is ~ 6.0 mA and is immune to common mode fields. The CT430 has an integrated overcurrent detection (OCD) circuitry to identify out of range currents (OCD) with the result output to the fault-bar ($\overline{\text{FLT}}$) pin. The $\overline{\text{FLT}}$ is an open drain, active low digital signal that is activated by the CT430 to alert the microcontroller that a fault condition has occurred.

The CT430 is offered in an industry-standard 16-lead SOIC wide package that is green and RoHS compliant.

APPLICATIONS

- Solar/power inverters
- UPS, SMPS, and telecom power supplies
- Battery management systems
- Motor control
- White goods
- Power utility meter
- Overcurrent fault protection



TÜV Certificate No.:
R 72226133 0001



UL Certificate No.:
UL-CA-2201235-0

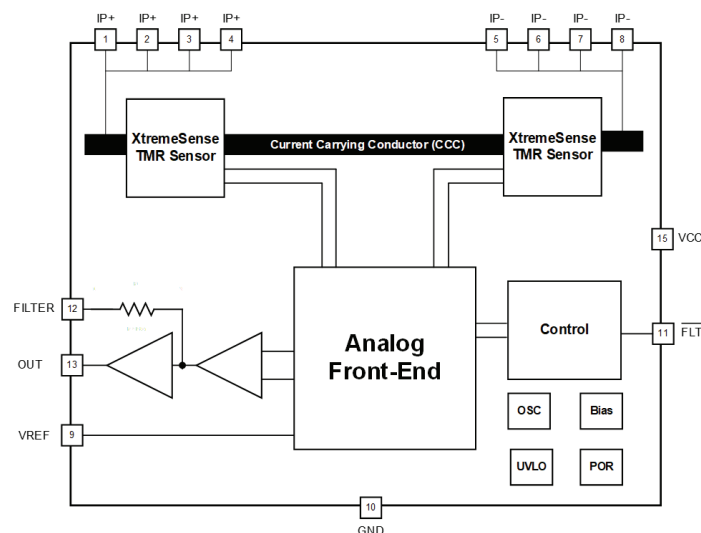

Figure 1: CT430 Functional Block Diagram for 16-lead SOICW Package

SELECTION GUIDE

Part Number	Current Range (I _P MAX) (A)	Sensitivity (mV/A)	Operating Temperature Range (°C)	Package	Packing
CT430-HSWF20MR	±20	100	-40 to 125	16-lead SOICW 10.21 mm × 10.31 mm × 2.54 mm	Tape and Reel
CT430-HSWF30MR	±30	66.7			
CT430-HSWF50MR	±50	40			
CT430-HSWF65MR	±65	30.8			
CT430-HSWF20DR	20	200			
CT430-HSWF30DR	30	133.3			
CT430-HSWF50DR	50	80			
CT430-HSWF65DR	65	61.5			
AEC-Q100 GRADE 1					
CT430-ASWF20MR	±20	100	Grade 1 -40 to 125	16-lead SOICW 10.21 mm × 10.31 mm × 2.54 mm	Tape and Reel
CT430-ASWF30MR	±30	66.7			
CT430-ASWF50MR	±50	40			
CT430-ASWF65MR	±65	30.8			
CT430-ASWF20DR	20	200			
CT430-ASWF30DR	30	133.3			
CT430-ASWF50DR	50	80			
CT430-ASWF65DR	65	61.5			

Table of Contents

Features and Benefits.....	1
Description	1
Applications.....	1
Package	1
Functional Block Diagram	1
Selection Guide	2
Absolute Maximum Ratings	3
Recommended Operating Conditions	3
Thermal Characteristics	3
Isolation Ratings	4
Pinout Diagram and Terminal List.....	5
Electrical Characteristics	6
Functional Description	20
Package Outline Drawing.....	26
Tape and Reel Pocket Drawing and Dimensions	27
Package Information.....	28
Device Marking	29
Part Ordering Number Legend	29
Revision History	30

ABSOLUTE MAXIMUM RATINGS [1]

Characteristic	Symbol	Notes	Rating	Unit
Supply Voltage Strength	V_{CC}		-0.3 to 6.0	V
Analog Input/Output Pins Maximum Voltage	$V_{I/O}$		-0.3 to $V_{CC} + 0.3$ [2]	V
Current Carrying Conductor Maximum Current	$I_{CCC(MAX)}$	$T_A = 25^\circ\text{C}$	70	A
Dielectric Surge Strength Test Voltage	V_{SURGE}	IEC 61000-4-5: Tested ± 5 Pulses at 2/60 seconds, 1.2 μs (rise) and 50 μs (width)	6.0 (min)	kV
Surge Strength Test Current	I_{SURGE}	Tested ± 5 Pulses at 3/60 seconds, 8.0 μs (rise) and 20 μs (width)	3.0 (min)	kA
Electrostatic Discharge Protection Level	ESD	Human Body Model (HBM) per JESD22-A114	± 2.0	kV
		Charged Device Model (CDM) per JESD22-C101	± 0.5	kV
Junction Temperature	T_J		-40 to 150	$^\circ\text{C}$
Storage Temperature	T_{STG}		-65 to 155	$^\circ\text{C}$
Lead Soldering Temperature	T_L	10 seconds	260	$^\circ\text{C}$

[1] Stresses exceeding the absolute maximum ratings may damage the CT430 and may not function or be operable above the recommended operating conditions and stressing the parts to these levels is not recommended. In addition, extended exposure to stresses above the recommended operating conditions may affect device reliability. The absolute maximum ratings are stress ratings only.

[2] The lower of $V_{CC} + 0.3$ V or 6.0 V.

RECOMMENDED OPERATING CONDITIONS [1]

Characteristic	Symbol	Notes	Min.	Typ.	Max.	Unit
Supply Voltage Range	V_{CC}		4.75	5.00	5.50	V
Output Voltage Range	V_{OUT}		0	-	V_{CC}	V
Output Current	I_{OUT}		-	-	± 1.0	mA
Operating Ambient Temperature	T_A	Industrial	-40	25	85	$^\circ\text{C}$
		Extended Industrial	-40	25	125	$^\circ\text{C}$
		Automotive	-40	25	125	$^\circ\text{C}$

[1] The Recommended Operating Conditions table defines the conditions for actual operation of the CT430. Recommended operating conditions are specified to ensure optimal performance to the specifications. Allegro does not recommend exceeding them or designing to absolute maximum ratings.

ISOLATION RATINGS

Characteristic	Symbol	Notes	Rating	Unit
Impulse Withstand Voltage	$V_{IMPULSE}$	Tested ± 5 pulses at 2/minute in compliance to IEC 61000-4-5 1.2 μs (rise) / 50 μs (width)	8000	V_{PK}
Dielectric Withstand Voltage	V_{ISO}	Agency rated for 60 seconds per UL 62368-1:2014 (edition 2) and per UL 1577 ^[1]	5000	V_{RMS}
Working Voltage for Basic Isolation	V_{WVBI}	Maximum approved working voltage for basic insulation according to UL 62368-1:2014 (edition 2)	1556	V_{PK}
			1100	V_{RMS}
Working Voltage for Reinforced Isolation	V_{WBRI}	Maximum approved working voltage for reinforced insulation according to UL 62368-1:2014 (edition 2)	778	V_{PK}
			550	V_{RMS}
Creepage Distance	D_{CR}	Minimum distance along package body from IP leads to signal leads.	7.8	mm
Clearance Distance	D_{CL}	Minimum distance through air from IP leads to signal leads	7.8	mm
Distance Through Isolation	DTI	Minimum internal distance through isolation	110	μm
Comparative Tracking Index	CTI	Material Group II	400 to 599	V

[1] 100% Production-tested for 1 second in accordance with UL 62368-1 (edition 2) and UL 1577.

PINOUT DIAGRAM AND TERMINAL LIST

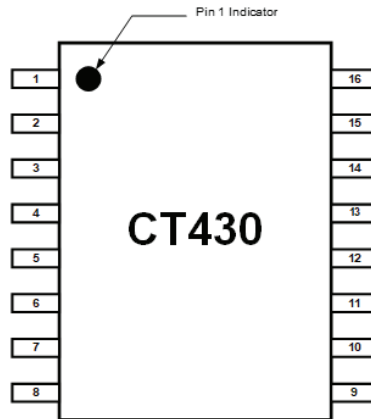

Figure 2: CT430 Pinout Diagram for 16-lead SOICW Package (Top-Down View)

Terminal List

Number	Name	Function
1, 2, 3, 4	IP+	Terminal for primary conductor (positive).
5, 6, 7, 8	IP-	Terminal for primary conductor (negative).
9	VREF	Reference voltage output. If not used, then do not connect.
10	GND	Ground.
11	$\overline{\text{FLT}}$	Active low output fault signal (open drain output) to indicate that the following parameters are outside of normal operational bounds: <ul style="list-style-type: none"> • Overcurrent Detection • UVLO If not used, then a 1.0 nF capacitor must be connected from the pin to ground.
12	FILTER	Filter pin to improve noise performance by connecting an external capacitor to set the cut-off frequency. If not used, then do not connect the pin (no connect).
13	OUT	Analog output voltage that represents the measured current.
14	NC	No connect.
15	VCC	Supply voltage.
16	NC	No connect.

ELECTRICAL CHARACTERISTICS: Valid for $V_{CC} = 4.75$ to 5.50 V, $C_{BYP} = 1.0$ μ F, and $T_A = -40^\circ$ C to 125° C, typical values are $V_{CC} = 5.00$ V and $T_A = 25^\circ$ C, unless otherwise specified

Characteristics	Symbol	Test Conditions	Min.	Typ.	Max.	Unit
POWER SUPPLIES						
Supply Current	I_{CC}	$f_{BW} = 1$ MHz, no load, $I_P = 0$ A	–	6.0	9.0	mA
OUT Maximum Drive Capability [1]	I_{OUT}	OUT covers 10% to 90% of V_{CC} span	–1.0	–	+1.0	mA
OUT Capacitive Load [1]	C_{L_OUT}		–	–	100	pF
OUT Resistive Load [1]	R_{L_OUT}		–	100	–	k Ω
Internal Filter Resistance	R_{FILTER}		–	15	–	k Ω
Primary Conductor Resistance [1]	R_P		–	1	–	m Ω
Power Supply Rejection Ratio [1]	PSRR		–	35	–	dB
Sensitivity Power Supply Rejection Ratio [1]	SPSRR		–	35	–	dB
Offset Power Supply Rejection Ratio [1]	OPSRR		–	40	–	dB
ANALOG OUTPUT (OUT)						
OUT Voltage Linear Range, Typical	V_{OUT}	$V_{SIG_AC} = \pm 2.00$ V, $V_{SIG_DC} = +4.00$ V	0.50	–	4.50	V
Output High Saturation Voltage	V_{OUT_SAT}	V_{OUT} , $T_A = 25^\circ$ C	$V_{CC} - 0.30$	$V_{CC} - 0.25$	–	V
Common Mode Field Rejection Ratio [1]	CMFRR		–	–54	–	dB
			–	0.5	–	mA/G
REFERENCE VOLTAGE (VREF)						
Reference Voltage	V_{REF}	DC Current (Unipolar)	–	0.50	–	V
		AC Current (Bipolar)	–	2.50	–	V
VREF Capacitive Load [1]	C_{L_VREF}		–	–	10	pF
VREF Resistive Load [1]	R_{L_VREF}		–	10	–	k Ω
VREF Maximum Drive Capability [1]	I_{VREF}		–50	–	50	μ A
FAULT OUTPUT (FLT)						
FLT Voltage Low	$V_{FLT\#_OL}$	$I_{FLT\#_OUT} \leq 20$ mA	0	–	0.5	V
High-Impedance Output Leakage Current	$I_{LEAK_FLT\#}$	$V_{FLT\#_OH} = V_{CC}$	–	5	–	μ A
FLT Pull-Up Resistor	R_{PU}		–	100	–	k Ω
TIMINGS						
Power-On Time [1]	t_{ON}	$V_{CC} \geq 2.50$ V	–	100	200	μ s
Rise Time [1]	t_{RISE}	$I_P = I_{RANGE(MAX)}$, $T_A = 25^\circ$ C, $C_L = 100$ pF	–	200	–	ns
Response Time [1]	$t_{RESPONSE}$	$I_P = I_{RANGE(MAX)}$, $T_A = 25^\circ$ C, $C_L = 100$ pF	–	300	–	ns
Propagation Delay [1]	t_{DELAY}	$I_P = I_{RANGE(MAX)}$, $T_A = 25^\circ$ C, $C_L = 100$ pF	–	250	–	ns
FLT Response Time	$t_{FLT\#}$		–	250	–	ns

[1] Guaranteed by design and characterization; not tested in production.

Continued on next page...

ELECTRICAL CHARACTERISTICS (continued): Valid for $V_{CC} = 4.75$ to 5.50 V, $C_{BYP} = 1.0$ μ F, and $T_A = -40^\circ\text{C}$ to 125°C , typical values are $V_{CC} = 5.00$ V and $T_A = 25^\circ\text{C}$, unless otherwise specified

Characteristics	Symbol	Test Conditions	Min.	Typ.	Max.	Unit
PROTECTION						
Undervoltage Lockout	V_{UVLO}	Rising V_{DD}	–	2.50	–	V
		Falling V_{DD}	–	2.45	–	V
UVLO Hysteresis	V_{UV_HYS}		–	50	–	mV
Overcurrent Detection (OCD) for DC Current (Unipolar)	I_{OCD_U}	Rising I_P	–	$1.1 \times I_{RANGE(MAX)}$	–	A
		Falling I_P	–	$0.9 \times I_{RANGE(MAX)}$	–	A
Overcurrent Detection (OCD) for AC Current (Bipolar)	I_{OCD_B}	Rising I_P	–	$1.1 \times I_{RANGE(MAX)}$	–	A
		Falling I_P	–	$0.9 \times I_{RANGE(MAX)}$	–	A
Overcurrent Detection Hysteresis	I_{OCD_HYS}		–	$0.2 \times I_{RANGE(MAX)}$	–	A

ELECTRICAL CHARACTERISTICS

$V_{CC} = 5.00\text{ V}$, $T_A = 25^\circ\text{C}$, and $C_{BYP} = 1.0\ \mu\text{F}$ (unless otherwise specified)

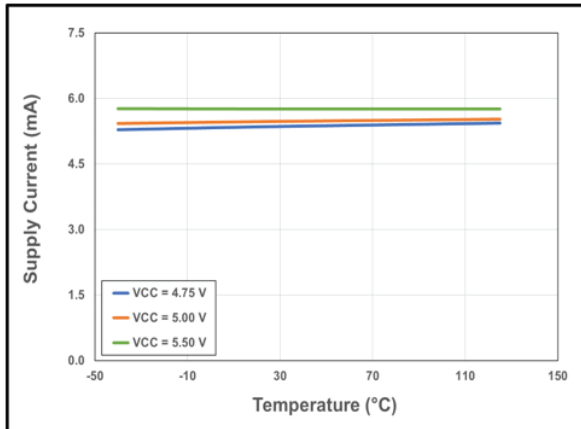

Figure 3: CT430 Supply Current vs. Temperature vs. Supply Voltage

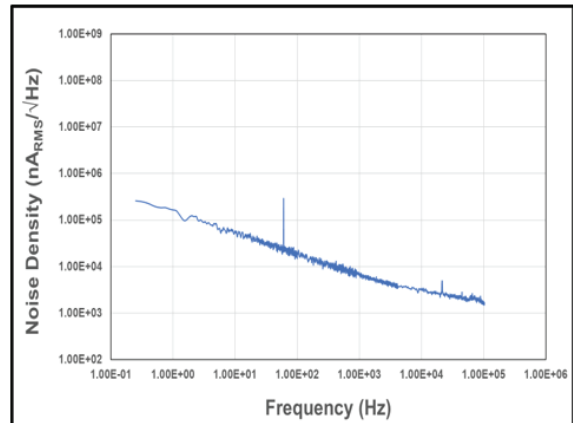

Figure 6: Noise Density vs. Frequency

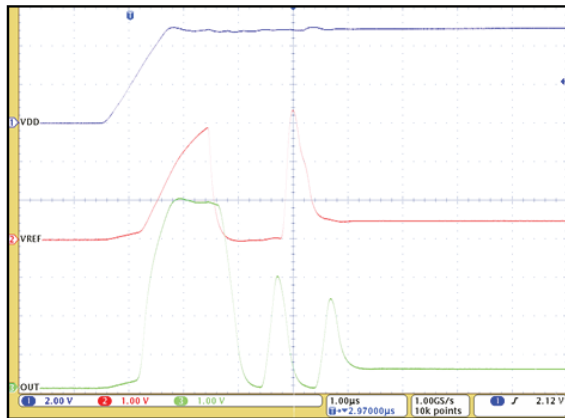

Figure 4: CT430 Startup Waveforms for $V_{OQ} = 0.50\text{ V}$ (DC Current)

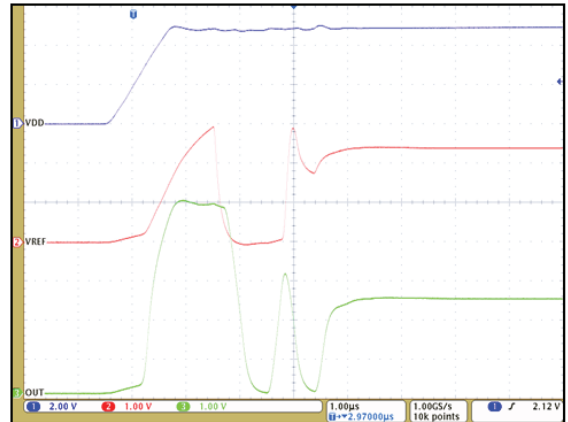

Figure 5: CT430 Startup Waveforms for $V_{OQ} = 2.50\text{ V}$ (AC Current)

ELECTRICAL CHARACTERISTICS (continued)

$V_{CC} = 5.00\text{ V}$, $T_A = 25^\circ\text{C}$, and $C_{BYP} = 1.0\ \mu\text{F}$ (unless otherwise specified)

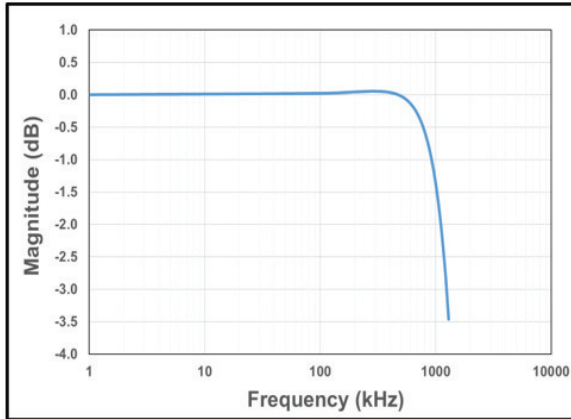

Figure 7: CT430 Bandwidth with $C_{FILTER} = 1.0\ \text{pF}$

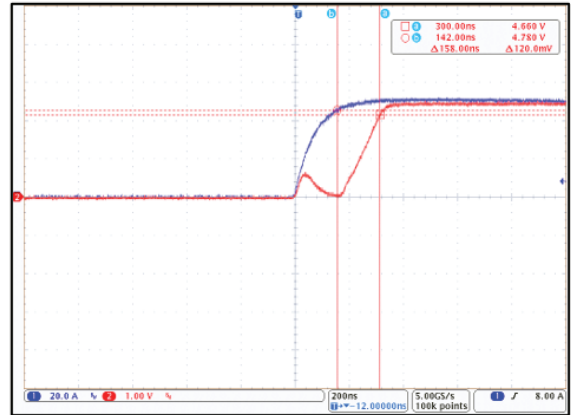

Figure 8: CT430 Response Time; $I_P = 50\ \text{A}_{PK}$ and $C_L = 100\ \text{pF}$ (Blue = I_{CC} , Red = V_{OUT})

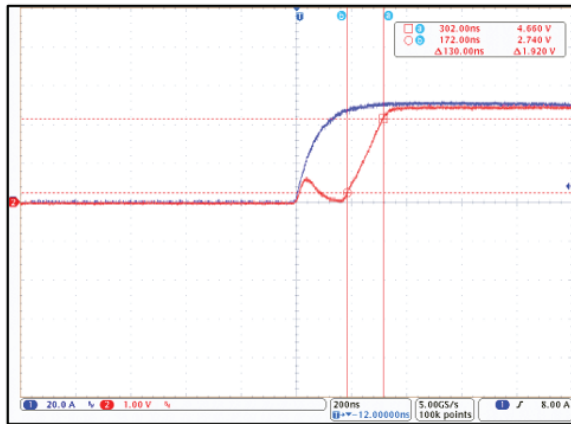

Figure 9: CT430 Rise Time; $I_P = 50\ \text{A}_{PK}$ and $C_L = 100\ \text{pF}$ (Blue = I_{CC} , Red = V_{OUT})

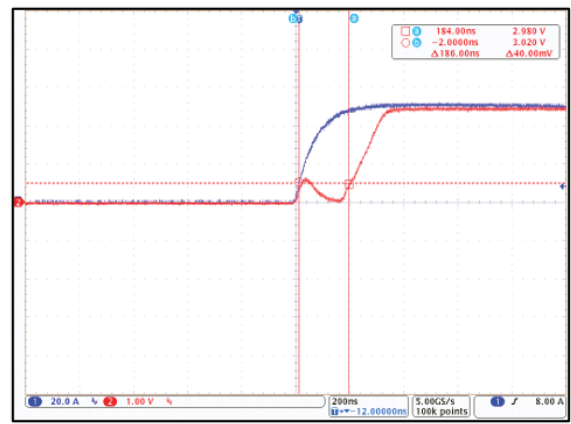

Figure 10: CT430 Propagation Delay; $I_P = 50\ \text{A}_{PK}$ and $C_L = 100\ \text{pF}$ (Blue = I_{CC} , Red = V_{OUT})

ELECTRICAL CHARACTERISTICS (continued)

$V_{CC} = 5.00\text{ V}$, $T_A = 25^\circ\text{C}$, and $C_{BYP} = 1.0\ \mu\text{F}$ (unless otherwise specified)

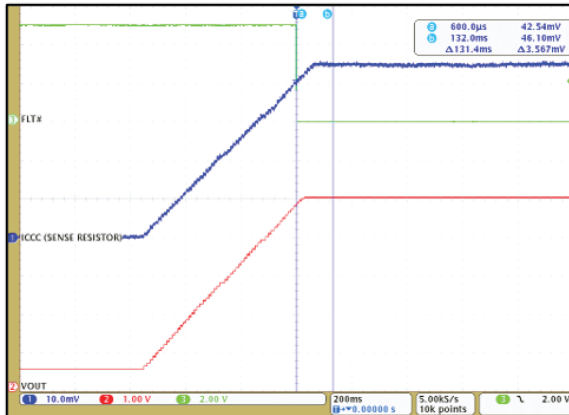

Figure 11: CT430 OCD enabled at 110% of 50 A_{DC} and $\overline{\text{FLT}}$ is Low

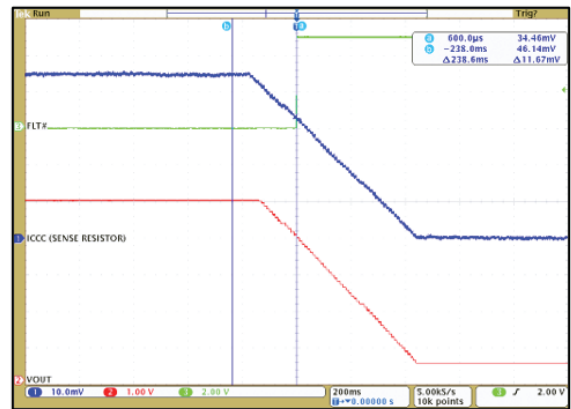

Figure 12: CT430 OCD disabled at 90% of 50 A_{DC} and $\overline{\text{FLT}}$ is High

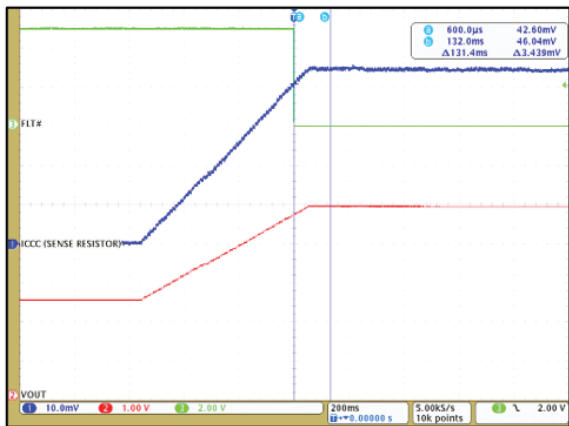

Figure 13: CT430 OCD enabled at 110% of 50 A_{PK} and $\overline{\text{FLT}}$ is Low

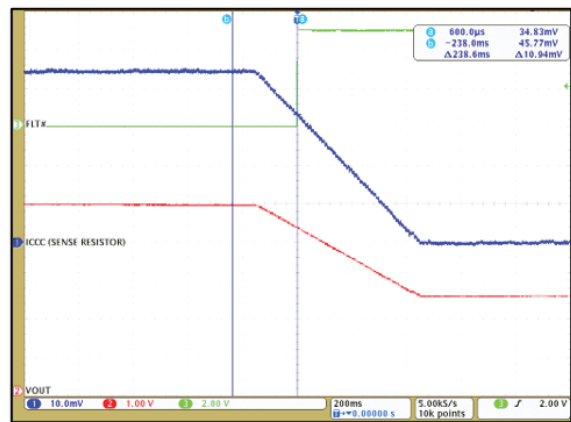

Figure 14: CT430 OCD disabled at 90% of 50 A_{PK} and $\overline{\text{FLT}}$ is High

ELECTRICAL CHARACTERISTICS (continued)

$V_{CC} = 5.00\text{ V}$, $T_A = 25^\circ\text{C}$, and $C_{BYP} = 1.0\ \mu\text{F}$ (unless otherwise specified)

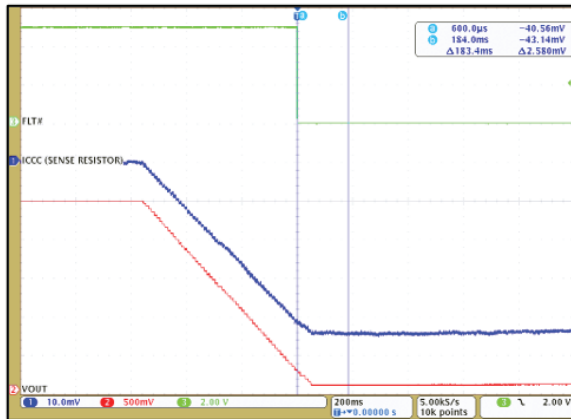

Figure 15: CT430 OCD enabled at -110% of -50 A_{PK} and $\overline{\text{FLT}}$ is Low

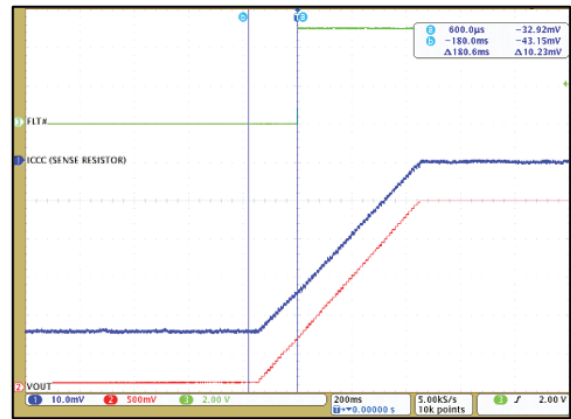

Figure 16: CT430 OCD disabled at -90% of -50 A_{PK} and $\overline{\text{FLT}}$ is High

CT430-xSWF20DR: 0 to 20 A – PERFORMANCE CHARACTERISTICS: Valid for $V_{CC} = 4.75$ to 5.50 V, $C_{BYP} = 1.0$ μ F, and $T_A = -40^\circ\text{C}$ to 125°C , unless otherwise specified

Characteristics	Symbol	Test Conditions	Min.	Typ. ^[1]	Max.	Unit
Current Range	I_{RANGE}		0	–	20	A
Voltage Output Quiescent	V_{OQ}	$T_A = 25^\circ\text{C}$, $I_P = 0$ A	0.495	0.500	0.505	V
Sensitivity	S	$I_{RANGE(MIN)} < I_P < I_{RANGE(MAX)}$	–	200	–	mV/A
Bandwidth [1]	f_{BW}	Small Signal = –3 dB	–	1.0	–	MHz
Noise [1]	e_N	$T_A = 25^\circ\text{C}$, $f_{BW} = 100$ kHz	–	9.0	–	mA_{RMS}
OUT ACCURACY PERFORMANCE						
Total Output Error	E_{TOT}	I_P sweep from $I_{P(MIN)}$ to $I_{P(MAX)}$	–	–	± 1.0	% FS
Linearity Error	E_{LIN}	$I_P = I_{P(MAX)}$, $T_A = -40^\circ\text{C}$ to 125°C	–	± 0.2	–	% FS
Sensitivity Error	E_{SENS}	$I_P = I_{P(MAX)}$, $T_A = 25^\circ\text{C}$	–	± 0.2	–	%
		$I_P = I_{P(MAX)}$, $T_A = 125^\circ\text{C}$	–	± 1.3	–	%
		$I_P = I_{P(MAX)}$, $T_A = -40^\circ\text{C}$	–	± 1.2	–	%
Offset Voltage Error	V_{OE}	$I_P = 0$ A, $T_A = 25^\circ\text{C}$	–	± 3	–	mV
		$I_P = 0$ A, $T_A = 125^\circ\text{C}$	–	± 19	–	mV
		$I_P = 0$ A, $T_A = -40^\circ\text{C}$	–	± 13	–	mV
LIFETIME DRIFT						
Total Error Including Lifetime Drift	$E_{TOT(DRIFT)}$	$I_P = I_{P(MAX)}$, $T_A = -40^\circ\text{C}$ to 125°C	–	± 1.9	–	% FS
Sensitivity Error Including Lifetime Drift	$E_{SENS(DRIFT)}$	$I_P = I_{P(MAX)}$, $T_A = -40^\circ\text{C}$ to 125°C	–	± 2.0	–	%
Offset Voltage Error Including Lifetime Drift	$V_{OE(DRIFT)}$	$I_P = 0$ A, $T_A = -40^\circ\text{C}$ to 125°C	–	± 26	–	mV

[1] Typical values are the mean ± 3 sigma of production distributions. These are formatted as mean ± 3 sigma.

[2] Lifetime drift characteristics are based on a statistical combination of production distributions and worst case distribution of parametric drift of individuals observed during AEC-Q100 qualification.

CT430-xSWF20MR: ±20 A – PERFORMANCE CHARACTERISTICS: Valid for $V_{CC} = 4.75$ to 5.50 V, $C_{BYP} = 1.0$ μ F, and $T_A = -40^\circ\text{C}$ to 125°C , unless otherwise specified

Characteristics	Symbol	Test Conditions	Min.	Typ. ^[1]	Max.	Unit
Current Range	I_{RANGE}		-20	-	20	A
Voltage Output Quiescent	V_{OQ}	$T_A = 25^\circ\text{C}$, $I_P = 0$ A	2.495	2.500	2.505	V
Sensitivity	S	$I_{RANGE(MIN)} < I_P < I_{RANGE(MAX)}$	-	100	-	mV/A
Bandwidth [1]	f_{BW}	Small Signal = -3 dB	-	1.0	-	MHz
Noise [1]	e_N	$T_A = 25^\circ\text{C}$, $f_{BW} = 100$ kHz	-	10.0	-	mA_{RMS}
OUT ACCURACY PERFORMANCE						
Total Output Error	E_{TOT}	I_P sweep from $I_{P(MIN)}$ to $I_{P(MAX)}$	-	-	±1.0	% FS
Linearity Error	E_{LIN}	$I_P = I_{P(MAX)}$, $T_A = -40^\circ\text{C}$ to 125°C	-	±0.1	-	% FS
Sensitivity Error	E_{SENS}	$I_P = I_{P(MAX)}$, $T_A = 25^\circ\text{C}$	-	±0.1	-	%
		$I_P = I_{P(MAX)}$, $T_A = 125^\circ\text{C}$	-	±1.4	-	%
		$I_P = I_{P(MAX)}$, $T_A = -40^\circ\text{C}$	-	±1.4	-	%
Offset Voltage Error	V_{OE}	$I_P = 0$ A, $T_A = 25^\circ\text{C}$	-	±2	-	mV
		$I_P = 0$ A, $T_A = 125^\circ\text{C}$	-	±13	-	mV
		$I_P = 0$ A, $T_A = -40^\circ\text{C}$	-	±16	-	mV
LIFETIME DRIFT						
Total Error Including Lifetime Drift	$E_{TOT(DRIFT)}$	$I_P = I_{P(MAX)}$, $T_A = -40^\circ\text{C}$ to 125°C	-	±1.9	-	% FS
Sensitivity Error Including Lifetime Drift	$E_{SENS(DRIFT)}$	$I_P = I_{P(MAX)}$, $T_A = -40^\circ\text{C}$ to 125°C	-	±2.2	-	%
Offset Voltage Error Including Lifetime Drift	$V_{OE(DRIFT)}$	$I_P = 0$ A, $T_A = -40^\circ\text{C}$ to 125°C	-	±29	-	mV

[1] Typical values are the mean ±3 sigma of production distributions. These are formatted as mean ±3 sigma.

[2] Lifetime drift characteristics are based on a statistical combination of production distributions and worst case distribution of parametric drift of individuals observed during AEC-Q100 qualification.

CT430-xSWF30DR: 0 to 30 A – PERFORMANCE CHARACTERISTICS: Valid for $V_{CC} = 4.75$ to 5.50 V, $C_{BYP} = 1.0$ μ F, and $T_A = -40^\circ\text{C}$ to 125°C , unless otherwise specified

Characteristics	Symbol	Test Conditions	Min.	Typ. ^[1]	Max.	Unit
Current Range	I_{RANGE}		0	–	30	A
Voltage Output Quiescent	V_{OQ}	$T_A = 25^\circ\text{C}$, $I_P = 0$ A	0.495	0.500	0.505	V
Sensitivity	S	$I_{RANGE(MIN)} < I_P < I_{RANGE(MAX)}$	–	133.3	–	mV/A
Bandwidth [1]	f_{BW}	Small Signal = –3 dB	–	1.0	–	MHz
Noise [1]	e_N	$T_A = 25^\circ\text{C}$, $f_{BW} = 100$ kHz	–	10.0	–	mA_{RMS}
OUT ACCURACY PERFORMANCE						
Total Output Error	E_{TOT}	I_P sweep from $I_{P(MIN)}$ to $I_{P(MAX)}$	–	–	± 1.0	% FS
Linearity Error	E_{LIN}	$I_P = I_{P(MAX)}$, $T_A = -40^\circ\text{C}$ to 125°C	–	± 0.3	–	% FS
Sensitivity Error	E_{SENS}	$I_P = I_{P(MAX)}$, $T_A = 25^\circ\text{C}$	–	± 0.2	–	%
		$I_P = I_{P(MAX)}$, $T_A = 125^\circ\text{C}$	–	± 1.2	–	%
		$I_P = I_{P(MAX)}$, $T_A = -40^\circ\text{C}$	–	± 1.1	–	%
Offset Voltage Error	V_{OE}	$I_P = 0$ A, $T_A = 25^\circ\text{C}$	–	± 2	–	mV
		$I_P = 0$ A, $T_A = 125^\circ\text{C}$	–	± 12	–	mV
		$I_P = 0$ A, $T_A = -40^\circ\text{C}$	–	± 11	–	mV
LIFETIME DRIFT						
Total Error Including Lifetime Drift	$E_{TOT(DRIFT)}$	$I_P = I_{P(MAX)}$, $T_A = -40^\circ\text{C}$ to 125°C	–	± 1.9	–	% FS
Sensitivity Error Including Lifetime Drift	$E_{SENS(DRIFT)}$	$I_P = I_{P(MAX)}$, $T_A = -40^\circ\text{C}$ to 125°C	–	± 1.9	–	%
Offset Voltage Error Including Lifetime Drift	$V_{OE(DRIFT)}$	$I_P = 0$ A, $T_A = -40^\circ\text{C}$ to 125°C	–	± 25	–	mV

[1] Typical values are the mean ± 3 sigma of production distributions. These are formatted as mean ± 3 sigma.

[2] Lifetime drift characteristics are based on a statistical combination of production distributions and worst case distribution of parametric drift of individuals observed during AEC-Q100 qualification.

CT430-xSWF30MR: ±30 A – PERFORMANCE CHARACTERISTICS: Valid for $V_{CC} = 4.75$ to 5.50 V, $C_{BYP} = 1.0$ μ F, and $T_A = -40^\circ\text{C}$ to 125°C , unless otherwise specified

Characteristics	Symbol	Test Conditions	Min.	Typ. ^[1]	Max.	Unit
Current Range	I_{RANGE}		-30	-	30	A
Voltage Output Quiescent	V_{OQ}	$T_A = 25^\circ\text{C}$, $I_P = 0$ A	2.495	2.500	2.505	V
Sensitivity	S	$I_{RANGE(MIN)} < I_P < I_{RANGE(MAX)}$	-	66.7	-	mV/A
Bandwidth [1]	f_{BW}	Small Signal = -3 dB	-	1.0	-	MHz
Noise [1]	e_N	$T_A = 25^\circ\text{C}$, $f_{BW} = 100$ kHz	-	11.5	-	mA_{RMS}
OUT ACCURACY PERFORMANCE						
Total Output Error	E_{TOT}	I_P sweep from $I_{P(MIN)}$ to $I_{P(MAX)}$	-	-	± 1.0	% FS
Linearity Error	E_{LIN}	$I_P = I_{P(MAX)}$, $T_A = -40^\circ\text{C}$ to 125°C	-	± 0.2	-	% FS
Sensitivity Error	E_{SENS}	$I_P = I_{P(MAX)}$, $T_A = 25^\circ\text{C}$	-	± 0.2	-	%
		$I_P = I_{P(MAX)}$, $T_A = 125^\circ\text{C}$	-	± 1.3	-	%
		$I_P = I_{P(MAX)}$, $T_A = -40^\circ\text{C}$	-	± 1.0	-	%
Offset Voltage Error	V_{OE}	$I_P = 0$ A, $T_A = 25^\circ\text{C}$	-	± 2	-	mV
		$I_P = 0$ A, $T_A = 125^\circ\text{C}$	-	± 12	-	mV
		$I_P = 0$ A, $T_A = -40^\circ\text{C}$	-	± 19	-	mV
LIFETIME DRIFT						
Total Error Including Lifetime Drift	$E_{TOT(DRIFT)}$	$I_P = I_{P(MAX)}$, $T_A = -40^\circ\text{C}$ to 125°C	-	± 1.9	-	% FS
Sensitivity Error Including Lifetime Drift	$E_{SENS(DRIFT)}$	$I_P = I_{P(MAX)}$, $T_A = -40^\circ\text{C}$ to 125°C	-	± 2.0	-	%
Offset Voltage Error Including Lifetime Drift	$V_{OE(DRIFT)}$	$I_P = 0$ A, $T_A = -40^\circ\text{C}$ to 125°C	-	± 31	-	mV

[1] Typical values are the mean ± 3 sigma of production distributions. These are formatted as mean ± 3 sigma.

[2] Lifetime drift characteristics are based on a statistical combination of production distributions and worst case distribution of parametric drift of individuals observed during AEC-Q100 qualification.

CT430-xSWF50DR: 0 to 50 A – PERFORMANCE CHARACTERISTICS: Valid for $V_{CC} = 4.75$ to 5.50 V, $C_{BYP} = 1.0$ μ F, and $T_A = -40^\circ\text{C}$ to 125°C , unless otherwise specified

Characteristics	Symbol	Test Conditions	Min.	Typ. ^[1]	Max.	Unit
Current Range	I_{RANGE}		0	–	50	A
Voltage Output Quiescent	V_{OQ}	$T_A = 25^\circ\text{C}$, $I_P = 0$ A	0.495	0.500	0.505	V
Sensitivity	S	$I_{RANGE(MIN)} < I_P < I_{RANGE(MAX)}$	–	80	–	mV/A
Bandwidth [1]	f_{BW}	Small Signal = –3 dB	–	1.0	–	MHz
Noise [1]	e_N	$T_A = 25^\circ\text{C}$, $f_{BW} = 100$ kHz	–	10.0	–	mA_{RMS}
OUT ACCURACY PERFORMANCE						
Total Output Error	E_{TOT}	I_P sweep from $I_{P(MIN)}$ to $I_{P(MAX)}$	–	–	± 1.0	% FS
Linearity Error	E_{LIN}	$I_P = I_{P(MAX)}$, $T_A = -40^\circ\text{C}$ to 125°C	–	± 0.2	–	% FS
Sensitivity Error	E_{SENS}	$I_P = I_{P(MAX)}$, $T_A = 25^\circ\text{C}$	–	± 0.2	–	%
		$I_P = I_{P(MAX)}$, $T_A = 125^\circ\text{C}$	–	± 1.6	–	%
		$I_P = I_{P(MAX)}$, $T_A = -40^\circ\text{C}$	–	± 1.4	–	%
Offset Voltage Error	V_{OE}	$I_P = 0$ A, $T_A = 25^\circ\text{C}$	–	± 5	–	mV
		$I_P = 0$ A, $T_A = 125^\circ\text{C}$	–	± 10	–	mV
		$I_P = 0$ A, $T_A = -40^\circ\text{C}$	–	± 16	–	mV
LIFETIME DRIFT						
Total Error Including Lifetime Drift	$E_{TOT(DRIFT)}$	$I_P = I_{P(MAX)}$, $T_A = -40^\circ\text{C}$ to 125°C	–	± 2.5	–	% FS
Sensitivity Error Including Lifetime Drift	$E_{SENS(DRIFT)}$	$I_P = I_{P(MAX)}$, $T_A = -40^\circ\text{C}$ to 125°C	–	± 2.2	–	%
Offset Voltage Error Including Lifetime Drift	$V_{OE(DRIFT)}$	$I_P = 0$ A, $T_A = -40^\circ\text{C}$ to 125°C	–	± 29	–	mV

[1] Typical values are the mean ± 3 sigma of production distributions. These are formatted as mean ± 3 sigma.

[2] Lifetime drift characteristics are based on a statistical combination of production distributions and worst case distribution of parametric drift of individuals observed during AEC-Q100 qualification.

CT430-xSWF50MR: ±50 A – PERFORMANCE CHARACTERISTICS: Valid for $V_{CC} = 4.75$ to 5.50 V, $C_{BYP} = 1.0$ μ F, and $T_A = -40^\circ\text{C}$ to 125°C , unless otherwise specified

Characteristics	Symbol	Test Conditions	Min.	Typ. ^[1]	Max.	Unit
Current Range	I_{RANGE}		-50	-	50	A
Voltage Output Quiescent	V_{OQ}	$T_A = 25^\circ\text{C}$, $I_P = 0$ A	2.495	2.500	2.505	V
Sensitivity	S	$I_{RANGE(MIN)} < I_P < I_{RANGE(MAX)}$	-	40	-	mV/A
Bandwidth [1]	f_{BW}	Small Signal = -3 dB	-	1.0	-	MHz
Noise [1]	e_N	$T_A = 25^\circ\text{C}$, $f_{BW} = 100$ kHz	-	14.0	-	mA_{RMS}
OUT ACCURACY PERFORMANCE						
Total Output Error	E_{TOT}	I_P sweep from $I_{P(MIN)}$ to $I_{P(MAX)}$	-	-	± 1.0	% FS
Linearity Error	E_{LIN}	$I_P = I_{P(MAX)}$, $T_A = -40^\circ\text{C}$ to 125°C	-	± 0.2	-	% FS
Sensitivity Error	E_{SENS}	$I_P = I_{P(MAX)}$, $T_A = 25^\circ\text{C}$	-	± 0.2	-	%
		$I_P = I_{P(MAX)}$, $T_A = 125^\circ\text{C}$	-	± 1.2	-	%
		$I_P = I_{P(MAX)}$, $T_A = -40^\circ\text{C}$	-	± 1.1	-	%
Offset Voltage Error	V_{OE}	$I_P = 0$ A, $T_A = 25^\circ\text{C}$	-	± 2	-	mV
		$I_P = 0$ A, $T_A = 125^\circ\text{C}$	-	± 12	-	mV
		$I_P = 0$ A, $T_A = -40^\circ\text{C}$	-	± 18	-	mV
LIFETIME DRIFT						
Total Error Including Lifetime Drift	$E_{TOT(DRIFT)}$	$I_P = I_{P(MAX)}$, $T_A = -40^\circ\text{C}$ to 125°C	-	± 1.9	-	% FS
Sensitivity Error Including Lifetime Drift	$E_{SENS(DRIFT)}$	$I_P = I_{P(MAX)}$, $T_A = -40^\circ\text{C}$ to 125°C	-	± 1.9	-	%
Offset Voltage Error Including Lifetime Drift	$V_{OE(DRIFT)}$	$I_P = 0$ A, $T_A = -40^\circ\text{C}$ to 125°C	-	± 30	-	mV

[1] Typical values are the mean ± 3 sigma of production distributions. These are formatted as mean ± 3 sigma.

[2] Lifetime drift characteristics are based on a statistical combination of production distributions and worst case distribution of parametric drift of individuals observed during AEC-Q100 qualification.

CT430-xSWF65DR: 0 to 65 A – PERFORMANCE CHARACTERISTICS: Valid for $V_{CC} = 4.75$ to 5.50 V, $C_{BYP} = 1.0$ μ F, and $T_A = -40^\circ\text{C}$ to 125°C , unless otherwise specified

Characteristics	Symbol	Test Conditions	Min.	Typ. ^[1]	Max.	Unit
Current Range	I_{RANGE}		0	–	65	A
Voltage Output Quiescent	V_{OQ}	$T_A = 25^\circ\text{C}$, $I_P = 0$ A	0.495	0.500	0.505	V
Sensitivity	S	$I_{RANGE(MIN)} < I_P < I_{RANGE(MAX)}$	–	61.5	–	mV/A
Bandwidth [1]	f_{BW}	Small Signal = –3 dB	–	1.0	–	MHz
Noise [1]	e_N	$T_A = 25^\circ\text{C}$, $f_{BW} = 100$ kHz	–	10.0	–	mA_{RMS}
OUT ACCURACY PERFORMANCE						
Total Output Error	E_{TOT}	I_P sweep from $I_{P(MIN)}$ to $I_{P(MAX)}$	–	–	± 1.0	% FS
Linearity Error	E_{LIN}	$I_P = I_{P(MAX)}$, $T_A = -40^\circ\text{C}$ to 125°C	–	± 0.1	–	% FS
Sensitivity Error	E_{SENS}	$I_P = I_{P(MAX)}$, $T_A = 25^\circ\text{C}$	–	± 0.3	–	%
		$I_P = I_{P(MAX)}$, $T_A = 125^\circ\text{C}$	–	± 1.4	–	%
		$I_P = I_{P(MAX)}$, $T_A = -40^\circ\text{C}$	–	± 1.5	–	%
Offset Voltage Error	V_{OE}	$I_P = 0$ A, $T_A = 25^\circ\text{C}$	–	± 1	–	mV
		$I_P = 0$ A, $T_A = 125^\circ\text{C}$	–	± 9	–	mV
		$I_P = 0$ A, $T_A = -40^\circ\text{C}$	–	± 12	–	mV
LIFETIME DRIFT						
Total Error Including Lifetime Drift	$E_{TOT(DRIFT)}$	$I_P = I_{P(MAX)}$, $T_A = -40^\circ\text{C}$ to 125°C	–	± 2.4	–	% FS
Sensitivity Error Including Lifetime Drift	$E_{SENS(DRIFT)}$	$I_P = I_{P(MAX)}$, $T_A = -40^\circ\text{C}$ to 125°C	–	± 2.1	–	%
Offset Voltage Error Including Lifetime Drift	$V_{OE(DRIFT)}$	$I_P = 0$ A, $T_A = -40^\circ\text{C}$ to 125°C	–	± 25	–	mV

[1] Typical values are the mean ± 3 sigma of production distributions. These are formatted as mean ± 3 sigma.

[2] Lifetime drift characteristics are based on a statistical combination of production distributions and worst case distribution of parametric drift of individuals observed during AEC-Q100 qualification.

CT430-xSWF65MR: ±65 A – PERFORMANCE CHARACTERISTICS: Valid for $V_{CC} = 4.75$ to 5.50 V, $C_{BYP} = 1.0$ μ F, and $T_A = -40^\circ\text{C}$ to 125°C , unless otherwise specified

Characteristics	Symbol	Test Conditions	Min.	Typ. ^[1]	Max.	Unit
Current Range	I_{RANGE}		-65	-	65	A
Voltage Output Quiescent	V_{OQ}	$T_A = 25^\circ\text{C}$, $I_P = 0$ A	2.495	2.500	2.505	V
Sensitivity	S	$I_{RANGE(MIN)} < I_P < I_{RANGE(MAX)}$	-	30.8	-	mV/A
Bandwidth [1]	f_{BW}	Small Signal = -3 dB	-	1.0	-	MHz
Noise [1]	e_N	$T_A = 25^\circ\text{C}$, $f_{BW} = 100$ kHz	-	13.5	-	mA_{RMS}
OUT ACCURACY PERFORMANCE						
Total Output Error	E_{TOT}	I_P sweep from $I_{P(MIN)}$ to $I_{P(MAX)}$	-	-	±1.0	% FS
Linearity Error	E_{LIN}	$I_P = I_{P(MAX)}$, $T_A = -40^\circ\text{C}$ to 125°C	-	±0.1	-	% FS
Sensitivity Error	E_{SENS}	$I_P = I_{P(MAX)}$, $T_A = 25^\circ\text{C}$	-	±0.3	-	%
		$I_P = I_{P(MAX)}$, $T_A = 125^\circ\text{C}$	-	±1.3	-	%
		$I_P = I_{P(MAX)}$, $T_A = -40^\circ\text{C}$	-	±1.3	-	%
Offset Voltage Error	V_{OE}	$I_P = 0$ A, $T_A = 25^\circ\text{C}$	-	±2	-	mV
		$I_P = 0$ A, $T_A = 125^\circ\text{C}$	-	±15	-	mV
		$I_P = 0$ A, $T_A = -40^\circ\text{C}$	-	±19	-	mV
LIFETIME DRIFT						
Total Error Including Lifetime Drift	$E_{TOT(DRIFT)}$	$I_P = I_{P(MAX)}$, $T_A = -40^\circ\text{C}$ to 125°C	-	±1.9	-	% FS
Sensitivity Error Including Lifetime Drift	$E_{SENS(DRIFT)}$	$I_P = I_{P(MAX)}$, $T_A = -40^\circ\text{C}$ to 125°C	-	±2.0	-	%
Offset Voltage Error Including Lifetime Drift	$V_{OE(DRIFT)}$	$I_P = 0$ A, $T_A = -40^\circ\text{C}$ to 125°C	-	±31	-	mV

[1] Typical values are the mean ±3 sigma of production distributions. These are formatted as mean ±3 sigma.

[2] Lifetime drift characteristics are based on a statistical combination of production distributions and worst case distribution of parametric drift of individuals observed during AEC-Q100 qualification.

FUNCTIONAL DESCRIPTION

Overview

The CT430 is a high accuracy contact current sensor with an integrated current-carrying conductor that handles up to 65 A. It has high sensitivity and a wide dynamic range with excellent accuracy (low total output error) across temperature. This current sensor supports eight current ranges:

- 0 to 20 A
- ±20 A
- 0 to 30 A
- ±30 A
- 0 to 50 A
- ±50 A
- 0 to 65 A
- ±65 A

When current is flowing through the current-carrying conductor, the XtremeSense TMR sensors inside the chip senses the field which in turn generates differential voltage signals that then goes through the Analog Front-End (AFE) to output a current measurement with less than ±1.0% full-scale total output error (E_{OUT}).

The chip is designed to enable a fast response time of 300 ns for the current measurement from the OUT pin as the bandwidth for the CT430 is 1.0 MHz. Even with a high bandwidth, the chip consumes a minimal amount of power.

Linear Output Current Measurement

The CT430 provides a continuous linear analog output voltage which represents the current measurement. The output voltage range of OUT is from 0.50 to 4.50 V with a V_{OQ} of 0.50 V and 2.50 V for unidirectional and bidirectional currents, respectively. Figure 17 illustrates the output voltage range of the OUT pin as a function of the measured current.

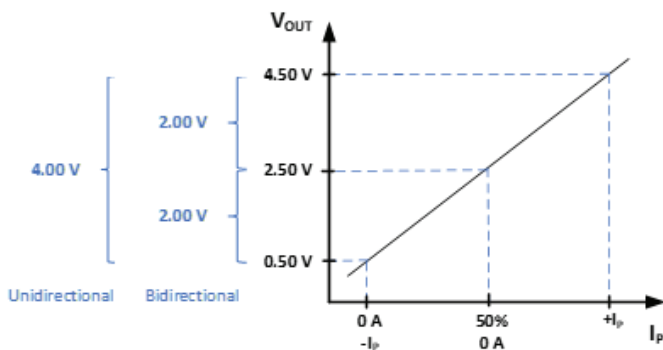

Figure 17: Linear Output Voltage Range (OUT) vs. Measured Current (IP)

Filter Function (FILTER)

The CT430 has a pin for the FILTER function which will enable it to improve the noise performance by changing the cutoff frequency. The bandwidth of the CT430 is 1.0 MHz; however, adding a capacitor to the FILTER pin—which will be in-series with an internal resistance of approximately 15 kΩ—will set the cutoff frequency to reduce noise.

Experimentally measured Bandwidth does not necessarily match the calculated bandwidth value obtained by using the equation $f_{BW} = 1/2\pi RC$ because of the parasitic capacitances due to PCB manufacturing and layout. This is further impacted by the small, picofarad level C_{FILTER} recommendations.

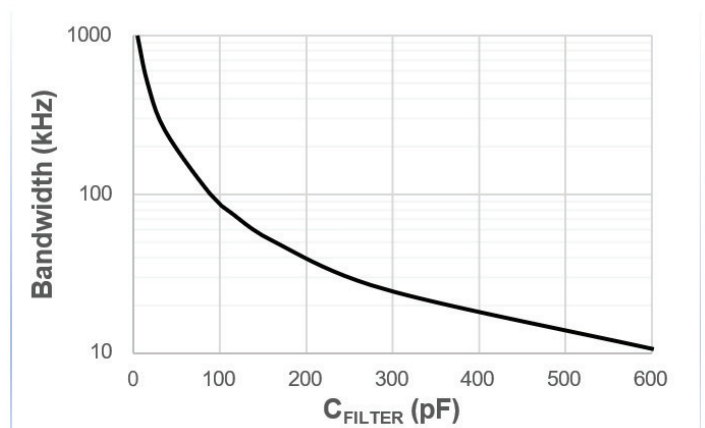

Figure 18: Experimental Bandwidth vs. C_{FILTER}

Voltage Reference Function (VREF)

The CT430 has a reference voltage (VREF) pin that may be used as an output voltage reference for AC or DC current measurements. The VREF pin should be connected to a buffer circuit.

If VREF is not used, then it should be left unconnected.

Sensitivity

Sensitivity (S) is a change in the CT430 output in response to a change in 1 A of current flowing through the current-carrying conductor. It is defined by the product of the magnetic circuit sensitivity (G/A, where 1.0 G = 0.1 mT) and the chip linear amplifier gain (mV/G). Therefore, the result of this gives a sensitivity unit of mV/A. The CT430 is factory-calibrated to optimize the sensitivity for the full scale of the device dynamic range.

Total Output Error

The Total Output Error (E_{OUT}) is the maximum deviation of the sensor output from the ideal sensor transfer curve over the full temperature range relative to the sensor full scale.

The Total Output Error is measured by performing a full-scale primary current (IP) sweep and measuring V_{OUT} at multiple points.

$$E_{OUT} = 100 * \frac{\max (V_{OUT_{IDEAL}}(I) - V_{OUT}(I))}{F.S.}$$

The Ideal Transfer Curve is calculated based on datasheet parameters as described below.

$$V_{OUT_{IDEAL}}(I_P) = V_{OQ} + S * I_P$$

E_{OUT} incorporates all sources of error and is a function of the sensed current (I_P) from the current sensor.

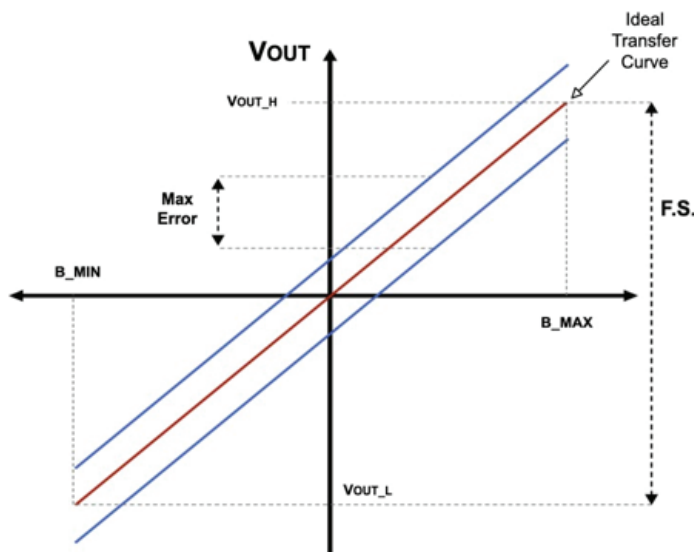

Figure 19: Total Output Error (E_{OUT}) vs. Sensed Current (I_P)

The CT430 achieves a total output error (E_{OUT}) that is less than $\pm 1.0\%$ of Full-Scale (FS) over supply voltage and temperature. It is designed with innovative and proprietary TMR sensors and circuit blocks to provide very accurate current measurements regardless of the operating conditions.

Sensitivity Error

The sensitivity error (E_{SENS}) is the sensitivity temperature drift error for unipolar or DC current. It is calculated using the equation below:

$$E_{SENS} = 100 * \left(\frac{S_{MEASURED}}{S} - 1 \right)$$

For bipolar or AC current, the E_{SENS} is calculated by dividing the equation by 2.

Power-On Time (t_{ON})

Power-On Time (t_{ON}) of 100 μs is the amount of time required by CT430 to start up, fully power the chip, and becoming fully operational from the moment the supply voltage is greater than the UVLO voltage. This time includes the ramp-up time and the settling time (within 10% of steady-state voltage under an applied magnetic field) after the power supply has reached the minimum V_{CC} .

Response Time ($t_{RESPONSE}$)

Response Time ($t_{RESPONSE}$) of 300 ns for the CT430 is the time interval between the following terms:

1. When the primary current signal reaches 90% of its final value,
2. When the chip reaches 90% of its output corresponding to the applied current.

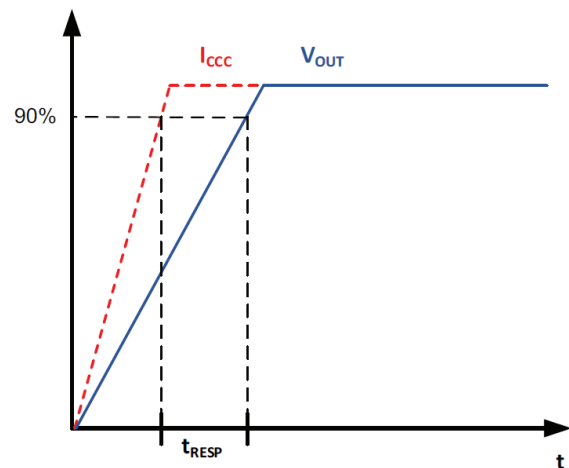

Figure 20: CT430 Response Time Curve

Rise Time (t_{RISE})

Rise Time (t_{RISE}) is the time interval of when it reaches 10% and 90% of the full-scale output voltage. The t_{RISE} of the CT430 is 200 ns.

Propagation Delay (t_{DELAY})

Propagation Delay (t_{DELAY}) is the time difference between these two events:

1. When the primary current reaches 20% of its final value
2. When the chip reaches 20% of its output corresponding to the applied current.

The CT430 has a propagation delay of 250 ns.

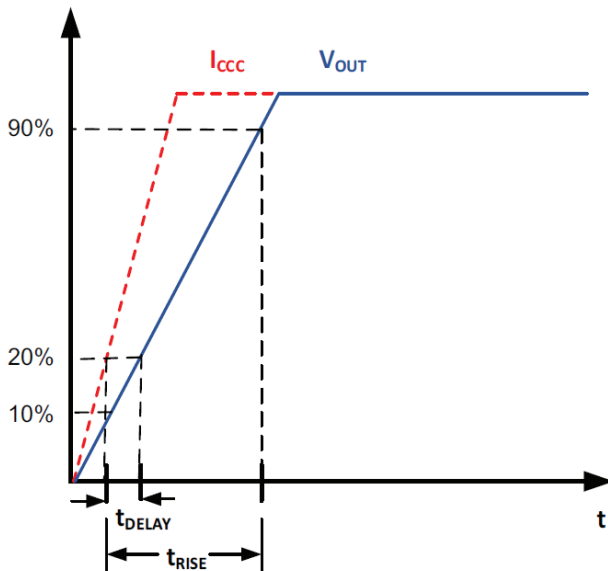

Figure 21: CT430 Propagation Delay and Rise Time Curve

Overcurrent Detection (OCD)

The Overcurrent Detection (OCD) circuitry detects measured current values that are 110% above the maximum current range value of the CT430 for the unipolar (DC current) variant. For the bipolar (AC current) variant of the CT430 it is greater than $\pm 110\%$ of the maximum current range. This will generate a fault signal via the Fault# Interrupt (\overline{FLT}) pin (low) to the host system's microcontroller. Once the measured current falls to 90% of the maximum current range for the DC current variant or $\pm 90\%$ for the AC current version then the fault will be cleared, and the \overline{FLT} pin will go high.

Undervoltage Lockout (UVLO)

The Undervoltage Lockout protection circuitry of the CT430 is activated when the supply voltage (V_{CC}) falls below 2.45 V. The CT430 remains in a low quiescent state until V_{CC} rises above the UVLO threshold (2.50 V). In this condition where V_{CC} is less than 2.45 V and UVLO is triggered, the output from the CT430 is not valid, and the \overline{FLT} pin will go low. Once V_{CC} rises above 2.50 V then the UVLO is cleared, and the \overline{FLT} pin will be high.

Fault# Interrupt (\overline{FLT})

The CT430 generates an active LOW digital fault signal via the \overline{FLT} pin to interrupt the microcontroller to indicate a fault event has been triggered. It is an open drain output and requires a pull-up resistor with a value of 100 k Ω tied to V_{CC} and a 1.0 nF capacitor is connected to ground. A fault signal will interrupt the host system for these events:

- OCD
- UVLO

The \overline{FLT} signal will be asserted low whenever one of the above fault events occur. In the case of an UVLO event, the \overline{FLT} pin will stay low until the fault is cleared and then go high.

If the \overline{FLT} is not used, then a 1.0 nF capacitor must be connected from the pin to ground.

Immunity to Common Mode Fields

The CT430 is housed in custom plastic package that uses a U-shaped leadframe to reduce the common mode fields generated by external stray magnetic fields. With the U-shaped leadframe, the stray fields cancel one another thus reducing electro-magnetic interference (EMI). The CT430 is able to achieve -54 dB of Common Mode Rejection Ratio (CMFRR). Also, good PCB layout of the CT430 will optimize performance and reduce EMI. See the Applications Information section in this datasheet for recommendations on PCB layout.

Creepage and Clearance

Two important terms as it relates to isolation provided by the package are: creepage and clearance. Creepage is defined as the shortest distance across the surface of the package from one side the leads to the other side of the leads. The definition for clearance is the shortest distance between the leads of opposite side through the air.

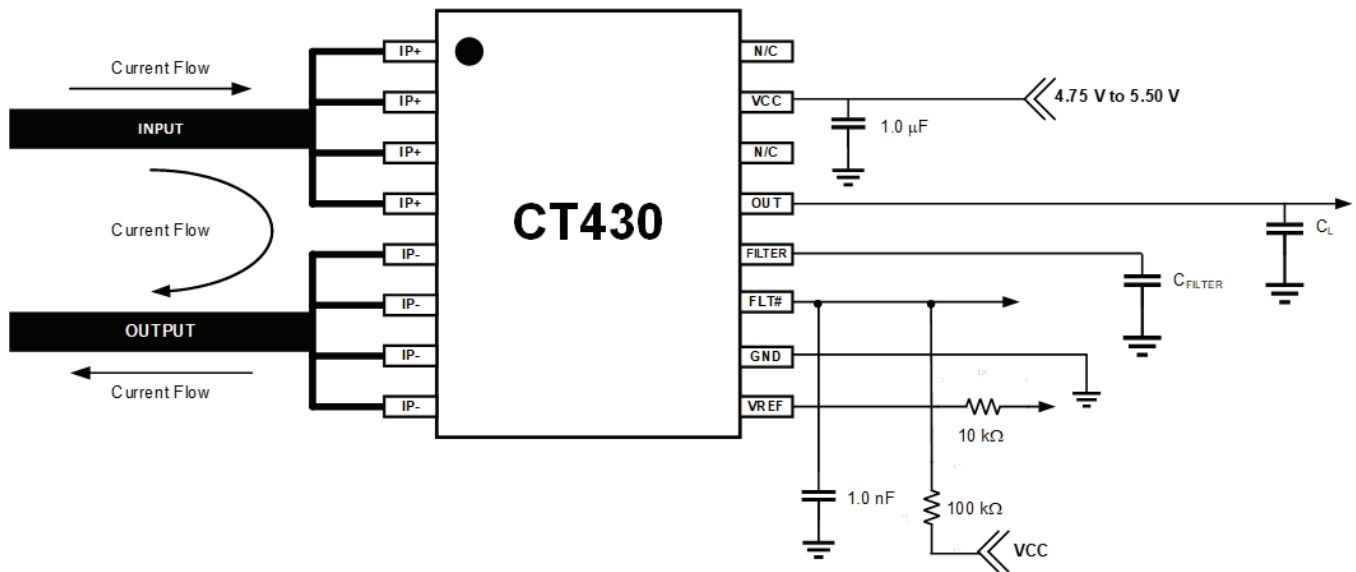

Figure 22: CT430 Application Block Diagram

Application

The CT430 is an integrated contact current sensor that can be used in many applications from measuring current in power supplies to motor control to overcurrent fault protection. It is a plug-and-play solution in that no calibration is required, and it outputs to a microcontroller a simple linear analog output voltage which corresponds to a current measurement value. A second output called $\overline{\text{FLT}} \#$ alerts the host system to any fault event that may occur in the CT430. Figure 22 is an application diagram of how CT430 would be implemented in a system. The third output is the VREF which provides the output reference voltage of the CT430.

The device is designed to support an operating voltage range of 4.75 V to 5.50 V, but it is ideal to use a 5.0 V power supply where the output tolerance is less than $\pm 5\%$.

Bypass Capacitor

A single 1.0 μF capacitor is needed for the VCC pin to reduce the noise from the power supply and other circuits. This capacitor should be placed as close as possible to the CT430 to minimize inductance and resistance between the two devices.

Filter Capacitor

A capacitor may be added to the FILTER pin of the CT430 if there is a requirement to improve the noise performance. The capacitor will be connected to an internal resistor of 15 k Ω inside

the chip to form an R-C filter. This R-C filter produces a cutoff frequency that will reduce the noise over this lower bandwidth.

If the FILTER pin is not used, then it should not be connected (no connect).

$\overline{\text{FLT}} \#$ and VREF Resistors and Capacitors

For the CT430, the $\overline{\text{FLT}} \#$ pin is an open drain output. It requires a pull-up resistor value of 100 k Ω to be connected from the pin to VCC and also a 1.0 nF capacitor to be connected from the pin to ground.

In designs where the VREF pin is used, a 10 k Ω resistor must be connected as close to the pin as possible in series with a load.

If the VREF pin is not needed in the application, then this pin should not be connected and be left floating.

Also, if the $\overline{\text{FLT}} \#$ pin function is not required in the application, then a 1.0 nF capacitor must be connected from this pin to ground.

Recommended PCB Layout

Since the CT430 can measure up to 65 A of current, special care must be taken in the printed circuit board (PCB) layout of the CT430 and the surrounding circuitry. It is recommended that the CCC pins be connected to as much copper area as possible. For up to 30 A of current, 2 oz (or heavier) of copper can be used for the PCB traces. It is also recommended that 4 oz. or heavier cop-

per be used for PCB traces when the CT430 is used to measure 50 A and 65 A of current. Additional layers of the PCB should also be used to carry current and be connected using the arrangement of vias. Figure 23 and Figure 24 show the recommended the PCB layout for the 20 A, 30 A, 50 A, and 65 A variants of the CT430. Note that the traces connected to the IP+ and IP- pins of the CT430 are very wide with multiple vias such that it can handle the high current.

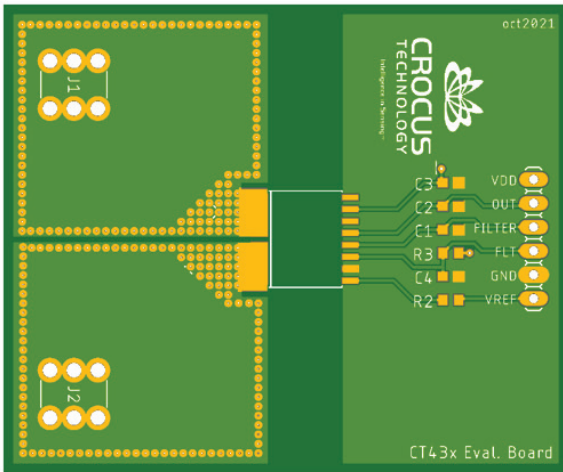

Figure 23: Recommended PCB Layout (Top Layer) for the 20 A to 65 A variants of the CT430

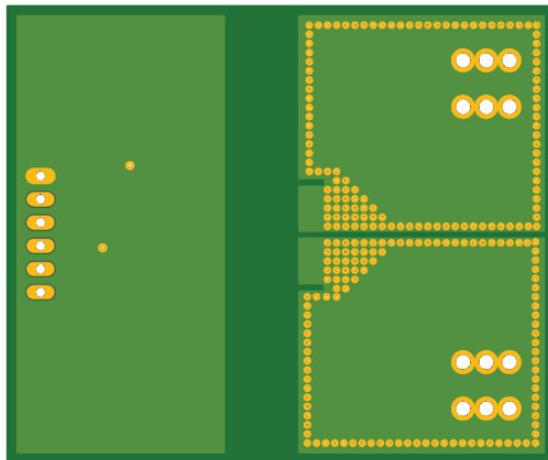

Figure 24: Recommended PCB Layout (Bottom Layer) for the 20 A to 65 A variants of the CT430

Fuse Time vs. Current

Since the CT430 is a contact current sensor, it dissipates heat as current is conducted through its leadframe, this limits the current it can measure which is 65 A. The CT430 leadframe has ~0.5 mΩ resistance which results in very low power dissipation during normal operation.

However, when the current surges above the rated nominal values of the CT430 due to short circuit or transient current spikes for a specific duration of time, the leadframe will be permanently damaged.

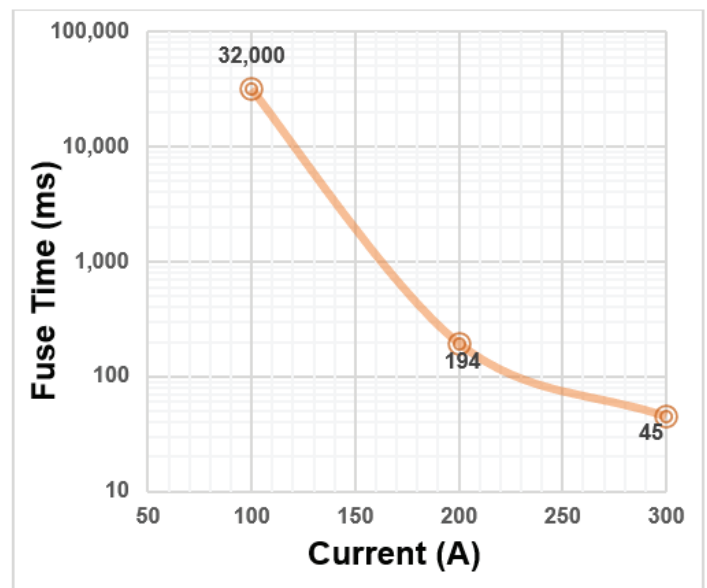

Figure 25: CT430 Fuse Time vs. Current

Figure 25 illustrates the CT430 fuse time for 100 A, 200 A, and 300 A current levels. The CT430 tolerates 100 A for 32 seconds while, at 200 A and 300 A, the fuse times are 194 ms and 45 ms, respectively.

Thermal Rise vs. Primary Current

Self-heating due to the flow of current should be considered during the design of any current sensing system. The sensor, printed circuit board (PCB), and contacts to the PCB will generate heat as current moves through the system.

The thermal response is highly dependent on PCB layout, copper thickness, cooling techniques, and the profile of the injected current.

The current profile includes peak current, current on-time, and duty cycle. While the data presented in this section was collected with direct current (DC), these numbers may be used to approximate thermal response for both AC signals and current pulses.

The plot in Figure 26 shows the measured rise in steady-state die temperature of the current sensor versus continuous current at an ambient temperature, T_A , of 25 °C. The thermal offset curves may be directly applied to other values of T_A .

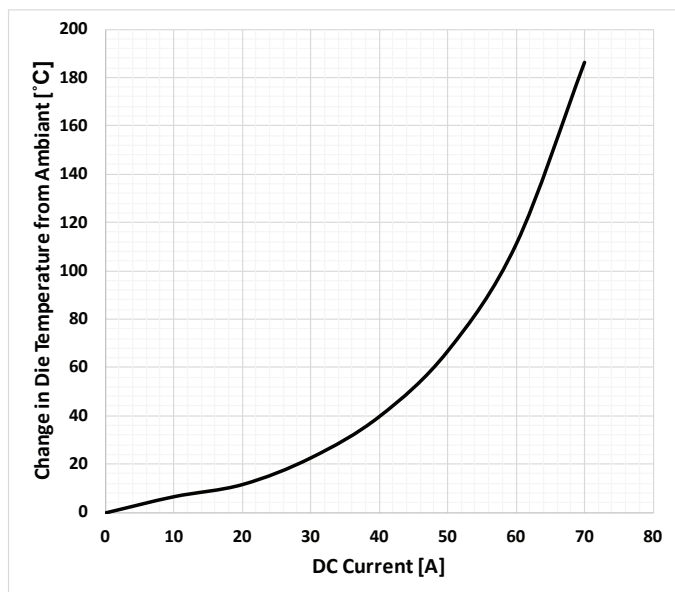

Figure 26: Self Heating in the LA Package Due to Current Flow

PACKAGE OUTLINE DRAWING

For Reference Only – Not for Tooling Use

Dimensions in millimeters – NOT TO SCALE

Dimensions exclusive of mold flash, gate burs, and dambar protrusions

Exact case and lead configuration at supplier discretion within limits shown

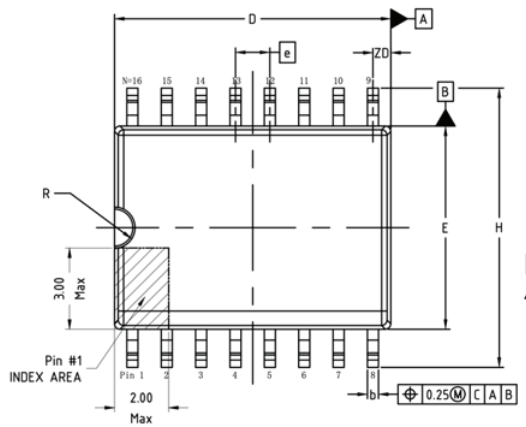

TOP VIEW

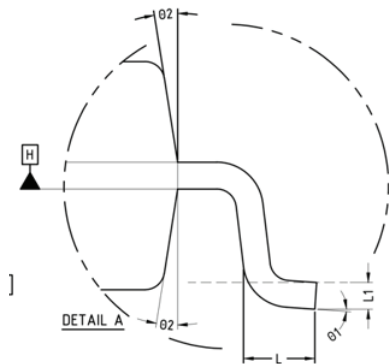
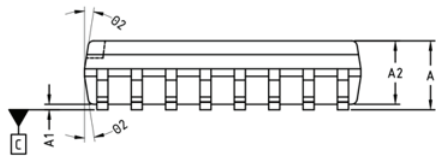
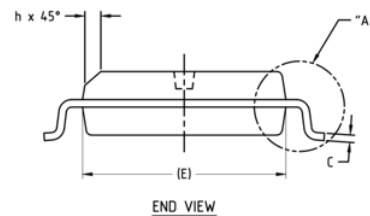

Table 1: CT430 SOICW-16 Package Dimensions

Symbol	Dimensions in Millimeters (mm)		
	Min.	Typ.	Max.
A	2.44	2.54	2.64
A1	0.10	0.20	0.30
A2	2.24	2.34	2.44
b	0.36	0.41	0.46
C	0.23	–	0.32
D	10.11	10.21	10.31
E	7.40	7.50	7.60
e	1.27 BSC		
H	10.11	10.31	10.51
h	0.31	0.51	0.71
L	0.51	0.76	1.01
L1	0.25 BSC		
R	0.76 REF		
Ø1	0.25 BSC	0.25 BSC	0.25 BSC
Ø2	0.76 REF	0.76 REF	0.76 REF
ZD	0.66 REF		
N	16		



END VIEW

Figure 27: SOICW-16 Package Drawing and Dimensions

TAPE AND REEL POCKET DRAWING AND DIMENSIONS

For Reference Only – Not for Tooling Use

Dimensions in millimeters – NOT TO SCALE

Dimensions exclusive of mold flash, gate burs, and dambar protrusions
Exact case and lead configuration at supplier discretion within limits shown

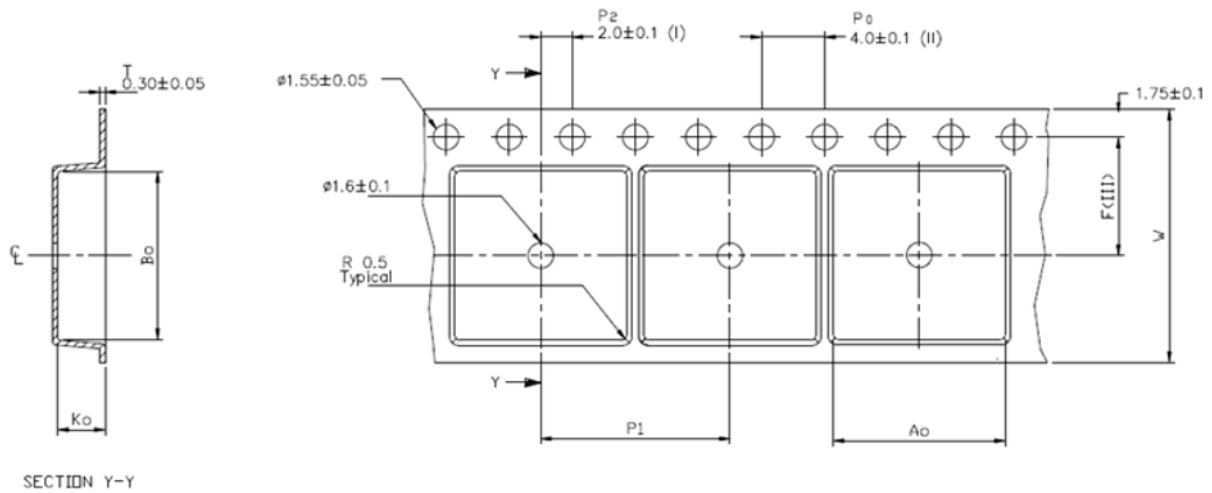

Ao	10.90 +/- 0.1
Bo	10.70 +/- 0.1
Ko	3.00 +/- 0.1
F	7.50 +/- 0.1
P1	12.00 +/- 0.1
W	16.00 +/- 0.3

- (I) Measured from centreline of sprocket hole to centreline of pocket.
 - (II) Cumulative tolerance of 10 sprocket holes is ± 0.20 .
 - (III) Measured from centreline of sprocket hole to centreline of pocket.
 - (IV) Other material available.
 - (V) Typical SR of form tape Max 10⁸ OHM/SQ
- ALL DIMENSIONS IN MILLIMETRES UNLESS OTHERWISE STATED.

Figure 28: Tape and Pocket Drawing for SOICW-16 Package

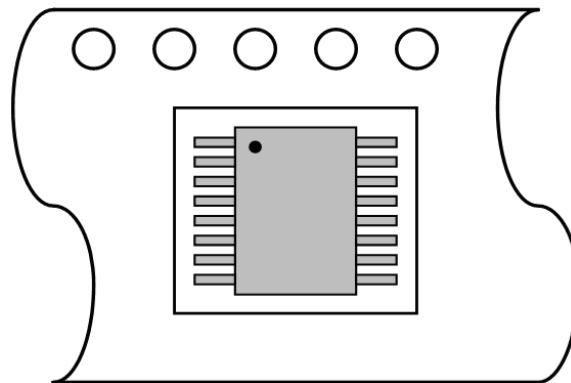

Figure 29: SOICW-16 Orientation in Tape Pocket

PACKAGE INFORMATION

Table 2: CT430 Package Information

Part Number	Package Type	# of Leads	Package Quantity	Lead Finish	MSL Rating [2]	Operating Temperature (°C) [3]	Device Marking [4]
CT430-HSWF20DR	SOICW	16	1000	Sn	3	-40 to 125	CT430 SWF20DR YYWWLL
CT430-ASWF20DR	SOICW	16	1000	Sn	3	-40 to 125	CT430A SWF20DR YYWWLL
CT430-HSWF20MR	SOICW	16	1000	Sn	3	-40 to 125	CT430 SWF20MR YYWWLL
CT430-ASWF20MR	SOICW	16	1000	Sn	3	-40 to 125	CT430A SWF20MR YYWWLL
CT430-HSWF30DR	SOICW	16	1000	Sn	3	-40 to 125	CT430 SWF30DR YYWWLL
CT430-ASWF30DR	SOICW	16	1000	Sn	3	-40 to 125	CT430A SWF30DR YYWWLL
CT430-HSWF30MR	SOICW	16	1000	Sn	3	-40 to 125	CT430 SWF30MR YYWWLL
CT430-ASWF30MR	SOICW	16	1000	Sn	3	-40 to 125	CT430A SWF30MR YYWWLL
CT430-HSWF50DR	SOICW	16	1000	Sn	3	-40 to 125	CT430 SWF50DR YYWWLL
CT430-ASWF50DR	SOICW	16	1000	Sn	3	-40 to 125	CT430A SWF50DR YYWWLL
CT430-HSWF50MR	SOICW	16	1000	Sn	3	-40 to 125	CT430 SWF50MR YYWWLL
CT430-ASWF50MR	SOICW	16	1000	Sn	3	-40 to 125	CT430A SWF50MR YYWWLL
CT430-HSWF65DR	SOICW	16	1000	Sn	3	-40 to 125	CT430 SWF65DR YYWWLL
CT430-ASWF65DR	SOICW	16	1000	Sn	3	-40 to 125	CT430A SWF65DR YYWWLL
CT430-HSWF65MR	SOICW	16	1000	Sn	3	-40 to 125	CT430 SWF65MR YYWWLL
CT430-ASWF65MR	SOICW	16	1000	Sn	3	-40 to 125	CT430A SWF65MR YYWWLL

[1] RoHS is defined as semiconductor products that are compliant to the current EU RoHS requirements. It also will meet the requirement that RoHS substances do not exceed 0.1% by weight in homogeneous materials. Green is defined as the content of chlorine (Cl), bromine (Br), and antimony trioxide based flame retardants satisfy JS709B low halogen requirements of $\leq 1,000$ ppm.

[2] MSL Rating = Moisture Sensitivity Level Rating as defined by JEDEC standard classifications.

[3] Package will withstand ambient temperature range of -40°C to 125°C and storage temperature range of -65°C to 150°C .

[4] Device Marking for CT430 is defined as CT430 SWFxxZR YYWWLL where the first 2 lines = part number, YY = year, WW = work week, and LL = lot code.

DEVICE MARKING

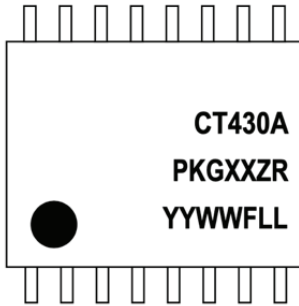
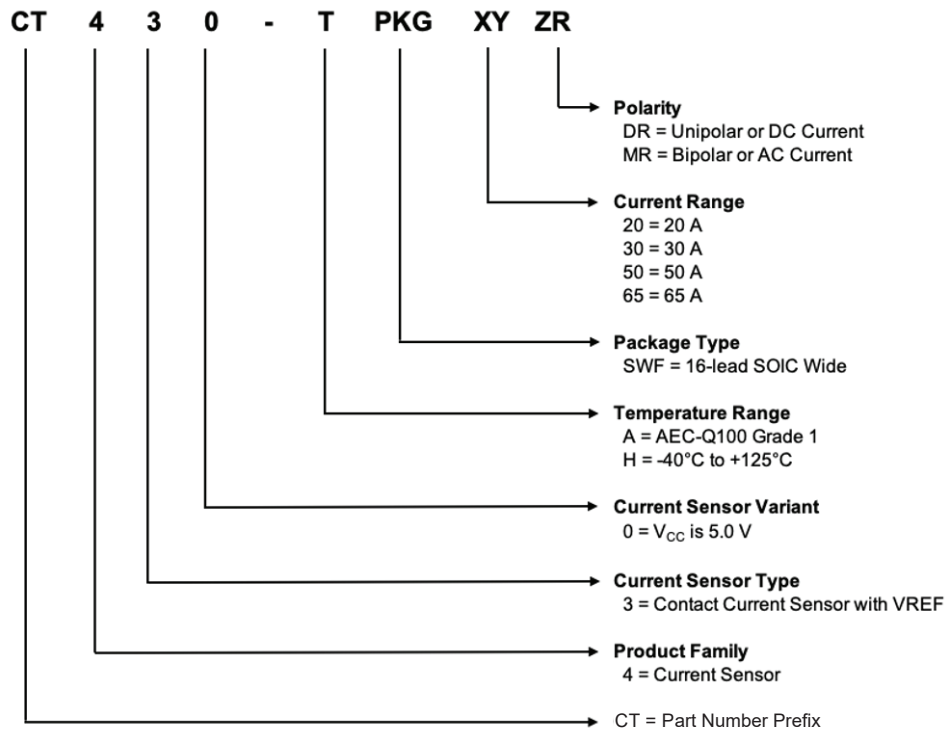

Table 3: CT430 Device Marking Definition for 16-lead SOICW Package

Row No.	Code	Definition
3	•	Pin 1 Indicator
1	CT430	Allegro Part Number
1	A	AEC-Q100 Qualified
2	PKG	Package Type
2	XX	Maximum Current Rating
2	ZR	Polarity
3	YY	Calendar Year
3	WW	Work Week
3	LL	Lot Code

Figure 30: CT430 Device Marking for 16-lead Package

PART ORDERING NUMBER LEGEND



Revision History

Number	Date	Description
3	November 2, 2023	Document rebranded and minor editorial updates
4	April 16, 2024	Updated Description and Features and Benefits (page 1); updated Table of Contents (page 2); removed Thermal Characteristics table (page 3); removed IEC 61000 reference (pages 1 and 3); updated Isolation Ratings table (page 4); added Thermal Rise vs. Primary Current section (page 25); removed performance graph pages.
5	April 29, 2024	Updated Primary Conductor Resistance value (page 6).
6	June 4, 2024	Added notes to package drawings (pages 26 and 27)
7	March 27, 2025	Updated product status to not for new design (cover sheet) and removed reference to evaluation board from table of contents (page 2)

Copyright 2025, Allegro MicroSystems.

Allegro MicroSystems reserves the right to make, from time to time, such departures from the detail specifications as may be required to permit improvements in the performance, reliability, or manufacturability of its products. Before placing an order, the user is cautioned to verify that the information being relied upon is current.

Allegro's products are not to be used in any devices or systems, including but not limited to life support devices or systems, in which a failure of Allegro's product can reasonably be expected to cause bodily harm.

The information included herein is believed to be accurate and reliable. However, Allegro MicroSystems assumes no responsibility for its use; nor for any infringement of patents or other rights of third parties which may result from its use.



Copies of this document are considered uncontrolled documents.

For the latest version of this document, visit our website:

www.allegromicro.com

Looking for pricing, stock, or lifecycle information?

Click below to explore more details on WIN SOURCE:

-  [View CT430-HSWF30MR on WIN SOURCE](#)
-  [Allegro MicroSystems, LLC Information](#)

Optimize Your Supply Chain with WIN SOURCE Solutions

-  Global Sourcing Solution
-  Obsolete Management
-  Cost Control Management
-  Shortage Management
-  Alternative Solution
-  Excess Inventory Management