

BFR380F

Low profile linear silicon NPN RF bipolar transistor



Product description

The BFR380F is a low noise device based on Si that is part of Infineon's established third generation RF bipolar transistor family. Its high current and low noise characteristics make the device suitable for a broad range of applications as high as 3.5 GHz. It remains cost competitive without compromising on ease of use.



Feature list

- Minimum noise figure $NF_{min} = 1.1$ dB at 1.8 GHz, 3 V, 8 mA
- High gain $G_{ma} = 13.5$ dB at 1.8 GHz, 3 V, 40 mA
- $OIP_3 = 29$ dBm at 1.8 GHz, 3 V, 40 mA

Product validation

Qualified for industrial applications according to the relevant tests of JEDEC47/20/22.

Potential applications

- Low noise amplifiers (LNAs) for DVB-T/H
- LNAs for TV white space application
- Low noise, high linearity amplifiers for sub-1 GHz ISM band applications

Device information

Table 1 Part information

| Product name / Ordering code | Package | Pin configuration | | | Marking | Pieces / Reel |
|------------------------------|----------|-------------------|-------|-------|---------|---------------|
| BFR380F / BFR380FH6327XTSA1 | TSFP-3-1 | 1 = B | 2 = E | 3 = C | FCs | 3000 |

Attention: ESD (Electrostatic discharge) sensitive device, observe handling precautions

Table of contents

Table of contents

| | | |
|----------|--|----|
| | Product description | 1 |
| | Feature list | 1 |
| | Product validation | 1 |
| | Potential applications | 1 |
| | Device information | 1 |
| | Table of contents | 2 |
| 1 | Absolute maximum ratings | 3 |
| 2 | Thermal characteristics | 4 |
| 3 | Electrical characteristics | 6 |
| 3.1 | DC characteristics | 6 |
| 3.2 | General AC characteristics | 6 |
| 3.3 | Frequency dependent AC characteristics | 7 |
| 3.4 | Characteristic AC diagrams | 8 |
| 4 | Package information TSFP-3-1 | 15 |
| | Revision history | 16 |
| | Disclaimer | 17 |

Absolute maximum ratings

1 Absolute maximum ratings

Table 2 Absolute maximum ratings at $T_A = 25\text{ °C}$ (unless otherwise specified)

| Parameter | Symbol | Values | | Unit | Note or test condition |
|---------------------------------------|-----------|--------|------|------|-------------------------|
| | | Min. | Max. | | |
| Collector emitter voltage | V_{CEO} | - | 6 | V | Open base |
| Collector emitter voltage | V_{CES} | | 15 | | E-B short circuited |
| Collector base voltage | V_{CBO} | | 15 | | Open emitter |
| Emitter base voltage | V_{EBO} | | 2 | | Open collector |
| Base current | I_B | | 14 | mA | - |
| Collector current | I_C | | 80 | | |
| Total power dissipation ¹⁾ | P_{tot} | | 380 | mW | $T_S \leq 95\text{ °C}$ |
| Junction temperature | T_J | | 150 | °C | - |
| Storage temperature | T_{Stg} | -55 | | | |

Attention: *Stresses above the max. values listed here may cause permanent damage to the device. Exposure to absolute maximum rating conditions for extended periods may affect device reliability. Exceeding only one of these values may cause irreversible damage to the integrated circuit.*

¹ T_S is the soldering point temperature. T_S is measured on the emitter lead at the soldering point of the PCB.

Thermal characteristics

2 Thermal characteristics

Table 3 Thermal resistance

| Parameter | Symbol | Values | | | Unit | Note or test condition |
|----------------------------|------------|--------|------|------|------|------------------------|
| | | Min. | Typ. | Max. | | |
| Junction - soldering point | R_{thJS} | - | 145 | - | K/W | - |

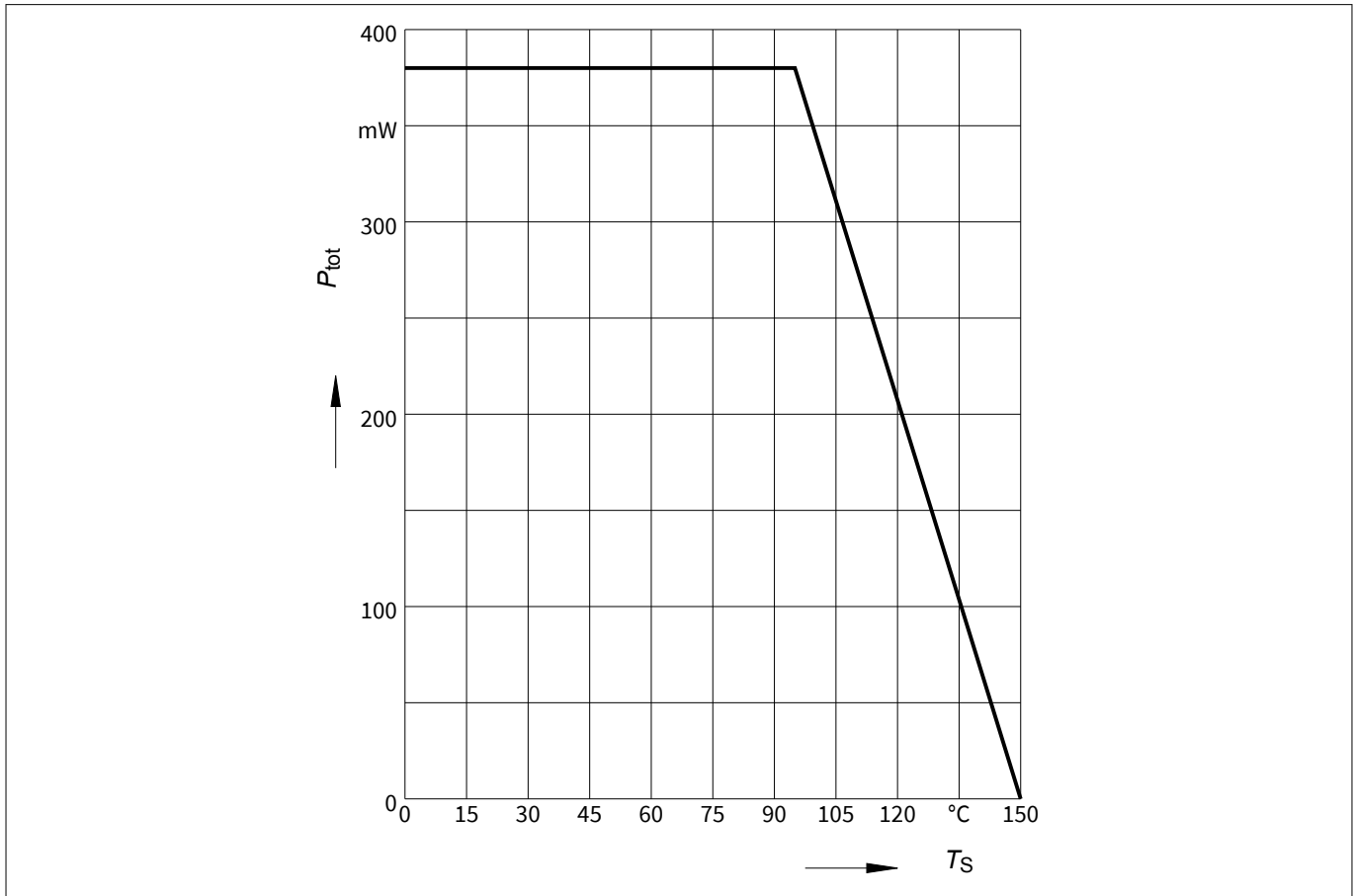

Figure 1 Total power dissipation $P_{tot} = f(T_s)$

Thermal characteristics

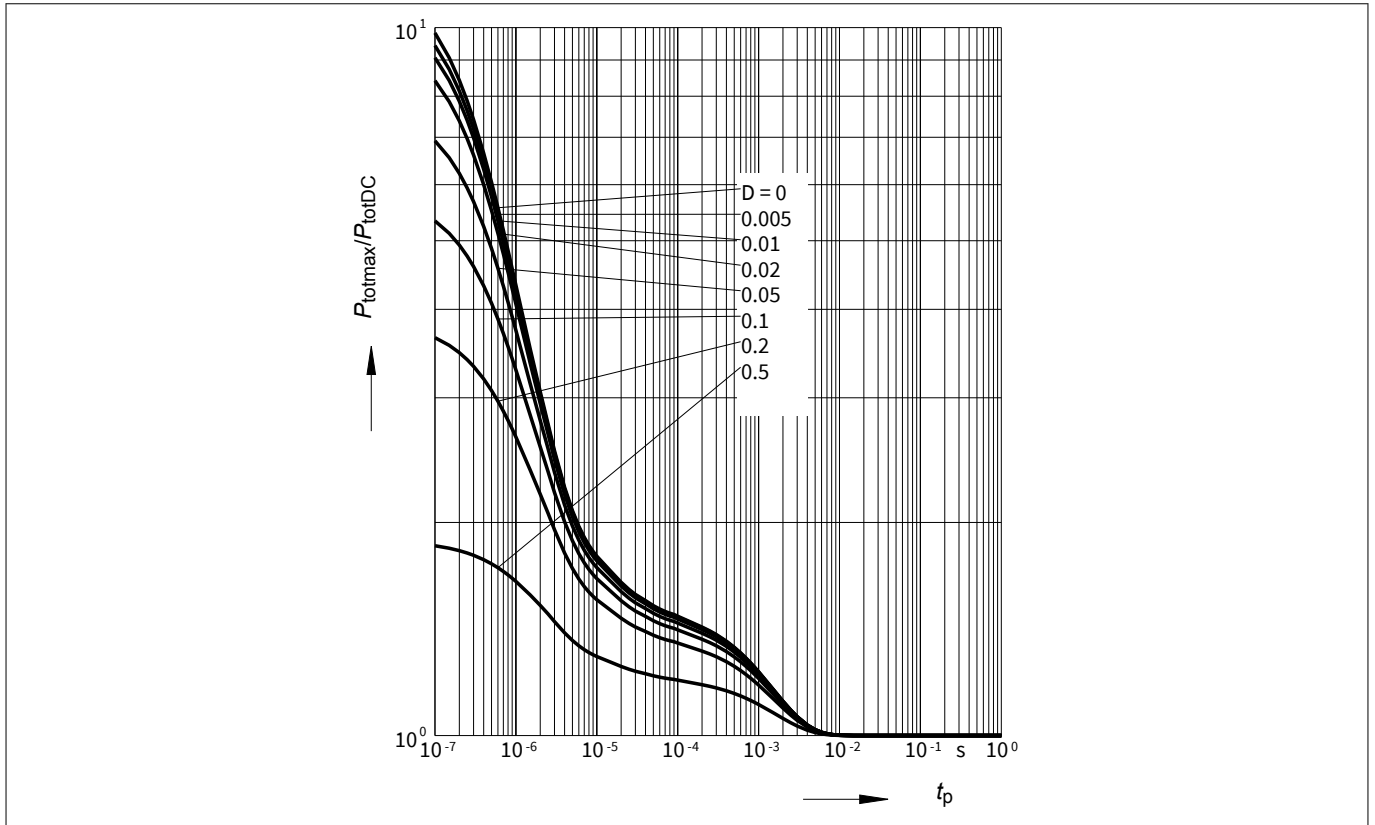

Figure 2 Permissible Pulse Load $P_{tot,max} / P_{tot,DC} = f(t_p)$

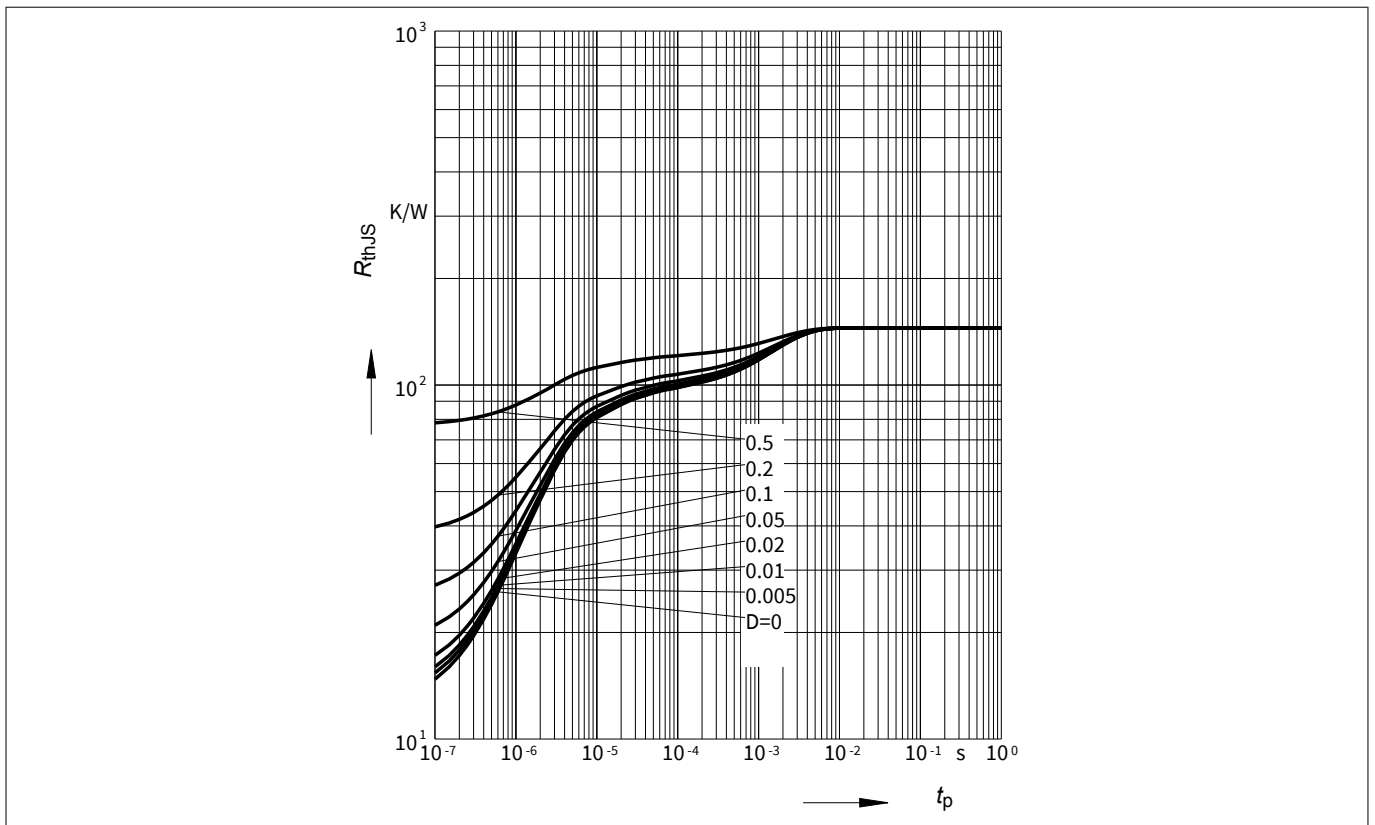

Figure 3 Permissible Pulse Load $R_{th,J,S} = f(t_p)$

Electrical characteristics

3 Electrical characteristics

3.1 DC characteristics

Table 4 DC characteristics at $T_A = 25\text{ }^\circ\text{C}$

| Parameter | Symbol | Values | | | Unit | Note or test condition |
|-------------------------------------|---------------|--------|------|--------------------|------|---|
| | | Min. | Typ. | Max. | | |
| Collector emitter breakdown voltage | $V_{(BR)CEO}$ | 6 | 9 | – | V | $I_C = 1\text{ mA}$, $I_B = 0$, open base |
| Collector emitter leakage current | I_{CES} | – | 1 | 30 ²⁾ | nA | $V_{CE} = 5\text{ V}$, $V_{BE} = 0$, E-B short circuited |
| | | | – | 1000 ²⁾ | | $V_{CE} = 15\text{ V}$, $V_{BE} = 0$, E-B short circuited |
| Collector base leakage current | I_{CBO} | | | 30 ²⁾ | | $V_{CB} = 5\text{ V}$, $I_E = 0$, open emitter |
| Emitter base leakage current | I_{EBO} | | 1 | 500 ²⁾ | | $V_{EB} = 1\text{ V}$, $I_C = 0$, open collector |
| DC current gain | h_{FE} | 90 | 120 | 160 | | $V_{CE} = 3\text{ V}$, $I_C = 40\text{ mA}$, pulse measured |

3.2 General AC characteristics

Table 5 General AC characteristics at $T_A = 25\text{ }^\circ\text{C}$

| Parameter | Symbol | Values | | | Unit | Note or test condition |
|-------------------------------|----------|--------|------|------|------|--|
| | | Min. | Typ. | Max. | | |
| Transition frequency | f_T | 11 | 14 | – | GHz | $V_{CE} = 3\text{ V}$, $I_C = 40\text{ mA}$, $f = 1\text{ GHz}$ |
| Collector base capacitance | C_{CB} | – | 0.5 | 0.7 | pF | $V_{CB} = 5\text{ V}$, $V_{BE} = 0$, $f = 1\text{ MHz}$, emitter grounded |
| Collector emitter capacitance | C_{CE} | | 0.2 | – | | $V_{CE} = 5\text{ V}$, $V_{BE} = 0$, $f = 1\text{ MHz}$, base grounded |
| Emitter base capacitance | C_{EB} | | 1 | | | $V_{EB} = 0.5\text{ V}$, $V_{CB} = 0$, $f = 1\text{ MHz}$, collector grounded |

² Maximum values not limited by the device but by the short cycle time of the 100% test.

Electrical characteristics

3.3 Frequency dependent AC characteristics

Measurement setup is a test fixture with Bias-T's in a 50 Ω system, $T_A = 25\text{ }^\circ\text{C}$.

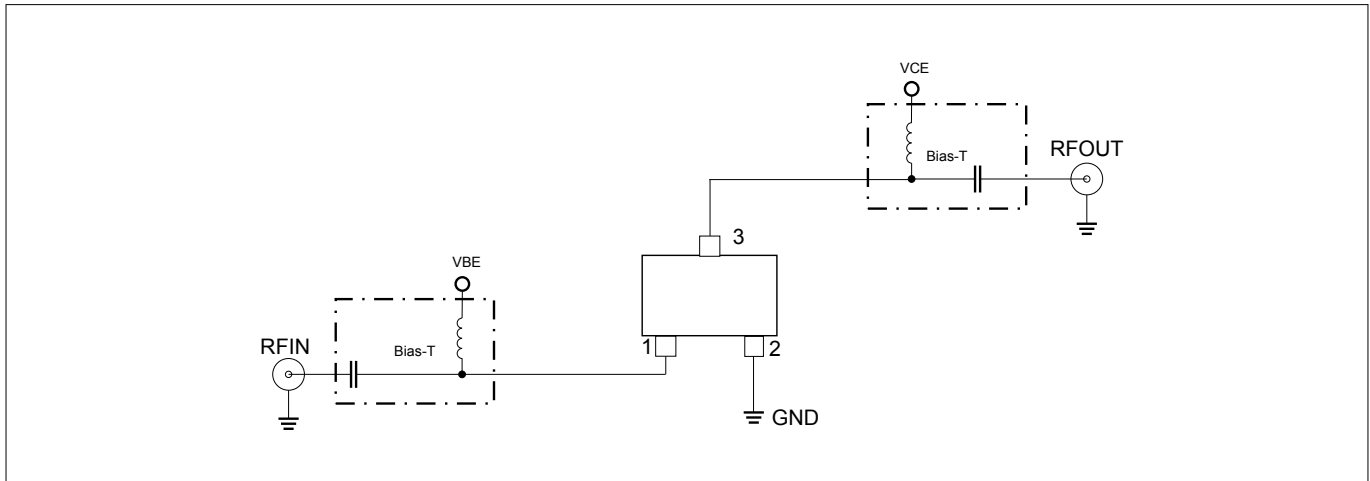

Figure 4 Testing circuit

Table 6 AC characteristics, $V_{CE} = 3\text{ V}$, $f = 1.8\text{ GHz}$

| Parameter | Symbol | Values | | | Unit | Note or test condition |
|---|--------------------------|--------|------------|------|------|--|
| | | Min. | Typ. | Max. | | |
| Power gain | | - | | - | dB | $I_C = 40\text{ mA}$ |
| <ul style="list-style-type: none"> Maximum power gain Transducer gain | G_{ms} $ S_{21} ^2$ | | 13.5 11 | | | |
| Noise figure | | | | | | |
| <ul style="list-style-type: none"> Minimum noise figure | NF_{min} | | 1.1 | | | $I_C = 8\text{ mA}$ |
| Linearity | | | | | dBm | $I_C = 40\text{ mA}$, $Z_S = Z_L = 50\text{ }\Omega$, |
| <ul style="list-style-type: none"> 3rd order intercept point at output | OIP_3 | | 29 | | | |
| <ul style="list-style-type: none"> 1 dB gain compression point at output | OP_{1dB} OP_{1dB} | | 17 19.5 | | | |

Table 7 AC characteristics, $V_{CE} = 3\text{ V}$, $f = 3\text{ GHz}$

| Parameter | Symbol | Values | | | Unit | Note or test condition |
|---|--------------------------|--------|----------|------|------|------------------------|
| | | Min. | Typ. | Max. | | |
| Power gain | | - | | - | dB | $I_C = 40\text{ mA}$ |
| <ul style="list-style-type: none"> Maximum power gain Transducer gain | G_{ms} $ S_{21} ^2$ | | 9.5 7 | | | |
| Noise figure | | | | | | |
| <ul style="list-style-type: none"> Minimum noise figure | NF_{min} | | 1.6 | | | $I_C = 8\text{ mA}$ |

Note: $G_{ms} = |S_{21}/S_{12}|$ for $k < 1$; $G_{ma} = |S_{21}/S_{12}|(k-(k^2-1)^{1/2})$ for $k > 1$. In order to get the NF_{min} values stated in this chapter, the test fixture losses have been subtracted from all measured results. OIP_3 value depends on termination of all intermodulation frequency components. Termination used for this measurement is 50 Ω from 0.1 MHz to 6 GHz.

Electrical characteristics

3.4 Characteristic AC diagrams

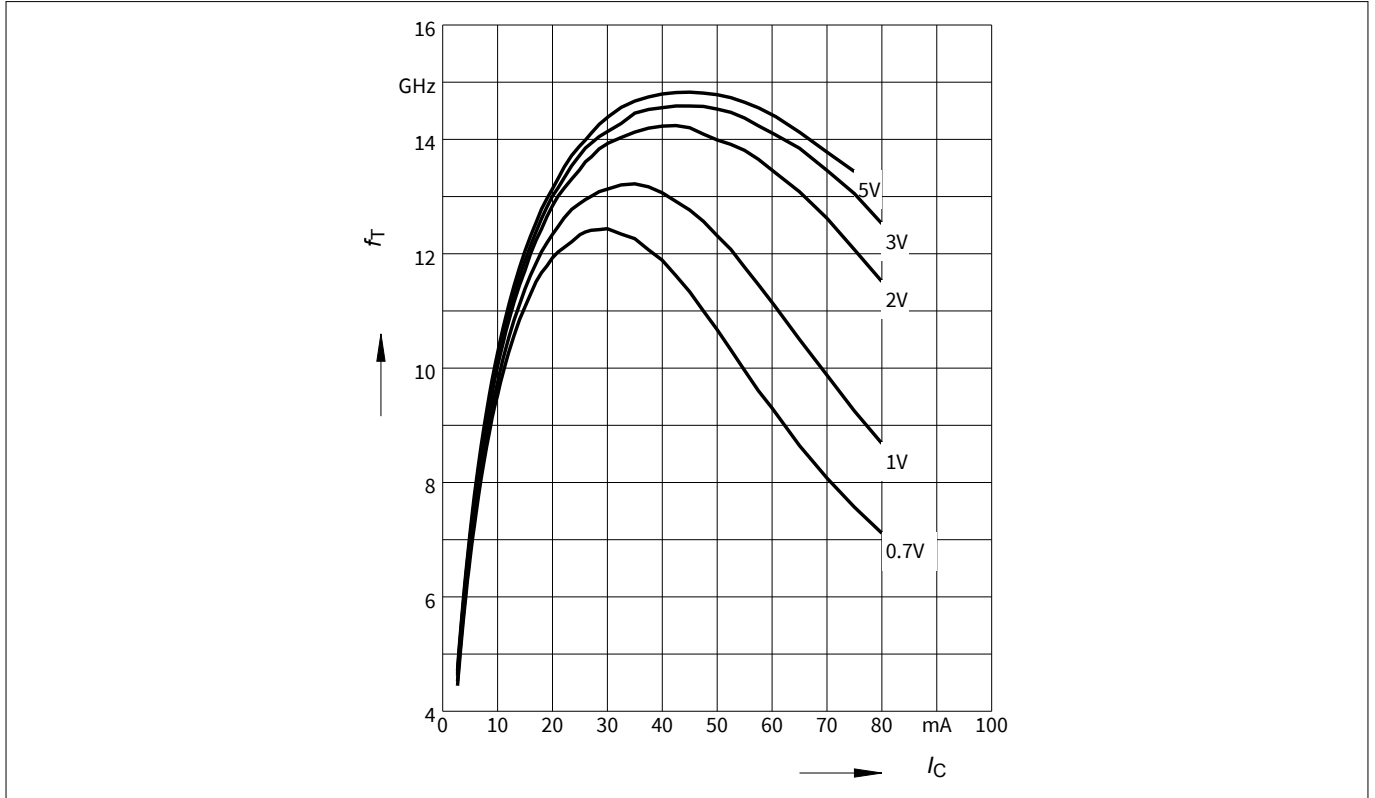

Figure 5 Transition frequency $f_T = f(I_C)$, $f = 1 \text{ GHz}$, $V_{CE} = \text{parameter}$

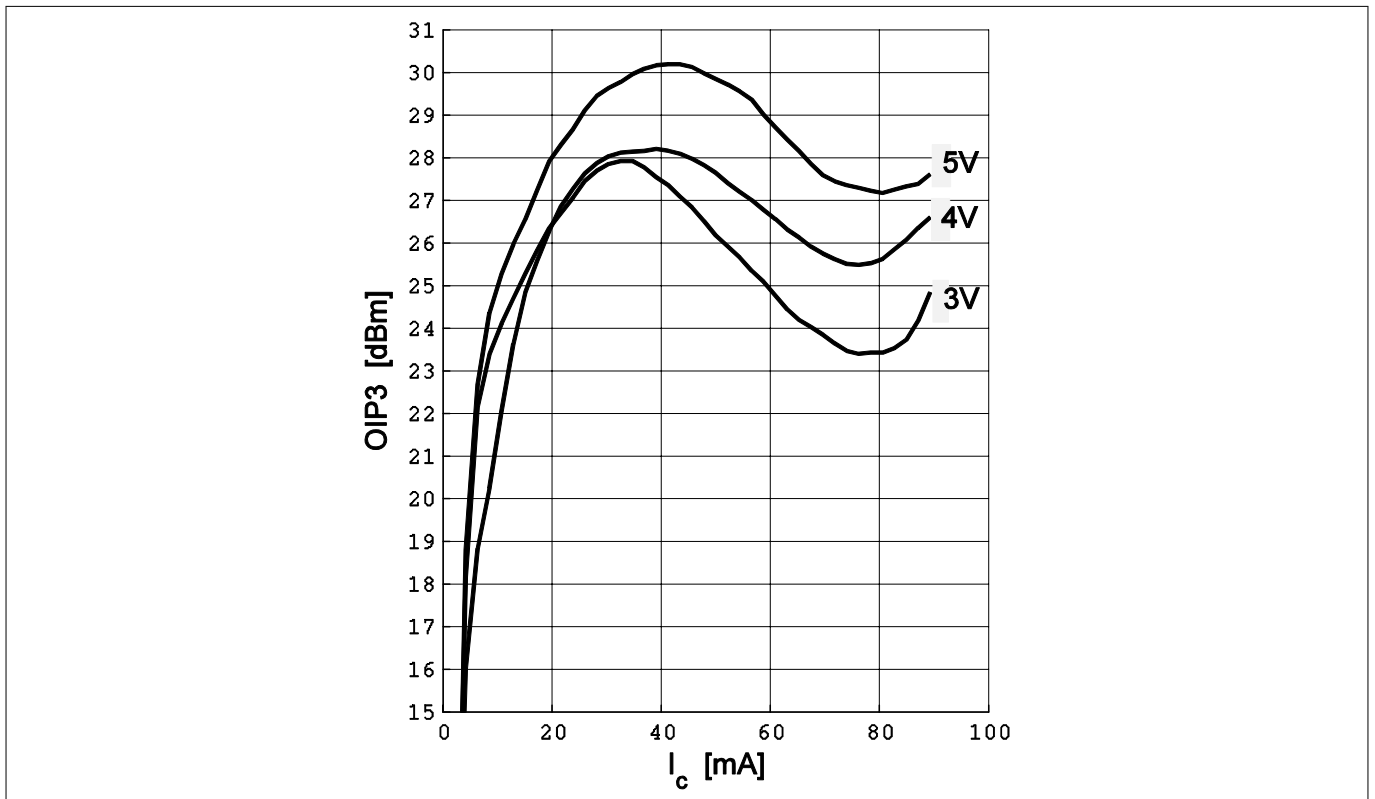

Figure 6 3rd order intercept point $OIP_3 = f(I_C)$, $Z_S = Z_L = 50 \Omega$, $f = 900 \text{ MHz}$, $V_{CE} = \text{parameter}$

Electrical characteristics

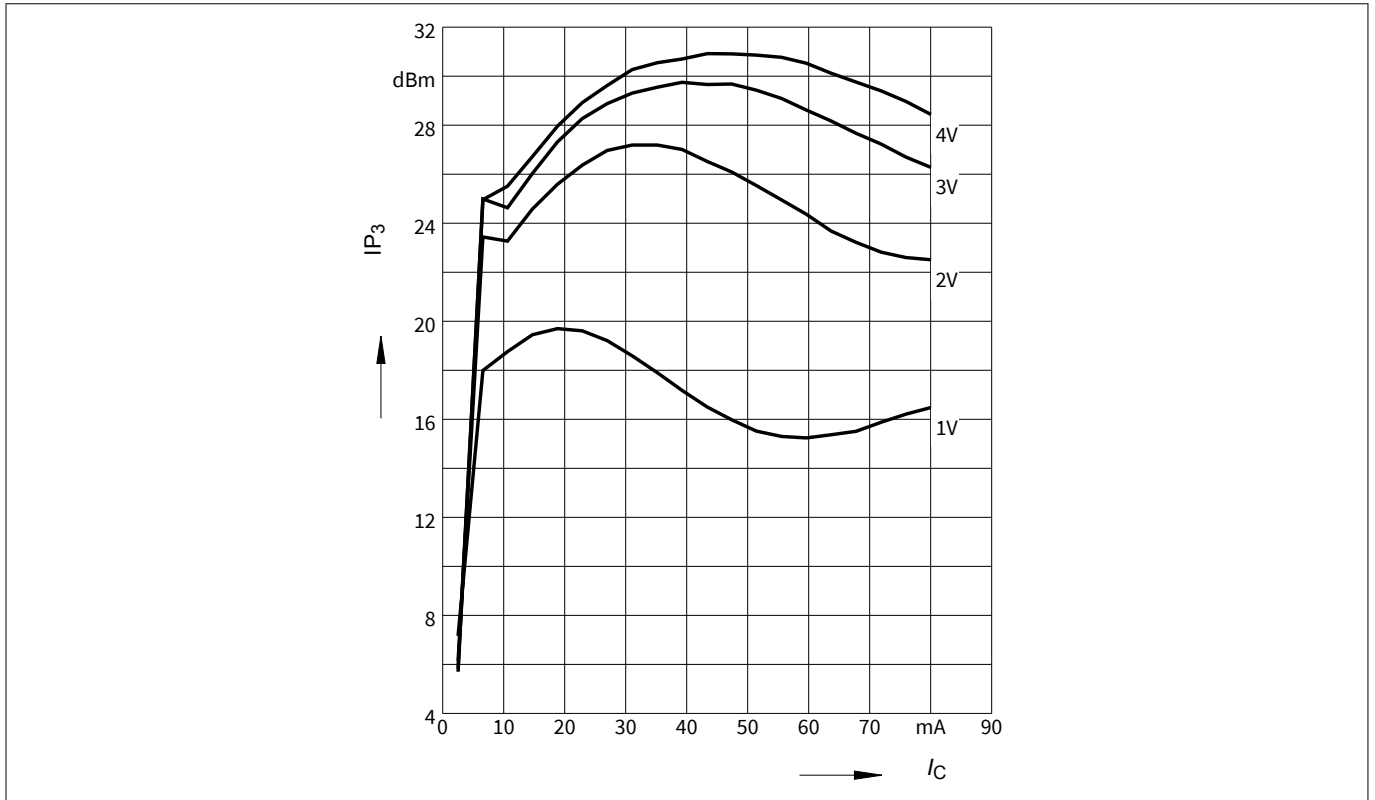

Figure 7 3rd order intercept point $OIP_3 = f(I_C)$, $Z_S = Z_L = 50 \Omega$, $f = 1.8 \text{ GHz}$, $V_{CE} = \text{parameter}$

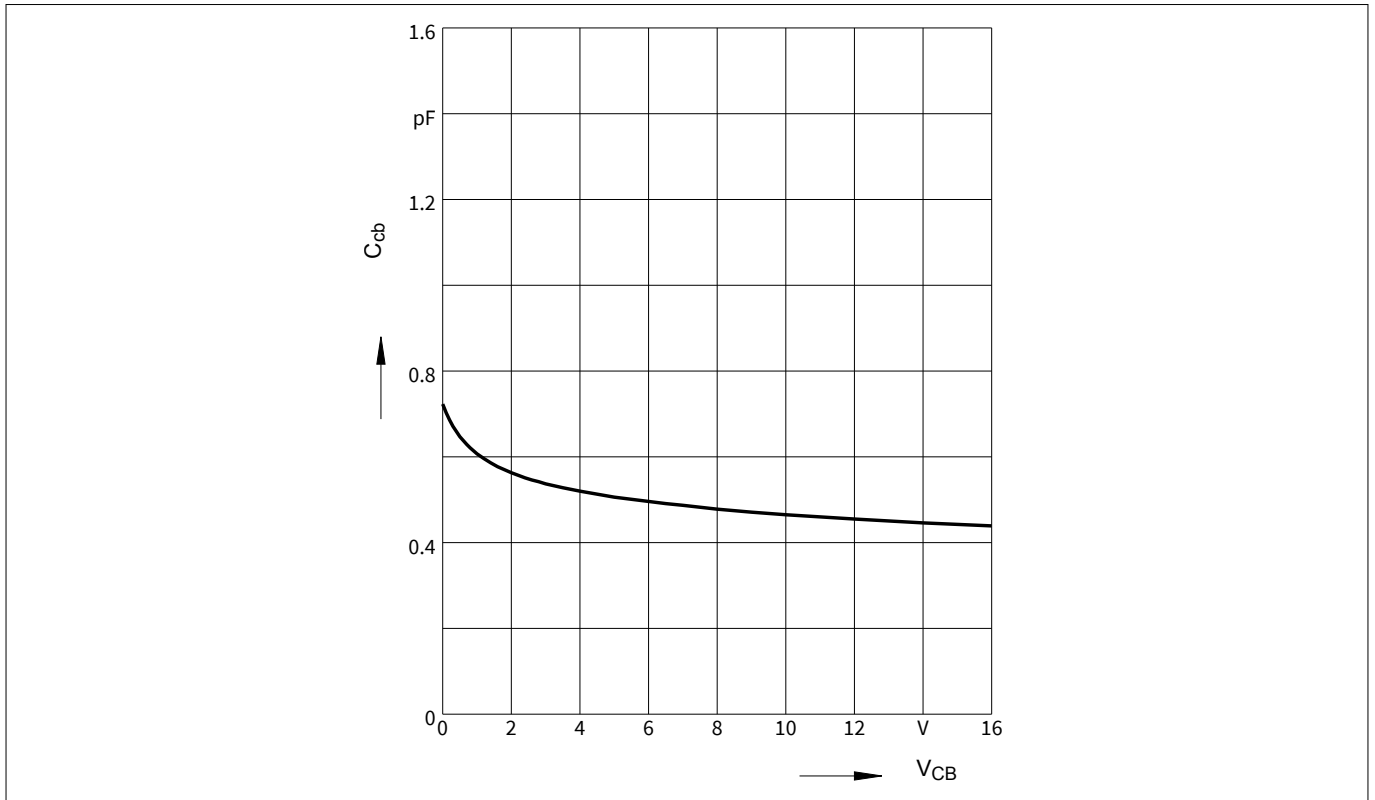

Figure 8 Collector base capacitance $C_{CB} = f(V_{CB})$, $f = 1 \text{ MHz}$

Electrical characteristics

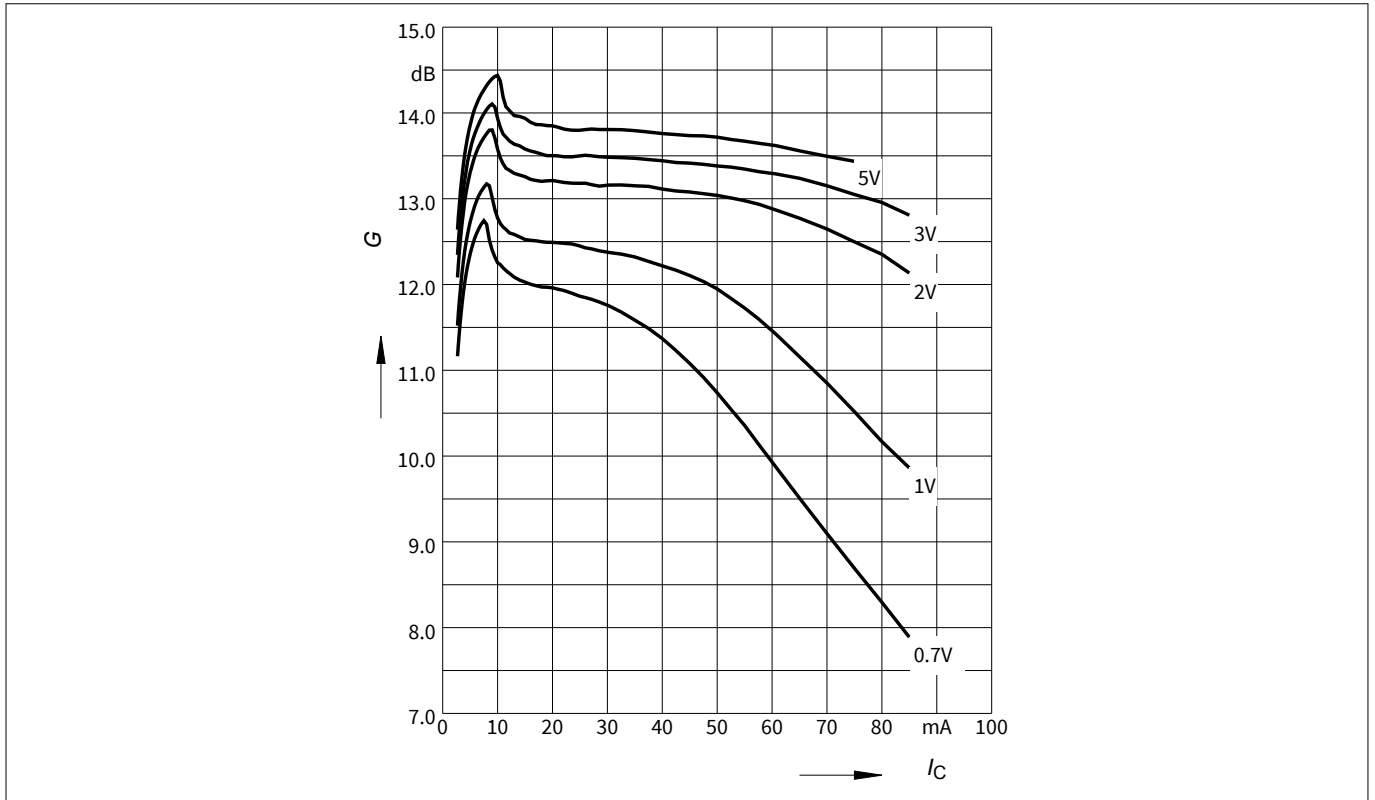

Figure 9 Gain $G_{ma}, G_{ms} = f(I_C), f = 1.8 \text{ GHz}, V_{CE} = \text{parameter}$

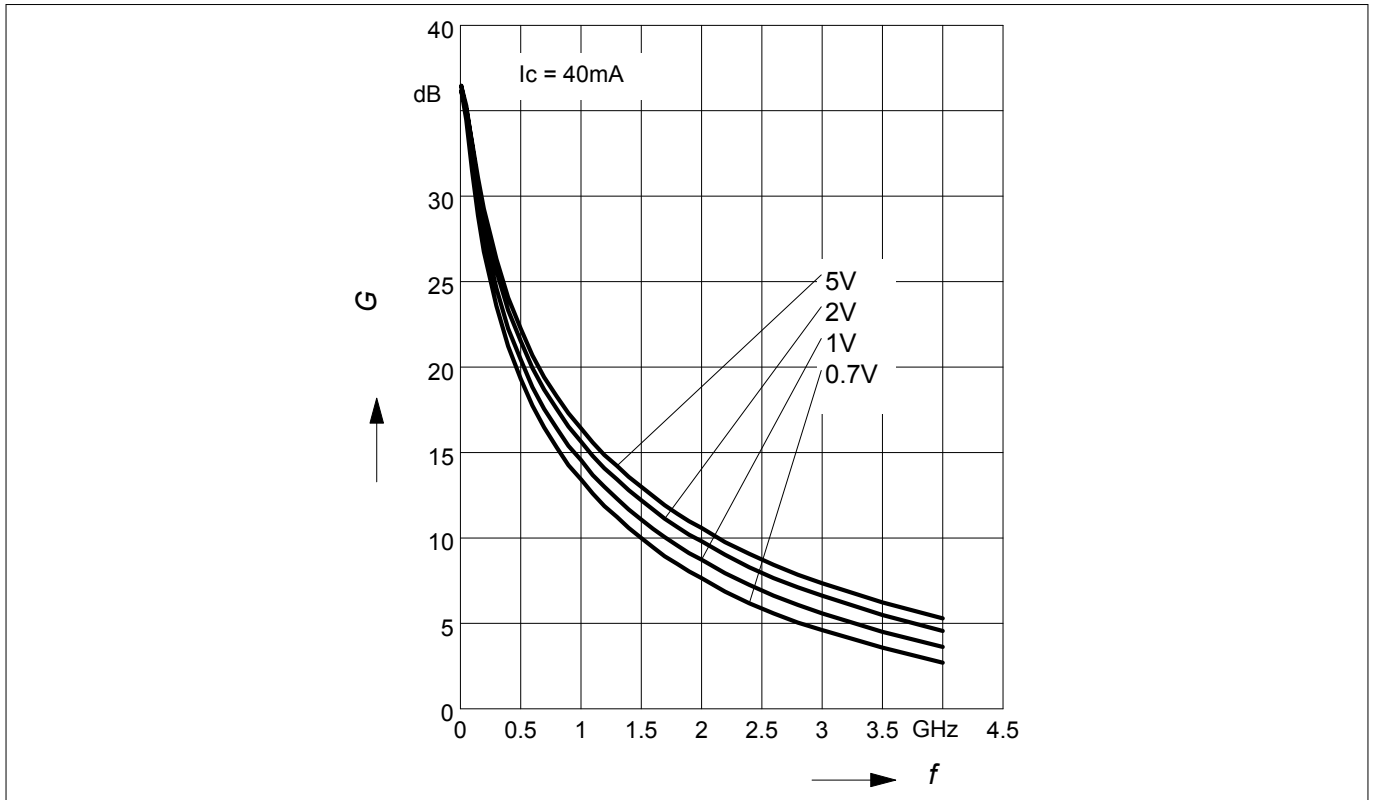

Figure 10 Gain $IS_{21}I^2 = f(f), I_C = 40 \text{ mA}, V_{CE} = \text{parameter}$

Electrical characteristics

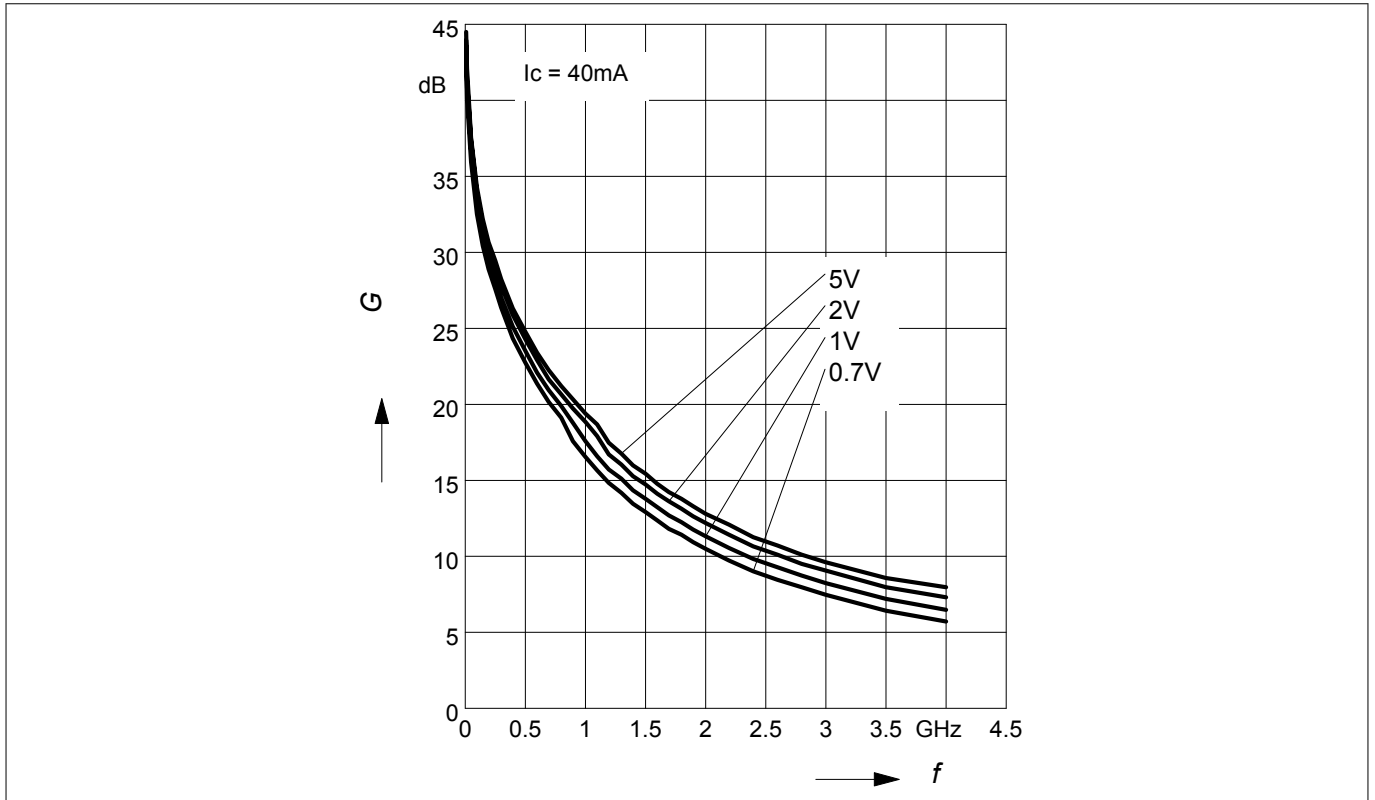

Figure 11 Gain $G_{ma}, G_{ms} = f(f), I_C = 40 \text{ mA}, V_{CE} = \text{parameter}$

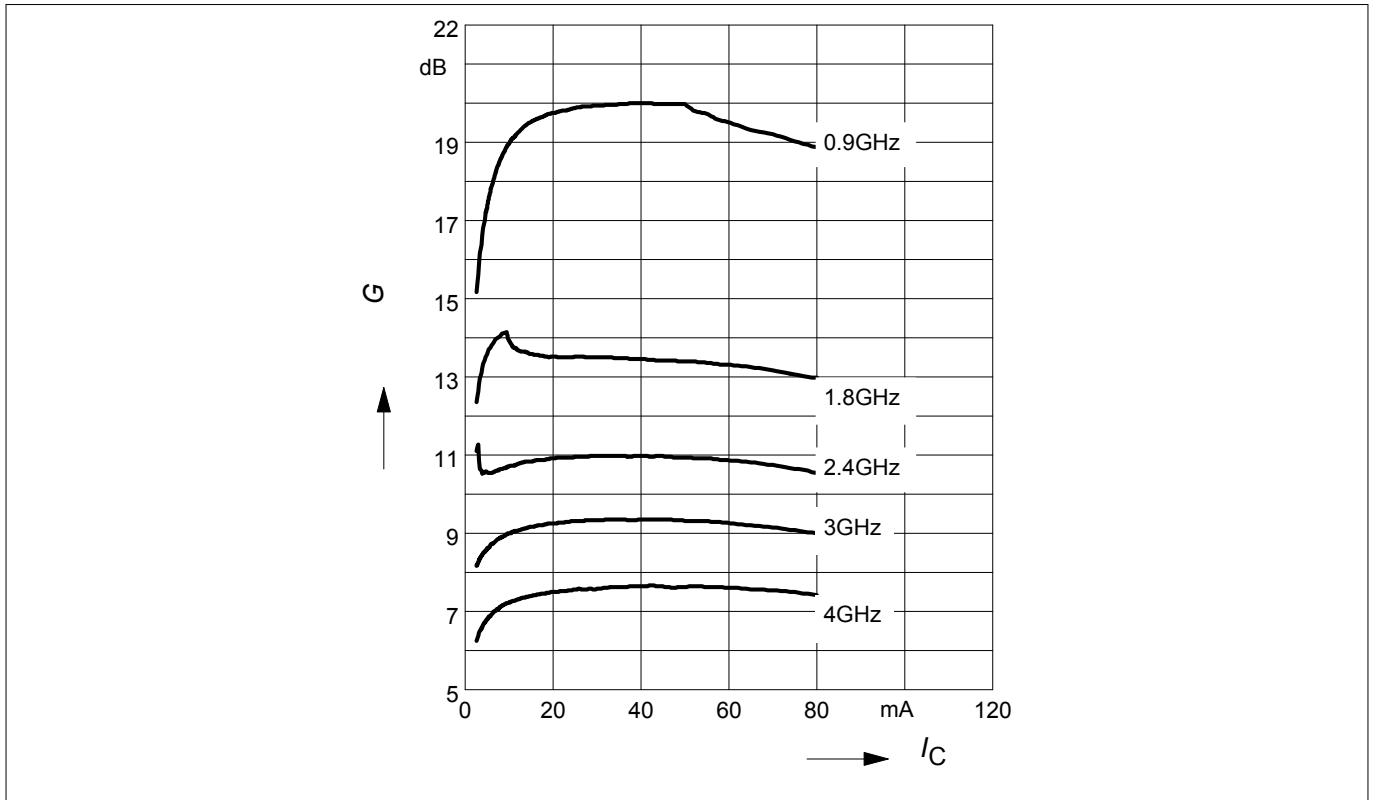

Figure 12 Maximum power gain $G_{max} = f(I_C), V_{CE} = 3 \text{ V}, f = \text{parameter in GHz}$

Electrical characteristics

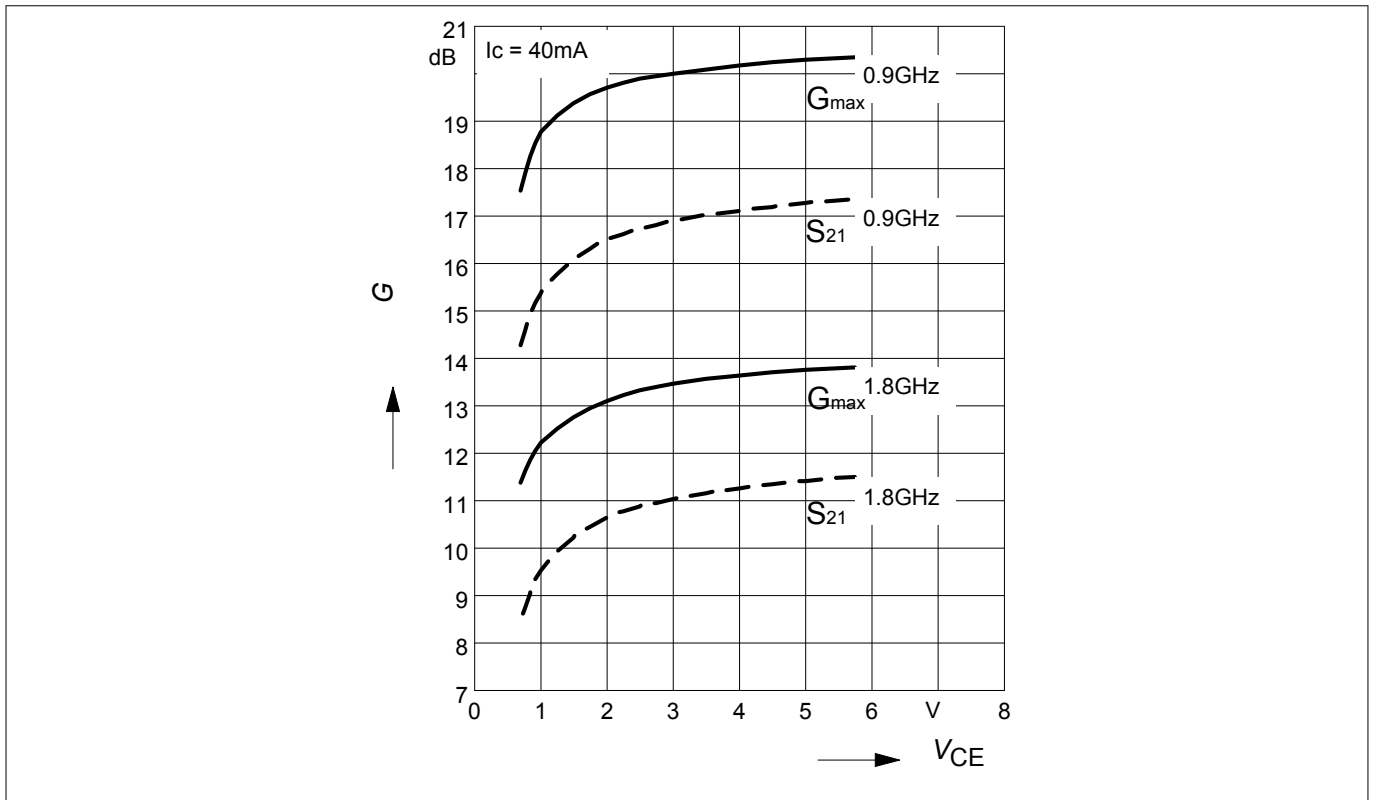

Figure 13 Maximum power gain $G_{max} = f(V_{CE})$, transducer gain $IS_{21}^2 = f(f)$, $I_C = 40\text{ mA}$, $f =$ parameter in GHz

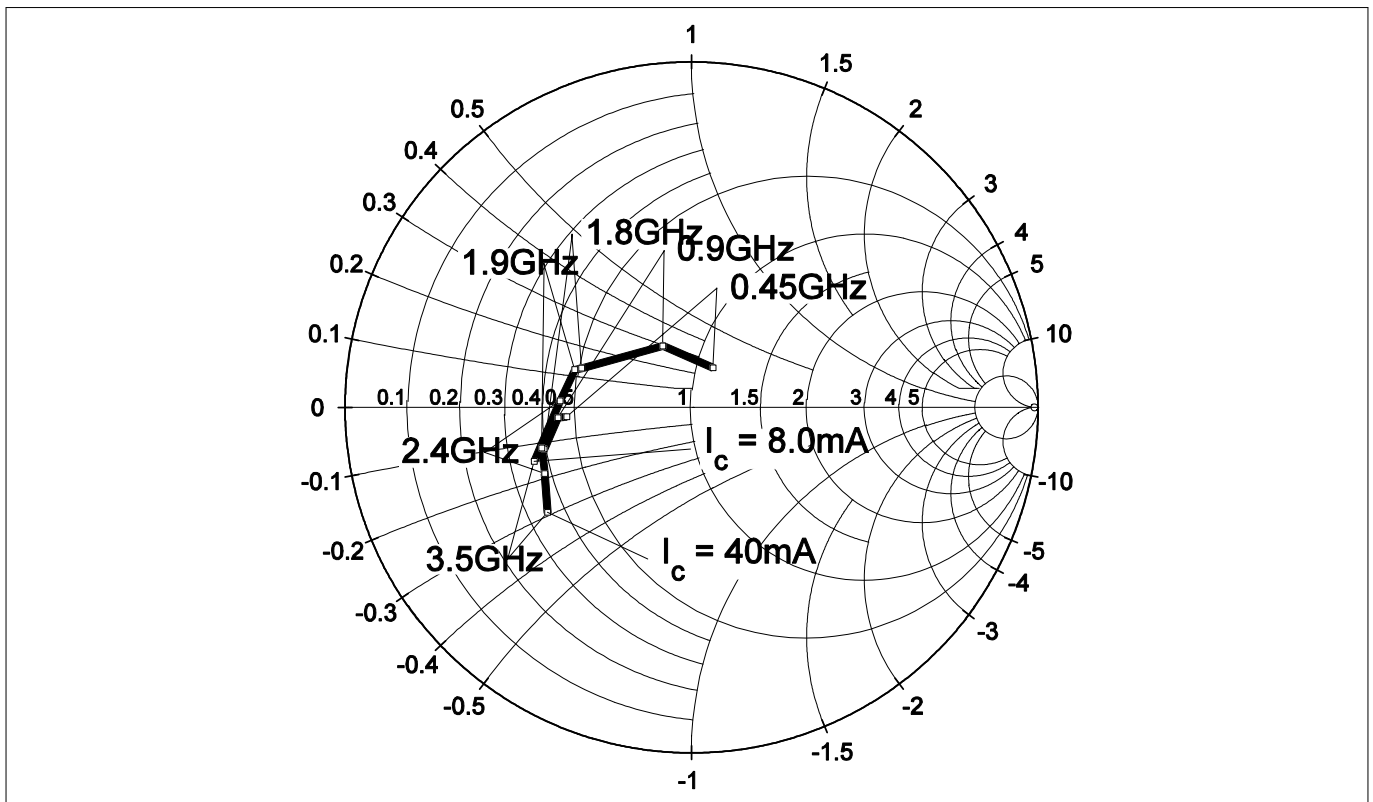

Figure 14 Source impedance for minimum noise figure $Z_{S,opt} = f(f)$, $V_{CE} = 3\text{ V}$, $I_C = 8 / 40\text{ mA}$

Electrical characteristics

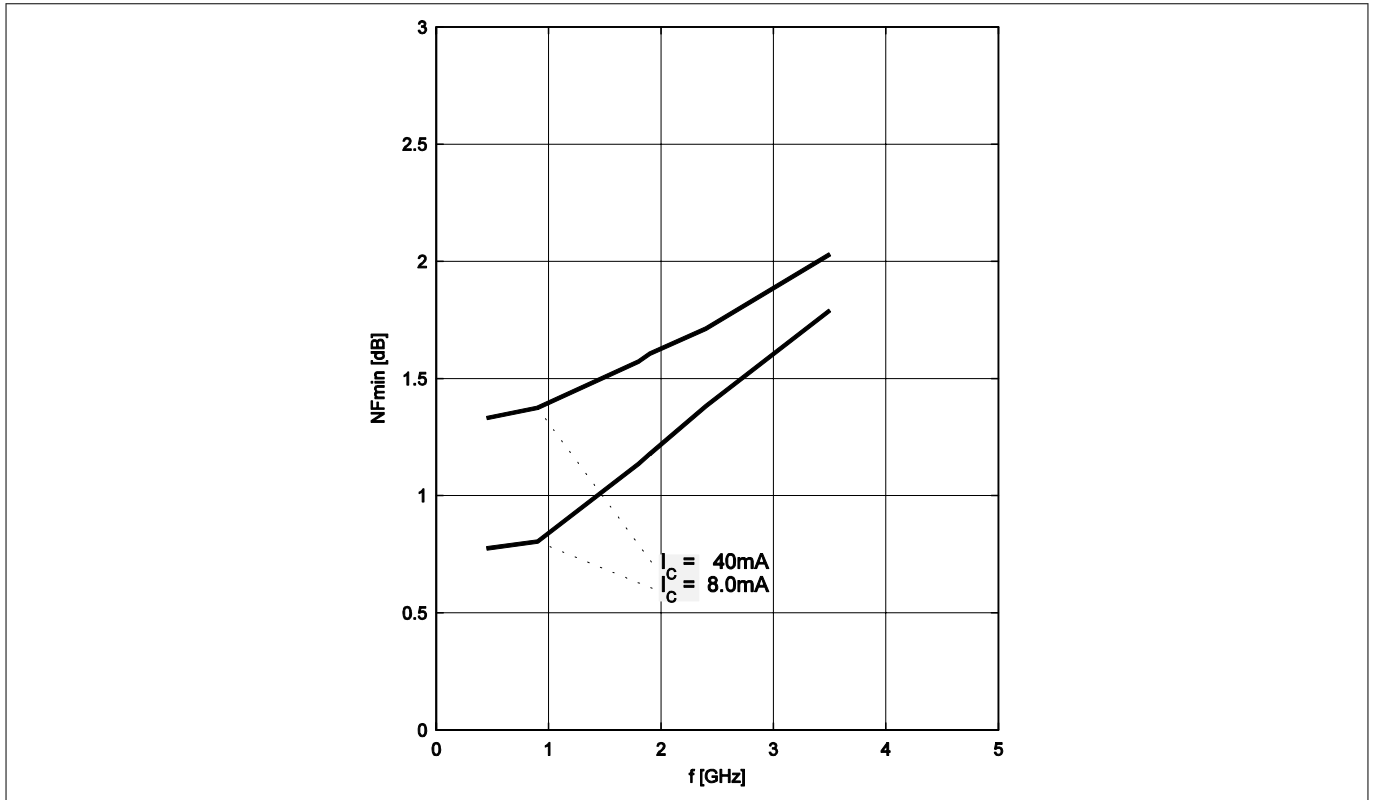

Figure 15 Noise figure $NF_{min} = f(f)$, $V_{CE} = 3\text{ V}$, $Z_S = Z_{S,opt}$, $I_C = 8 / 40\text{ mA}$

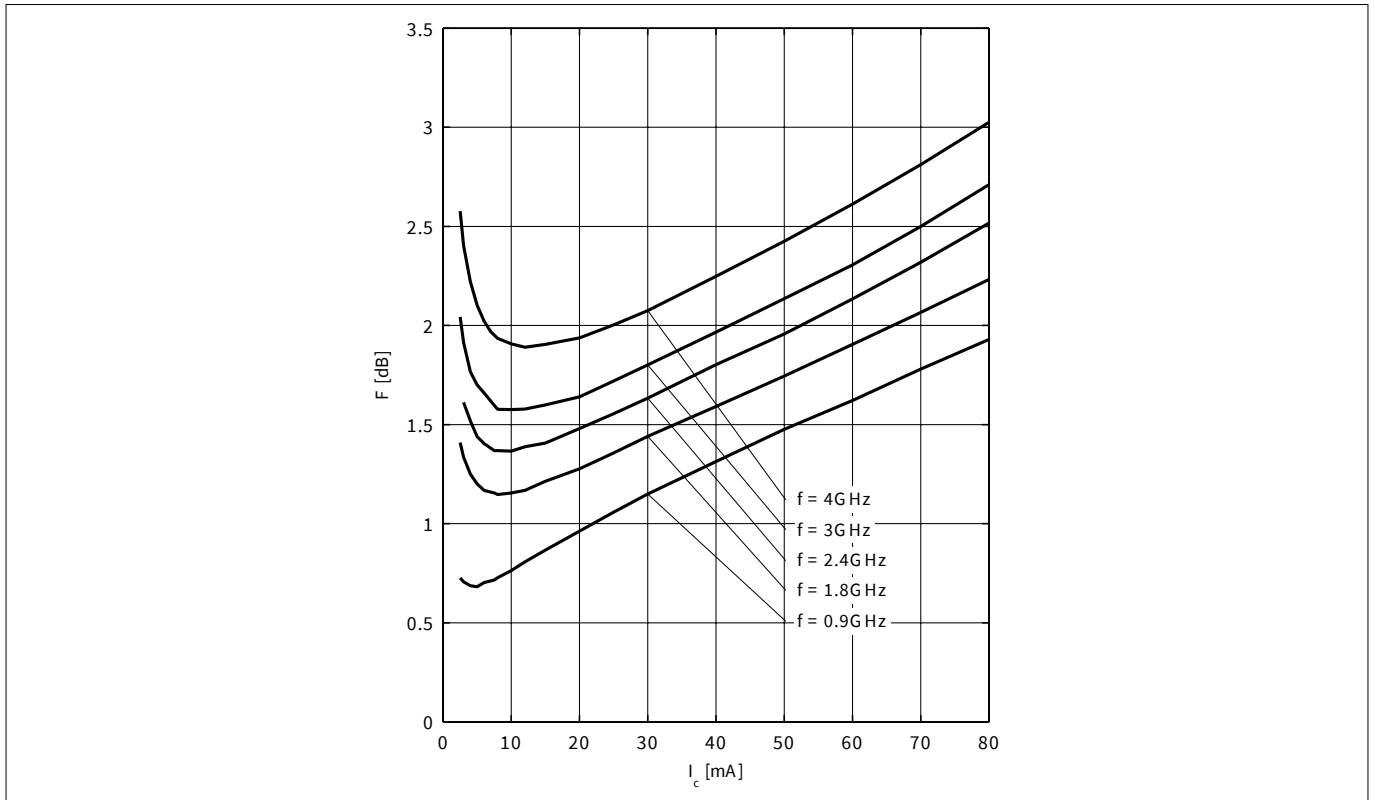

Figure 16 Noise figure $NF_{min} = f(I_C)$, $V_{CE} = 3\text{ V}$, $Z_S = Z_{S,opt}$, $f = \text{parameter in GHz}$

Electrical characteristics

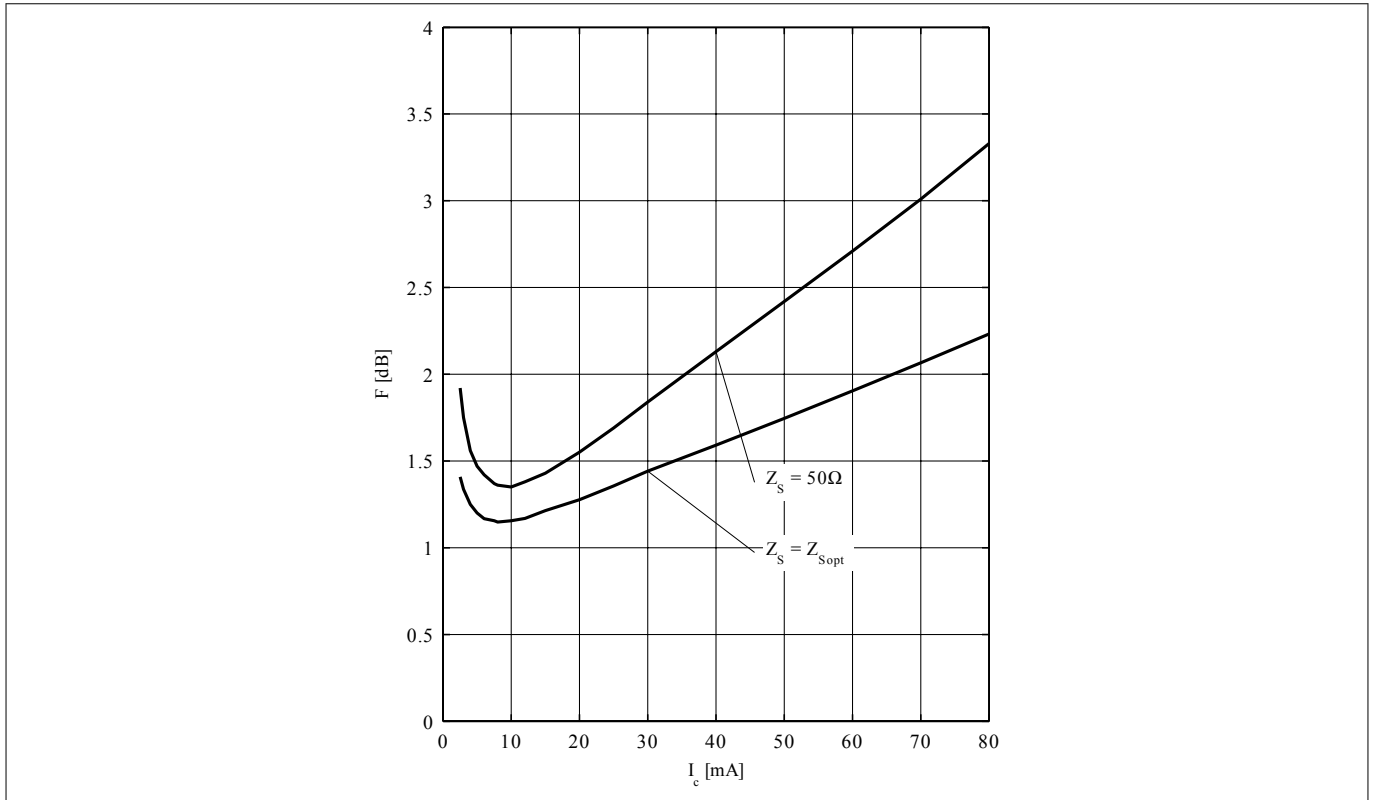

Figure 17 Noise figure $NF_{min} = f(I_c), Z_s = Z_{s,opt}, NF_{50} = f(I_c), Z_s = 50 \Omega, V_{CE} = 3 V, f = 1.8 GHz$

Note: The curves shown in this chapter have been generated using typical devices but shall not be considered as a guarantee that all devices have identical characteristic curves. $T_A = 25^\circ C$.

Package information TSFP-3-1

4 Package information TSFP-3-1

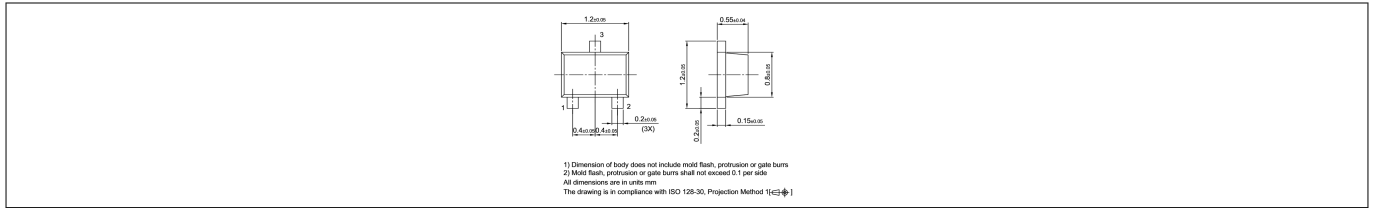

Figure 18 Package outline

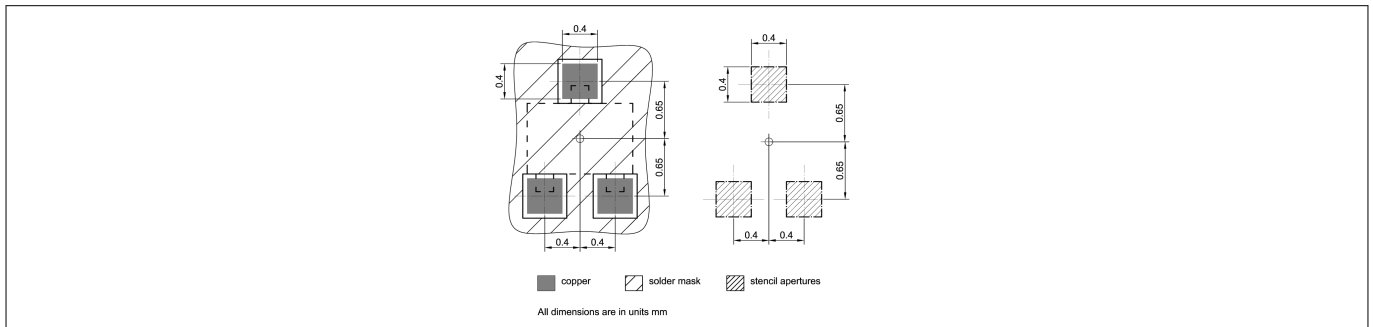

Figure 19 Foot print

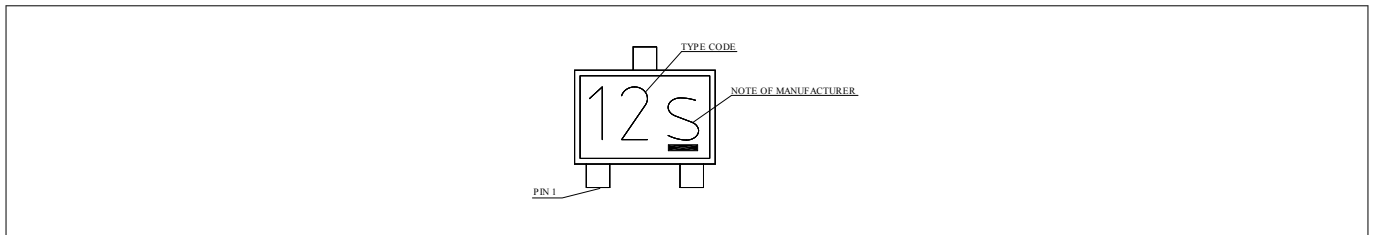

Figure 20 Marking layout example

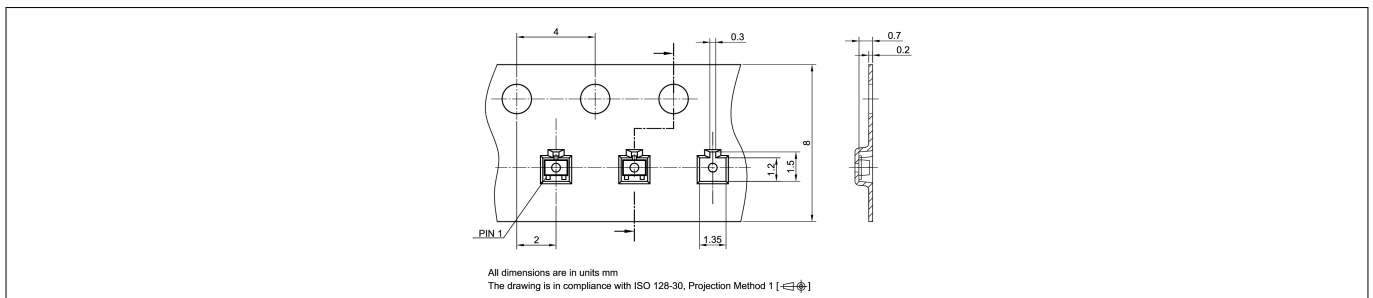

Figure 21 Tape information

Revision history

Revision history

| Document version | Date of release | Description of changes |
|------------------|-----------------|---|
| Revision 2.0 | 2019-01-25 | New datasheet layout, typical curves removed. |

Trademarks

All referenced product or service names and trademarks are the property of their respective owners.

Edition 2019-01-25

Published by
Infineon Technologies AG
81726 Munich, Germany

© 2019 Infineon Technologies AG
All Rights Reserved.

Do you have a question about any
aspect of this document?
Email: erratum@infineon.com

Document reference
IFX-bf11526274633746

IMPORTANT NOTICE

The information given in this document shall in no event be regarded as a guarantee of conditions or characteristics ("Beschaffheitsgarantie").

With respect to any examples, hints or any typical values stated herein and/or any information regarding the application of the product, Infineon Technologies hereby disclaims any and all warranties and liabilities of any kind, including without limitation warranties of non-infringement of intellectual property rights of any third party.

In addition, any information given in this document is subject to customer's compliance with its obligations stated in this document and any applicable legal requirements, norms and standards concerning customer's products and any use of the product of Infineon Technologies in customer's applications.

The data contained in this document is exclusively intended for technically trained staff. It is the responsibility of customer's technical departments to evaluate the suitability of the product for the intended application and the completeness of the product information given in this document with respect to such application.

WARNINGS

Due to technical requirements products may contain dangerous substances. For information on the types in question please contact your nearest Infineon Technologies office.

Except as otherwise explicitly approved by Infineon Technologies in a written document signed by authorized representatives of Infineon Technologies, Infineon Technologies' products may not be used in any applications where a failure of the product or any consequences of the use thereof can reasonably be expected to result in personal injury

Looking for pricing, stock, or lifecycle information?

Click below to explore more details on WIN SOURCE:

-  [View BFP 840FESD H6327 on WIN SOURCE](#)
-  [Infineon Technologies](#) Information

Optimize Your Supply Chain with WIN SOURCE Solutions

-  Global Sourcing Solution
-  Obsolete Management
-  Cost Control Management
-  Shortage Management
-  Alternative Solution
-  Excess Inventory Management