

Overview

KEMET’s Automotive Grade High Voltage surface mount MLCCs in X7R Dielectric feature a 125°C maximum operating temperature and are considered “temperature stable.” The Electronics Industries Alliance (EIA) characterizes X7R dielectric as a Class II material. Components of this classification are fixed, ceramic dielectric capacitors suited for bypass and decoupling applications or for frequency discriminating circuits where Q and stability of capacitance characteristics are not critical. X7R exhibits a predictable change in capacitance with respect to time and voltage and boasts a minimal change in capacitance with reference to ambient temperature. Capacitance change is limited to ±15% from -55°C to +125°C.

Whether under-hood or in-cabin, these capacitors are designed to provide reliable performance in mission and safety critical automotive circuits. Stricter testing protocol and inspection criteria have been established for automotive grade products in recognition of potentially harsh environmental conditions. KEMET automotive grade series capacitors meet the demanding Automotive Electronics Council’s AEC-Q200 qualification requirements.

Applications

- Charging stations
- LCD fluorescent backlight ballasts
- Voltage multiplier circuits
- DC/DC converters
- Power supply
- LAN/WAN interface
- High voltage decoupling
- Filters
- DC blocking
- ESD Protection

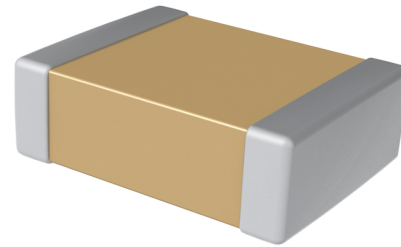

Ordering Information

| C | 1210 | C | 154 | K | C | R | A | C | AUTO |
|---------|--|-----------------------|---|---------------------------------|---|------------|----------------------|---------------------------------|---|
| Ceramic | Case Size (L" x W") | Specification/ Series | Capacitance Code (pF) | Capacitance Tolerance | Rated Voltage (VDC) | Dielectric | Failure Rate/ Design | Termination Finish ¹ | Packaging/Grade (C-Spec) |
| | 0402 0603 0805 1206 1210 1808 1812 1825 2220 2225 | C = Standard | Two significant digits and number of zeros. | J = ±5% K = ±10% M = ±20% | C = 500 B = 630 D = 1,000 F = 1,500 G = 2,000 Z = 2,500 H = 3,000 | R = X7R | A = N/A | C = 100% Matte Sn | See "Packaging C-Spec Ordering Options Table" |

¹ Additional termination finish options may be available. Contact KEMET for details.

Surface Mount Multilayer Ceramic Chip Capacitors (SMD MLCCs) High Voltage X7R Dielectric, 500 – 3,000 VDC (Automotive Grade)

Packaging C-Spec Ordering Options Table

| Packaging Type ¹ | Packaging/Grade Ordering Code (C-Spec) ² |
|-----------------------------|---|
| 7" Reel | AUTO |
| 13" Reel/Unmarked | AUTO7411 (EIA 0603 and smaller case sizes) AUTO7210 (EIA 0805 and larger case sizes) |

¹ Reeling tape options (Paper or Plastic) are dependent on capacitor case size (L" x W") and thickness dimension. See "Chip Thickness/Tape & Reel Packaging Quantities" and "Tape & Reel Packaging Information."

² All automotive packaging C-Specs listed exclude the option to laser mark components. Please contact KEMET if you require a laser marked option. For more information see "Capacitor Marking."

² For additional information regarding "AUTO" C-Spec options, see "Automotive C-Spec Information."

Benefits

- AEC-Q200 automotive qualified
- -55°C to +125°C operating temperature range
- Industry-leading CV values
- Exceptional performance at high frequencies
- Lead (Pb)-free, RoHS and REACH compliant
- EIA 0402, 0603, 0805, 1206, 1210, 1808, 1812, 1825, 2220 & 2225 case sizes
- DC voltage ratings of 500 V, 630 V, 1 KV, 1.5 KV, 2 KV, 2.5 KV, and 3 KV
- Capacitance offerings ranging from 10 pF to 560 nF
- Available capacitance tolerances of ±5%, ±10%, and ±20%
- Low ESR and ESL
- Non-polar device, minimizing installation concerns
- 100% pure matte tin-plated termination finish allowing for excellent solderability

Application Note

X7R dielectric is not recommended for AC line filtering or pulse applications. These capacitors and/or the assembled circuit board containing these capacitors may require a protective surface coating to prevent external surface arcing.

Automotive C-Spec Information

KEMET automotive grade products meet or exceed the requirements outlined by the Automotive Electronics Council. Details regarding test methods and conditions are referenced in document AEC-Q200, Stress Test Qualification for Passive Components. These products are supported by a Product Change Notification (PCN) and Production Part Approval Process warrant (PPAP).

Automotive products offered through our distribution channel have been assigned an inclusive ordering code C-Spec, "AUTO." This C-Spec was developed in order to better serve small and medium-sized companies that prefer an automotive grade component without the requirement to submit a customer Source Controlled Drawing (SCD) or specification for review by a KEMET engineering specialist. This C-Spec is therefore not intended for use by KEMET OEM automotive customers and are not granted the same "privileges" as other automotive C-Specs. Customer PCN approval and PPAP request levels are limited (see details below.)

Product Change Notification (PCN)

The KEMET product change notification system is used to communicate primarily the following types of changes:

- Product/process changes that affect product form, fit, function, and/or reliability
- Changes in manufacturing site
- Product obsolescence

| KEMET Automotive C-Spec | Customer Notification Due To: | | Days Prior To Implementation |
|-----------------------------|----------------------------------|---------------|------------------------------|
| | Process/Product change | Obsolescence* | |
| KEMET assigned ¹ | Yes (with approval and sign off) | Yes | 180 days minimum |
| AUTO | Yes (without approval) | Yes | 90 days minimum |

¹ KEMET assigned C-Specs require the submittal of a customer SCD or customer specification for review. For additional information contact KEMET.

Production Part Approval Process (PPAP)

The purpose of the Production Part Approval Process is:

- To ensure that supplier can meet the manufacturability and quality requirements for the purchased parts.
- To provide the evidence that all customer engineering design records and specification requirements are properly understood and fulfilled by the manufacturing organization.
- To demonstrate that the established manufacturing process has the potential to produce the part.

| KEMET Automotive C-Spec | PPAP Level | | | | |
|-----------------------------|------------|---|---|---|---|
| | 1 | 2 | 3 | 4 | 5 |
| KEMET assigned ¹ | ● | ● | ● | ● | ● |
| AUTO | | | ○ | | |

¹ KEMET assigned C-Specs require the submittal of a customer SCD or customer specification for review. For additional information contact KEMET.

- Part number specific PPAP available with customer information included.
- Product family PPAP only

Surface Mount Multilayer Ceramic Chip Capacitors (SMD MLCCs) High Voltage X7R Dielectric, 500 – 3,000 VDC (Automotive Grade)

Dimensions – Millimeters (Inches)



| EIA Size Code | Metric Size Code | L Length | W Width | T Thickness | B Bandwidth | S Separation Minimum | Mounting Technique |
|---------------|------------------|-------------------------------|-------------------------------|---------------------------|-------------------------------|----------------------|------------------------------|
| 0402 | 1005 | 1.00 (0.040) ±0.05 (0.002) | 0.50 (0.020) ±0.05 (0.002) | See Table 2 for Thickness | 0.30 (0.012) ±0.10 (0.004) | 0.30 (0.012) | Solder Reflow Only |
| 0603 | 1608 | 1.60 (0.063) ±0.15 (0.006) | 0.80 (0.032) ±0.15 (0.006) | | 0.35 (0.014) ±0.15 (0.006) | 0.50 (0.020) | Solder wave or Solder reflow |
| 0805 | 2012 | 2.00 (0.079) ±0.20 (0.008) | 1.25 (0.049) ±0.20 (0.008) | | 0.50 (0.02) ±0.25 (0.010) | 0.70 (0.028) | |
| 1206 | 3216 | 3.20 (0.126) ±0.20 (0.008) | 1.60 (0.063) ±0.20 (0.008) | | 0.50 (0.02) ±0.25 (0.010) | 1.50 (0.060) | Solder reflow only |
| 1210 | 3225 | 3.20 (0.126) ±0.20 (0.008) | 2.50 (0.098) ±0.20 (0.008) | | 0.50 (0.02) ±0.25 (0.010) | 1.50 (0.060) | |
| 1808 | 4520 | 4.70 (0.185) ±0.50 (0.020) | 2.00 (0.079) ±0.20 (0.008) | | 0.60 (0.024) ±0.35 (0.014) | 2.90 (0.114) | |
| 1812 | 4532 | 4.50 (0.177) ±0.30 (0.012) | 3.20 (0.126) ±0.30 (0.012) | | 0.60 (0.024) ±0.35 (0.014) | 2.30 (0.091) | |
| 1825 | 4564 | 4.50 (0.177) ±0.30 (0.012) | 6.40 (0.252) ±0.40 (0.016) | | 0.60 (0.024) ±0.35 (0.014) | 2.30 (0.091) | |
| 2220 | 5650 | 5.70 (0.224) ±0.40 (0.016) | 5.00 (0.197) ±0.40 (0.016) | | 0.60 (0.024) ±0.35 (0.014) | 3.50 (0.138) | |
| 2225 | 5664 | 5.60 (0.220) ±0.40 (0.016) | 6.40 (0.248) ±0.40 (0.016) | | 0.60 (0.024) ±0.35 (0.014) | 3.20 (0.126) | |

Qualification/Certification

Automotive grade products meet or exceed the requirements outlined by the Automotive Electronics Council. Details regarding test methods and conditions are referenced in document AEC-Q200, Stress Test Qualification for Passive Components. For additional information regarding the Automotive Electronics Council and AEC-Q200, please visit their website at www.aecouncil.com.

Environmental Compliance

Lead (Pb)-free, RoHS, and REACH compliant without exemptions.

Surface Mount Multilayer Ceramic Chip Capacitors (SMD MLCCs) High Voltage X7R Dielectric, 500 – 3,000 VDC (Automotive Grade)

Electrical Parameters/Characteristics

| Item | Parameters/Characteristics |
|--|---|
| Operating Temperature Range | -55°C to +125°C |
| Capacitance Change with Reference to +25°C and 0 Vdc Applied (TCC) | ±15% |
| ¹ Aging Rate (Maximum % Capacitance Loss/Decade Hour) | 3.0% |
| ² Dielectric Withstanding Voltage (DWV) | See Dielectric Withstanding Voltage (DWV) Table (5 ±1 seconds and charge/discharge not exceeding 50 mA) |
| ³ Dissipation Factor (DF) Maximum Limit at 25°C | 2.5% |
| ⁴ Insulation Resistance (IR) Minimum Limit at 25°C | See Insulation Resistance Limit Table (500 VDC applied for 120 ±5 seconds at 25°C) |

¹Regarding aging rate: Capacitance measurements (including tolerance) are indexed to a referee time of 1,000 hours.

²DWV is the voltage a capacitor can withstand (survive) for a short period of time. It exceeds the nominal and continuous working voltage of the capacitor.

³Capacitance and dissipation factor (DF) measured under the following conditions:

1 kHz ±50 Hz and $1.0 \pm 0.2 V_{rms}$ if capacitance $\leq 10 \mu F$

12 0Hz ±10 Hz and $0.5 \pm 0.1 V_{rms}$ if capacitance $> 10 \mu F$

⁴To obtain IR limit, divide $M\Omega\text{-}\mu F$ value by the capacitance and compare to $G\Omega$ limit. Select the lower of the two limits.

Note: When measuring capacitance it is important to ensure the set voltage level is held constant. The HP4284 & Agilent E4980 have a feature known as Automatic Level Control (ALC). The ALC feature should be switched to "ON."

DWV HV

| EIA Case Size | 500V | 630V | ≥ 1000V |
|---------------|-----------------------|------|-----------------------|
| 0402 | 120% of rated voltage | N/A | N/A |
| 0603 | 150% of rated voltage | | 120% of rated voltage |
| 0805 | | | |
| 1206 | | | |
| 1210 | | | |
| 1808 | | | |
| 1812 | | | |
| 1825 | | | |
| 2220 | | | |
| 2225 | | | |

Surface Mount Multilayer Ceramic Chip Capacitors (SMD MLCCs)
High Voltage X7R Dielectric, 500 – 3,000 VDC (Automotive Grade)

Post Environmental Limits

| High Temperature Life, Biased Humidity, Moisture Resistance | | | | | |
|---|------------------|-------------------|--------------------------------|-------------------|-----------------------|
| Dielectric | Rated DC Voltage | Capacitance Value | Dissipation Factor (Maximum %) | Capacitance Shift | Insulation Resistance |
| X7R | > 25 | All | 3.0 | ±20% | 10% of Initial limit |
| | 16/25 | | 5.0 | | |
| | < 16 | | 7.5 | | |

Insulation Resistance Limit Table (X7R Dielectric)

| EIA Case Size | 1,000 Megohm Microfarads or 100 GΩ | 100 Megohm Microfarads or 10 GΩ |
|---------------|------------------------------------|---------------------------------|
| 0402 | N/A | All |
| 0603 | N/A | All |
| 0805 | < 0.0039 μF | ≥ .0039 μF |
| 1206 | < 0.012 μF | ≥ 0.012 μF |
| 1210 | < 0.033 μF | ≥ 0.033 μF |
| 1808 | < 0.018 μF | ≥ 0.018 μF |
| 1812 | < 0.027 μF | ≥ 0.027 μF |
| 1825 | < 0.120 μF | ≥ 0.120 μF |
| 2220 | < 0.150 μF | ≥ 0.150 μF |
| 2225 | < 0.180 μF | ≥ 0.180 μF |

Surface Mount Multilayer Ceramic Chip Capacitors (SMD MLCCs)
High Voltage X7R Dielectric, 500 – 3,000 VDC (Automotive Grade)

Table 1A – Capacitance Range/Selection Waterfall (0402 – 1812 Case Sizes)

| Cap | Cap Code | Case Size/ Series | C0402C | C0603C | | | C0805C | | | C1206C | | | | | C1210C | | | | | C1808C | | | | | | C1812C ² | | | | | | | | |
|-----------|----------|-----------------------|---|--------|-----|------|--------|-----|------|--------|-----|------|------|------|--------|-----|------|------|------|--------|-----|------|------|------|------|---------------------|-----|-----|------|------|------|------|------|----|
| | | Voltage Code | C | C | B | D | C | B | D | C | B | D | F | G | C | B | D | F | G | Z | H | C | B | D | F | G | Z | H | | | | | | |
| | | Rated Voltage (VDC) | 500 | 500 | 630 | 1000 | 500 | 630 | 1000 | 500 | 630 | 1000 | 1500 | 2000 | 500 | 630 | 1000 | 1500 | 2000 | 500 | 630 | 1000 | 1500 | 2000 | 2500 | 3000 | 500 | 630 | 1000 | 1500 | 2000 | 2500 | 3000 | |
| | | Capacitance Tolerance | Product Availability and Chip Thickness Codes - See Table 2 for Chip Thickness Dimensions | | | | | | | | | | | | | | | | | | | | | | | | | | | | | | | |
| 10 pF | 100 | J K M | | | | DG | DG | DG | ED | ED | ED | ED | ED | FM | FM | FM | FM | FM | LB | LB | LB | LB | LB | LB | LB | LB | LB | GB | GB | GB | GB | GB | GB | GB |
| 11 pF | 110 | J K M | | | | DG | DG | DG | ED | ED | ED | ED | ED | FM | FM | FM | FM | FM | LB | LB | LB | LB | LB | LB | LB | LB | LB | GB | GB | GB | GB | GB | GB | GB |
| 12 pF | 120 | J K M | | | | DG | DG | DG | ED | ED | ED | ED | ED | FM | FM | FM | FM | FM | LB | LB | LB | LB | LB | LB | LB | LB | LB | GB | GB | GB | GB | GB | GB | GB |
| 13 pF | 130 | J K M | | | | DG | DG | DG | ED | ED | ED | ED | ED | FM | FM | FM | FM | FM | LB | LB | LB | LB | LB | LB | LB | LB | LB | GB | GB | GB | GB | GB | GB | GB |
| 15 pF | 150 | J K M | | | | DG | DG | DG | ED | ED | ED | ED | ED | FM | FM | FM | FM | FM | LB | LB | LB | LB | LB | LB | LB | LB | LB | GB | GB | GB | GB | GB | GB | GB |
| 16 pF | 160 | J K M | | | | DG | DG | DG | ED | ED | ED | ED | ED | FM | FM | FM | FM | FM | LB | LB | LB | LB | LB | LB | LB | LB | LB | GB | GB | GB | GB | GB | GB | GB |
| 18 pF | 180 | J K M | | | | DG | DG | DG | ED | ED | ED | ED | ED | FM | FM | FM | FM | FM | LB | LB | LB | LB | LB | LB | LB | LB | LB | GB | GB | GB | GB | GB | GB | GB |
| 20 pF | 200 | J K M | | | | DG | DG | DG | ED | ED | ED | ED | ED | FM | FM | FM | FM | FM | LB | LB | LB | LB | LB | LB | LB | LB | LB | GB | GB | GB | GB | GB | GB | GB |
| 22 pF | 220 | J K M | | | | DG | DG | DG | ED | ED | ED | ED | ED | FM | FM | FM | FM | FM | LB | LB | LB | LB | LB | LB | LB | LB | LB | GB | GB | GB | GB | GB | GB | GB |
| 24 pF | 240 | J K M | | | | DG | DG | DG | ED | ED | ED | ED | ED | FM | FM | FM | FM | FM | LB | LB | LB | LB | LB | LB | LB | LB | LB | GB | GB | GB | GB | GB | GB | GB |
| 27 pF | 270 | J K M | | | | DG | DG | DG | ED | ED | ED | ED | ED | FM | FM | FM | FM | FM | LB | LB | LB | LB | LB | LB | LB | LB | LB | GB | GB | GB | GB | GB | GB | GB |
| 30 pF | 300 | J K M | | | | DG | DG | DG | ED | ED | ED | ED | ED | FM | FM | FM | FM | FM | LB | LB | LB | LB | LB | LB | LB | LB | LB | GB | GB | GB | GB | GB | GB | GB |
| 33 pF | 330 | J K M | | | | DG | DG | DG | ED | ED | ED | ED | ED | FM | FM | FM | FM | FM | LB | LB | LB | LB | LB | LB | LB | LB | LB | GB | GB | GB | GB | GB | GB | GB |
| 36 pF | 360 | J K M | | | | DG | DG | DG | ED | ED | ED | ED | ED | FM | FM | FM | FM | FM | LB | LB | LB | LB | LB | LB | LB | LB | LB | GB | GB | GB | GB | GB | GB | GB |
| 39 pF | 390 | J K M | | | | DG | DG | DG | ED | ED | ED | ED | ED | FM | FM | FM | FM | FM | LB | LB | LB | LB | LB | LB | LB | LB | LB | GB | GB | GB | GB | GB | GB | GB |
| 43 pF | 430 | J K M | | | | DG | DG | DG | ED | ED | ED | ED | ED | FM | FM | FM | FM | FM | LB | LB | LB | LB | LB | LB | LB | LB | LB | GB | GB | GB | GB | GB | GB | GB |
| 47 pF | 470 | J K M | | | | DG | DG | DG | ED | ED | ED | ED | ED | FM | FM | FM | FM | FM | LB | LB | LB | LB | LB | LB | LB | LB | LB | GB | GB | GB | GB | GB | GB | GB |
| 51 pF | 510 | J K M | | | | DG | DG | DG | ED | ED | ED | ED | ED | FM | FM | FM | FM | FM | LB | LB | LB | LB | LB | LB | LB | LB | LB | GB | GB | GB | GB | GB | GB | GB |
| 56 pF | 560 | J K M | | | | DG | DG | DG | ED | ED | ED | ED | ED | FM | FM | FM | FM | FM | LB | LB | LB | LB | LB | LB | LB | LB | LB | GB | GB | GB | GB | GB | GB | GB |
| 62 pF | 620 | J K M | | | | DG | DG | DG | ED | ED | ED | ED | ED | FM | FM | FM | FM | FM | LB | LB | LB | LB | LB | LB | LB | LB | LB | GB | GB | GB | GB | GB | GB | GB |
| 68 pF | 680 | J K M | | | | DG | DG | DG | ED | ED | ED | ED | ED | FM | FM | FM | FM | FM | LB | LB | LB | LB | LB | LB | LB | LB | LB | GB | GB | GB | GB | GB | GB | GB |
| 75 pF | 750 | J K M | | | | DG | DG | DG | ED | ED | ED | ED | ED | FM | FM | FM | FM | FM | LB | LB | LB | LB | LB | LB | LB | LB | LB | GB | GB | GB | GB | GB | GB | GB |
| 82 pF | 820 | J K M | | | | DG | DG | DG | ED | ED | ED | ED | ED | FM | FM | FM | FM | FM | LB | LB | LB | LB | LB | LB | LB | LB | LB | GB | GB | GB | GB | GB | GB | GB |
| 91 pF | 910 | J K M | | | | DG | DG | DG | ED | ED | ED | ED | ED | FM | FM | FM | FM | FM | LB | LB | LB | LB | LB | LB | LB | LB | LB | GD | GD | GD | GD | GD | GD | GD |
| 100 pF | 101 | J K M | | | | DG | DG | DG | ED | ED | ED | ED | ED | FM | FM | FM | FM | FM | LB | LB | LB | LB | LB | LB | LB | LB | LB | GD | GD | GD | GD | GD | GD | GD |
| 110 pF | 111 | J K M | | | | DG | DG | DG | ED | ED | ED | ED | ED | FM | FM | FM | FM | FM | LB | LB | LB | LB | LB | LB | LB | LB | LB | GD | GD | GD | GD | GD | GD | GD |
| 120 pF | 121 | J K M | | | | DG | DG | DG | ED | ED | ED | ED | ED | FM | FM | FM | FM | FM | LA | LA | LA | LA | LA | LA | LA | LA | LA | GD | GD | GD | GD | GD | GD | GD |
| 130 pF | 131 | J K M | | | | DG | DG | DG | ED | ED | ED | ED | ED | FG | FG | FG | FM | FM | LA | LA | LA | LA | LA | LA | LA | LA | LA | GD | GD | GD | GD | GD | GD | GD |
| 150 pF | 151 | J K M | | | | DG | DG | DG | ED | ED | ED | ED | ED | FG | FG | FG | FM | FM | LA | LA | LA | LA | LA | LA | LA | LA | LA | GD | GD | GD | GD | GD | GD | GK |
| 180 pF | 181 | J K M | | | | DG | DG | DG | ED | ED | ED | ED | ED | FG | FG | FG | FM | FM | LA | LA | LA | LA | LA | LA | LA | LA | LA | GD | GD | GD | GD | GD | GD | GK |
| 220 pF | 221 | J K M | | | | DG | DG | DG | ED | ED | ED | ED | ED | FG | FG | FG | FM | FM | LA | LA | LA | LA | LA | LA | LA | LA | LA | GD | GD | GD | GD | GD | GD | GB |
| 270 pF | 271 | J K M | | | | DG | DG | DG | ED | ED | ED | ED | ED | FG | FG | FG | FK | FK | LA | LA | LA | LB | LC | LC | LC | LC | LC | GB | GB | GB | GB | GB | GH | GB |
| 330 pF | 331 | J K M | | | | DG | DG | DG | ED | ED | ED | ED | ED | FG | FG | FG | FK | FK | LA | LA | LA | LB | LC | LC | LC | LC | LC | GB | GB | GB | GB | GB | GH | GB |
| 390 pF | 391 | J K M | | | | DG | DG | DG | ED | ED | ED | ED | ED | FG | FG | FG | FS | FS | LA | LA | LA | LB | LB | LB | LB | LB | LB | GB | GB | GB | GB | GD | GK | GB |
| 470 pF | 471 | J K M | | | | DG | DG | DG | ED | ED | ED | ED | ED | FG | FG | FG | FS | FS | LA | LB | LB | LB | LB | LB | LB | LB | LB | GB | GB | GB | GB | GD | GK | GH |
| 560 pF | 561 | J K M | | | | DG | DG | DG | ED | ED | ED | ED | ED | FG | FM | FM | FS | FL | LA | LB | LB | LB | LB | LB | LB | LB | LB | GB | GB | GB | GD | GH | GH | GK |
| 680 pF | 681 | J K M | | | | DG | DG | DG | ED | ED | ED | ED | ED | FG | FM | FM | FS | FL | LB | LB | LB | LA | LB | LB | LB | LB | LB | GB | GB | GB | GD | GH | GH | GK |
| 820 pF | 821 | J K M | | | | DG | DG | DG | ED | ED | ED | ED | ED | FG | FM | FM | FL | FL | LB | LB | LB | LA | LB | LB | LB | LB | LB | GB | GB | GB | GD | GH | GH | GK |
| 1,000 pF | 102 | J K M | BB | CG | CG | CG | DG | DG | DG | ED | ED | ED | ED | EG | FM | FM | FM | FL | LB | LB | LB | LA | LB | LB | LB | LB | LB | GB | GB | GB | GD | GH | GH | GK |
| 1,200 pF | 122 | J K M | BB | CG | CG | | DG | DG | DG | ED | ED | ED | ED | EG | FM | FK | FK | FL | LC | LC | LC | LB | LB | LB | LB | LB | LB | GB | GB | GB | GB | GH | GK | GK |
| 1,500 pF | 152 | J K M | BD | CG | CG | | DG | DG | DG | ED | ED | ED | ED | EG | FK | FS | FS | FL | LC | LC | LC | LB | LB | LB | LB | LB | LB | GB | GB | GB | GB | GH | GK | GK |
| 1,800 pF | 182 | J K M | | CG | | | DG | DG | DG | ED | ED | ED | ED | EG | FK | FS | FS | FL | LC | LC | LC | LB | LB | LB | LB | LB | LB | GB | GD | GD | GD | GH | GK | GK |
| 2,200 pF | 222 | J K M | | CG | | | DG | DG | DG | ED | ED | ED | ED | EG | FK | FL | FL | FL | LC | LA | LA | LA | LA | LA | LA | LA | LA | GB | GH | GH | GH | GH | GK | GK |
| 2,700 pF | 272 | J K M | | CG | | | DG | DG | DG | ED | ED | ED | ED | EG | FS | FL | FL | FL | LC | LA | LA | LA | LB | LB | LB | LB | LB | GB | GB | GB | GH | GK | GM | GM |
| 3,300 pF | 332 | J K M | | CG | | | DG | DG | DG | ED | ED | ED | ED | EG | FS | FL | FL | FL | LC | LA | LA | LA | LB | LB | LB | LB | LB | GB | GB | GB | GH | GK | GM | GM |
| 3,900 pF | 392 | J K M | | CG | | | DG | DG | DG | ED | ED | ED | ED | EG | FL | FL | FL | FL | LA | LA | LA | LB | LB | LB | LB | LB | LB | GB | GB | GB | GH | GM | GO | GO |
| 4,700 pF | 472 | J K M | | | | DG | DG | DG | ED | ED | ED | ED | ED | EG | FL | FL | FL | FL | LA | LA | LA | LA | LB | LB | LB | LB | LB | GH | GH | GH | GH | GH | GO | GO |
| 5,600 pF | 562 | J K M | | | | DG | DG | | ED | EF | EF | EF | EF | FL | FL | FL | FM | FK | LA | LB | LB | LB | LB | LB | LB | LB | GH | GH | GH | GK | GK | | | |
| 6,800 pF | 682 | J K M | | | | DG | DG | | ED | EF | EF | EF | EF | FL | FL | FL | FM | FS | LA | LB | LB | LB | LB | LB | LB | LB | GH | GH | GH | GK | GM | | | |
| 8,200 pF | 822 | J K M | | | | DG | DG | | ED | EF | EF | EF | EF | FL | FL | FL | FK | | LA | LB | LB | LB | LB | LB | LB | LB | GH | GH | GH | GK | GM | | | |
| 10,000 pF | 103 | J K M | | | | DG | DG | | ED | EG | EG | EG | EG | FL | FL | FL | FK | | LA | LB | LB | LB | LB | LB | LB | LB | GH | GH | GH | GK | GO | | | |
| 12,000 pF | 123 | J K M | | | | DG | DG | | ED | EJ | EJ | EJ | EJ | FL | FL | FL | FK | | LA | LC | LC | LB | | | | | GB | GK | GK | GK | | | | |
| Cap | Cap Code | Rated Voltage (VDC) | 500 | 500 | 630 | 1000 | 500 | 630 | 1000 | 500 | 630 | 1000 | 1500 | 2000 | 500 | 630 | 1000 | 1500 | 2000 | 500 | 630 | 1000 | 1500 | 2000 | 2500 | 3000 | 500 | 630 | 1000 | 1500 | 2000 | 2500 | 3000 | |
| Cap | Cap Code | | | | | | | | | | | | | | | | | | | | | | | | | | | | | | | | | |

Surface Mount Multilayer Ceramic Chip Capacitors (SMD MLCCs)
High Voltage X7R Dielectric, 500 – 3,000 VDC (Automotive Grade)

Table 1B – Capacitance Range/Selection Waterfall (1825 – 2225 Case Sizes) cont.

| Capacitance | Cap Code | Case Size/ Series | | | C1825C | | | | | | | | C2220C | | | | | | | | C2225C | | | | | | | |
|-------------|----------|-----------------------|---|---|---|-----|------|------|------|------|------|-----|--------|------|------|------|------|------|-----|-----|--------|------|------|------|------|--|--|--|
| | | Voltage Code | | | C | B | D | F | G | Z | H | C | B | D | F | G | Z | H | C | B | D | F | G | Z | H | | | |
| | | Rated Voltage (VDC) | | | 500 | 630 | 1000 | 1500 | 2000 | 2500 | 3000 | 500 | 630 | 1000 | 1500 | 2000 | 2500 | 3000 | 500 | 630 | 1000 | 1500 | 2000 | 2500 | 3000 | | | |
| | | Capacitance Tolerance | | | Product Availability and Chip Thickness Codes – See Table 2 for Chip Thickness Dimensions | | | | | | | | | | | | | | | | | | | | | | | |
| 1,000 pF | 102 | J | K | M | HG | HG | HG | HG | HG | HG | HG | JE | JK | JK | JK | JK | JK | JK | KE | KE | KE | KF | KE | KF | KF | | | |
| 1,200 pF | 122 | J | K | M | HG | HG | HG | HG | HG | HG | HG | JE | JK | JK | JK | JK | JK | JK | KE | KE | KE | KF | KE | KF | KF | | | |
| 1,500 pF | 152 | J | K | M | HG | HG | HG | HG | HG | HG | HG | JE | JK | JK | JK | JK | JK | JK | KE | KE | KE | KF | KE | KF | KF | | | |
| 1,800 pF | 182 | J | K | M | HE | HE | HE | HE | HE | HG | HG | JE | JK | JK | JK | JK | JK | JK | KE | KE | KE | KF | KE | KF | KF | | | |
| 2,200 pF | 222 | J | K | M | HE | HE | HE | HE | HE | HG | HG | JE | JK | JK | JK | JK | JK | JK | KE | KE | KE | KF | KE | KF | KF | | | |
| 2,700 pF | 272 | J | K | M | HE | HE | HE | HE | HE | HG | | JK | JK | JK | JE | JE | JK | JK | KE | KE | KE | KE | KE | KF | KE | | | |
| 3,300 pF | 332 | J | K | M | HE | HE | HE | HE | HE | HG | | JK | JK | JK | JE | JE | JK | JE | KE | KE | KE | KE | KE | KF | KE | | | |
| 3,900 pF | 392 | J | K | M | HE | HE | HE | HE | HE | HG | | JK | JK | JK | JE | JE | JK | JE | KE | KF | KF | KE | KE | KF | KE | | | |
| 4,700 pF | 472 | J | K | M | HE | HE | HE | HE | HE | HG | | JK | JK | JK | JE | JE | JK | JE | KE | KF | KF | KE | KE | KF | KE | | | |
| 5,600 pF | 562 | J | K | M | HE | HE | HE | HE | HE | HG | | JK | JK | JK | JE | JK | JE | JE | KE | KF | KF | KE | KE | KF | KE | | | |
| 6,800 pF | 682 | J | K | M | HE | HE | HE | HE | HE | HJ | | JK | JE | JE | JE | JK | JE | JE | KE | KF | KF | KE | KE | KF | KE | | | |
| 8,200 pF | 822 | J | K | M | HE | HE | HE | HE | HE | HJ | | JK | JE | JE | JE | JK | JK | JK | KF | KE | KE | KE | KF | KF | KF | | | |
| 10,000 pF | 103 | J | K | M | HE | HE | HE | HE | HE | HJ | HK | JE | JE | JE | JE | JL | JL | JL | KF | KE | KE | KE | KF | KH | KH | | | |
| 12,000 pF | 123 | J | K | M | HE | HE | HE | HG | HJ | | | JE | JK | JK | JK | JL | JL | JL | KE | KE | KE | KE | KF | KH | KH | | | |
| 15,000 pF | 153 | J | K | M | HE | HE | HE | HG | HK | | | JE | JK | JK | JK | JL | JN | JN | KE | KE | KE | KE | KF | KJ | KJ | | | |
| 18,000 pF | 183 | J | K | M | HE | HE | HE | HG | | | | JE | JK | JK | JK | JN | | | KE | KE | KE | KE | KH | | | | | |
| 22,000 pF | 223 | J | K | M | HE | HG | HG | HG | | | | JE | JK | JK | JK | JN | | | KE | KF | KF | KF | KJ | | | | | |
| 27,000 pF | 273 | J | K | M | HE | HG | HG | HG | | | | JE | JK | JK | JK | | | | KE | KF | KF | KF | KJ | | | | | |
| 33,000 pF | 333 | J | K | M | HE | HG | HG | HE | | | | JE | JK | JK | JK | | | | KE | KF | KF | KF | | | | | | |
| 39,000 pF | 393 | J | K | M | HE | HG | HG | HG | | | | JE | JK | JK | JE | | | | KE | KF | KF | KF | | | | | | |
| 47,000 pF | 473 | J | K | M | HE | HG | HG | HJ | | | | JE | JK | JK | JK | | | | KE | KF | KF | KF | | | | | | |
| 56,000 pF | 563 | J | K | M | HE | HG | HG | HJ | | | | JE | JE | JE | JL | | | | KE | KF | KF | KF | | | | | | |
| 68,000 pF | 683 | J | K | M | HG | HJ | HJ | HK | | | | JE | JK | JK | JL | | | | KE | KF | KF | KJ | | | | | | |
| 82,000 pF | 823 | J | K | M | HG | HJ | HJ | | | | | JE | JL | JL | JN | | | | KE | KF | KF | KJ | | | | | | |
| 0.10 µF | 104 | J | K | M | HG | HK | HK | | | | | JE | JN | JN | | | | | KE | KH | KH | KJ | | | | | | |
| 0.12 µF | 124 | J | K | M | HG | HE | | | | | | JE | JN | JN | | | | | KE | KH | KH | | | | | | | |
| 0.15 µF | 154 | J | K | M | HG | HE | | | | | | JK | JE | | | | | | KF | KJ | KJ | | | | | | | |
| 0.18 µF | 184 | J | K | M | HG | HG | | | | | | JK | JE | | | | | | KF | KE | | | | | | | | |
| 0.22 µF | 224 | J | K | M | HG | HJ | | | | | | JK | JK | | | | | | KF | KF | | | | | | | | |
| 0.27 µF | 274 | J | K | M | HJ | HJ | | | | | | JK | JL | | | | | | KF | KH | | | | | | | | |
| 0.33 µF | 334 | J | K | M | HJ | | | | | | | JL | JN | | | | | | KF | KH | | | | | | | | |
| 0.39 µF | 394 | J | K | M | HK | | | | | | | JN | | | | | | | KH | KJ | | | | | | | | |
| 0.47 µF | 474 | J | K | M | | | | | | | | JN | | | | | | | KH | KJ | | | | | | | | |
| 0.56 µF | 564 | J | K | M | | | | | | | | | | | | | | | KJ | | | | | | | | | |
| 0.56 µF | 564 | J | K | M | | | | | | | | | | | | | | | | | | | | | | | | |
| Capacitance | Cap Code | Rated Voltage (VDC) | | | 500 | 630 | 1000 | 1500 | 2000 | 2500 | 3000 | 500 | 630 | 1000 | 1500 | 2000 | 2500 | 3000 | 500 | 630 | 1000 | 1500 | 2000 | 2500 | 3000 | | | |
| | | Voltage Code | | | C | B | D | F | G | Z | H | C | B | D | F | G | Z | H | C | B | D | F | G | Z | H | | | |
| | | Case Size/Series | | | C1825C | | | | | | | | C2220C | | | | | | | | C2225C | | | | | | | |

KEMET reserves the right to substitute product with an improved temperature characteristic, tighter capacitance tolerance and/or higher voltage capability within the same form factor (configuration and dimensions).

Surface Mount Multilayer Ceramic Chip Capacitors (SMD MLCCs)
High Voltage X7R Dielectric, 500 – 3,000 VDC (Automotive Grade)

Table 2 – Chip Thickness/Tape & Reel Packaging Quantities

| Thickness Code | Case Size ¹ | Thickness ± Range (mm) | Paper Quantity | | Plastic Quantity | |
|----------------|------------------------|------------------------|-----------------------------|----------|------------------|----------|
| | | | 7" Reel | 13" Reel | 7" Reel | 13" Reel |
| BB | 0402 | 0.50 ± 0.05 | 10,000 | 50,000 | 0 | 0 |
| BD | 0402 | 0.55 ± 0.05 | 10,000 | 50,000 | 0 | 0 |
| CG | 0603 | 0.80 ± 0.10* | 4,000 | 15,000 | 0 | 0 |
| DG | 0805 | 1.25 ± 0.15 | 0 | 0 | 2,500 | 10,000 |
| ED | 1206 | 1.00 ± 0.10 | 0 | 0 | 2,500 | 10,000 |
| EF | 1206 | 1.20 ± 0.15 | 0 | 0 | 2,500 | 10,000 |
| EG | 1206 | 1.60 ± 0.15 | 0 | 0 | 2,000 | 8,000 |
| EJ | 1206 | 1.70 ± 0.20 | 0 | 0 | 2,000 | 8,000 |
| FG | 1210 | 1.25 ± 0.15 | 0 | 0 | 2,500 | 10,000 |
| FL | 1210 | 1.40 ± 0.15 | 0 | 0 | 2,000 | 8,000 |
| FH | 1210 | 1.55 ± 0.15 | 0 | 0 | 2,000 | 8,000 |
| FM | 1210 | 1.70 ± 0.20 | 0 | 0 | 2,000 | 8,000 |
| FK | 1210 | 2.10 ± 0.20 | 0 | 0 | 2,000 | 8,000 |
| FS | 1210 | 2.50 ± 0.30 | 0 | 0 | 1,000 | 4,000 |
| LE | 1808 | 1.00 ± 0.10 | 0 | 0 | 2,500 | 10,000 |
| LA | 1808 | 1.40 ± 0.15 | 0 | 0 | 1,000 | 4,000 |
| LB | 1808 | 1.60 ± 0.15 | 0 | 0 | 1,000 | 4,000 |
| LC | 1808 | 2.00 ± 0.15 | 0 | 0 | 1,000 | 4,000 |
| GB | 1812 | 1.00 ± 0.10 | 0 | 0 | 1,000 | 4,000 |
| GC | 1812 | 1.10 ± 0.10 | 0 | 0 | 1,000 | 4,000 |
| GE | 1812 | 1.30 ± 0.10 | 0 | 0 | 1,000 | 4,000 |
| GH | 1812 | 1.40 ± 0.15 | 0 | 0 | 1,000 | 4,000 |
| GF | 1812 | 1.50 ± 0.10 | 0 | 0 | 1,000 | 4,000 |
| GK | 1812 | 1.60 ± 0.20 | 0 | 0 | 1,000 | 4,000 |
| GJ | 1812 | 1.70 ± 0.15 | 0 | 0 | 1,000 | 4,000 |
| GN | 1812 | 1.70 ± 0.20 | 0 | 0 | 1,000 | 4,000 |
| GL | 1812 | 1.90 ± 0.20 | 0 | 0 | 500 | 2,000 |
| GM | 1812 | 2.00 ± 0.20 | 0 | 0 | 500 | 2,000 |
| GS | 1812 | 2.10 ± 0.20 | 0 | 0 | 500 | 2,000 |
| GO | 1812 | 2.50 ± 0.20 | 0 | 0 | 500 | 2,000 |
| HE | 1825 | 1.40 ± 0.15 | 0 | 0 | 1,000 | 4,000 |
| HG | 1825 | 1.60 ± 0.20 | 0 | 0 | 1,000 | 4,000 |
| HJ | 1825 | 2.00 ± 0.20 | 0 | 0 | 500 | 2,000 |
| HK | 1825 | 2.50 ± 0.20 | 0 | 0 | 500 | 2,000 |
| JE | 2220 | 1.40 ± 0.15 | 0 | 0 | 1,000 | 4,000 |
| JK | 2220 | 1.60 ± 0.20 | 0 | 0 | 1,000 | 4,000 |
| JL | 2220 | 2.00 ± 0.20 | 0 | 0 | 500 | 2,000 |
| JN | 2220 | 2.50 ± 0.20 | 0 | 0 | 500 | 2,000 |
| KE | 2225 | 1.40 ± 0.15 | 0 | 0 | 1,000 | 4,000 |
| KF | 2225 | 1.60 ± 0.20 | 0 | 0 | 1,000 | 4,000 |
| KH | 2225 | 2.00 ± 0.20 | 0 | 0 | 500 | 2,000 |
| KJ | 2225 | 2.50 ± 0.20 | 0 | 0 | 500 | 2,000 |
| Thickness Code | Case Size ¹ | Thickness ± Range (mm) | 7" Reel | 13" Reel | 7" Reel | 13" Reel |
| | | | Paper Quantity ¹ | | Plastic Quantity | |

Package quantity based on finished chip thickness specifications.

Table 3 – Chip Capacitor Land Pattern Design Recommendations per IPC–7351

| EIA Size Code | Metric Size Code | Density Level A: Maximum (Most) Land Protrusion (mm) | | | | | Density Level B: Median (Nominal) Land Protrusion (mm) | | | | | Density Level C: Minimum (Least) Land Protrusion (mm) | | | | |
|---------------|------------------|--|------|------|------|------|--|------|------|------|------|---|------|------|------|------|
| | | C | Y | X | V1 | V2 | C | Y | X | V1 | V2 | C | Y | X | V1 | V2 |
| 0402 | 1005 | 0.50 | 0.72 | 0.72 | 2.20 | 1.20 | 0.45 | 0.62 | 0.62 | 1.90 | 1.00 | 0.40 | 0.52 | 0.52 | 1.60 | 0.80 |
| 0603 | 1608 | 0.90 | 1.15 | 1.10 | 4.00 | 2.10 | 0.80 | 0.95 | 1.00 | 3.10 | 1.50 | 0.60 | 0.75 | 0.90 | 2.40 | 1.20 |
| 0805 | 2012 | 1.00 | 1.35 | 1.55 | 4.40 | 2.60 | 0.90 | 1.15 | 1.45 | 3.50 | 2.00 | 0.75 | 0.95 | 1.35 | 2.80 | 1.70 |
| 1206 | 3216 | 1.60 | 1.35 | 1.90 | 5.60 | 2.90 | 1.50 | 1.15 | 1.80 | 4.70 | 2.30 | 1.40 | 0.95 | 1.70 | 4.00 | 2.00 |
| 1210 | 3225 | 1.60 | 1.35 | 2.80 | 5.65 | 3.80 | 1.50 | 1.15 | 2.70 | 4.70 | 3.20 | 1.40 | 0.95 | 2.60 | 4.00 | 2.90 |
| 1808 | 4520 | 2.30 | 1.75 | 2.30 | 7.40 | 3.30 | 2.20 | 1.55 | 2.20 | 6.50 | 2.70 | 2.10 | 1.35 | 2.10 | 5.80 | 2.40 |
| 1812 | 4532 | 2.15 | 1.60 | 3.60 | 6.90 | 4.60 | 2.05 | 1.40 | 3.50 | 6.00 | 4.00 | 1.95 | 1.20 | 3.40 | 5.30 | 3.70 |
| 1825 | 4564 | 2.15 | 1.60 | 6.90 | 6.90 | 7.90 | 2.05 | 1.40 | 6.80 | 6.00 | 7.30 | 1.95 | 1.20 | 6.70 | 5.30 | 7.00 |
| 2220 | 5650 | 2.75 | 1.70 | 5.50 | 8.20 | 6.50 | 2.65 | 1.50 | 5.40 | 7.30 | 5.90 | 2.55 | 1.30 | 5.30 | 6.60 | 5.60 |
| 2225 | 5664 | 2.70 | 1.70 | 6.90 | 8.10 | 7.90 | 2.60 | 1.50 | 6.80 | 7.20 | 7.30 | 2.50 | 1.30 | 6.70 | 6.50 | 7.00 |

Density Level A: For low-density product applications. Recommended for wave solder applications and provides a wider process window for reflow solder processes. KEMET only recommends wave soldering of EIA 0603, 0805 and 1206 case sizes.

Density Level B: For products with a moderate level of component density. Provides a robust solder attachment condition for reflow solder processes.

Density Level C: For high component density product applications. Before adapting the minimum land pattern variations the user should perform qualification testing based on the conditions outlined in IPC Standard 7351 (IPC–7351).

Image below based on Density Level B for an EIA 1210 case size.

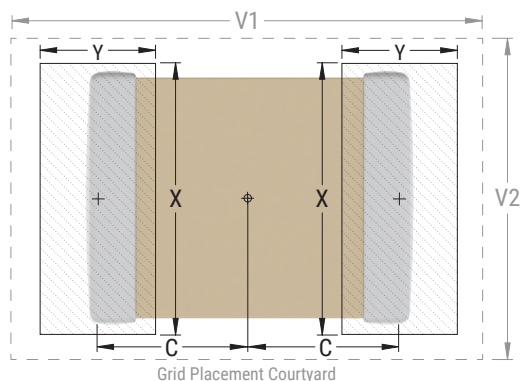

Surface Mount Multilayer Ceramic Chip Capacitors (SMD MLCCs) High Voltage X7R Dielectric, 500 – 3,000 VDC (Automotive Grade)

Soldering Process

Recommended Soldering Technique:

- Solder wave or solder reflow for EIA case sizes 0603, 0805 and 1206
- All other EIA case sizes are limited to solder reflow only

Recommended Reflow Soldering Profile:

The KEMET families of surface mount multilayer ceramic capacitors (SMD MLCCs) are compatible with wave (single or dual), convection, IR or vapor phase reflow techniques. Preheating of these components is recommended to avoid extreme thermal stress. The KEMET recommended profile conditions for convection and IR reflow reflect the profile conditions of the IPC/J-STD-020 standard for moisture sensitivity testing. These devices can safely withstand a maximum of three reflow passes at these conditions.

| Profile Feature | Termination Finish | |
|---|--------------------|--------------------|
| | SnPb | 100% Matte Sn |
| Preheat/Soak | | |
| Temperature Minimum (T_{Smin}) | 100°C | 150°C |
| Temperature Maximum (T_{Smax}) | 150°C | 200°C |
| Time (t_s) from T_{Smin} to T_{Smax} | 60 – 120 seconds | 60 – 120 seconds |
| Ramp-Up Rate (T_L to T_p) | 3°C/second maximum | 3°C/second maximum |
| Liquidous Temperature (T_L) | 183°C | 217°C |
| Time Above Liquidous (t_L) | 60 – 150 seconds | 60 – 150 seconds |
| Peak Temperature (T_p) | 235°C | 260°C |
| Time Within 5°C of Maximum Peak Temperature (t_p) | 20 seconds maximum | 30 seconds maximum |
| Ramp-Down Rate (T_p to T_L) | 6°C/second maximum | 6°C/second maximum |
| Time 25°C to Peak Temperature | 6 minutes maximum | 8 minutes maximum |

Note: All temperatures refer to the center of the package, measured on the capacitor body surface that is facing up during assembly reflow.

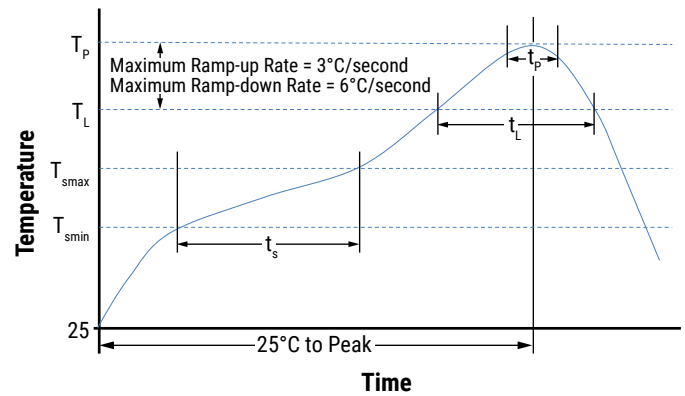

Storage and Handling

Ceramic chip capacitors should be stored in normal working environments. While the chips themselves are quite robust in other environments, solderability will be degraded by exposure to high temperatures, high humidity, corrosive atmospheres, and long term storage. In addition, packaging materials will be degraded by high temperature – reels may soften or warp and tape peel force may increase. KEMET recommends that maximum storage temperature not exceed 40°C and maximum storage humidity not exceed 70% relative humidity. Temperature fluctuations should be minimized to avoid condensation on the parts and atmospheres should be free of chlorine and sulfur bearing compounds. For optimized solderability chip stock should be used promptly, preferably within 1.5 years of receipt.

Surface Mount Multilayer Ceramic Chip Capacitors (SMD MLCCs) High Voltage X7R Dielectric, 500 – 3,000 VDC (Automotive Grade)

Construction

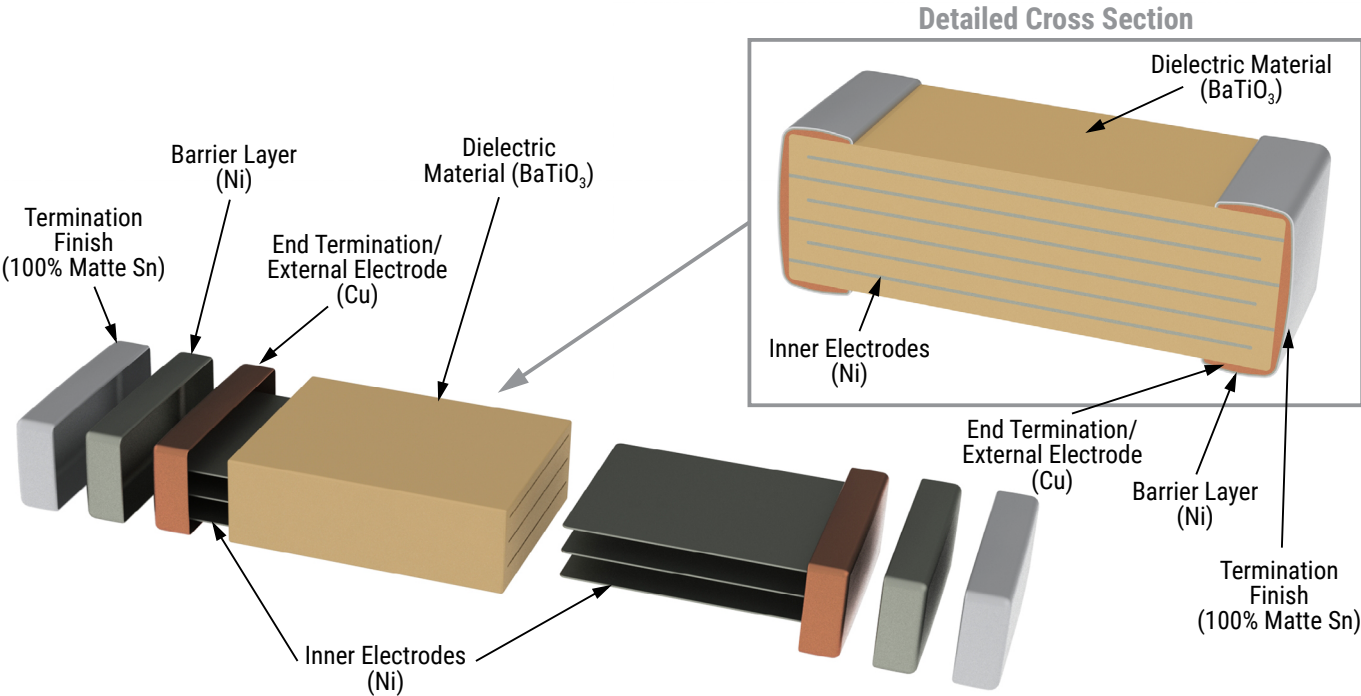

Surface Mount Multilayer Ceramic Chip Capacitors (SMD MLCCs) High Voltage X7R Dielectric, 500 – 3,000 VDC (Automotive Grade)

Capacitor Marking (Optional)

These surface mount multilayer ceramic capacitors are normally supplied unmarked. If required, they can be marked as an extra cost option. Marking is available on most KEMET devices, but must be requested using the correct ordering code identifier(s). If this option is requested, two sides of the ceramic body will be laser marked with a “K” to identify KEMET, followed by two characters (per EIA-198 - see table below) to identify the capacitance value. EIA 0603 case size devices are limited to the “K” character only.

Laser marking option is not available on:

- COG, ultra stable X8R and Y5V dielectric devices.
- EIA 0402 case size devices.
- EIA 0603 case size devices with flexible termination option.
- KPS commercial and automotive grade stacked devices.
- X7R dielectric products in capacitance values outlined below.

Marking appears in legible contrast. Illustrated below is an example of an MLCC with laser marking of “KA8”, which designates a KEMET device with rated capacitance of 100 μ F. Orientation of marking is vendor optional.

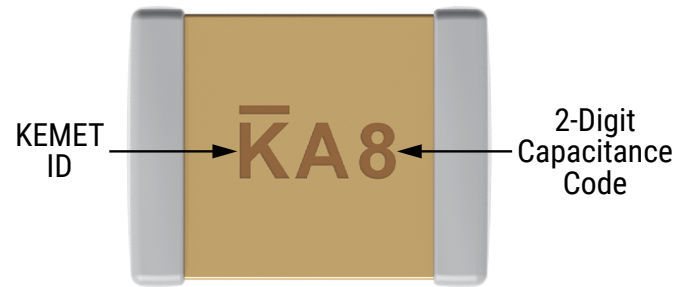

| EIA Case Size | Metric Size Code | Capacitance |
|---------------|------------------|----------------------|
| 0603 | 1608 | ≤ 170 pF |
| 0805 | 2012 | ≤ 150 pF |
| 1206 | 3216 | ≤ 910 pF |
| 1210 | 3225 | $\leq 2,000$ pF |
| 1808 | 4520 | $\leq 3,900$ pF |
| 1812 | 4532 | $\leq 6,700$ pF |
| 1825 | 4564 | ≤ 0.018 μ F |
| 2220 | 5650 | ≤ 0.027 μ F |
| 2225 | 5664 | ≤ 0.033 μ F |

Surface Mount Multilayer Ceramic Chip Capacitors (SMD MLCCs)
High Voltage X7R Dielectric, 500 – 3,000 VDC (Automotive Grade)

Capacitor Marking (Optional) cont.

| Capacitance (pF) For Various Alpha/Numeral Identifiers | | | | | | | | | | |
|--|------------------|-----|----|-----|-------|--------|---------|-----------|------------|-------------|
| Alpha Character | Numeral | | | | | | | | | |
| | 9 | 0 | 1 | 2 | 3 | 4 | 5 | 6 | 7 | 8 |
| | Capacitance (pF) | | | | | | | | | |
| A | 0.10 | 1.0 | 10 | 100 | 1,000 | 10,000 | 100,000 | 1,000,000 | 10,000,000 | 100,000,000 |
| B | 0.11 | 1.1 | 11 | 110 | 1,100 | 11,000 | 110,000 | 1,100,000 | 11,000,000 | 110,000,000 |
| C | 0.12 | 1.2 | 12 | 120 | 1,200 | 12,000 | 120,000 | 1,200,000 | 12,000,000 | 120,000,000 |
| D | 0.13 | 1.3 | 13 | 130 | 1,300 | 13,000 | 130,000 | 1,300,000 | 13,000,000 | 130,000,000 |
| E | 0.15 | 1.5 | 15 | 150 | 1,500 | 15,000 | 150,000 | 1,500,000 | 15,000,000 | 150,000,000 |
| F | 0.16 | 1.6 | 16 | 160 | 1,600 | 16,000 | 160,000 | 1,600,000 | 16,000,000 | 160,000,000 |
| G | 0.18 | 1.8 | 18 | 180 | 1,800 | 18,000 | 180,000 | 1,800,000 | 18,000,000 | 180,000,000 |
| H | 0.20 | 2.0 | 20 | 200 | 2,000 | 20,000 | 200,000 | 2,000,000 | 20,000,000 | 200,000,000 |
| J | 0.22 | 2.2 | 22 | 220 | 2,200 | 22,000 | 220,000 | 2,200,000 | 22,000,000 | 220,000,000 |
| K | 0.24 | 2.4 | 24 | 240 | 2,400 | 24,000 | 240,000 | 2,400,000 | 24,000,000 | 240,000,000 |
| L | 0.27 | 2.7 | 27 | 270 | 2,700 | 27,000 | 270,000 | 2,700,000 | 27,000,000 | 270,000,000 |
| M | 0.30 | 3.0 | 30 | 300 | 3,000 | 30,000 | 300,000 | 3,000,000 | 30,000,000 | 300,000,000 |
| N | 0.33 | 3.3 | 33 | 330 | 3,300 | 33,000 | 330,000 | 3,300,000 | 33,000,000 | 330,000,000 |
| P | 0.36 | 3.6 | 36 | 360 | 3,600 | 36,000 | 360,000 | 3,600,000 | 36,000,000 | 360,000,000 |
| Q | 0.39 | 3.9 | 39 | 390 | 3,900 | 39,000 | 390,000 | 3,900,000 | 39,000,000 | 390,000,000 |
| R | 0.43 | 4.3 | 43 | 430 | 4,300 | 43,000 | 430,000 | 4,300,000 | 43,000,000 | 430,000,000 |
| S | 0.47 | 4.7 | 47 | 470 | 4,700 | 47,000 | 470,000 | 4,700,000 | 47,000,000 | 470,000,000 |
| T | 0.51 | 5.1 | 51 | 510 | 5,100 | 51,000 | 510,000 | 5,100,000 | 51,000,000 | 510,000,000 |
| U | 0.56 | 5.6 | 56 | 560 | 5,600 | 56,000 | 560,000 | 5,600,000 | 56,000,000 | 560,000,000 |
| V | 0.62 | 6.2 | 62 | 620 | 6,200 | 62,000 | 620,000 | 6,200,000 | 62,000,000 | 620,000,000 |
| W | 0.68 | 6.8 | 68 | 680 | 6,800 | 68,000 | 680,000 | 6,800,000 | 68,000,000 | 680,000,000 |
| X | 0.75 | 7.5 | 75 | 750 | 7,500 | 75,000 | 750,000 | 7,500,000 | 75,000,000 | 750,000,000 |
| Y | 0.82 | 8.2 | 82 | 820 | 8,200 | 82,000 | 820,000 | 8,200,000 | 82,000,000 | 820,000,000 |
| Z | 0.91 | 9.1 | 91 | 910 | 9,100 | 91,000 | 910,000 | 9,100,000 | 91,000,000 | 910,000,000 |
| a | 0.25 | 2.5 | 25 | 250 | 2,500 | 25,000 | 250,000 | 2,500,000 | 25,000,000 | 250,000,000 |
| b | 0.35 | 3.5 | 35 | 350 | 3,500 | 35,000 | 350,000 | 3,500,000 | 35,000,000 | 350,000,000 |
| d | 0.40 | 4.0 | 40 | 400 | 4,000 | 40,000 | 400,000 | 4,000,000 | 40,000,000 | 400,000,000 |
| e | 0.45 | 4.5 | 45 | 450 | 4,500 | 45,000 | 450,000 | 4,500,000 | 45,000,000 | 450,000,000 |
| f | 0.50 | 5.0 | 50 | 500 | 5,000 | 50,000 | 500,000 | 5,000,000 | 50,000,000 | 500,000,000 |
| m | 0.60 | 6.0 | 60 | 600 | 6,000 | 60,000 | 600,000 | 6,000,000 | 60,000,000 | 600,000,000 |
| n | 0.70 | 7.0 | 70 | 700 | 7,000 | 70,000 | 700,000 | 7,000,000 | 70,000,000 | 700,000,000 |
| t | 0.80 | 8.0 | 80 | 800 | 8,000 | 80,000 | 800,000 | 8,000,000 | 80,000,000 | 800,000,000 |
| y | 0.90 | 9.0 | 90 | 900 | 9,000 | 90,000 | 900,000 | 9,000,000 | 90,000,000 | 900,000,000 |

Surface Mount Multilayer Ceramic Chip Capacitors (SMD MLCCs) High Voltage X7R Dielectric, 500 – 3,000 VDC (Automotive Grade)

Tape & Reel Packaging Information

KEMET offers multilayer ceramic chip capacitors packaged in 8, 12 and 16 mm tape on 7" and 13" reels in accordance with EIA Standard 481. This packaging system is compatible with all tape-fed automatic pick and place systems. See Table 2 for details on reeling quantities for commercial chips.



Table 5 – Carrier Tape Configuration, Embossed Plastic & Punched Paper (mm)

| EIA Case Size | Tape Size (W)* | Embossed Plastic | | Punched Paper | |
|-------------------|----------------|--------------------------|----------|--------------------------|----------|
| | | 7" Reel | 13" Reel | 7" Reel | 13" Reel |
| | | Pitch (P ₁)* | | Pitch (P ₁)* | |
| 01005 – 0402 | 8 | | | 2 | 2 |
| 0603 | 8 | | | 4 | 4 |
| 0805 | 8 | 4 | 4 | 4 | 4 |
| 1206 – 1210 | 8 | 4 | 4 | 4 | 4 |
| 1805 – 1808 | 12 | 4 | 4 | | |
| ≥ 1812 | 12 | 8 | 8 | | |
| KPS 1210 | 12 | 8 | 8 | | |
| KPS 1812 and 2220 | 16 | 12 | 12 | | |
| Array 0612 | 8 | 4 | 4 | | |

*Refer to Figures 1 and 2 for W and P₁ carrier tape reference locations.

*Refer to Tables 6 and 7 for tolerance specifications.

Surface Mount Multilayer Ceramic Chip Capacitors (SMD MLCCs)
High Voltage X7R Dielectric, 500 – 3,000 VDC (Automotive Grade)

Figure 1 – Embossed (Plastic) Carrier Tape Dimensions



Table 6 – Embossed (Plastic) Carrier Tape Dimensions
Metric will govern

| Constant Dimensions – Millimeters (Inches) | | | | | | | | | |
|--|---------------------------------------|----------------------------------|------------------------------|-----------------------------|------------------------------|---------------------------|----------------------------------|--|---------------------------|
| Tape Size | D ₀ | D ₁ Minimum Note 1 | E ₁ | P ₀ | P ₂ | R Reference Note 2 | S ₁ Minimum Note 3 | T Maximum | T ₁ Maximum |
| 8 mm | 1.5 +0.10/-0.0 (0.059 +0.004/-0.0) | 1.0 (0.039) | 1.75 ±0.10 (0.069 ±0.004) | 4.0 ±0.10 (0.157 ±0.004) | 2.0 ±0.05 (0.079 ±0.002) | 25.0 (0.984) | 0.600 (0.024) | 0.600 (0.024) | 0.100 (0.004) |
| 12 mm | | 1.5 (0.059) | | | | | | | |
| 16 mm | | | | | | | | | |
| Variable Dimensions – Millimeters (Inches) | | | | | | | | | |
| Tape Size | Pitch | B ₁ Maximum Note 4 | E ₂ Minimum | F | P ₁ | T ₂ Maximum | W Maximum | A ₀ , B ₀ & K ₀ | |
| 8 mm | Single (4 mm) | 4.35 (0.171) | 6.25 (0.246) | 3.5 ±0.05 (0.138 ±0.002) | 4.0 ±0.10 (0.157 ±0.004) | 2.5 (0.098) | 8.3 (0.327) | Note 5 | |
| 12 mm | Single (4 mm) and double (8 mm) | 8.2 (0.323) | 10.25 (0.404) | 5.5 ±0.05 (0.217 ±0.002) | 8.0 ±0.10 (0.315 ±0.004) | 4.6 (0.181) | 12.3 (0.484) | | |
| 16 mm | Triple (12 mm) | 12.1 (0.476) | 14.25 (0.561) | 7.5 ±0.05 (0.138 ±0.002) | 12.0 ±0.10 (0.157 ±0.004) | 4.6 (0.181) | 16.3 (0.642) | | |

1. The embossment hole location shall be measured from the sprocket hole controlling the location of the embossment. Dimensions of the embossment location and the hole location shall be applied independently of each other.
2. The tape with or without components shall pass around R without damage (see Figure 6.)
3. If $S_1 < 1.0$ mm, there may not be enough area for a cover tape to be properly applied (see EIA Standard 481, paragraph 4.3, section b.)
4. B_1 dimension is a reference dimension for tape feeder clearance only.
5. The cavity defined by A_0 , B_0 and K_0 shall surround the component with sufficient clearance that:
 - (a) the component does not protrude above the top surface of the carrier tape.
 - (b) the component can be removed from the cavity in a vertical direction without mechanical restriction, after the top cover tape has been removed.
 - (c) rotation of the component is limited to 20° maximum for 8 and 12 mm tapes and 10° maximum for 16 mm tapes (see Figure 3.)
 - (d) lateral movement of the component is restricted to 0.5 mm maximum for 8 and 12 mm wide tape and to 1.0 mm maximum for 16 mm tape (see Figure 4.)
 - (e) for KPS product, A_0 and B_0 are measured on a plane 0.3 mm above the bottom of the pocket.
 - (f) see addendum in EIA Standard 481 for standards relating to more precise taping requirements.

Surface Mount Multilayer Ceramic Chip Capacitors (SMD MLCCs)
High Voltage X7R Dielectric, 500 – 3,000 VDC (Automotive Grade)

Figure 2 – Punched (Paper) Carrier Tape Dimensions



Table 7 – Punched (Paper) Carrier Tape Dimensions

Metric will govern

| Constant Dimensions – Millimeters (Inches) | | | | | | | |
|--|---------------------------------------|------------------------------|-----------------------------|-----------------------------|----------------------------|-----------------|--------------------|
| Tape Size | D_0 | E_1 | P_0 | P_2 | T_1 Maximum | G Minimum | R Reference Note 2 |
| 8 mm | 1.5 +0.10 -0.0 (0.059 +0.004 -0.0) | 1.75 ±0.10 (0.069 ±0.004) | 4.0 ±0.10 (0.157 ±0.004) | 2.0 ±0.05 (0.079 ±0.002) | 0.10 (0.004) maximum | 0.75 (0.030) | 25 (0.984) |
| Variable Dimensions – Millimeters (Inches) | | | | | | | |
| Tape Size | Pitch | E2 Minimum | F | P_1 | T Maximum | W Maximum | $A_0 B_0$ |
| 8 mm | Single (4 mm) | 6.25 (0.246) | 3.5 ±0.05 (0.138 ±0.002) | 4.0 ±0.10 (0.157 ±0.004) | 1.1 (0.043) | 8.3 (0.327) | Note 1 |

- The cavity defined by A_0 , B_0 and T shall surround the component with sufficient clearance that:
 - the component does not protrude beyond either surface of the carrier tape.
 - the component can be removed from the cavity in a vertical direction without mechanical restriction, after the top cover tape has been removed.
 - rotation of the component is limited to 20° maximum (see Figure 3.)
 - lateral movement of the component is restricted to 0.5 mm maximum (see Figure 4.)
 - see addendum in EIA Standard 481 for standards relating to more precise taping requirements.
- The tape with or without components shall pass around R without damage (see Figure 6.)

Packaging Information Performance Notes

- Cover Tape Break Force:** 1.0 kg minimum.
- Cover Tape Peel Strength:** The total peel strength of the cover tape from the carrier tape shall be:

| Tape Width | Peel Strength |
|--------------|----------------------------------|
| 8 mm | 0.1 to 1.0 newton (10 to 100 gf) |
| 12 and 16 mm | 0.1 to 1.3 newton (10 to 130 gf) |

The direction of the pull shall be opposite the direction of the carrier tape travel. The pull angle of the carrier tape shall be 165° to 180° from the plane of the carrier tape. During peeling, the carrier and/or cover tape shall be pulled at a velocity of 300 ±10 mm/minute.

- Labeling:** Bar code labeling (standard or custom) shall be on the side of the reel opposite the sprocket holes. Refer to EIA Standards 556 and 624.

Figure 3 – Maximum Component Rotation



Figure 4 – Maximum Lateral Movement

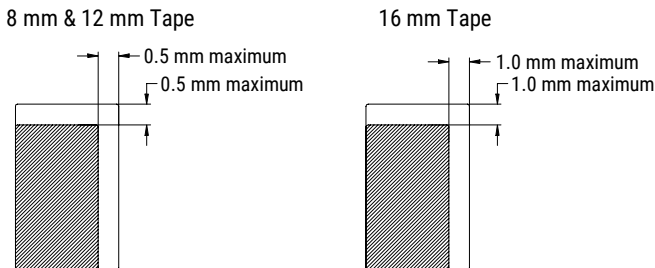

Figure 5 – Bending Radius



Surface Mount Multilayer Ceramic Chip Capacitors (SMD MLCCs)
High Voltage X7R Dielectric, 500 – 3,000 VDC (Automotive Grade)

Figure 6 – Reel Dimensions



Note: Drive spokes optional; if used, dimensions B and D shall apply.

Table 8 – Reel Dimensions

Metric will govern

| Constant Dimensions – Millimeters (Inches) | | | | |
|--|---|---------------------------------------|--|---|
| Tape Size | A | B Minimum | C | D Minimum |
| 8 mm | 178 ±0.20 (7.008 ±0.008) or 330 ±0.20 (13.000 ±0.008) | 1.5 (0.059) | 13.0 +0.5/-0.2 (0.521 +0.02/-0.008) | 20.2 (0.795) |
| 12 mm | | | | |
| 16 mm | | | | |
| Variable Dimensions – Millimeters (Inches) | | | | |
| Tape Size | N Minimum | W ₁ | W ₂ Maximum | W ₃ |
| 8 mm | 50 (1.969) | 8.4 +1.5/-0.0 (0.331 +0.059/-0.0) | 14.4 (0.567) | Shall accommodate tape width without interference |
| 12 mm | | 12.4 +2.0/-0.0 (0.488 +0.078/-0.0) | 18.4 (0.724) | |
| 16 mm | | 16.4 +2.0/-0.0 (0.646 +0.078/-0.0) | 22.4 (0.882) | |

Surface Mount Multilayer Ceramic Chip Capacitors (SMD MLCCs) High Voltage X7R Dielectric, 500 – 3,000 VDC (Automotive Grade)

Figure 7 – Tape Leader & Trailer Dimensions

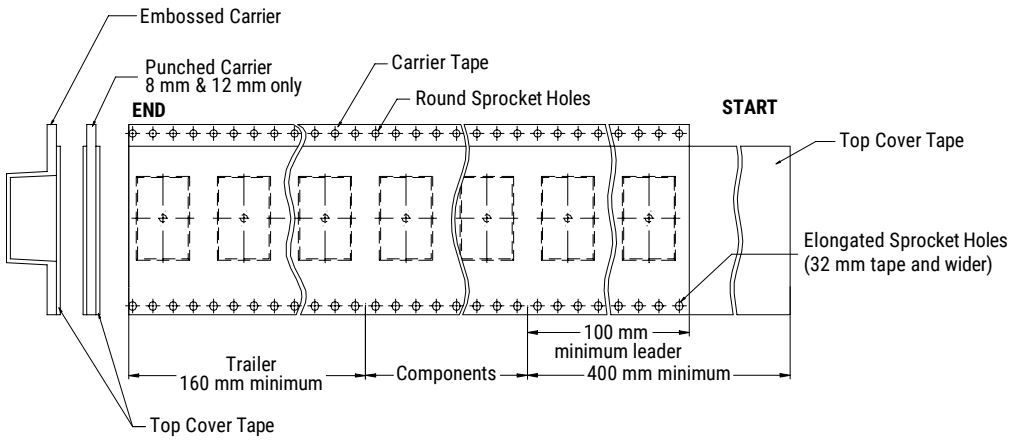

Figure 8 – Maximum Camber



Application Guide

Solder Fluxes and Cleaning

The use of water-soluble fluxes provides advantages of excellent solderability due to high activation. However, these fluxes contain organic acids that can induce arcing under high DC or AC voltages. Notable problem areas are underneath the MLCC where flux can be trapped between the ceramic material and PCB. It is therefore critical that PCBs are properly cleaned to remove all flux residue to maintain reliability.

Coating for High Voltage MLCCs

For MLCC ratings $\geq 1500V$, it is recommended to apply a conformal coating to MLCC to prevent surface arcing. To reduce possibility of inducing cracks in the MLCC, select a coating with thermal expansions close to that of the MLCC.

| Dielectric | CTE (ppm/°C) |
|-----------------------------|--------------|
| Class II BaTiO ₃ | 10.7 |
| Class I CaZrO ₃ | 9.8 |

Slits in PCB

It is recommended to apply a slit in the PCB under the MLCC to improve washing of flux residue that may get trapped underneath. In some cases, it is not possible to slit entirely through the PCB due to underlying metal planes. It is also acceptable to apply a recessed slit under the MLCC which will also promote cleaning.

- Recommended for case sizes ≥ 1206
- The width (w) of the slit should be 1mm
- Length of the slit should be as short as possible to prevent damaging the MLCC due to mechanical stress of the PCB.
- Slits also reduce the risk of solder balls under MLCC which decreased the creepage distance.

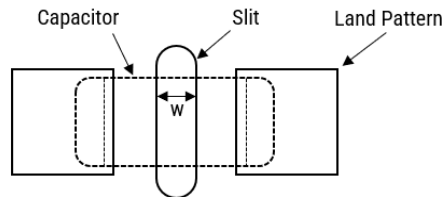

Solder Resist

If a slit cannot be applied as above, it is recommended to not use solder resist directly under the MLCC. The use of solder resist material reduces the distance between MLCC ceramic material and PCB thus making it difficult to clean.

Solder Balls

Improper reflow techniques and/or improper washing can induce solder balls under or adjacent to the MLCC. Solder balls reduce the creepage distance between the MLCC terminations and increase the risk of arcing or damage to the ceramic material. To reduce the risk of solder balls:

- Follow KEMET's solder recommendations as outlined in the datasheet.
- If performing a cleaning procedure, properly clean the PCB per KEMET's cleaning recommendations.
- Add slit to the PCB as shown above.

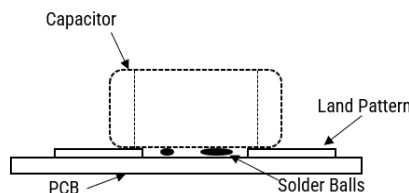

Surface Mount Multilayer Ceramic Chip Capacitors (SMD MLCCs) High Voltage X7R Dielectric, 500 – 3,000 VDC (Automotive Grade)

KEMET Electronics Corporation Sales Offices

For a complete list of our global sales offices, please visit <https://www.yageogroup.com/SalesResources/SalesOffices>

Disclaimer

YAGEO Corporation and its affiliates do not recommend the use of commercial or automotive grade products for high reliability applications or manned space flight.

All product specifications, statements, information and data (collectively, the "Information") in this datasheet are subject to change. The customer is responsible for checking and verifying the extent to which the Information contained in this publication is applicable to an order at the time the order is placed. All Information given herein is believed to be accurate and reliable, but it is presented without guarantee, warranty, or responsibility of any kind, expressed or implied.

Statements of suitability for certain applications are based on KEMET Electronics Corporation's ("KEMET") knowledge of typical operating conditions for such applications, but are not intended to constitute – and KEMET specifically disclaims – any warranty concerning suitability for a specific customer application or use. The Information is intended for use only by customers who have the requisite experience and capability to determine the correct products for their application. Any technical advice inferred from this Information or otherwise provided by KEMET with reference to the use of KEMET's products is given gratis, and KEMET assumes no obligation or liability for the advice given or results obtained.

Although KEMET designs and manufactures its products to the most stringent quality and safety standards, given the current state of the art, isolated component failures may still occur. Accordingly, customer applications which require a high degree of reliability or safety should employ suitable designs or other safeguards (such as installation of protective circuitry or redundancies) in order to ensure that the failure of an electrical component does not result in a risk of personal injury or property damage.

Although all product-related warnings, cautions and notes must be observed, the customer should not assume that all safety measures are indicated or that other measures may not be required.

KEMET is a registered trademark of KEMET Electronics Corporation.

Looking for pricing, stock, or lifecycle information?

Click below to explore more details on WIN SOURCE:

 [View C1812C472KGRACAUTO on WIN SOURCE](#)

 [Kemet Information](#)

Optimize Your Supply Chain with WIN SOURCE Solutions

-  Global Sourcing Solution
-  Obsolete Management
-  Cost Control Management
-  Shortage Management
-  Alternative Solution
-  Excess Inventory Management