



Is Now Part of



**ON Semiconductor®**

To learn more about ON Semiconductor, please visit our website at  
[www.onsemi.com](http://www.onsemi.com)

Please note: As part of the Fairchild Semiconductor integration, some of the Fairchild orderable part numbers will need to change in order to meet ON Semiconductor's system requirements. Since the ON Semiconductor product management systems do not have the ability to manage part nomenclature that utilizes an underscore (\_), the underscore (\_) in the Fairchild part numbers will be changed to a dash (-). This document may contain device numbers with an underscore (\_). Please check the ON Semiconductor website to verify the updated device numbers. The most current and up-to-date ordering information can be found at [www.onsemi.com](http://www.onsemi.com). Please email any questions regarding the system integration to [Fairchild\\_questions@onsemi.com](mailto:Fairchild_questions@onsemi.com).

ON Semiconductor and the ON Semiconductor logo are trademarks of Semiconductor Components Industries, LLC dba ON Semiconductor or its subsidiaries in the United States and/or other countries. ON Semiconductor owns the rights to a number of patents, trademarks, copyrights, trade secrets, and other intellectual property. A listing of ON Semiconductor's product/patent coverage may be accessed at [www.onsemi.com/site/pdf/Patent-Marking.pdf](http://www.onsemi.com/site/pdf/Patent-Marking.pdf). ON Semiconductor reserves the right to make changes without further notice to any products herein. ON Semiconductor makes no warranty, representation or guarantee regarding the suitability of its products for any particular purpose, nor does ON Semiconductor assume any liability arising out of the application or use of any product or circuit, and specifically disclaims any and all liability, including without limitation special, consequential or incidental damages. Buyer is responsible for its products and applications using ON Semiconductor products, including compliance with all laws, regulations and safety requirements or standards, regardless of any support or applications information provided by ON Semiconductor. "Typical" parameters which may be provided in ON Semiconductor data sheets and/or specifications can and do vary in different applications and actual performance may vary over time. All operating parameters, including "Typicals" must be validated for each customer application by customer's technical experts. ON Semiconductor does not convey any license under its patent rights nor the rights of others. ON Semiconductor products are not designed, intended, or authorized for use as a critical component in life support systems or any FDA Class 3 medical devices or medical devices with a same or similar classification in a foreign jurisdiction or any devices intended for implantation in the human body. Should Buyer purchase or use ON Semiconductor products for any such unintended or unauthorized application, Buyer shall indemnify and hold ON Semiconductor and its officers, employees, subsidiaries, affiliates, and distributors harmless against all claims, costs, damages, and expenses, and reasonable attorney fees arising out of, directly or indirectly, any claim of personal injury or death associated with such unintended or unauthorized use, even if such claim alleges that ON Semiconductor was negligent regarding the design or manufacture of the part. ON Semiconductor is an Equal Opportunity/Affirmative Action Employer. This literature is subject to all applicable copyright laws and is not for resale in any manner.

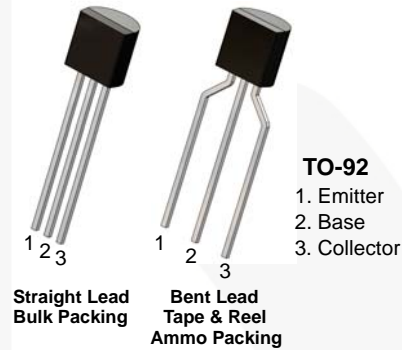


September 2015

# KSP42 / KSP43 NPN Epitaxial Silicon Transistor

## Features

- Collector-Emitter Voltage:  $V_{CEO}$  = KSP42: 300 V  
KSP43: 200 V
- Collector Dissipation:  $P_C$  (max.) = 625 mW



## Ordering Information

Part Number	Top Mark	Package	Packing Method
KSP42BU	KSP42	TO-92 3L	Bulk
KSP42TA	KSP42	TO-92 3L	Ammo
KSP43BU	KSP43	TO-92 3L	Bulk
KSP43TA	KSP43	TO-92 3L	Ammo

## Absolute Maximum Ratings

Stresses exceeding the absolute maximum ratings may damage the device. The device may not function or be operable above the recommended operating conditions and stressing the parts to these levels is not recommended. In addition, extended exposure to stresses above the recommended operating conditions may affect device reliability. The absolute maximum ratings are stress ratings only. Values are at  $T_A = 25^\circ\text{C}$  unless otherwise noted.

Symbol	Parameter	Value	Unit
$V_{CBO}$	Collector-Base Voltage	KSP42	300
		KSP43	200
$V_{CEO}$	Collector-Emitter Voltage	KSP42	300
		KSP43	200
$V_{EBO}$	Emitter-Base Voltage	6	V
$I_C$	Collector Current	500	mA
$P_C$	Collector Power Dissipation	625	mW
$T_J$	Junction Temperature	150	$^\circ\text{C}$
$T_{STG}$	Storage Temperature	-55 to 150	$^\circ\text{C}$

KSP42 / KSP43 — NPN Epitaxial Silicon Transistor

## Electrical Characteristics

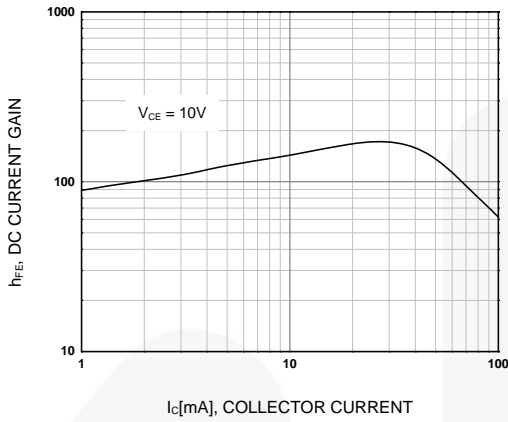
Values are at  $T_A = 25^\circ\text{C}$  unless otherwise noted.

Symbol	Parameter	Conditions	Min.	Max.	Unit	
$BV_{CBO}$	Collector-Base Breakdown Voltage	KSP42	$I_C = 100\ \mu\text{A}, I_E = 0$	300		V
		KSP43		200		
$BV_{CEO}$	Collector-Emitter Breakdown Voltage <sup>(1)</sup>	KSP42	$I_C = 1\ \text{mA}, I_B = 0$	300		V
		KSP43		200		
$BV_{EBO}$	Emitter-Base Breakdown Voltage	$I_E = 100\ \mu\text{A}, I_C = 0$	6		V	
$I_{CBO}$	Collector Cut-Off Current	KSP42	$V_{CB} = 200\ \text{V}, I_E = 0$		100	nA
		KSP43	$V_{CB} = 160\ \text{V}, I_E = 0$		100	
$I_{EBO}$	Emitter Cut-Off Current	KSP42	$V_{EB} = 6\ \text{V}, I_C = 0$		100	nA
		KSP43	$V_{EB} = 4\ \text{V}, I_C = 0$		100	
$h_{FE}$	DC Current Gain <sup>(1)</sup>		$V_{CE} = 10\ \text{V}, I_C = 1\ \text{mA}$	25		
			$V_{CE} = 10\ \text{V}, I_C = 10\ \text{mA}$	40		
			$V_{CE} = 10\ \text{V}, I_C = 30\ \text{mA}$	40		
$V_{CE(sat)}$	Collector-Emitter Saturation Voltage <sup>(1)</sup>	$I_C = 20\ \text{mA}, I_B = 2\ \text{mA}$		0.5	V	
$V_{BE(sat)}$	Base-Emitter Saturation Voltage <sup>(1)</sup>	$I_C = 20\ \text{mA}, I_B = 2\ \text{mA}$		0.9	V	
$C_{ob}$	Output Capacitance	KSP42	$V_{CB} = 20\ \text{V}, I_E = 0,$ $f = 1\ \text{MHz}$		3	pF
		KSP43			4	
$f_T$	Current Gain Bandwidth Product	$V_{CE} = 20\ \text{V}, I_C = 10\ \text{mA},$ $f = 100\ \text{MHz}$	50		MHz	

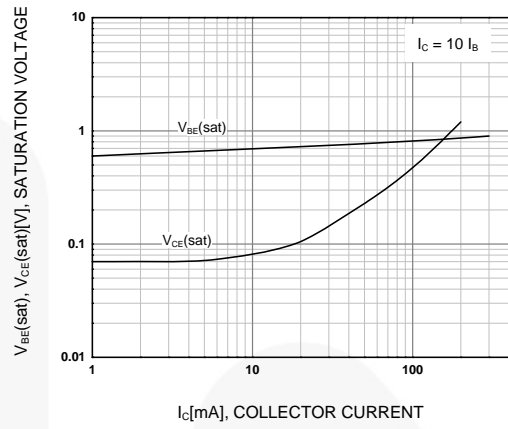
### Note:

1. Pulse test: pulse width  $\leq 300\ \mu\text{s}$ , duty cycle  $\leq 2\%$ .

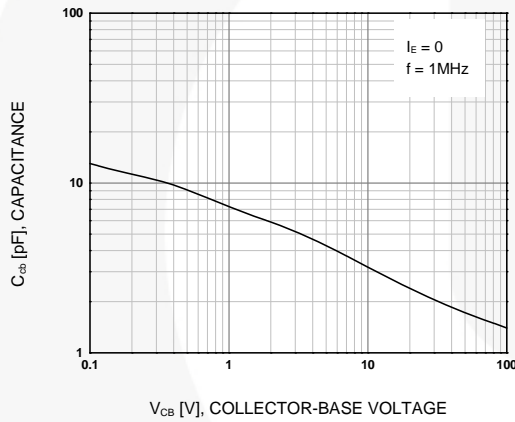
## Typical Performance Characteristics



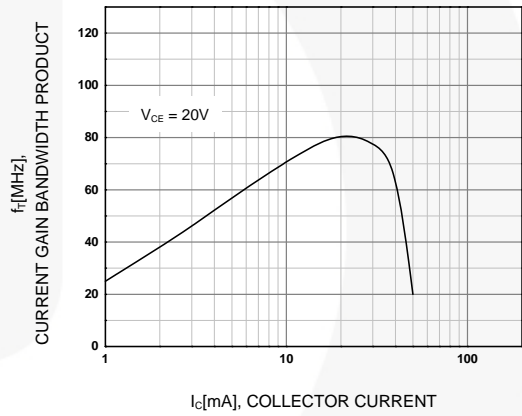
**Figure 1. DC Current Gain**



**Figure 2. Collector-Emitter Saturation Voltage and Base-Emitter Saturation Voltage**

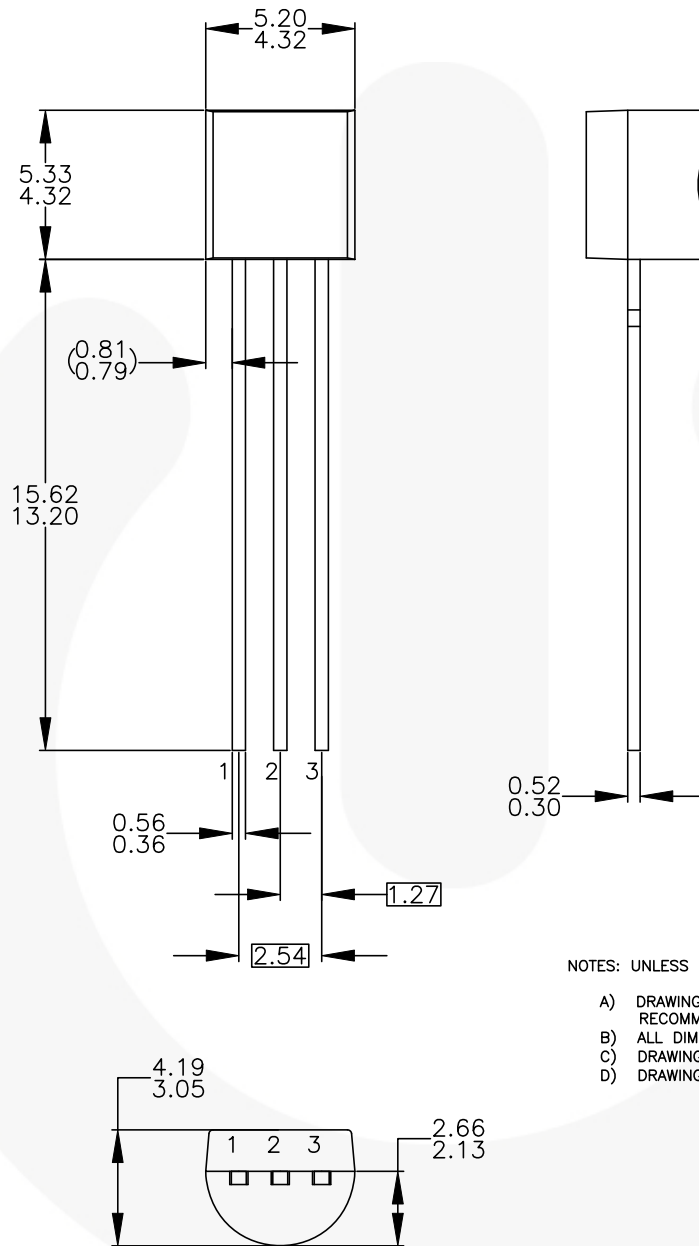


**Figure 3. Collector-Base Capacitance**



**Figure 4. Current Gain Bandwidth Product**

Physical Dimensions



NOTES: UNLESS OTHERWISE SPECIFIED

- A) DRAWING WITH REFERENCE TO JEDEC TO-92 RECOMMENDATIONS.
- B) ALL DIMENSIONS ARE IN MILLIMETERS.
- C) DRAWING CONFORMS TO ASME Y14.5M-2009.
- D) DRAWING FILENAME: MKT-ZA03DREV4.



Figure 5. 3-Lead, TO-92, JEDEC TO-92 Compliant Straight Lead Configuration, Bulk Type

Physical Dimensions (Continued)

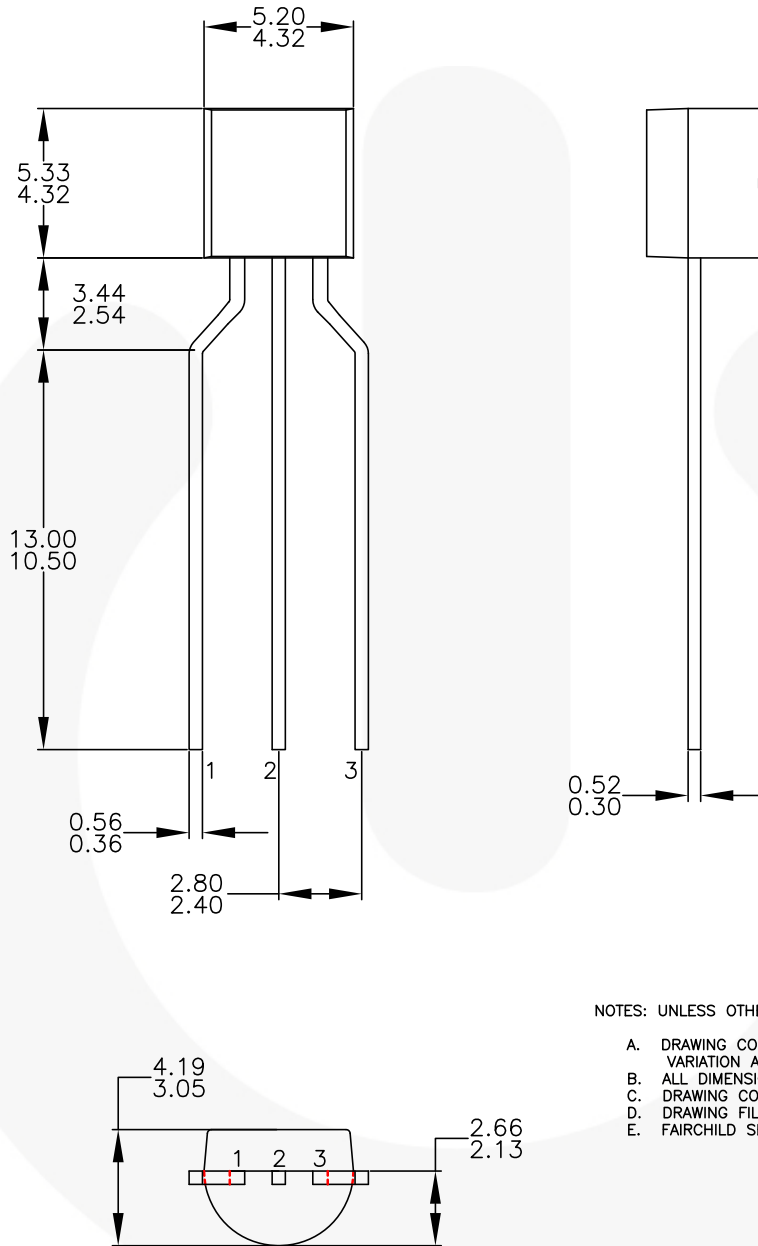







Figure 6. 3-Lead, TO-92, Molded, 0.2 In Line Spacing Lead Form, Ammo, Tape and Reel Type



**TRADEMARKS**

The following includes registered and unregistered trademarks and service marks, owned by Fairchild Semiconductor and/or its global subsidiaries, and is not intended to be an exhaustive list of all such trademarks.

- |                                                                                              |                                                |                                                                                     |                                                                                                     |
|----------------------------------------------------------------------------------------------|------------------------------------------------|-------------------------------------------------------------------------------------|-----------------------------------------------------------------------------------------------------|
| AccuPower™                                                                                   | F-PFS™                                         | OPTOPLANAR®                                                                         |  SYSTEM GENERAL® |
| AttitudeEngine™                                                                              | FRFET®                                         |  ® | TinyBoost®                                                                                          |
| Awinda®                                                                                      | Global Power Resource™                         | Power Supply WebDesigner™                                                           | TinyBuck®                                                                                           |
| AX-CAP®*                                                                                     | GreenBridge™                                   | PowerTrench®                                                                        | TinyCalc™                                                                                           |
| BitSiC™                                                                                      | Green FPS™                                     | PowerXS™                                                                            | TinyLogic®                                                                                          |
| Build it Now™                                                                                | Green FPS™ e-Series™                           | Programmable Active Droop™                                                          | TINYOPTO™                                                                                           |
| CorePLUS™                                                                                    | Gmax™                                          | QFET®                                                                               | TinyPower™                                                                                          |
| CorePOWER™                                                                                   | GTO™                                           | QS™                                                                                 | TinyPWM™                                                                                            |
| CROSSVOLT™                                                                                   | IntelliMAX™                                    | Quiet Series™                                                                       | TinyWire™                                                                                           |
| CTL™                                                                                         | ISOPLANAR™                                     | RapidConfigure™                                                                     | TranSiC™                                                                                            |
| Current Transfer Logic™                                                                      | Making Small Speakers Sound Louder and Better™ |  ™ | TriFault Detect™                                                                                    |
| DEUXPEED®                                                                                    | MegaBuck™                                      | Saving our world, 1mW/W/kW at a time™                                               | TRUECURRENT®*                                                                                       |
| Dual Cool™                                                                                   | MICROCOUPLER™                                  | SignalWise™                                                                         | μSerDes™                                                                                            |
| EcoSPARK®                                                                                    | MicroFET™                                      | SmartMax™                                                                           |  SerDes™         |
| EfficientMax™                                                                                | MicroPak™                                      | SMART START™                                                                        | UHC®                                                                                                |
| ESBC™                                                                                        | MicroPak2™                                     | Solutions for Your Success™                                                         | Ultra FRFET™                                                                                        |
|  Fairchild® | MillerDrive™                                   | SPM®                                                                                | UniFET™                                                                                             |
| Fairchild Semiconductor®                                                                     | MotionMax™                                     | STEALTH™                                                                            | VCX™                                                                                                |
| FACT Quiet Series™                                                                           | MotionGrid®                                    | SuperFET®                                                                           | VisualMax™                                                                                          |
| FACT®                                                                                        | MTi®                                           | SuperSOT™-3                                                                         | VoltagePlus™                                                                                        |
| FastvCore™                                                                                   | MTx®                                           | SuperSOT™-6                                                                         | XS™                                                                                                 |
| FastBench™                                                                                   | MVN®                                           | SuperSOT™-8                                                                         | Xsens™                                                                                              |
| FPS™                                                                                         | mWSaver®                                       | SupreMOS®                                                                           | 仙童™                                                                                                 |
|                                                                                              | OptoHiT™                                       | SyncFET™                                                                            |                                                                                                     |
|                                                                                              | OPTOLOGIC®                                     | Sync-Lock™                                                                          |                                                                                                     |

\* Trademarks of System General Corporation, used under license by Fairchild Semiconductor.

**DISCLAIMER**

FAIRCHILD SEMICONDUCTOR RESERVES THE RIGHT TO MAKE CHANGES WITHOUT FURTHER NOTICE TO ANY PRODUCTS HEREIN TO IMPROVE RELIABILITY, FUNCTION, OR DESIGN. TO OBTAIN THE LATEST, MOST UP-TO-DATE DATASHEET AND PRODUCT INFORMATION, VISIT OUR WEBSITE AT [HTTP://WWW.FAIRCHILDSEMI.COM](http://www.fairchildsemi.com). FAIRCHILD DOES NOT ASSUME ANY LIABILITY ARISING OUT OF THE APPLICATION OR USE OF ANY PRODUCT OR CIRCUIT DESCRIBED HEREIN; NEITHER DOES IT CONVEY ANY LICENSE UNDER ITS PATENT RIGHTS, NOR THE RIGHTS OF OTHERS. THESE SPECIFICATIONS DO NOT EXPAND THE TERMS OF FAIRCHILD'S WORLDWIDE TERMS AND CONDITIONS, SPECIFICALLY THE WARRANTY THEREIN, WHICH COVERS THESE PRODUCTS.

**AUTHORIZED USE**

Unless otherwise specified in this data sheet, this product is a standard commercial product and is not intended for use in applications that require extraordinary levels of quality and reliability. This product may not be used in the following applications, unless specifically approved in writing by a Fairchild officer: (1) automotive or other transportation, (2) military/aerospace, (3) any safety critical application – including life critical medical equipment – where the failure of the Fairchild product reasonably would be expected to result in personal injury, death or property damage. Customer's use of this product is subject to agreement of this Authorized Use policy. In the event of an unauthorized use of Fairchild's product, Fairchild accepts no liability in the event of product failure. In other respects, this product shall be subject to Fairchild's Worldwide Terms and Conditions of Sale, unless a separate agreement has been signed by both Parties.

**ANTI-COUNTERFEITING POLICY**

Fairchild Semiconductor Corporation's Anti-Counterfeiting Policy. Fairchild's Anti-Counterfeiting Policy is also stated on our external website, [www.fairchildsemi.com](http://www.fairchildsemi.com), under Terms of Use

Counterfeiting of semiconductor parts is a growing problem in the industry. All manufacturers of semiconductor products are experiencing counterfeiting of their parts. Customers who inadvertently purchase counterfeit parts experience many problems such as loss of brand reputation, substandard performance, failed applications, and increased cost of production and manufacturing delays. Fairchild is taking strong measures to protect ourselves and our customers from the proliferation of counterfeit parts. Fairchild strongly encourages customers to purchase Fairchild parts either directly from Fairchild or from Authorized Fairchild Distributors who are listed by country on our web page cited above. Products customers buy either from Fairchild directly or from Authorized Fairchild Distributors are genuine parts, have full traceability, meet Fairchild's quality standards for handling and storage and provide access to Fairchild's full range of up-to-date technical and product information. Fairchild and our Authorized Distributors will stand behind all warranties and will appropriately address any warranty issues that may arise. Fairchild will not provide any warranty coverage or other assistance for parts bought from Unauthorized Sources. Fairchild is committed to combat this global problem and encourage our customers to do their part in stopping this practice by buying direct or from authorized distributors.

**PRODUCT STATUS DEFINITIONS**

**Definition of Terms**

Datasheet Identification	Product Status	Definition
Advance Information	Formative / In Design	Datasheet contains the design specifications for product development. Specifications may change in any manner without notice.
Preliminary	First Production	Datasheet contains preliminary data; supplementary data will be published at a later date. Fairchild Semiconductor reserves the right to make changes at any time without notice to improve design.
No Identification Needed	Full Production	Datasheet contains final specifications. Fairchild Semiconductor reserves the right to make changes at any time without notice to improve the design.
Obsolete	Not In Production	Datasheet contains specifications on a product that is discontinued by Fairchild Semiconductor. The datasheet is for reference information only.

Rev. 176

ON Semiconductor and  are trademarks of Semiconductor Components Industries, LLC dba ON Semiconductor or its subsidiaries in the United States and/or other countries. ON Semiconductor owns the rights to a number of patents, trademarks, copyrights, trade secrets, and other intellectual property. A listing of ON Semiconductor's product/patent coverage may be accessed at [www.onsemi.com/site/pdf/Patent-Marking.pdf](http://www.onsemi.com/site/pdf/Patent-Marking.pdf). ON Semiconductor reserves the right to make changes without further notice to any products herein. ON Semiconductor makes no warranty, representation or guarantee regarding the suitability of its products for any particular purpose, nor does ON Semiconductor assume any liability arising out of the application or use of any product or circuit, and specifically disclaims any and all liability, including without limitation special, consequential or incidental damages. Buyer is responsible for its products and applications using ON Semiconductor products, including compliance with all laws, regulations and safety requirements or standards, regardless of any support or applications information provided by ON Semiconductor. "Typical" parameters which may be provided in ON Semiconductor data sheets and/or specifications can and do vary in different applications and actual performance may vary over time. All operating parameters, including "Typicals" must be validated for each customer application by customer's technical experts. ON Semiconductor does not convey any license under its patent rights nor the rights of others. ON Semiconductor products are not designed, intended, or authorized for use as a critical component in life support systems or any FDA Class 3 medical devices or medical devices with a same or similar classification in a foreign jurisdiction or any devices intended for implantation in the human body. Should Buyer purchase or use ON Semiconductor products for any such unintended or unauthorized application, Buyer shall indemnify and hold ON Semiconductor and its officers, employees, subsidiaries, affiliates, and distributors harmless against all claims, costs, damages, and expenses, and reasonable attorney fees arising out of, directly or indirectly, any claim of personal injury or death associated with such unintended or unauthorized use, even if such claim alleges that ON Semiconductor was negligent regarding the design or manufacture of the part. ON Semiconductor is an Equal Opportunity/Affirmative Action Employer. This literature is subject to all applicable copyright laws and is not for resale in any manner.

## PUBLICATION ORDERING INFORMATION

### LITERATURE FULFILLMENT:



Literature Distribution Center for ON Semiconductor  
19521 E. 32nd Pkwy, Aurora, Colorado 80011 USA  
**Phone:** 303-675-2175 or 800-344-3860 Toll Free USA/Canada  
**Fax:** 303-675-2176 or 800-344-3867 Toll Free USA/Canada  
**Email:** [orderlit@onsemi.com](mailto:orderlit@onsemi.com)

**N. American Technical Support:** 800-282-9855 Toll Free  
USA/Canada  
**Europe, Middle East and Africa Technical Support:**  
Phone: 421 33 790 2910  
**Japan Customer Focus Center**  
Phone: 81-3-5817-1050

**ON Semiconductor Website:** [www.onsemi.com](http://www.onsemi.com)  
**Order Literature:** <http://www.onsemi.com/orderlit>  
For additional information, please contact your local  
Sales Representative

## Looking for pricing, stock, or lifecycle information?

Click below to explore more details on WIN SOURCE:

-  [View KSP43TA on WIN SOURCE](#)
-  [Fairchild/ON Semiconductor Information](#)

## Optimize Your Supply Chain with WIN SOURCE Solutions

-  Global Sourcing Solution
-  Obsolete Management
-  Cost Control Management
-  Shortage Management
-  Alternative Solution
-  Excess Inventory Management