



ON Semiconductor®

<http://onsemi.com>

# L88M05T

Monolithic Linear IC

## 17V, 5V / 0.5A Low Dropout Voltage Regulator

### Overview

The L88M05T is low dropout voltage regulator IC with output current of 0.5 A. Because they can operate with a low input-output voltage difference, they contribute to smaller and more efficient set power supplies, and are optimum for audio-visual and office automation equipment.

### Functions

- Output voltage : 5V
- 500 mA output current
- Low minimum input-output voltage differential (0.4V typ) enables to save energy and miniaturize transformer size.
- Set size can be miniaturized with compact TP-3H power package.
- Surface mounting on board permits allowable power dissipation to be raised.
- Enhanced mount flexibility with range of formed products.

### Specifications

**Maximum Ratings** at  $T_a = 25^\circ\text{C}$

Parameter	Symbol	Conditions	Ratings	Unit
Input voltage	$V_{IN \text{ max}}$		18	V
Allowable power dissipation	$P_d \text{ max}$	$T_a \leq 25^\circ\text{C}$ , no heat sink	1	W
		$T_c = 25^\circ\text{C}$ , with infinite heat sink	6.25	W
Thermal resistance (junction-atmosphere)	$\theta_{j-a}$		125	$^\circ\text{C}/\text{W}$
Thermal resistance (junction-to-case)	$\theta_{j-c}$		20	$^\circ\text{C}/\text{W}$
Operating temperature	$T_{opr}$		-20 to +85	$^\circ\text{C}$
Storage temperature	$T_{stg}$		-55 to +150	$^\circ\text{C}$

Stresses exceeding Maximum Ratings may damage the device. Maximum Ratings are stress ratings only. Functional operation above the Recommended Operating Conditions is not implied. Extended exposure to stresses above the Recommended Operating Conditions may affect device reliability.

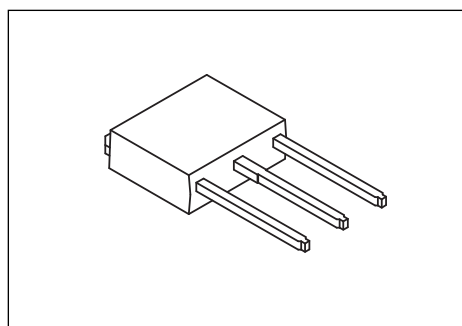

TP3H

### ORDERING INFORMATION

See detailed ordering and shipping information on page 8 of this data sheet.

## L88M00T Series

### Pin Assignment

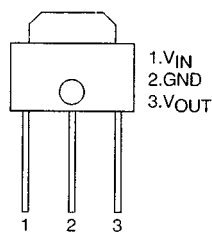

A10242

Top view

### Operating Conditions at $T_a = 25\text{ }^\circ\text{C}$

Parameter	Symbol	Conditions	Ratings	Unit
Input voltage	$V_{IN}$		5.8 to 17	V
Output current	$I_{OUT}$		0 to 500	mA

### Operating Characteristics at $T_j = 25\text{ }^\circ\text{C}$ , $V_{IN} = 8\text{ V}$ , $I_O = 500\text{ mA}$ , $C_{OUT} = 100\text{ }\mu\text{F}$ , $C_{IN} = 1\text{ }\mu\text{F}$ , see specified Test Circuit.

Parameter	Symbol	Conditions	min	typ	max	Unit
Output voltage	$V_{OUT}$		4.85	5.0	5.15	V
Dropout voltage	$V_{DROP1}$			0.4	0.6	V
	$V_{DROP2}$	$I_O = 150\text{ mA}$		0.2	0.3	V
Line regulation	$\Delta V_{OLN}$	5.8 V % $V_{IN}$ % 17 V		10	50	mV
Load regulation	$\Delta V_{OLD}$	5 mA % $I_{OUT}$ % 500 mA		30	100	mV
Peak output current	$I_{OP}$		600	900		mA
Output short-circuit current	$I_{OSC}$			100	300	mA
Quiescent current	$I_{Q1}$	$I_{OUT} = 0$		2.0	5.0	mA
	$I_{Q2}$			24	50	mA
Output noise voltage	$V_{NO}$	10 Hz % f % 100 kHz		40		$\mu\text{V}_{rms}$
Temperature coefficient of output voltage	$\Delta V_{OUT}/\Delta T_j$	$T_j = 25\text{ to }125\text{ }^\circ\text{C}$		$\pm 0.5$		mV/ $^\circ\text{C}$
Ripple rejection	Rrej	f = 120 Hz, 6 V % $V_{IN}$ % 17 V		65		dB

# L88M05T

## Package Dimensions

unit : mm

**IPAK / TP3H**  
**CASE 369AF**  
**ISSUE A**

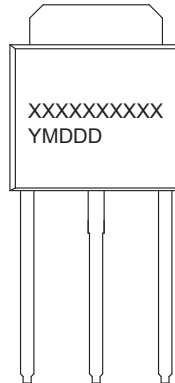
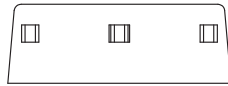
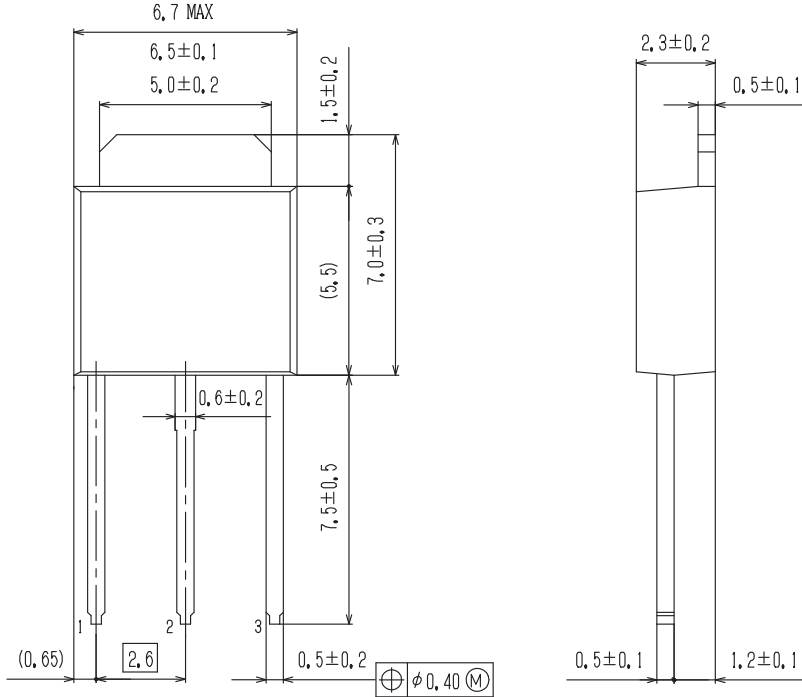

### GENERIC MARKING DIAGRAM\*

XXXXXX = Specific Device Code  
 Y = Year  
 M = Month  
 DDD = Additional Traceability Data

\*This information is generic. Please refer to device data sheet for actual part marking. Pb-Free indicator, "G" or microdot "▪", may or may not be present.

### SOLDERING FOOTPRINT\*

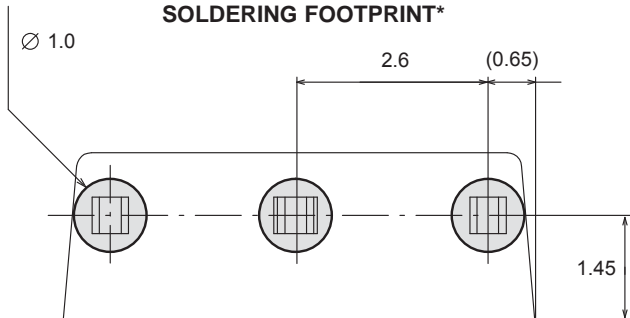

NOTE: The measurements are not to guarantee but for reference only.

(Unit: mm)

Package name
TP3H

○ Through Hole Area

\*For additional information on our Pb-Free strategy and soldering details, please download the ON Semiconductor Soldering and Mounting Techniques Reference Manual, SOLDERRM/D.

## L88M00T Series

### Equivalent Circuit Block Diagram (Common to L88M00T Series)

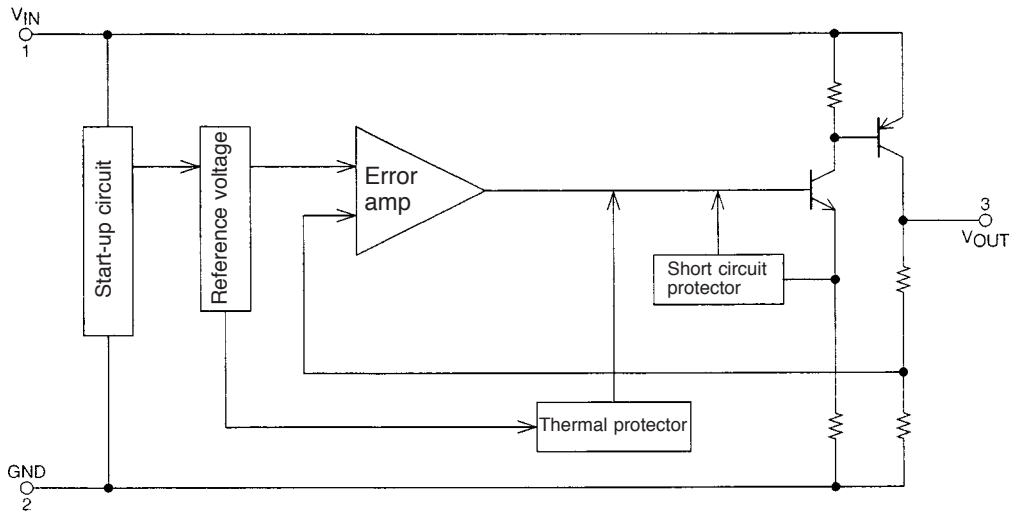

A10243

### Test Circuit (Common to L88M00T Series)

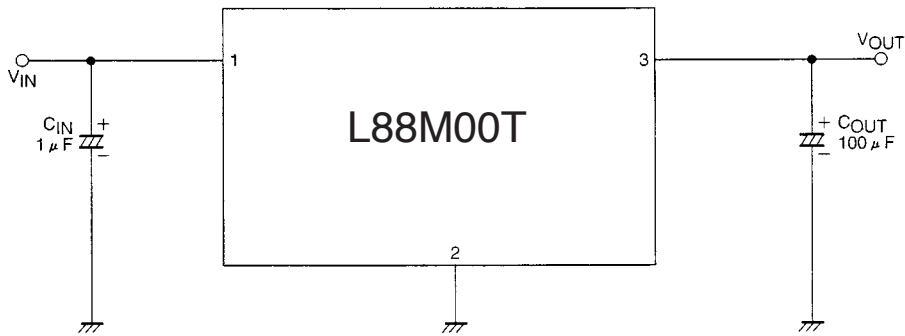

A10244

- Notes:
1. To ensure operational stability,  $C_{IN}$  and  $C_{OUT}$  should be placed as close to the IC as possible.
  2. Because the output capacitor  $C_{OUT}$  is set at over  $100 \mu\text{F}$  to prevent oscillation at low temperatures, a capacitor that exhibits little change in capacity with temperature variations should be used (such as a tantalum capacitor).
  3. When  $V_{IN}$  is minus (-) and GND is plus (+) (reversed connection), excessive current flow will occur.

## L88M00T Series

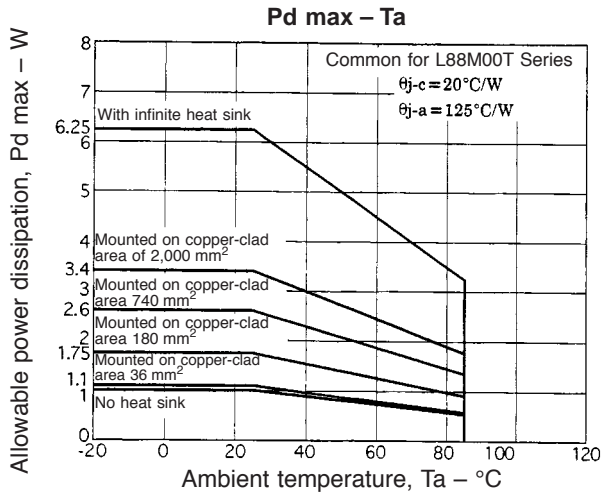

- 1) The allowable power dissipation is 1.0 W ( $T_a = 25^\circ\text{C}$ ) with no fin attached, but when mounted on a hybrid IC board or printed circuit board, high allowable power dissipation is achieved, despite the compact package. The graph below depicts the relationship between the copper-clad area and allowable power dissipation when mounted on a glass epoxy board ( $50 \times 50 \times 0.8 \text{ mm}^3$ ) with a copper thickness of  $18 \mu\text{m}$ .

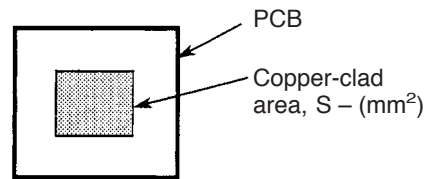
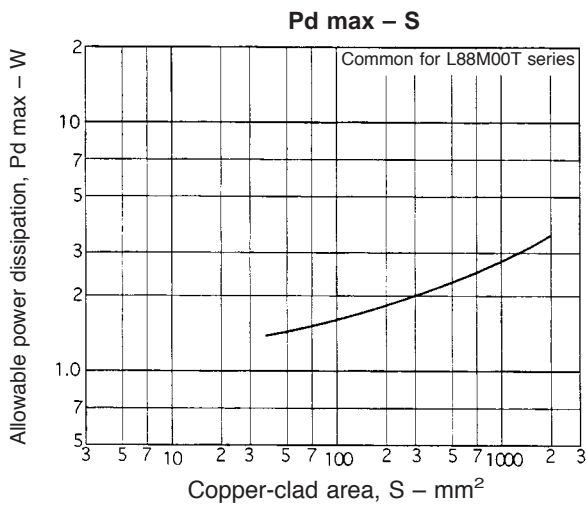

- 2) Pd is the value for when the solder on the surface of the IC heat sink has melted completely and the surface mount is horizontal.
- 3) Please be advised that the flow solder application system (full-heat method) cannot be recommended.

### Lead Formings

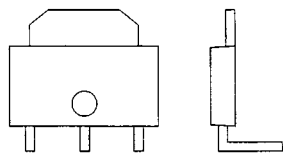

LR forming

A10245

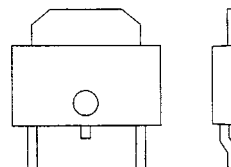

FA forming

A10246

# L88M00T Series

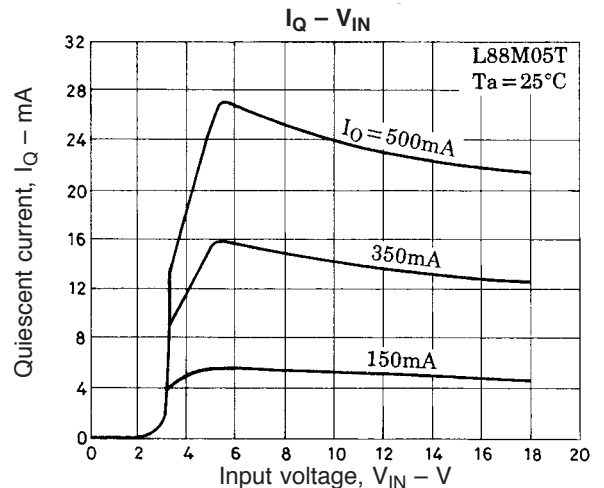
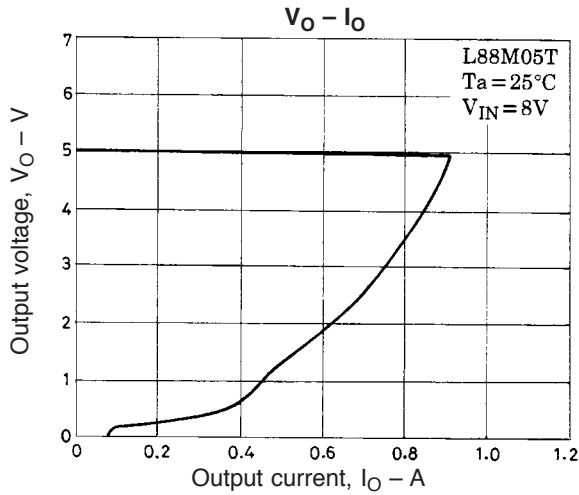
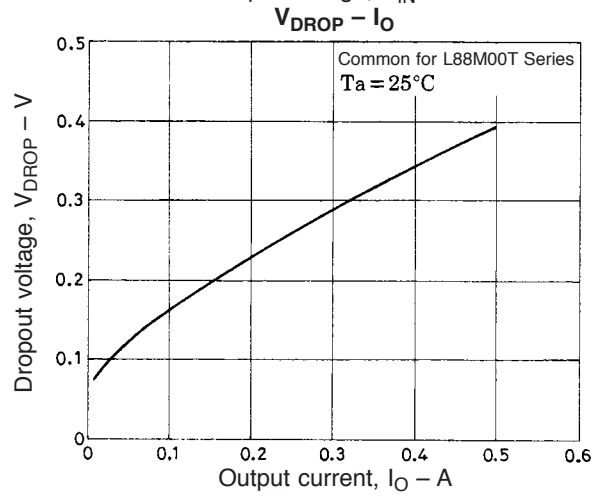
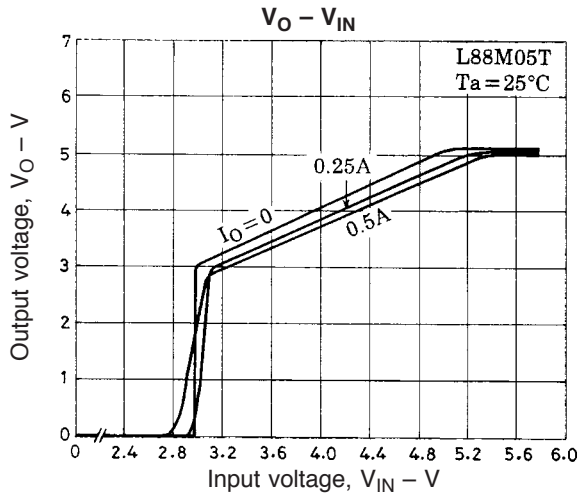
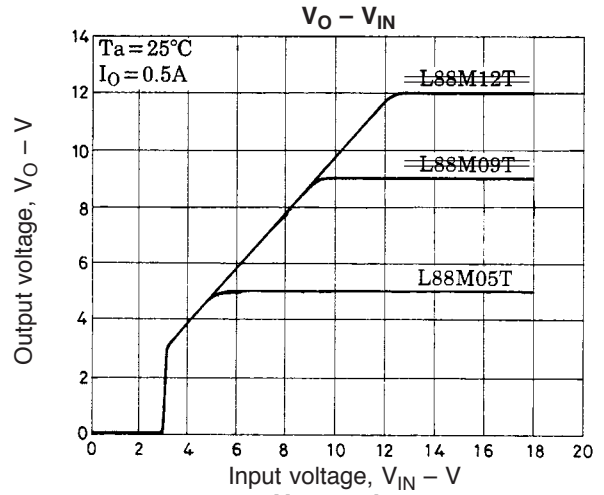

# L88M00T Series

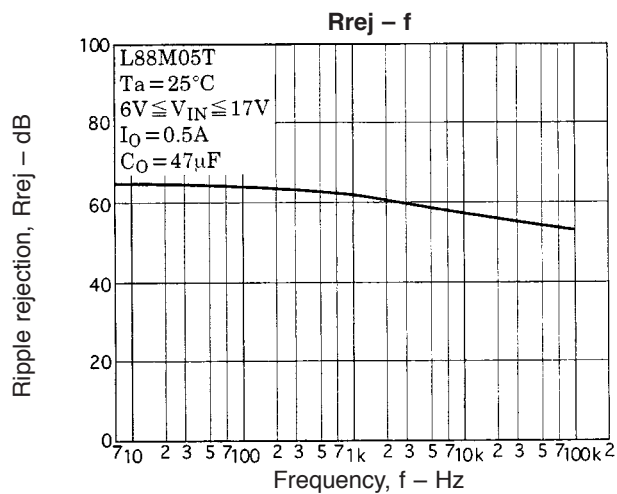
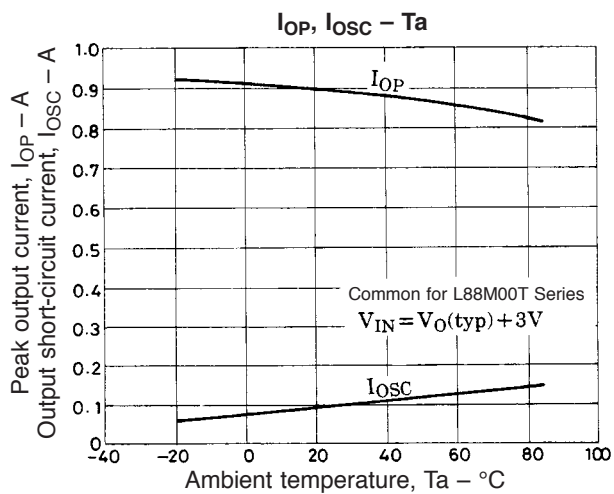
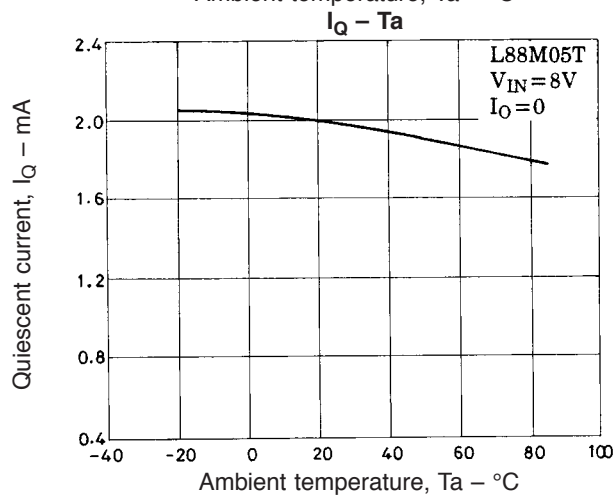
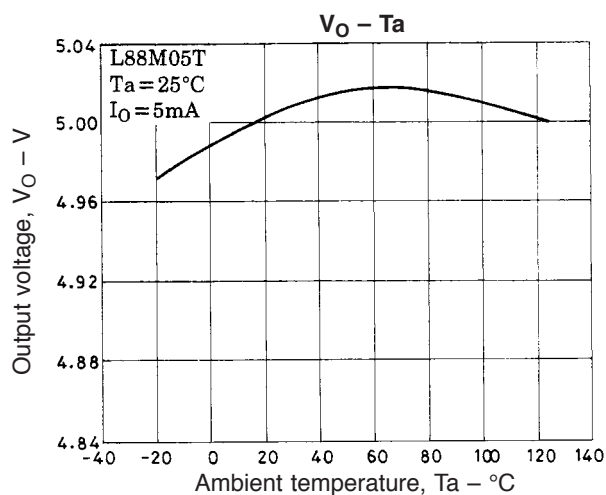
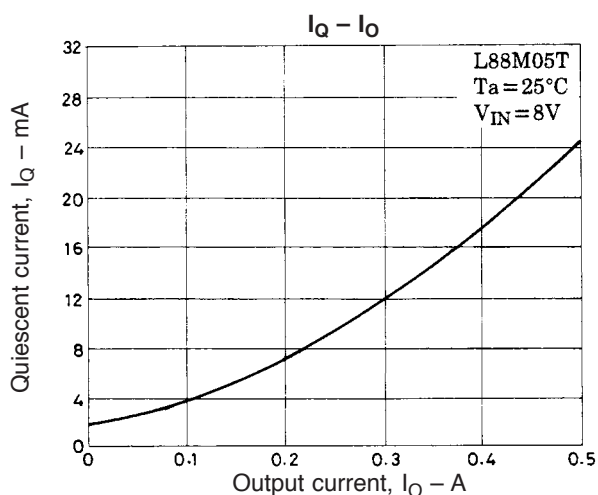

# L88M05T



## ORDERING INFORMATION

Device	Package	Shipping (Qty / Packing)
L88M05T-E	TP3H (Pb-Free)	500 / Bulk Bag
L88M05TL-FA-E	TP3H (Pb-Free)	500 / Bulk Bag
L88M05TLL-E	TP3H (Pb-Free)	500 / Bulk Bag
L88M05TL-LR-E	TP3H (Pb-Free)	500 / Bulk Bag
L88M05TL-TL-E	TP3H (Pb-Free)	700 / Tape & Reel
L88M05T-TL-E	TP3H (Pb-Free)	700 / Tape & Reel

ON Semiconductor and the ON logo are registered trademarks of Semiconductor Components Industries, LLC (SCILLC). SCILLC owns the rights to a number of patents, trademarks, copyrights, trade secrets, and other intellectual property. A listing of SCILLC's product/patent coverage may be accessed at [www.onsemi.com/site/pdf/Patent-Marking.pdf](http://www.onsemi.com/site/pdf/Patent-Marking.pdf). SCILLC reserves the right to make changes without further notice to any products herein. SCILLC makes no warranty, representation or guarantee regarding the suitability of its products for any particular purpose, nor does SCILLC assume any liability arising out of the application or use of any product or circuit, and specifically disclaims any and all liability, including without limitation special, consequential or incidental damages. "Typical" parameters which may be provided in SCILLC data sheets and/or specifications can and do vary in different applications and actual performance may vary over time. All operating parameters, including "Typicals" must be validated for each customer application by customer's technical experts. SCILLC does not convey any license under its patent rights nor the rights of others. SCILLC products are not designed, intended, or authorized for use as components in systems intended for surgical implant into the body, or other applications intended to support or sustain life, or for any other application in which the failure of the SCILLC product could create a situation where personal injury or death may occur. Should Buyer purchase or use SCILLC products for any such unintended or unauthorized application, Buyer shall indemnify and hold SCILLC and its officers, employees, subsidiaries, affiliates, and distributors harmless against all claims, costs, damages, and expenses, and reasonable attorney fees arising out of, directly or indirectly, any claim of personal injury or death associated with such unintended or unauthorized use, even if such claim alleges that SCILLC was negligent regarding the design or manufacture of the part. SCILLC is an Equal Opportunity/Affirmative Action Employer. This literature is subject to all applicable copyright laws and is not for resale in any manner.

## Looking for pricing, stock, or lifecycle information?

Click below to explore more details on WIN SOURCE:

-  [View L88M05](#) on WIN SOURCE
-  [ON Semiconductor](#) Information

## Optimize Your Supply Chain with WIN SOURCE Solutions

-  Global Sourcing Solution
-  Obsolete Management
-  Cost Control Management
-  Shortage Management
-  Alternative Solution
-  Excess Inventory Management