



THE DATASHEET OF LD1084V



5 A low-drop positive voltage regulator adjustable

Datasheet - production data

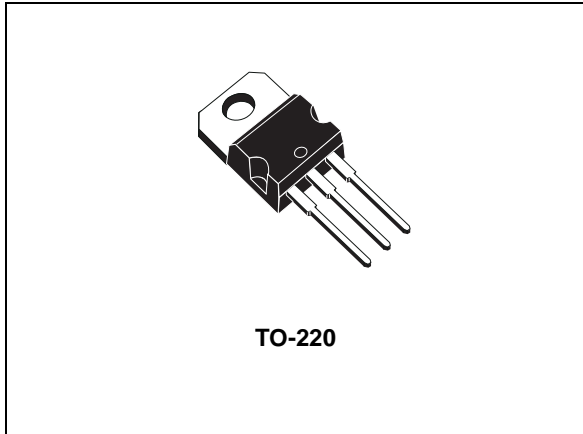

LD1084 quiescent current flows into the load, so to increase the efficiency. A minimum capacitor of 10 μ F is needed for stability.

The device is supplied in TO-220. The on-chip trimming allows the regulator to reach a very tight output voltage tolerance, within $\pm 1\%$ at 25 °C.

Table 1. Device summary

Order code	Output voltage
LD1084V	adjustable

Features

- Typical dropout 1.3 V (at 5 A)
- Three-terminal adjustable output voltage
- Guaranteed output current up to 5 A
- Output tolerance $\pm 1\%$ at 25 °C and $\pm 2\%$ in full temperature range
- Internal power and thermal limit
- Wide operating temperature range -40 °C to 125 °C
- Package available: TO-220
- Pinout compatibility with standard adjustable VREG

Description

The LD1084 is a low-drop voltage regulator providing up to 5 A of output current. Dropout is guaranteed at a maximum of 1.5 V at the maximum output current, decreasing at lower loads. The LD1084 is pin-to-pin compatible with the older 3-terminal adjustable regulators, but it has better performances in terms of drop and output tolerance.

Unlike PNP regulators, where a part of the output current is wasted as quiescent current, the

Contents

1	Diagram	3
2	Pin configuration	4
3	Maximum ratings	5
4	Schematic application	6
5	Electrical characteristics	7
6	Typical performance characteristics	8
7	Package mechanical data	13
8	Revision history	15

1 Diagram

Figure 1. Schematic diagram

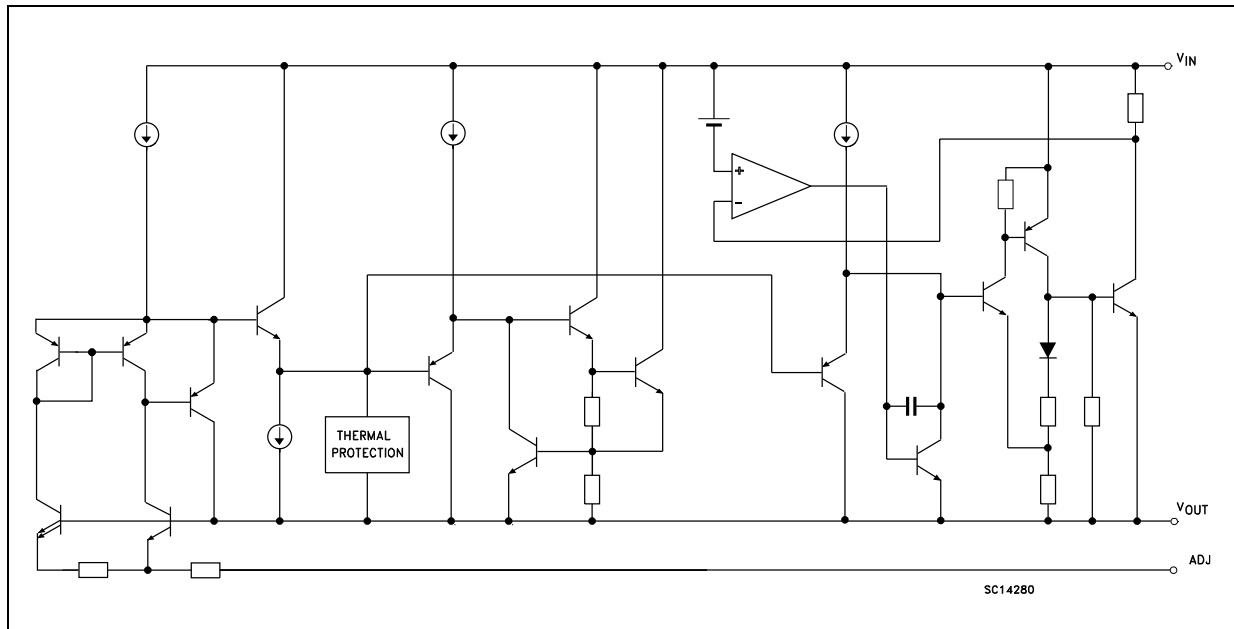

2 Pin configuration

Figure 2. Pin connections (top view)

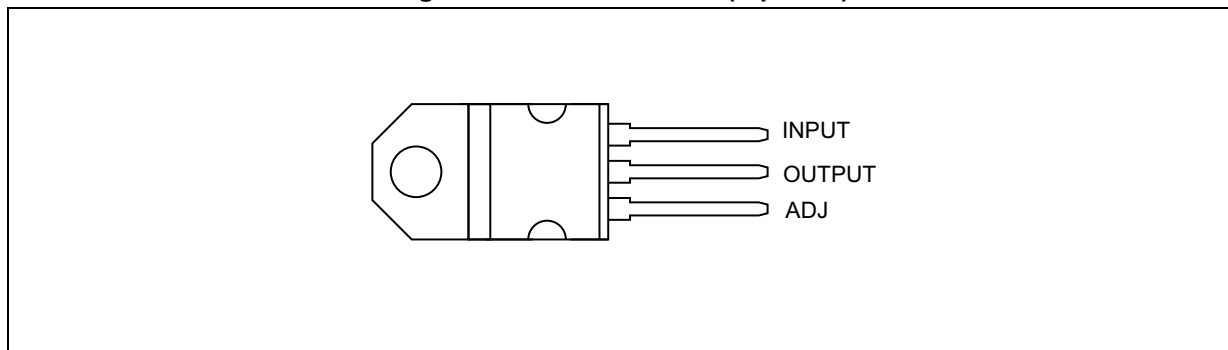

3 Maximum ratings

Table 2. Absolute maximum ratings

Symbol	Parameter	Value	Unit
V_I	DC input voltage	30	V
I_O	Output current	Internally limited	mA
P_D	Power dissipation	Internally limited	mW
T_{STG}	Storage temperature range	-55 to +150	°C
T_{OP}	Operating junction temperature range	-40 to +125	°C

Note: Absolute maximum ratings are those values beyond which damage to the device may occur. Functional operation under these conditions is not implied.

Table 3. Thermal data

Symbol	Parameter	TO-220	Unit
R_{thJC}	Thermal resistance junction-case	3	°C/W
R_{thJA}	Thermal resistance junction-ambient	50	°C/W

4 Schematic application

Figure 3. Application circuit

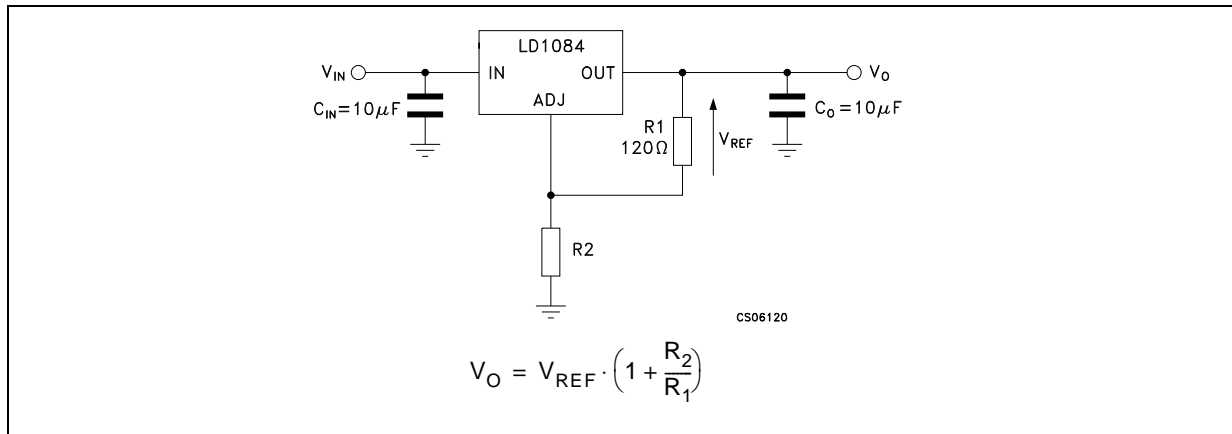

5 Electrical characteristics

$V_I = 4.25\text{ V}$, $C_I = C_O = 10\ \mu\text{F}$, $T_A = -40\text{ to }125\text{ }^\circ\text{C}$, unless otherwise specified.

Table 4. LD1084 electrical characteristics

Symbol	Parameter	Test conditions	Min.	Typ.	Max.	Unit
V_{ref}	Reference voltage ⁽¹⁾	$I_O = 10\text{ mA}$, $T_J = 25\text{ }^\circ\text{C}$	1.237	1.25	1.263	V
		$I_O = 10\text{ mA to }3\text{ A}$, $V_I = 2.85\text{ to }30\text{ V}$	1.225	1.25	1.275	V
ΔV_O	Line regulation	$I_O = 10\text{ mA}$, $V_I = 2.85\text{ to }16.5\text{ V}$, $T_J = 25\text{ }^\circ\text{C}$		0.015	0.2	%
		$I_O = 10\text{ mA}$, $V_I = 2.85\text{ to }16.5\text{ V}$		0.035	0.2	%
ΔV_O	Load regulation	$I_O = 10\text{ mA to }5\text{ A}$, $T_J = 25\text{ }^\circ\text{C}$		0.1	0.3	%
		$I_O = 0\text{ to }5\text{ A}$		0.2	0.4	%
V_d	Dropout voltage	$I_O = 5\text{ A}$		1.3	1.5	V
$I_{O(\text{min})}$	Minimum load current	$V_I = 30\text{ V}$		3	10	mA
I_{sc}	Short-circuit current	$V_I - V_O = 5\text{ V}$	5.5	6.5		A
		$V_I - V_O = 25\text{ V}$	0.5	0.7		A
	Thermal regulation	$T_A = 25\text{ }^\circ\text{C}$, 30 ms pulse		0.003	0.015	%/W
SVR	Supply voltage rejection	$f = 120\text{ Hz}$, $C_O = 25\ \mu\text{F}$, $C_{\text{ADJ}} = 25\ \mu\text{F}$, $I_O = 5\text{ A}$, $V_I = 6.25 \pm 3\text{ V}$	60	72		dB
I_{ADJ}	Adjust pin current	$V_I = 4.25\text{ V}$, $I_O = 10\text{ mA}$		55	120	μA
ΔI_{ADJ}	Adjust pin current change ⁽¹⁾	$I_O = 10\text{ mA to }5\text{ A}$, $V_I = 2.85\text{ to }16.5\text{ V}$		0.2	5	μA
eN	RMS output noise voltage (% of V_O)	$T_A = 25\text{ }^\circ\text{C}$, $f = 10\text{ Hz to }10\text{ kHz}$		0.003		%
S	Temperature stability			0.5		%
S	Long term stability	$T_A = 125\text{ }^\circ\text{C}$, 1000 hrs		0.5		%

1. See short-circuit current curve for available output current at fixed dropout.

6 Typical performance characteristics

Unless otherwise specified $T_J = 25\text{ }^\circ\text{C}$, $C_I = 10\text{ }\mu\text{F}$ (tant.), $C_O = 22\text{ }\mu\text{F}$ (tant.)

Figure 4. Short-circuit current vs. dropout voltage

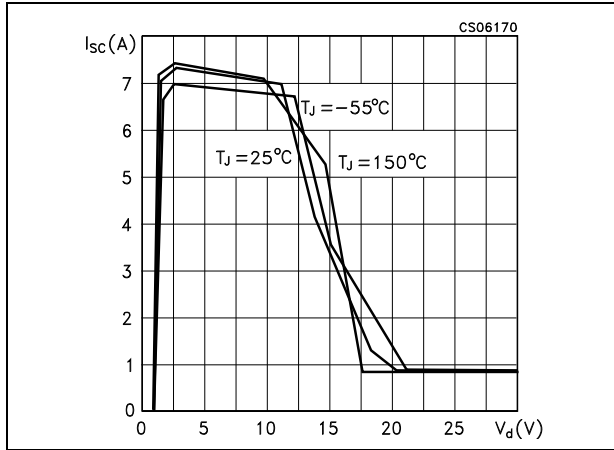

Figure 5. Line regulation vs. temperature

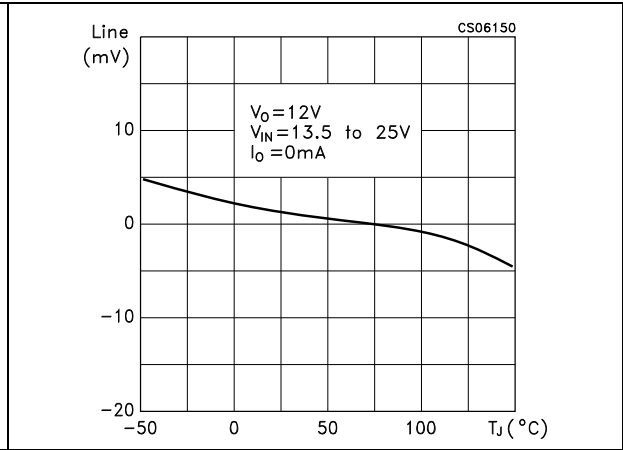

Figure 6. Quiescent current vs. temperature

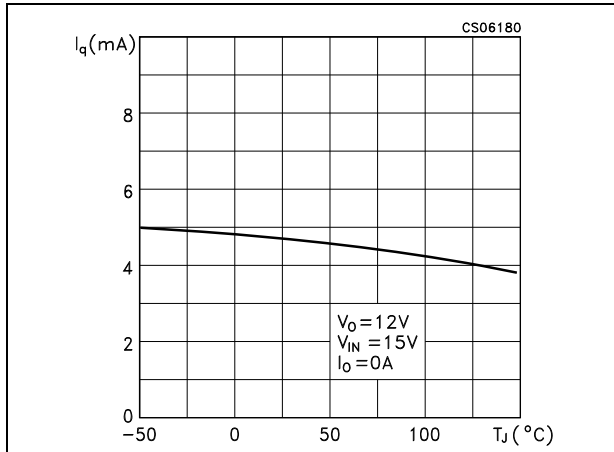

Figure 7. Output voltage vs. temperature

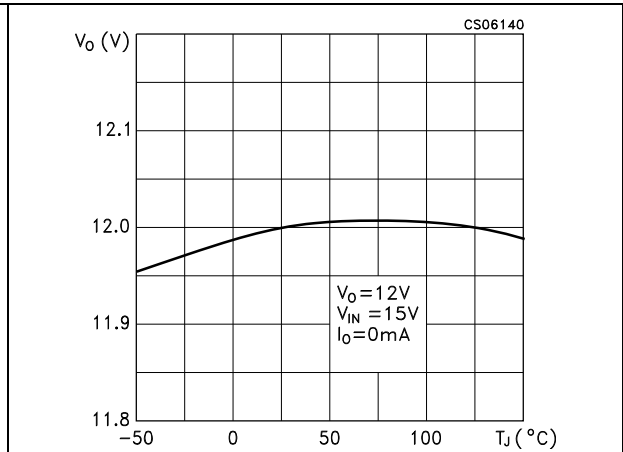

Figure 8. Load regulation vs. temperature

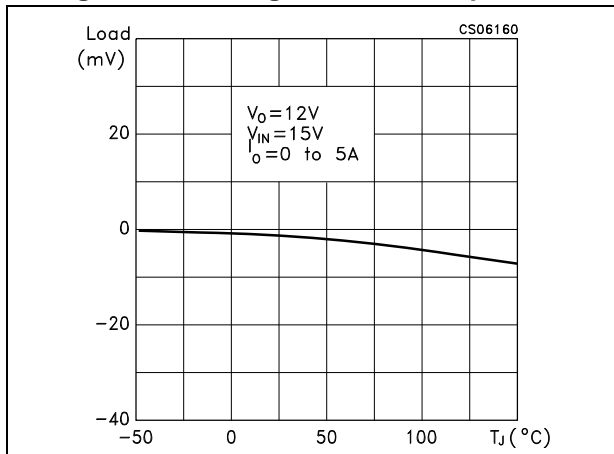

Figure 9. Quiescent current vs. output voltage

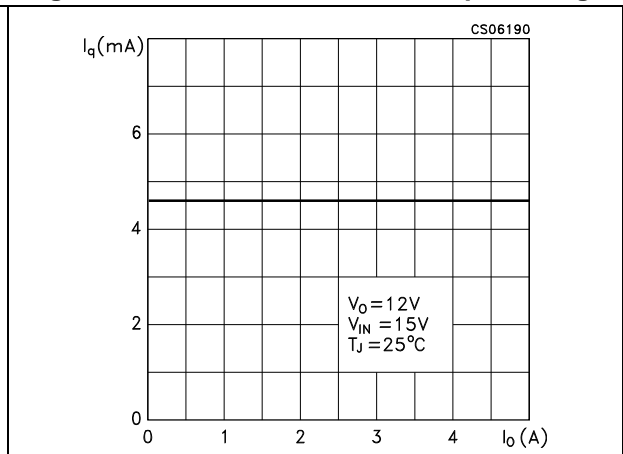

Figure 10. Quiescent current vs. input voltage

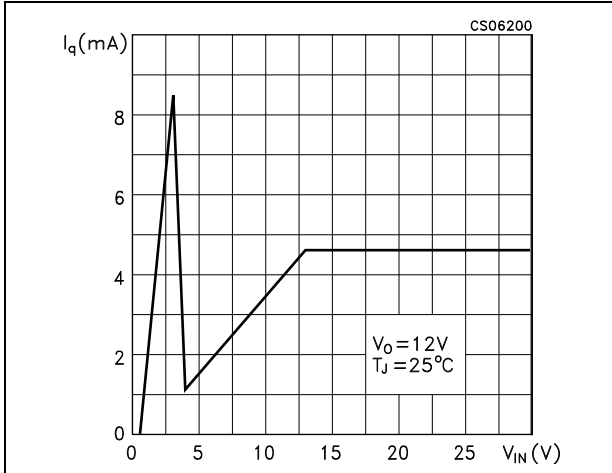

Figure 11. Dropout voltage vs. output current

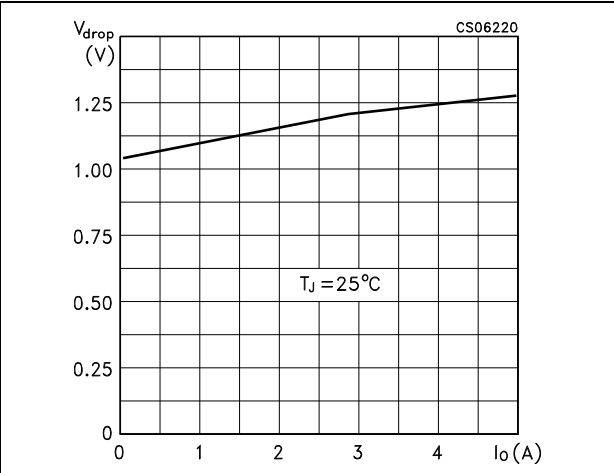

Figure 12. Supply voltage rejection vs. output current

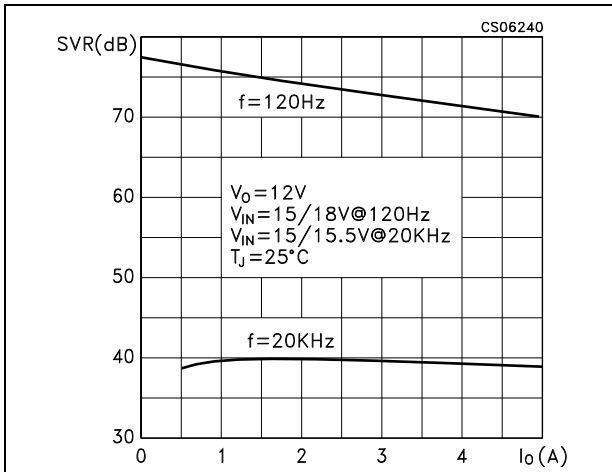

Figure 13. Dropout voltage vs. temperature

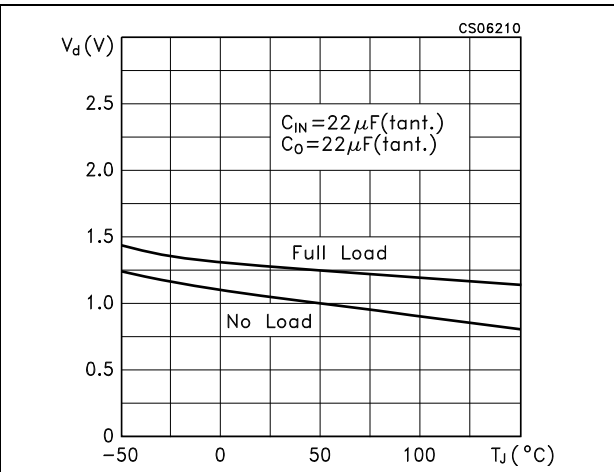

Figure 14. Supply voltage rejection vs. temperature

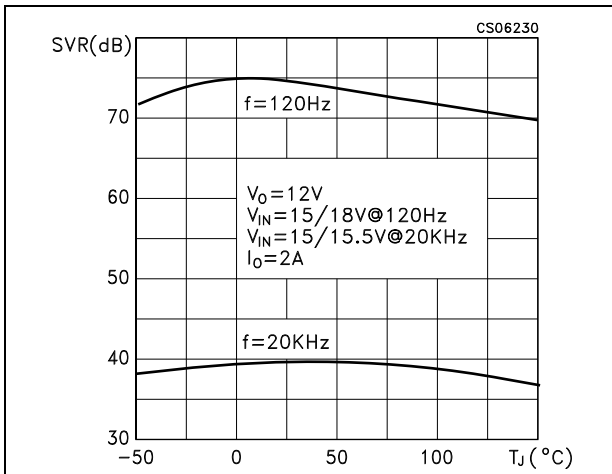

Figure 15. Supply voltage rejection vs. frequency

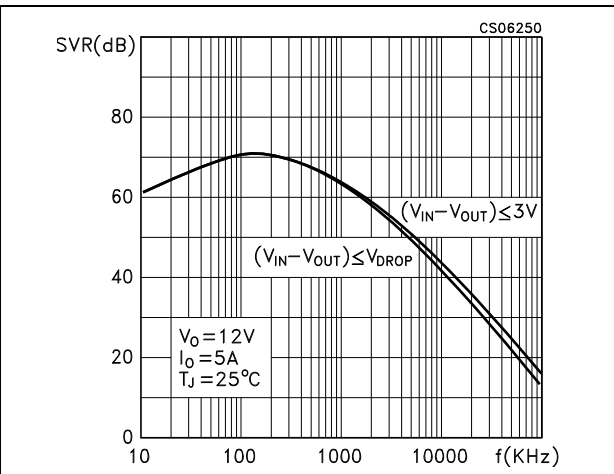

Figure 16. Adjust pin current vs. output current

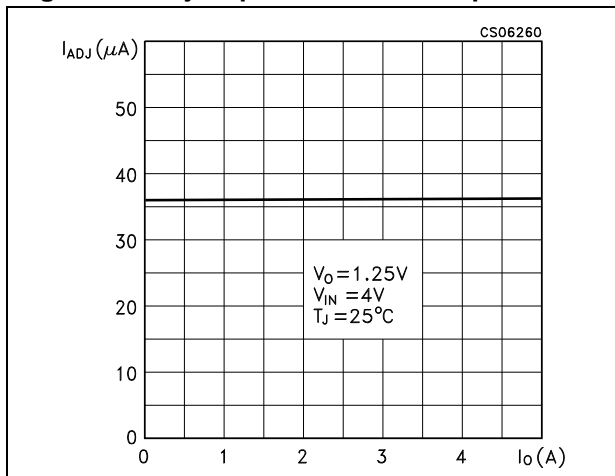

Figure 17. Reference voltage vs. temperature

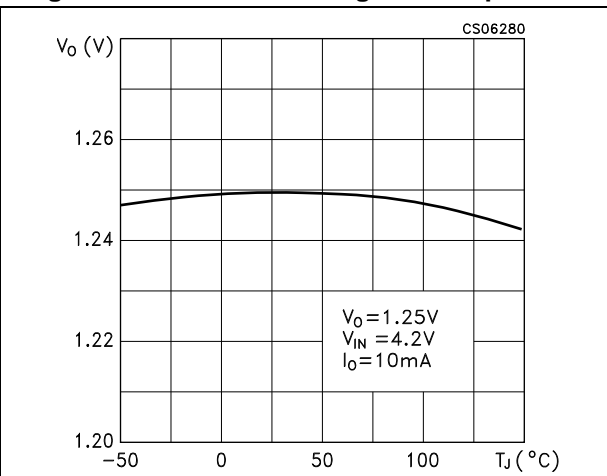

Figure 18. Load regulation vs. temperature

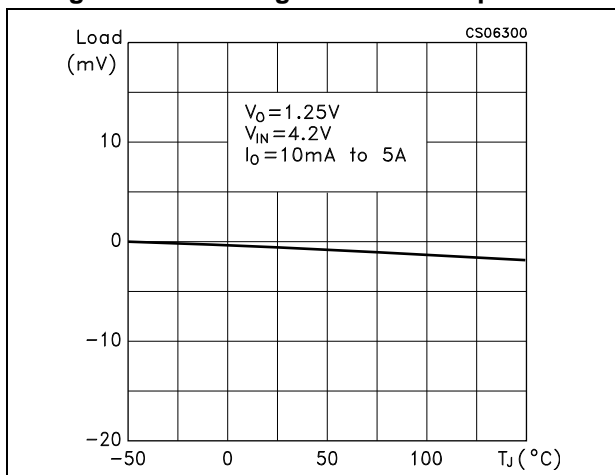

Figure 19. Adjust pin current vs. temperature

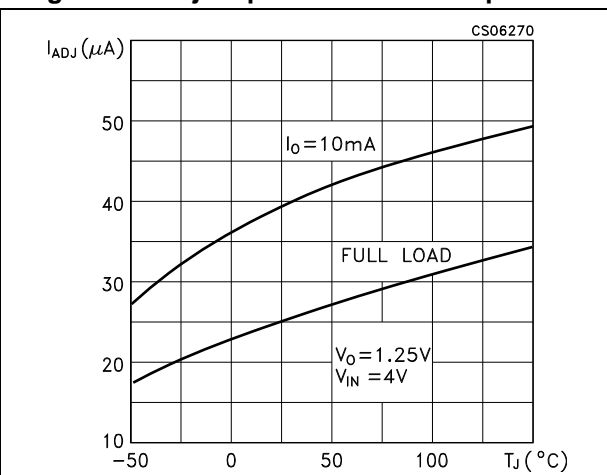

Figure 20. Line regulation vs. temperature

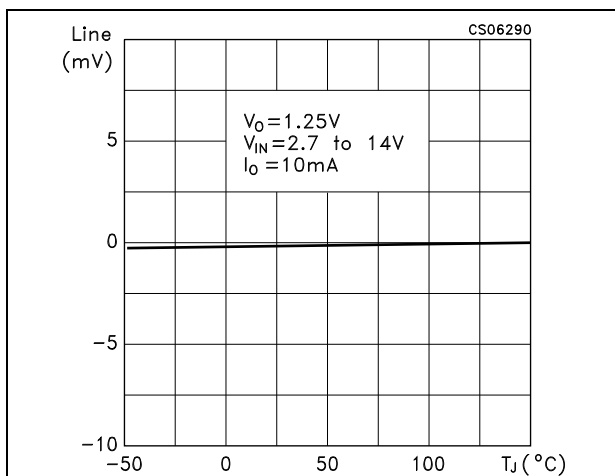

Figure 21. Minimum load current vs. temperature

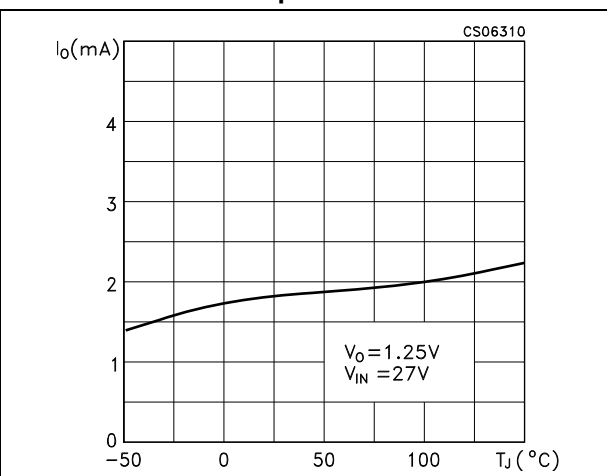

Figure 22. Supply voltage rejection vs. temperature

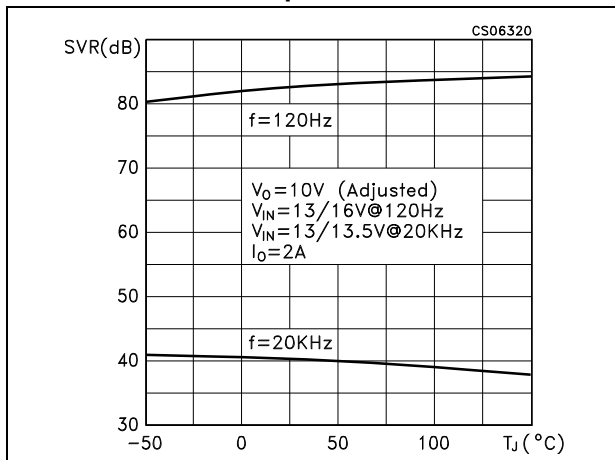

Figure 24. Stability

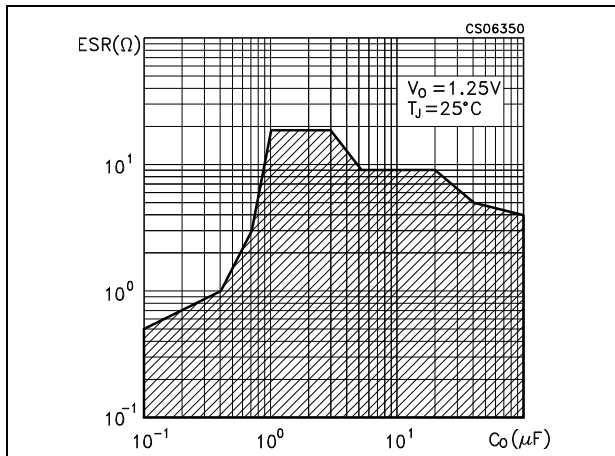

Figure 26. Stability

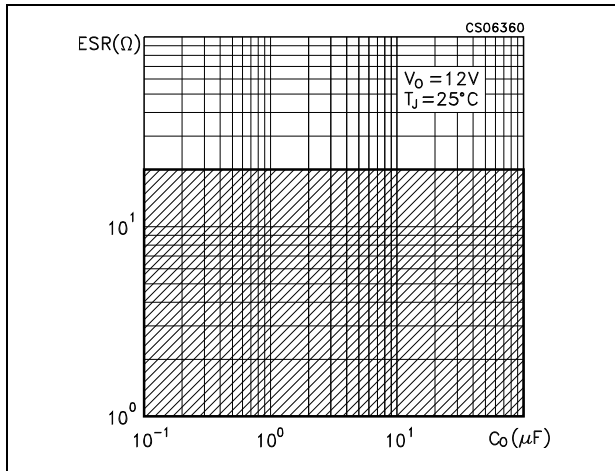

Figure 23. Supply voltage rejection vs. frequency

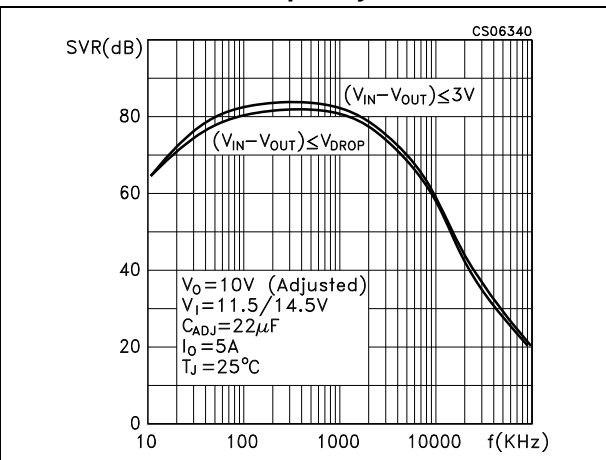

Figure 25. Supply voltage rejection vs. output current

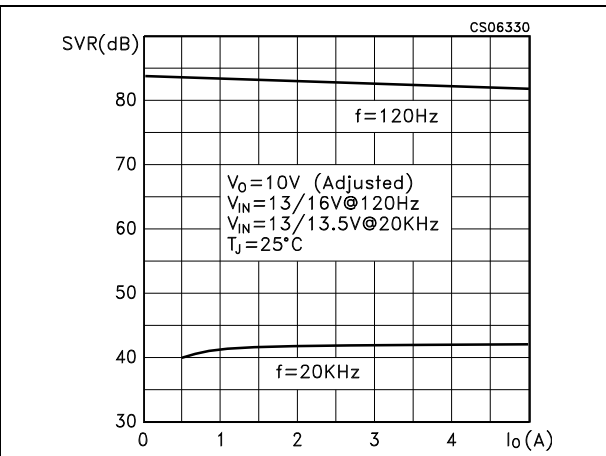

Figure 27. Line transient

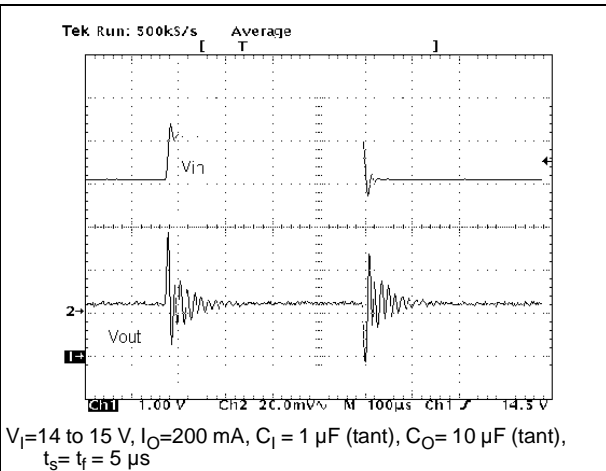

Figure 28. Line transient

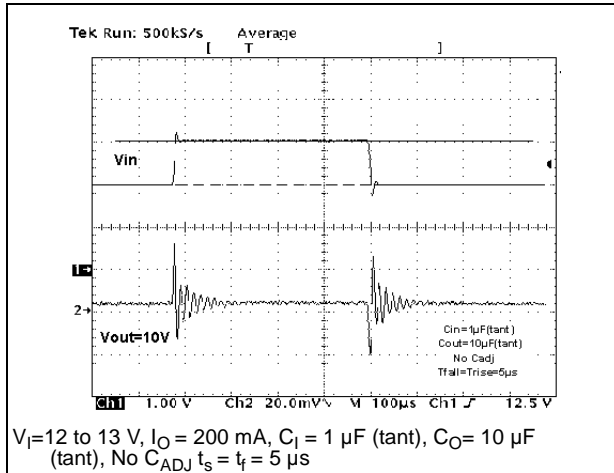

Figure 29. Load transient

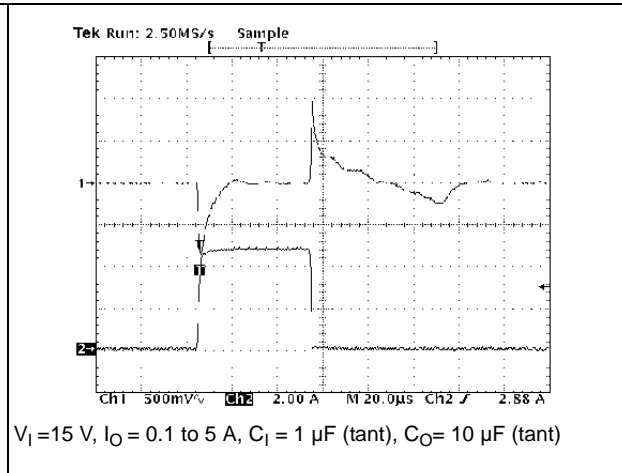

Figure 30. Load transient

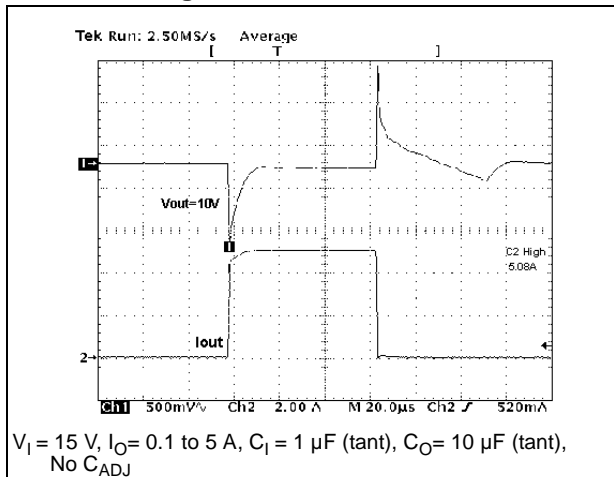

Figure 31. Line transient

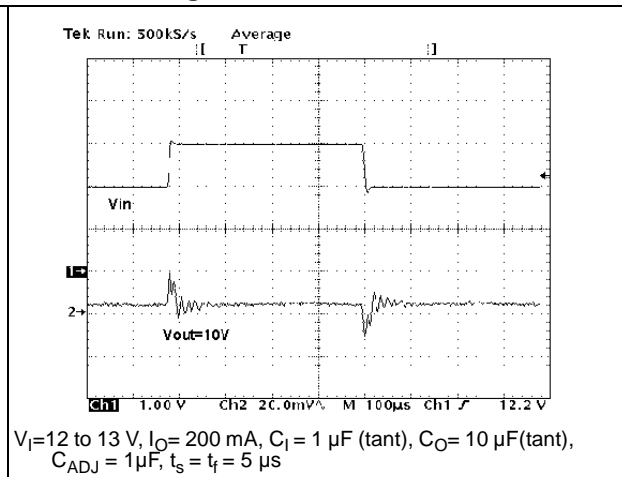
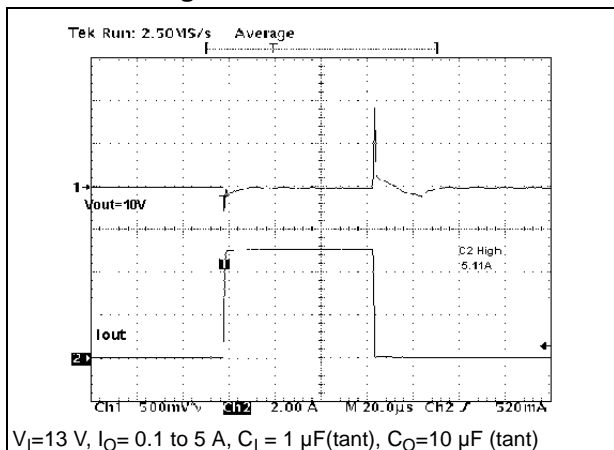

Figure 32. Load transient



7 Package mechanical data

In order to meet environmental requirements, ST offers these devices in different grades of ECOPACK® packages, depending on their level of environmental compliance. ECOPACK® specifications, grade definitions and product status are available at: www.st.com. ECOPACK® is an ST trademark.

Table 5. TO-220 mechanical data

Dim.	mm		
	Min.	Typ.	Max.
A	4.40		4.60
b	0.61		0.88
b1	1.14		1.70
c	0.48		0.70
D	15.25		15.75
E	10		10.40
e	2.40		2.70
e1	4.95		5.15
F	0.51		0.60
H1	6.20		6.60
J1	2.40		2.72
L	13		14
L1	3.50		3.93
L20		16.40	
L30		28.90	
ØP	3.75		3.85
Q	2.65		2.95

8 Revision history

Table 6. Document revision history

Date	Revision	Changes
07-Oct-2004	3	Mistake order codes - Table 1.
08-Feb-2005	4	Mistake U.M. Load Regulation - V ==> mV.
16-Jun-2005	5	Order codes updated.
04-Apr-2007	6	Order code updated.
07-Jun-2007	7	Order codes updated.
08-Apr-2008	8	Modified: Table 1 on page 1 . Removed: packages D ² PAK, D ² PAK/A and mechanical data.
29-Jul-2009	9	Modified: Table 1 on page 1 .
04-Sep-2013	10	RPN LD1084XX changed to LD1084. Updated the Description in cover page, Section 7: Package mechanical data , Figure 2: Pin connections (top view) and Figure 3: Application circuit . Minor text changes.

Please Read Carefully:

Information in this document is provided solely in connection with ST products. STMicroelectronics NV and its subsidiaries ("ST") reserve the right to make changes, corrections, modifications or improvements, to this document, and the products and services described herein at any time, without notice.

All ST products are sold pursuant to ST's terms and conditions of sale.

Purchasers are solely responsible for the choice, selection and use of the ST products and services described herein, and ST assumes no liability whatsoever relating to the choice, selection or use of the ST products and services described herein.

No license, express or implied, by estoppel or otherwise, to any intellectual property rights is granted under this document. If any part of this document refers to any third party products or services it shall not be deemed a license grant by ST for the use of such third party products or services, or any intellectual property contained therein or considered as a warranty covering the use in any manner whatsoever of such third party products or services or any intellectual property contained therein.

UNLESS OTHERWISE SET FORTH IN ST'S TERMS AND CONDITIONS OF SALE ST DISCLAIMS ANY EXPRESS OR IMPLIED WARRANTY WITH RESPECT TO THE USE AND/OR SALE OF ST PRODUCTS INCLUDING WITHOUT LIMITATION IMPLIED WARRANTIES OF MERCHANTABILITY, FITNESS FOR A PARTICULAR PURPOSE (AND THEIR EQUIVALENTS UNDER THE LAWS OF ANY JURISDICTION), OR INFRINGEMENT OF ANY PATENT, COPYRIGHT OR OTHER INTELLECTUAL PROPERTY RIGHT.

ST PRODUCTS ARE NOT AUTHORIZED FOR USE IN WEAPONS. NOR ARE ST PRODUCTS DESIGNED OR AUTHORIZED FOR USE IN: (A) SAFETY CRITICAL APPLICATIONS SUCH AS LIFE SUPPORTING, ACTIVE IMPLANTED DEVICES OR SYSTEMS WITH PRODUCT FUNCTIONAL SAFETY REQUIREMENTS; (B) AERONAUTIC APPLICATIONS; (C) AUTOMOTIVE APPLICATIONS OR ENVIRONMENTS, AND/OR (D) AEROSPACE APPLICATIONS OR ENVIRONMENTS. WHERE ST PRODUCTS ARE NOT DESIGNED FOR SUCH USE, THE PURCHASER SHALL USE PRODUCTS AT PURCHASER'S SOLE RISK, EVEN IF ST HAS BEEN INFORMED IN WRITING OF SUCH USAGE, UNLESS A PRODUCT IS EXPRESSLY DESIGNATED BY ST AS BEING INTENDED FOR "AUTOMOTIVE, AUTOMOTIVE SAFETY OR MEDICAL" INDUSTRY DOMAINS ACCORDING TO ST PRODUCT DESIGN SPECIFICATIONS. PRODUCTS FORMALLY ESCC, QML OR JAN QUALIFIED ARE DEEMED SUITABLE FOR USE IN AEROSPACE BY THE CORRESPONDING GOVERNMENTAL AGENCY.

Resale of ST products with provisions different from the statements and/or technical features set forth in this document shall immediately void any warranty granted by ST for the ST product or service described herein and shall not create or extend in any manner whatsoever, any liability of ST.

ST and the ST logo are trademarks or registered trademarks of ST in various countries.

Information in this document supersedes and replaces all information previously supplied.

The ST logo is a registered trademark of STMicroelectronics. All other names are the property of their respective owners.

© 2013 STMicroelectronics - All rights reserved



STMicroelectronics group of companies

Australia - Belgium - Brazil - Canada - China - Czech Republic - Finland - France - Germany - Hong Kong - India - Israel - Italy - Japan - Malaysia - Malta - Morocco - Philippines - Singapore - Spain - Sweden - Switzerland - United Kingdom - United States of America

www.st.com

Looking for pricing, stock, or lifecycle information?

Click below to explore more details on WIN SOURCE:

-  [View LD1084V on WIN SOURCE](#)
-  [STMicroelectronics](#) Information

Optimize Your Supply Chain with WIN SOURCE Solutions

-  Global Sourcing Solution
-  Obsolete Management
-  Cost Control Management
-  Shortage Management
-  Alternative Solution
-  Excess Inventory Management