



**THE DATASHEET OF
LD29300D2T33R**



3 A, very low drop voltage regulator

Datasheet - production data

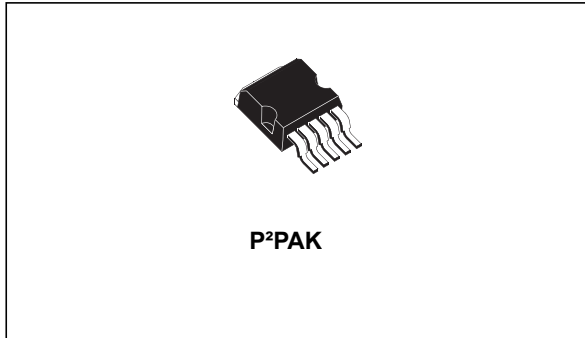
Table 1. Device summary

Order codes	Output voltages
LD29300P2MTR	ADJ

Features

- Very low dropout voltage (typ. 0.4 V at 3 A)
- High accuracy: $\pm 1\%$ @ 25°C
- Guaranteed output current up to 3 A
- Internal current and thermal limit
- Logic controlled electronic shutdown

Description

The LD29300 is a high current, high accuracy, low-dropout voltage regulator. This regulator features 400 mV dropout voltage and very low ground current. Designed for high current loads, this device is also used in lower current, extremely low dropout-critical systems, where its tiny dropout voltage and ground current values are important attributes. Typical applications are in power supply switching post regulation, series power supply for monitors, series power supply for VCRs and TVs, computer systems and battery-powered systems.

Contents

1	Diagram	3
2	Pin configuration	4
3	Typical application	5
4	Maximum ratings	6
5	Electrical characteristics	7
6	Typical characteristics	8
7	Package information	11
	7.1 P ² PAK package information	11
8	Packaging information	14
	8.1 P ² PAK packaging information	14
9	Revision history	16

2 Pin configuration

Figure 2. Pin connections (top view)

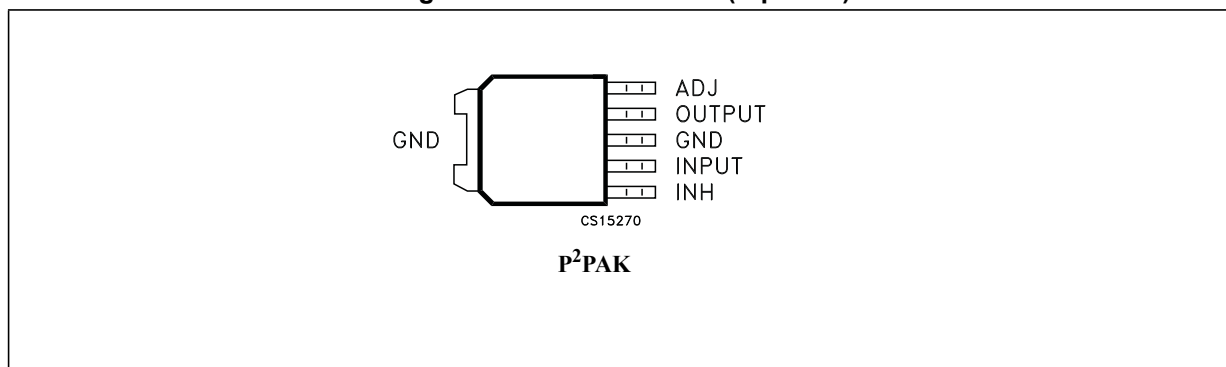

3 Typical application

Figure 3. Application circuit

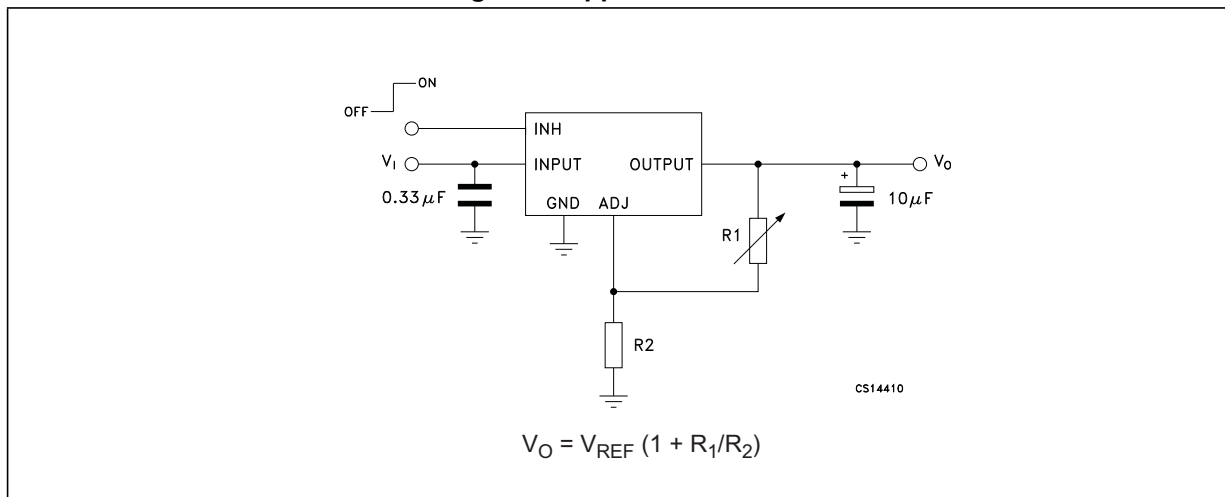

4 Maximum ratings

Table 2. Absolute maximum ratings

Symbol	Parameter	Value	Unit
V_I	DC input voltage	30 ⁽¹⁾	V
I_O	Output current	Internally limited	mA
P_D	Power dissipation	Internally limited	mW
T_{STG}	Storage temperature range	- 55 to 150	°C
T_{OP}	Operating junction temperature range	- 40 to 125	°C

1. Above 14 V the device is automatically in shutdown.

Note: **Absolute maximum ratings are those values beyond which damage to the device may occur. Functional operation under these conditions is not implied.**

Table 3. Thermal data

Symbol	Parameter	P ² PAK	Unit
R_{thJA}	Thermal resistance junction-ambient	60	°C/W
R_{thJC}	Thermal resistance junction-case	3	°C/W

5 Electrical characteristics

$I_O = 10 \text{ mA}$, $T_J = 25 \text{ °C}$, $V_I = 3.23 \text{ V}$, $V_{INH} = 2 \text{ V}$, $C_I = 330 \text{ nF}$, $C_O = 10 \text{ }\mu\text{F}$ adjust pin tied to output pin.

Table 4. Electrical characteristics of LD29300#ADJ

Symbol	Parameter	Test conditions	Min.	Typ.	Max.	Unit
V_I	Minimum operating input voltage	$I_O = 10 \text{ mA}$ to 3 A , $T_J = -40$ to 125 °C	2.5			V
ΔV_O	Load regulation	$I_O = 10 \text{ mA}$ to 3 A		0.2	1.0	%
ΔV_O	Line regulation	$V_I = 2.5 \text{ V}$ to 13 V		0.06	0.5	%
V_{REF}	Reference voltage	$I_O = 10 \text{ mA}$ to 3 A , $V_I = 2.5$ to 4.5 V $T_J = -40$ to 125 °C ⁽¹⁾	-1%	1.23	+1%	V
			-2%		+2%	
SVR	Supply voltage rejection	$f = 120 \text{ Hz}$, $V_I = 3.23 \pm 1 \text{ V}$, $I_O = 1.5\text{ A}$ ⁽²⁾	65	75		dB
I_q	Quiescent current	$I_O = 1.5 \text{ A}$, $T_J = -40$ to 125 °C		20	50	mA
		$I_O = 3 \text{ A}$, $T_J = -40$ to 125 °C		45	100	
		$V_I = 13 \text{ V}$, $V_{INH} = \text{GND}$, $T_J = -40$ to 125 °C		130	180	μA
I_{ADJ}	Adjust pin current	$T_J = -40$ to 125 °C			1	μA
I_{sc}	Short circuit current	$V_I - V_O = 5.5 \text{ V}$		4.5		A
V_{IL}	Control input logic low	OFF MODE ⁽¹⁾ , $T_J = -40$ to 125 °C			0.8	V
V_{IH}	Control input logic high	ON MODE ⁽¹⁾ , $T_J = -40$ to 125 °C	2			V
I_{INH}	Control input current	$T_J = -40$ to 125 °C , $V_{INH} = 13 \text{ V}$		5	10	μA
eN	Output noise voltage	$B_P = 10 \text{ Hz}$ to 100 kHz , $I_O = 100 \text{ mA}$ ⁽²⁾		50		μV_{RMS}

1. Reference voltage is measured between output and GND pin, with ADJ PIN tied to V_{OUT} .

2. Guaranteed by design.

6 Typical characteristics

Figure 4. Output voltage vs. temperature

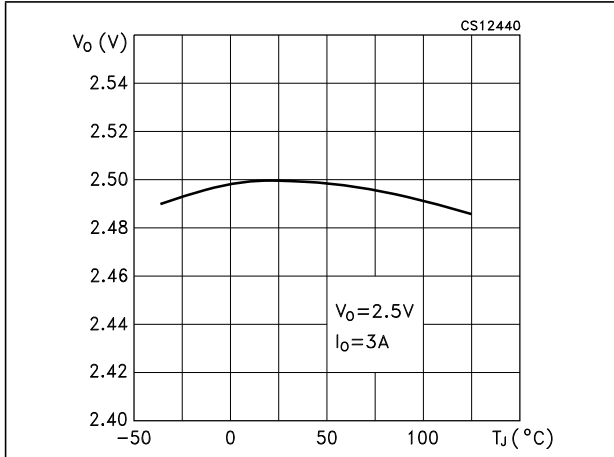

Figure 5. Dropout voltage vs. temperature

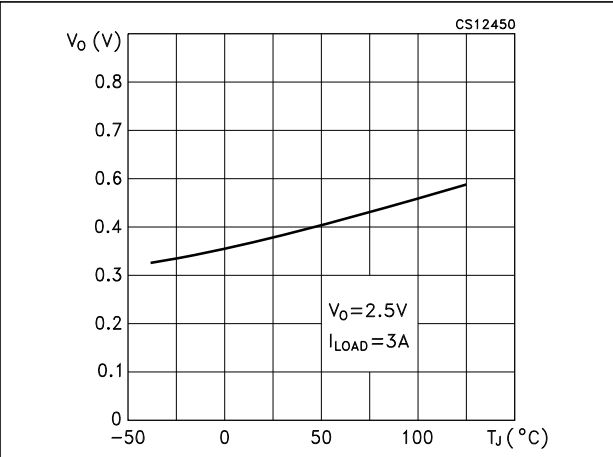

Figure 6. Dropout voltage vs. output current

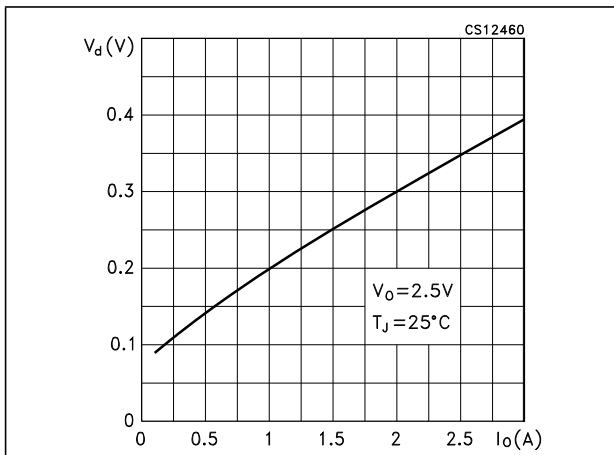

Figure 7. Quiescent current vs. output current ($V_I = 13V$)

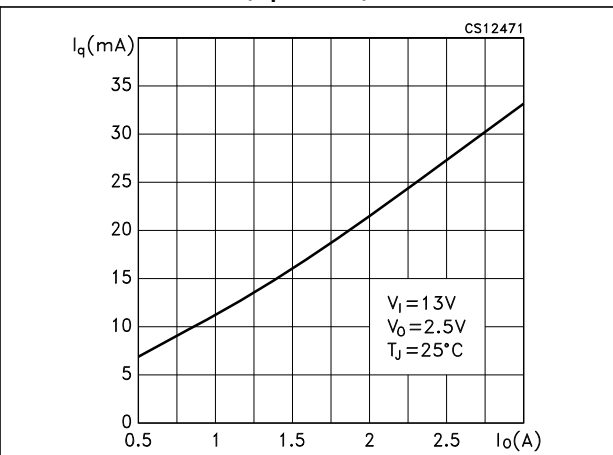

Figure 8. Quiescent current vs. output current ($V_I = 4.5\text{ V}$)

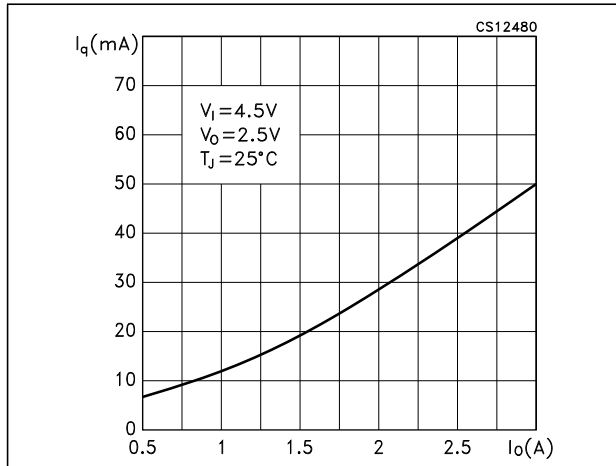

Figure 9. Quiescent current vs. supply voltage

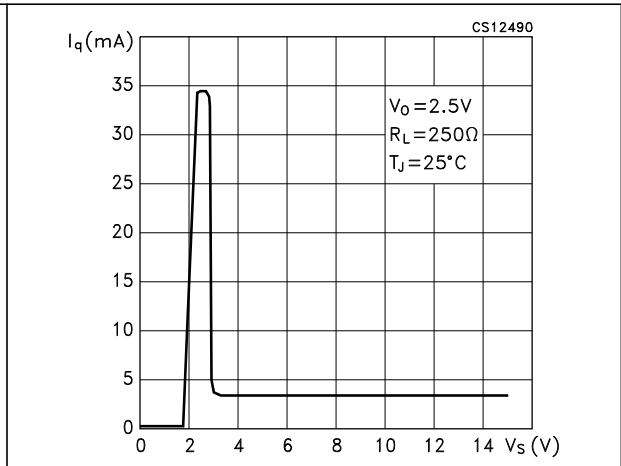

Figure 10. Quiescent current vs. temperature ($I_o = 100\text{ mA}$)

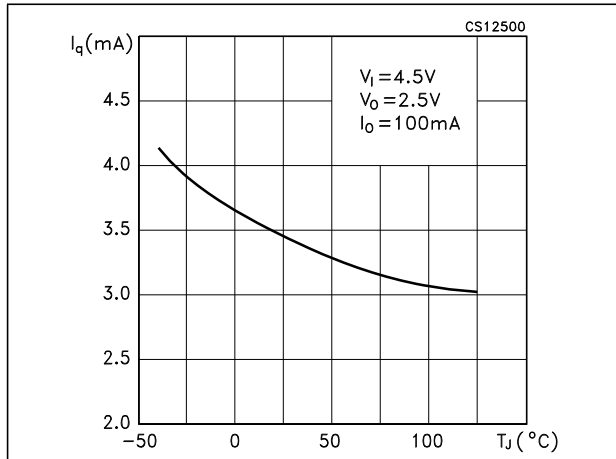

Figure 11. Quiescent current vs. temperature ($I_o = 3\text{ A}$)

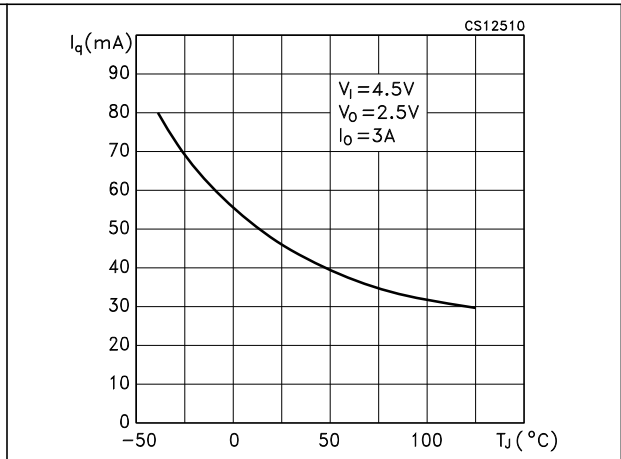

Figure 12. Short circuit current vs. temperature

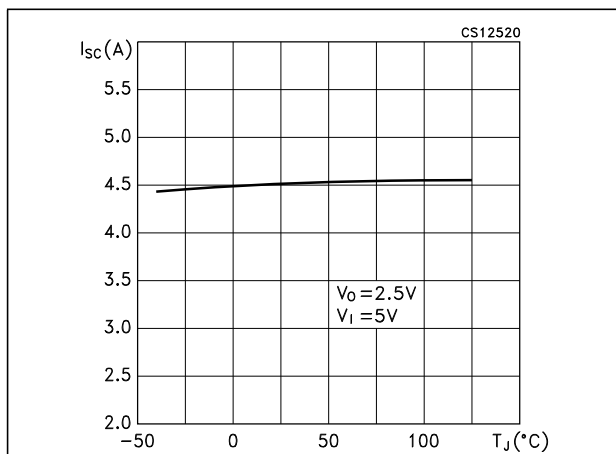

Figure 13. Supply voltage rejection vs. temperature

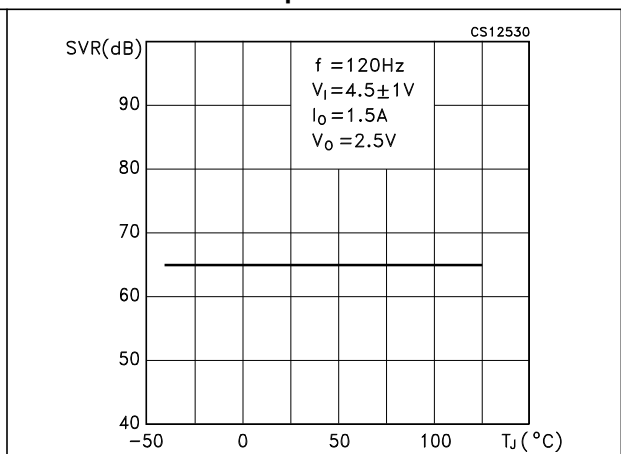

Figure 14. Stability vs. C_O

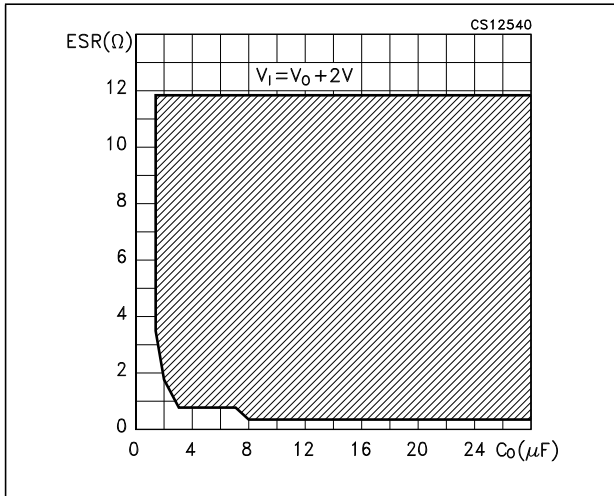

Figure 15. Line transient

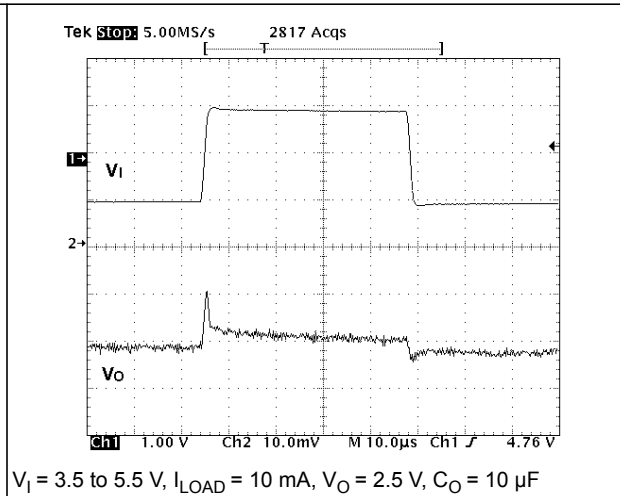
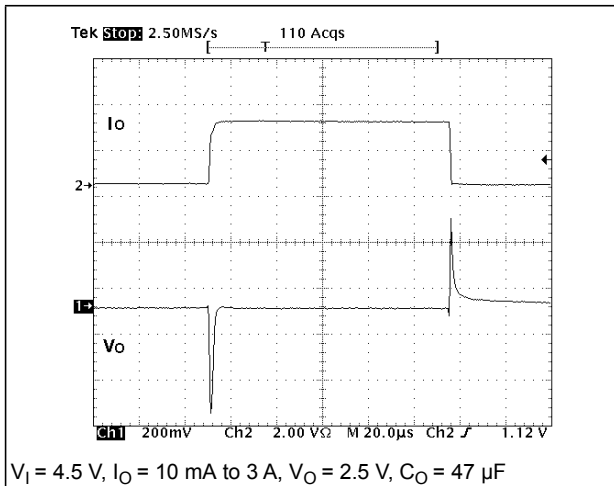

Figure 16. Load transient



7 Package information

In order to meet environmental requirements, ST offers these devices in different grades of ECOPACK[®] packages, depending on their level of environmental compliance. ECOPACK[®] specifications, grade definitions and product status are available at: www.st.com. ECOPACK[®] is an ST trademark.

7.1 P²PAK package information

Table 5. P²PAK mechanical data

Dim.	mm		
	Min.	Typ.	Max.
A	4.30		4.80
A2	0.03		0.23
C	1.17		1.37
D	2.40		2.80
D1	8.95		9.35
E	0.45		0.60
F	0.80		1.05
G	3.20		3.60
G1	6.60		7.00
H1		8.5	
H2	10.00		10.40
L	15		15.85
L1		8	
L2	1.27		1.40
M	2.4		3.2
R		0.40	
V2	0°		8°

Figure 17. P²PAK outline

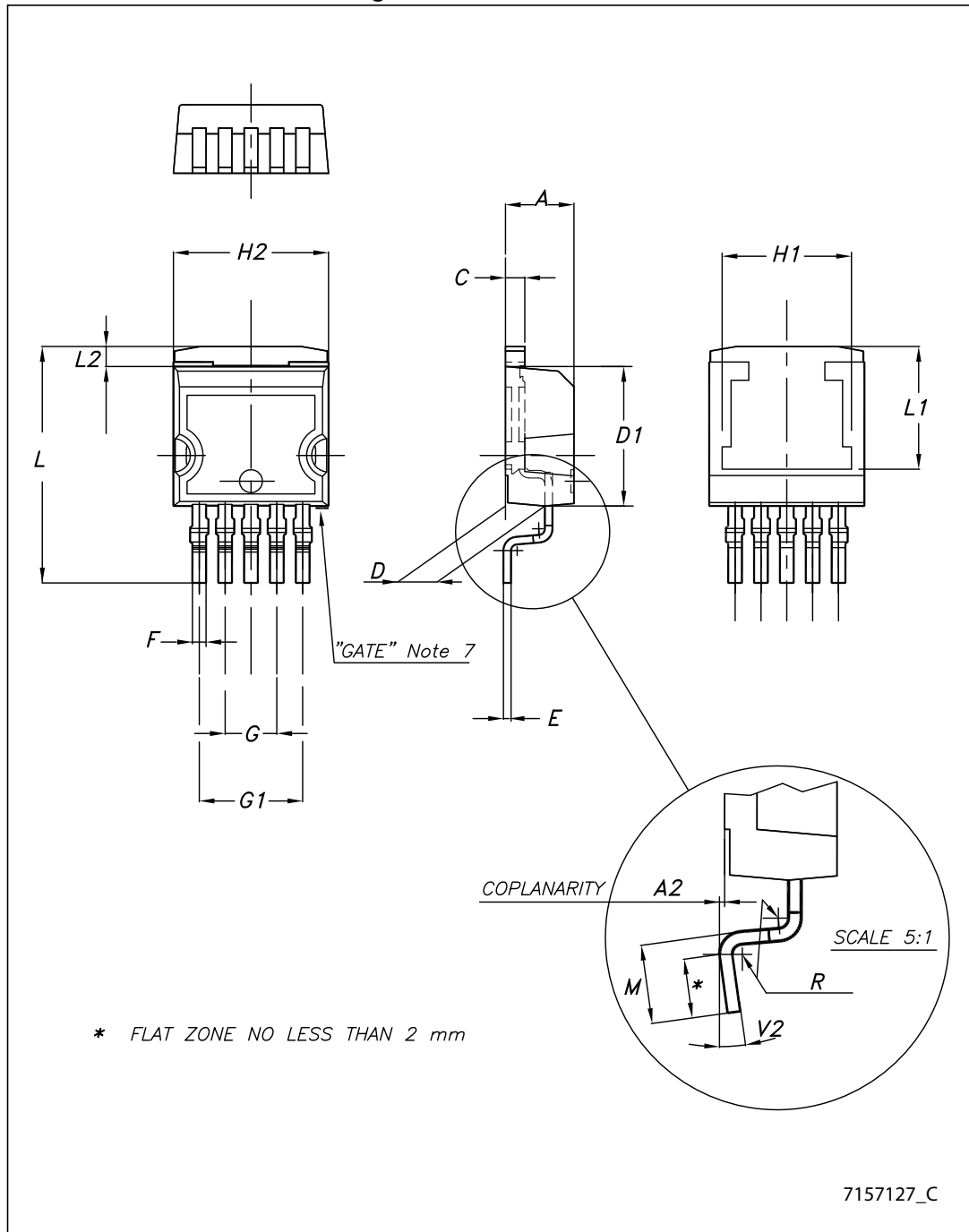
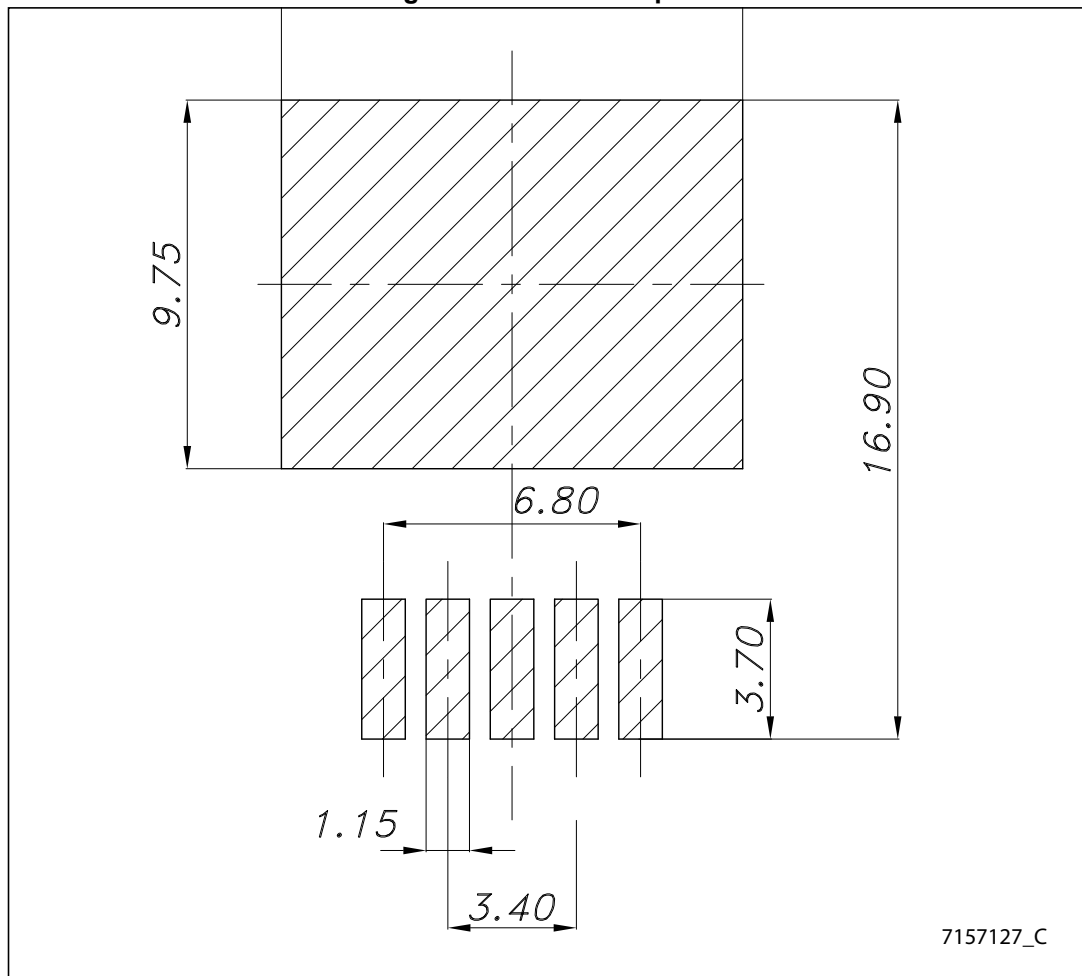

Figure 18. P²PAK footprint



7157127_C

8 Packaging information

8.1 P²PAK packaging information

Table 6. P²PAK tape and reel mechanical data

Dim.	mm		
	Min.	Typ.	Max.
A			180
C	12.8	13	13.2
D	20.2		
N	60		
T			14.4
Ao	10.50	10.6	10.70
Bo	15.70	15.80	15.90
Ko	4.80	4.90	5.00
Po	3.9	4.0	4.1
P	11.9	12.0	12.1

Figure 19. P²PAK tape and reel dimensions

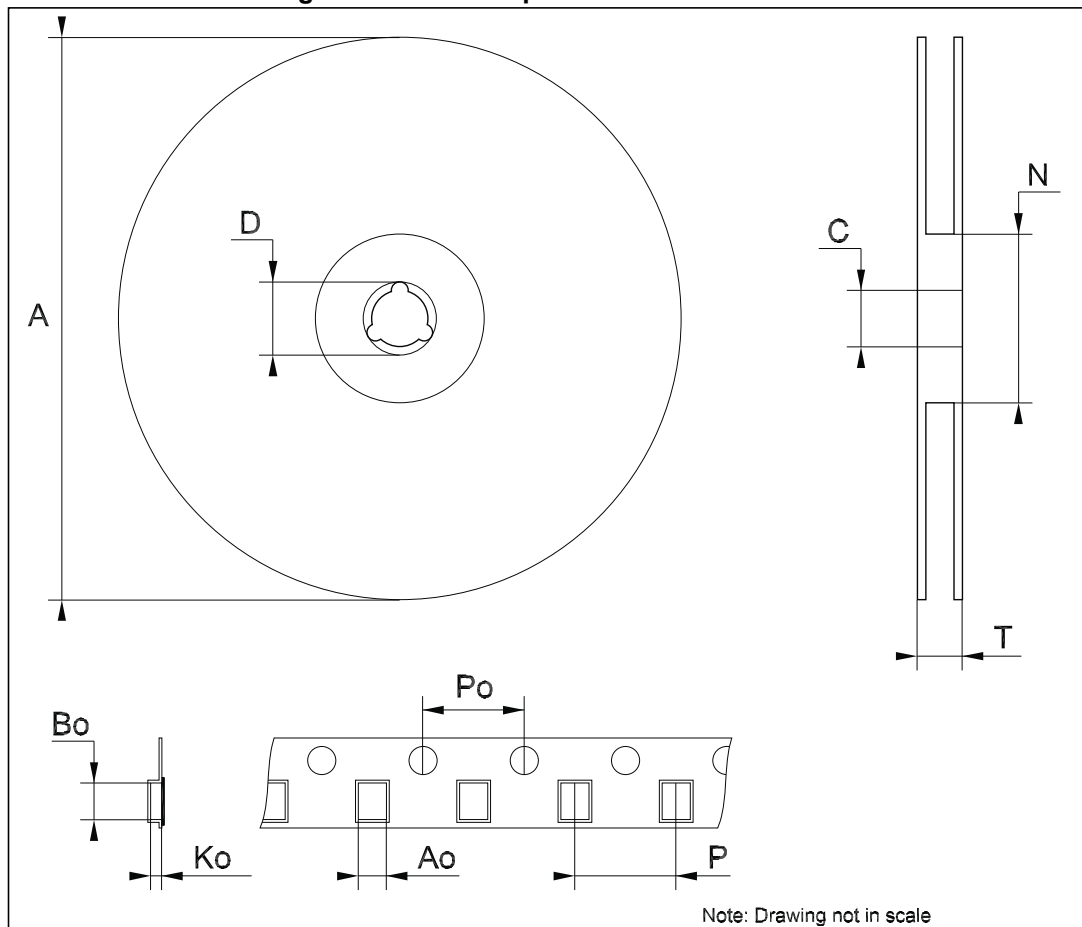

9 Revision history

Table 7. Document revision history

Date	Revision	Changes
21-Oct-2005	7	Order codes updated.
10-Apr-2007	8	Order codes updated.
11-May-2007	9	Order codes updated.
08-Jun-2007	10	Order codes updated.
03-Apr-2008	11	Modified: Table 1 on page 1 .
11-Jul-2008	12	Modified: Table 1 on page 1 .
13-Sep-2012	13	Updated: Table 1 on page 1 .
18-Nov-2013	14	Part numbers LD29300XX, LD29300XX18 and LD29300XX33 have been changed to LD29300. Updated the Description in cover page and Table 1: Device summary . Updated Table 3: Thermal data , Section 5: Electrical characteristics and Section 7: Package mechanical data . Added Section 8: Packaging mechanical data . Minor text changes.
30-Aug-2017	15	Removed version of device with fixed output voltage (updated Features , Table 1: Device summary , removed schematic and electrical characteristics, updated Figure 2: Pin connections (top view) , Figure 3: Application circuit) Minor textual updates

IMPORTANT NOTICE – PLEASE READ CAREFULLY

STMicroelectronics NV and its subsidiaries ("ST") reserve the right to make changes, corrections, enhancements, modifications, and improvements to ST products and/or to this document at any time without notice. Purchasers should obtain the latest relevant information on ST products before placing orders. ST products are sold pursuant to ST's terms and conditions of sale in place at the time of order acknowledgement.

Purchasers are solely responsible for the choice, selection, and use of ST products and ST assumes no liability for application assistance or the design of Purchasers' products.

No license, express or implied, to any intellectual property right is granted by ST herein.

Resale of ST products with provisions different from the information set forth herein shall void any warranty granted by ST for such product.

ST and the ST logo are trademarks of ST. All other product or service names are the property of their respective owners.

Information in this document supersedes and replaces information previously supplied in any prior versions of this document.

© 2017 STMicroelectronics – All rights reserved







Looking for pricing, stock, or lifecycle information?

Click below to explore more details on WIN SOURCE:

 [View LD29300D2T33R on WIN SOURCE](#)

 [STMicroelectronics](#) Information

Optimize Your Supply Chain with WIN SOURCE Solutions

-  Global Sourcing Solution
-  Obsolete Management
-  Cost Control Management
-  Shortage Management
-  Alternative Solution
-  Excess Inventory Management