



**THE DATASHEET OF  
LD2979M38TR**



## Very low drop voltage regulators with inhibit

Datasheet - production data

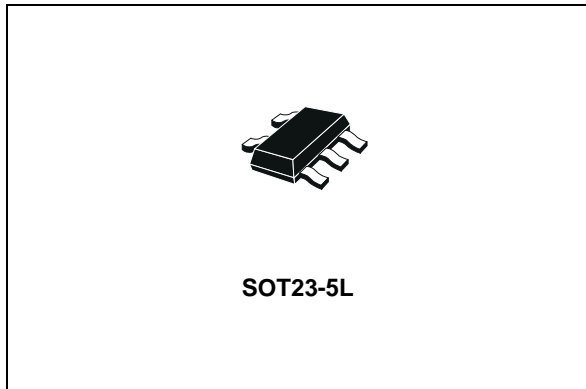

### Description

The LD2979 is a very low drop regulator available in SOT23-5L.

The very low drop-voltage and the very low quiescent current make them particularly suitable for low noise, low power applications and in battery powered systems.

Shutdown logic control function is available on five pin version (TTL compatible). This means that when the device is used as local regulator, it is possible to put a part of the board in standby, decreasing the total power consumption.

### Features

- Very low dropout voltage (0.2 V typ. at 50 mA load)
- Very low quiescent current (typ. 500  $\mu$ A at 50 mA load)
- Output current up to 50 mA
- Logic-controlled electronic shutdown
- Output voltages of 3.0 and 3.3 V
- Internal current and thermal limit
- Supply voltage rejection: 63 dB (typ)
- Only 1  $\mu$ F for stability
- Temperature range: -25 °C to 125 °C
- Package available: SOT23-5L

**Table 1. Device summary**

Order codes	Output voltages
LD2979M30TR	3.0 V
LD2979M33TR	3.3 V

---

# Contents

1	Diagram .....	3
2	Pin configuration .....	4
3	Maximum ratings .....	5
4	Electrical characteristics .....	6
5	Typical characteristics .....	7
6	Package mechanical data .....	10
7	Packaging mechanical data .....	12
8	Revision history .....	14

# 1 Diagram

Figure 1. Schematic diagram

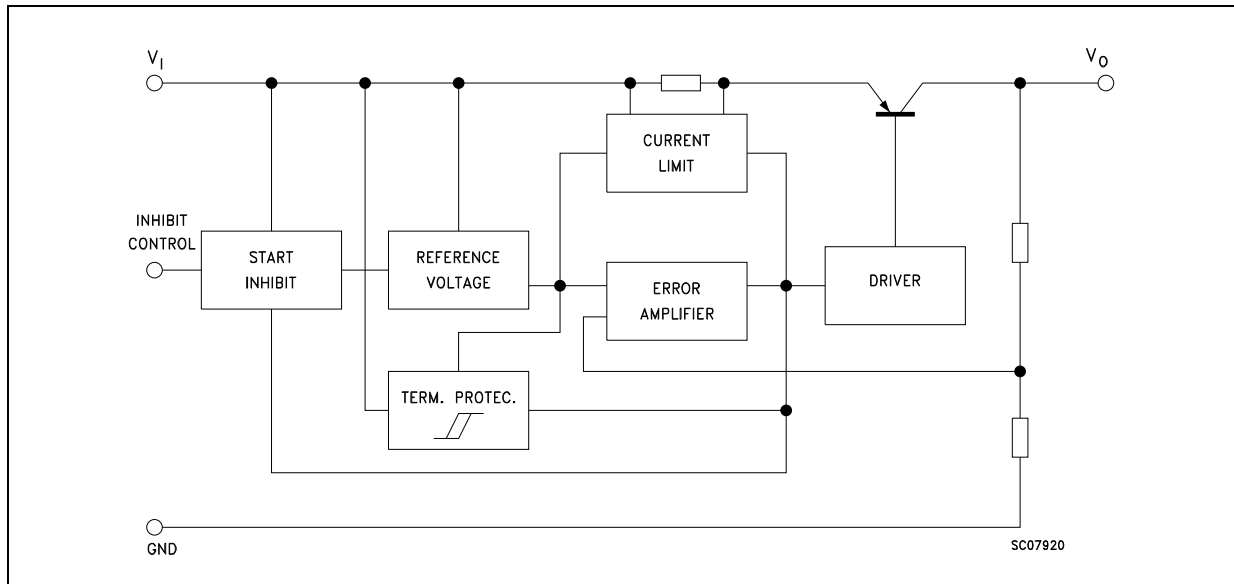

## 2 Pin configuration

Figure 2. Pin connections (top view)

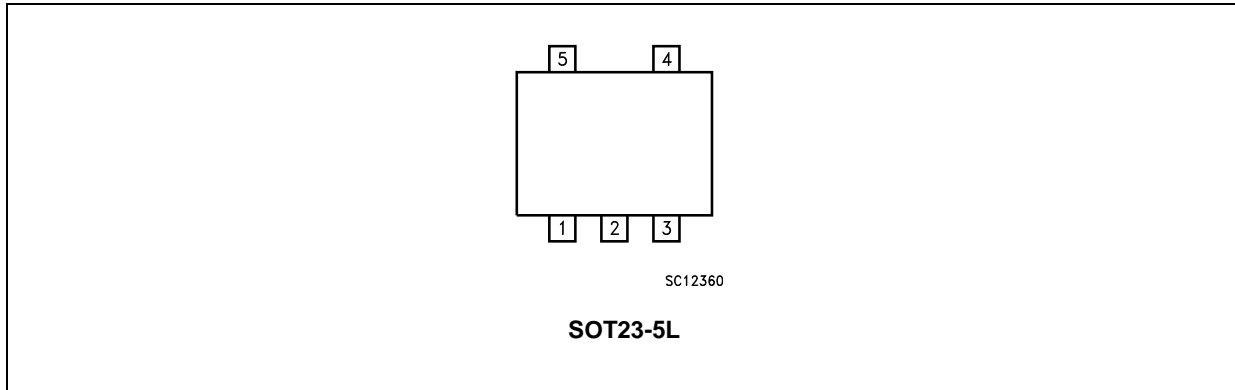

Table 2. Pin description

Symbol	Name and function	Pin number
$V_I$	Input voltage	1
GND	Ground	2
INHIBIT	Control switch ON/OFF <sup>(1)</sup>	3
NC	Not to be connected	4
$V_O$	Output voltage	5

1. Inhibit pin is not internally pulled-up then it must not be left floating. Connect to a positive voltage higher than 2 V to able the device.

### 3 Maximum ratings

**Table 3. Absolute maximum ratings**

Symbol	Parameter	Value	Unit
$V_I$	DC input voltage	16	V
$V_{INH}$	DC inhibit input voltage	$V_{IN}$	V
$I_O$	Output current	Internally limited	
$P_D$	Power dissipation	Internally limited	
$T_{STG}$	Storage temperature range	-40 to 150	°C
$T_{OP}$	Operating junction temperature range	-25 to 125	°C

*Note: Absolute maximum ratings are those values beyond which damage to the device may occur. Functional operation under these condition is not implied.*

## 4 Electrical characteristics

(Refer to the test circuits,  $T_a = 25\text{ }^\circ\text{C}$ ,  $V_{IN} = V_{O(NOM)} + 1\text{ V}$ ,  $I_O = 1\text{ mA}$ ,  $V_{INH} = 2\text{ V}$ ,  $C_O = 1\text{ }\mu\text{F}$ , unless otherwise specified).

**Table 4. Electrical characteristics**

Symbol	Parameter	Test conditions	Min.	Typ.	Max.	Unit
$V_O$	Output voltage	$V_{IN} = 4\text{ V}$	2.940	3	3.060	V
		$I_O = 1\text{ to }50\text{ mA}$ , $T_a = -25\text{ to }125\text{ }^\circ\text{C}$	2.880		3.120	
$V_O$	Output voltage	$V_{IN} = 4.3\text{ V}$	3.234	3.3	3.366	V
		$I_O = 1\text{ to }50\text{ mA}$ , $T_a = -25\text{ to }125\text{ }^\circ\text{C}$	3.168		3.432	
$I_O$	Output current limit		100			mA
$\Delta V_O$	Line regulation	$V_{IN} = V_{O(NOM)} + 1\text{V to }16\text{V}$ , $I_O = 1\text{ mA}$			0.028	%/ $V_{IN}$
		$T_a = -25\text{ to }125\text{ }^\circ\text{C}$			0.064	
$I_d$	Quiescent current (On Mode)	$I_O = 0$		80	110	$\mu\text{A}$
		$I_O = 0$ , $T_a = -25\text{ to }125\text{ }^\circ\text{C}$			170	
		$I_O = 50\text{ mA}$		500	700	
		$I_O = 50\text{ mA}$ , $T_a = -25\text{ to }125\text{ }^\circ\text{C}$			1300	
	Quiescent current (Off Mode)	$V_{INH} < 0.18\text{ V}$		0		$\mu\text{A}$
		$V_{INH} < 0.18\text{ V}$ , $T_a = -25\text{ to }125\text{ }^\circ\text{C}$			1	
SVR	Supply voltage rejection	$I_O = 50\text{ mA}$ , $C_{OUT} = 10\text{ }\mu\text{F}$ , $f = 120\text{ Hz}$		63		dB
$V_d$	Dropout voltage	$I_O = 0$		6	12	mV
		$I_O = 0$ , $T_a = -25\text{ to }125\text{ }^\circ\text{C}$			18	
		$I_O = 1\text{ mA}$		30	60	
		$I_O = 1\text{ mA}$ , $T_a = -25\text{ to }125\text{ }^\circ\text{C}$			90	
		$I_O = 10\text{ mA}$		100	200	
		$I_O = 10\text{ mA}$ , $T_a = -25\text{ to }125\text{ }^\circ\text{C}$			300	
		$I_O = 50\text{ mA}$		200	400	
		$I_O = 50\text{ mA}$ , $T_a = -25\text{ to }125\text{ }^\circ\text{C}$			600	
$V_{IL}$	Inhibit input logic low	Device Off, $T_a = -25\text{ to }125\text{ }^\circ\text{C}$			0.18	V
$V_{IH}$	Inhibit input logic high	Device On, $T_a = -25\text{ to }125\text{ }^\circ\text{C}$	2			V
$I_I$	Inhibit input current	$V_{INH} = 0\text{ V}$		0	-1	$\mu\text{A}$
		$V_{INH} = 5\text{ V}$ , $T_a = -25\text{ to }125\text{ }^\circ\text{C}$		5	15	
eN	Output noise voltage (RMS)	$\text{BW} = 300\text{ Hz to }50\text{ kHz}$ , $C_O = 10\text{ }\mu\text{F}$		160		$\mu\text{V}$

## 5 Typical characteristics

(unless otherwise specified  $T_A = 25\text{ }^\circ\text{C}$ )

**Figure 3. Output voltage vs temperature**

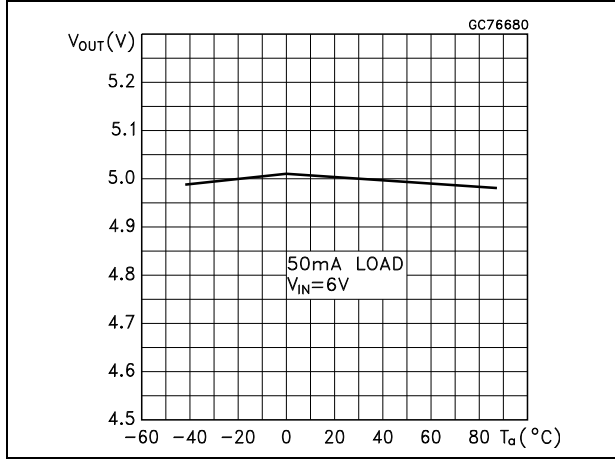

**Figure 4. Output voltage vs input voltage**

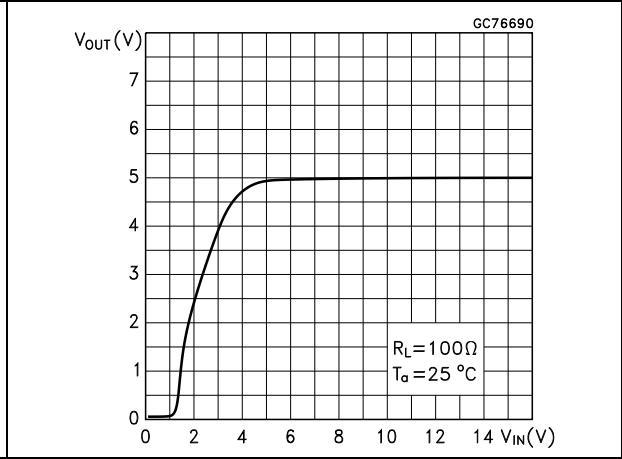

**Figure 5. Output voltage vs input voltage**

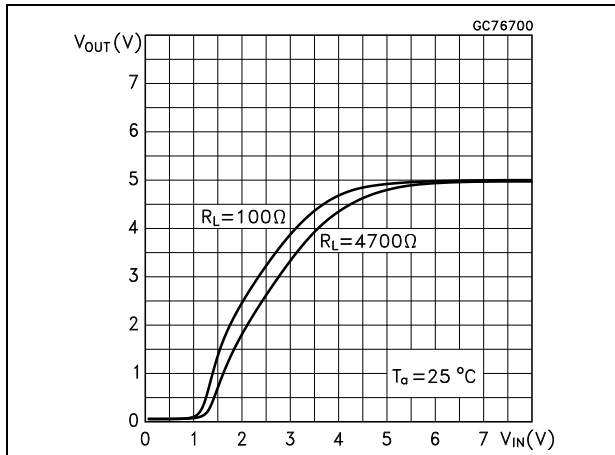

**Figure 6. Dropout voltage vs output current**

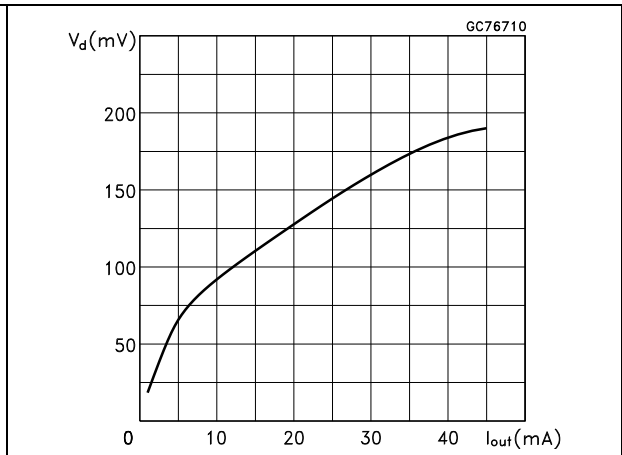

**Figure 7. Dropout voltage vs temperature**

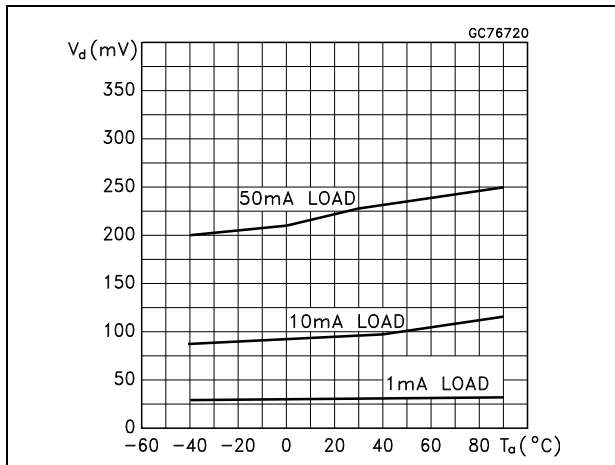

**Figure 8. Quiescent current vs temperature**

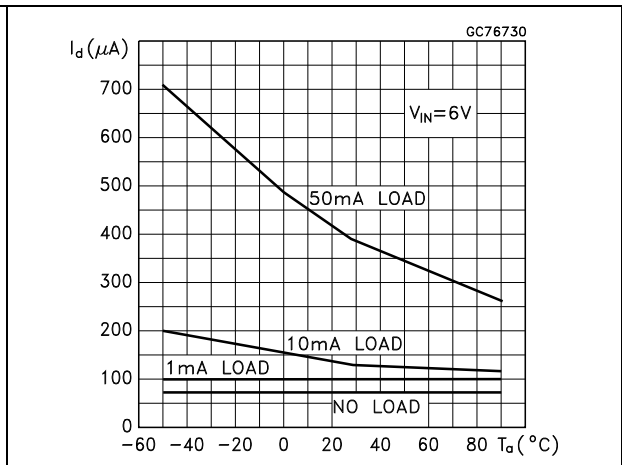

Figure 9. Short circuit current vs dropout voltage

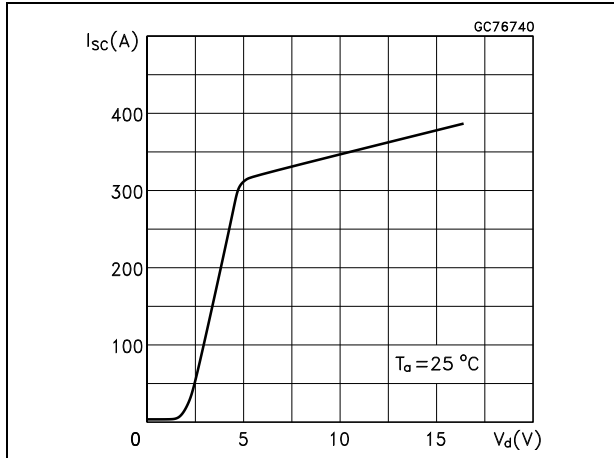

Figure 10. Inhibit voltage vs temperature

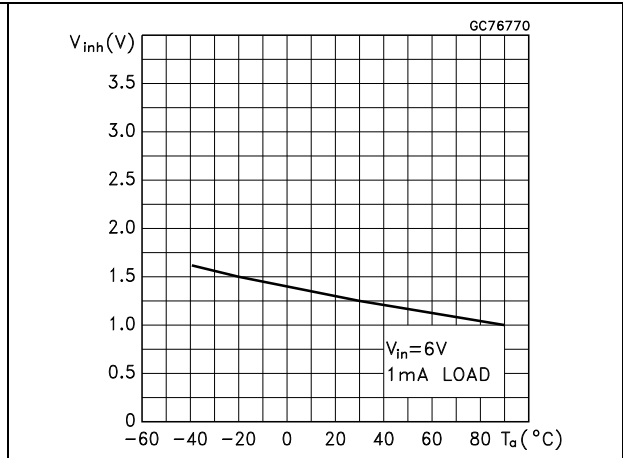

Figure 11. Supply voltage rejection vs frequency

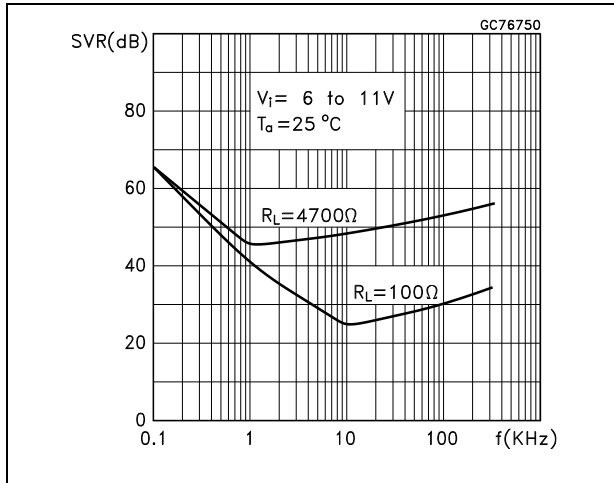

Figure 12. Load transient response

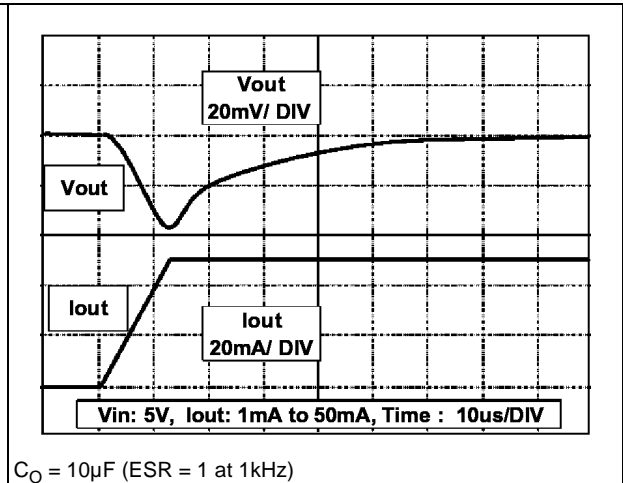

Figure 13. Inhibit current vs temperature

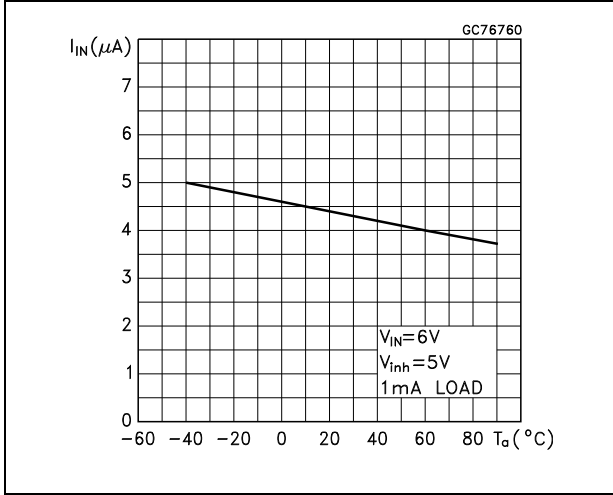

Figure 14. Load transient response

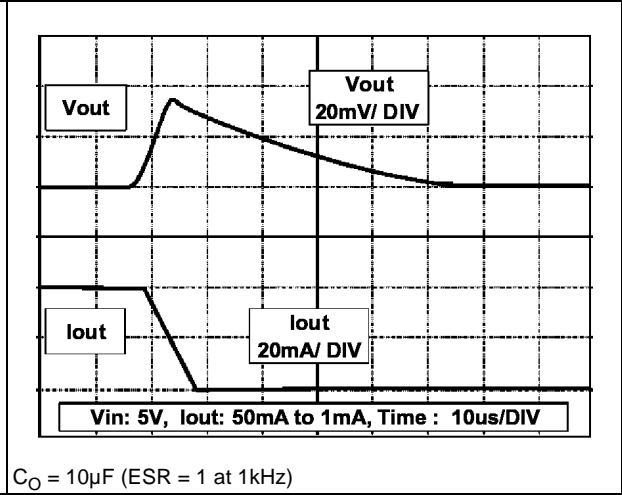
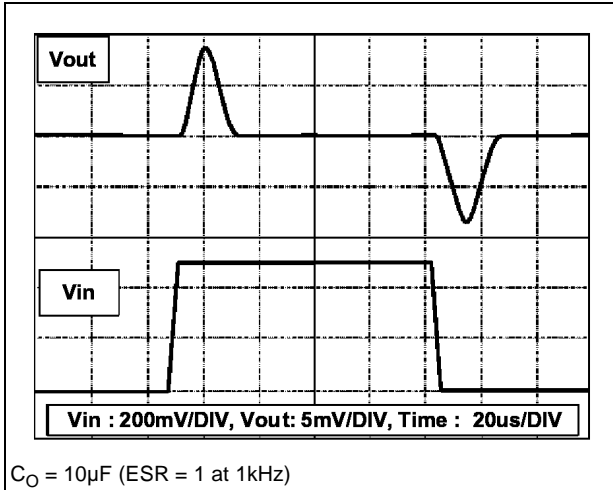

Figure 15. Line transient response



## 6 Package mechanical data

In order to meet environmental requirements, ST offers these devices in different grades of ECOPACK<sup>®</sup> packages, depending on their level of environmental compliance. ECOPACK<sup>®</sup> specifications, grade definitions and product status are available at: [www.st.com](http://www.st.com). ECOPACK<sup>®</sup> is an ST trademark.

Table 5. SOT23-5L mechanical data

Dim.	mm		
	Min.	Typ.	Max.
A	0.90		1.45
A1	0		0.15
A2	0.90		1.30
b	0.30		0.50
c	2.09		0.20
D		2.95	
E		1.60	
e		0.95	
H		2.80	
L	0.30		0.60
$\theta$	0		8

Figure 16. SOT23-5L mechanical drawing

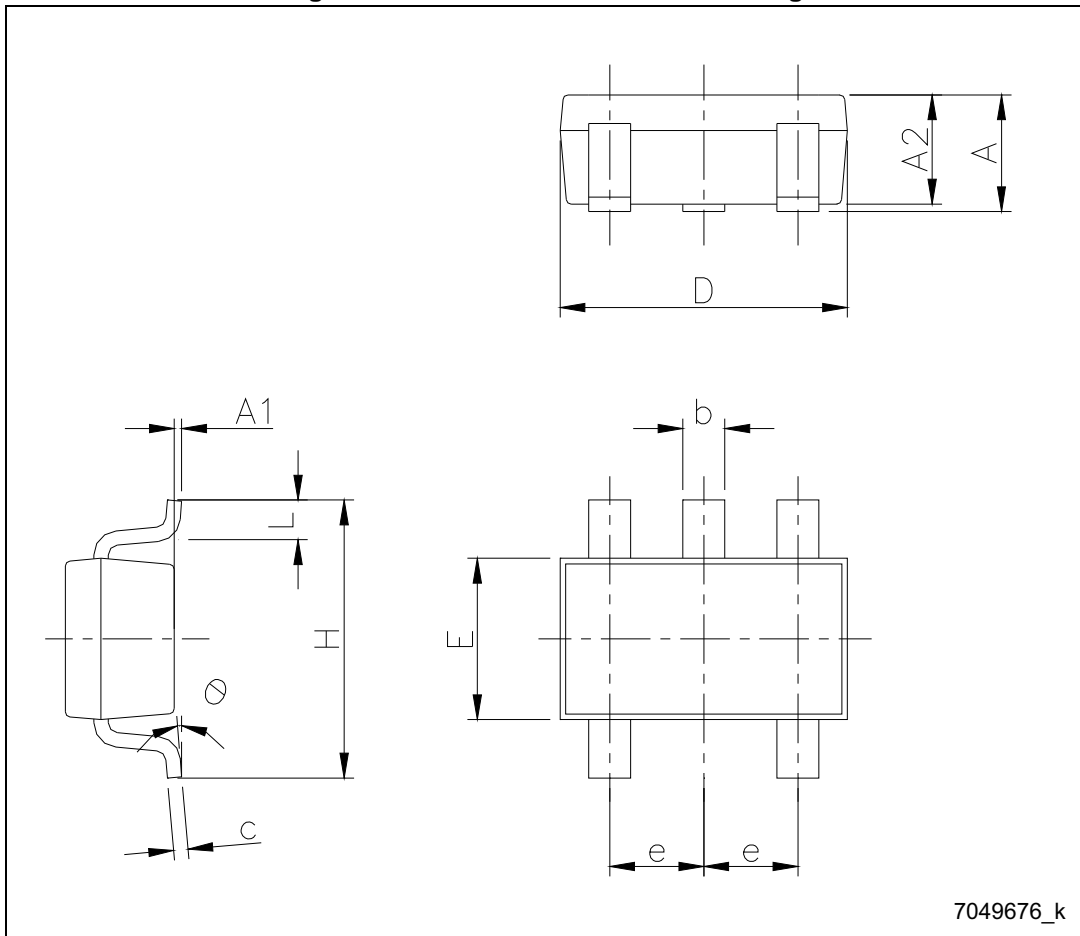

7049676\_k

Figure 17. SOT23-5L recommended footprint (dimensions in mm)

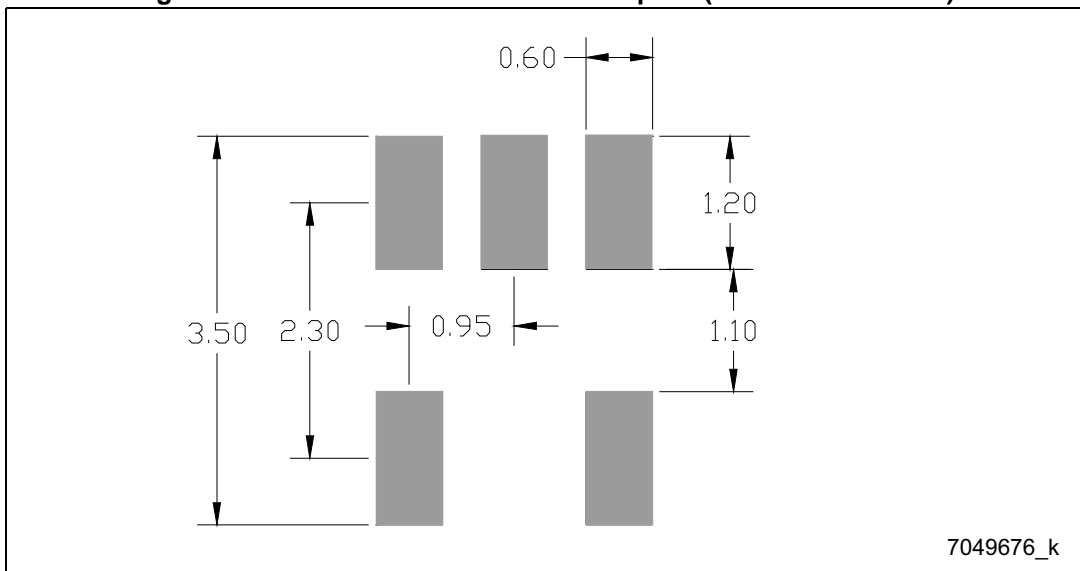

7049676\_k

## 7 Packaging mechanical data

**Table 6. Tape and reel SOT23-5L mechanical data**

Dim.	mm		
	Min.	Typ.	Max.
A			180
C	12.8	13.0	13.2
D	20.2		
N	60		
T			14.4
Ao	3.13	3.23	3.33
Bo	3.07	3.17	3.27
Ko	1.27	1.37	1.47
Po	3.9	4.0	4.1
P	3.9	4.0	4.1

Figure 18. Tape and reel SOT23-5L mechanical drawing

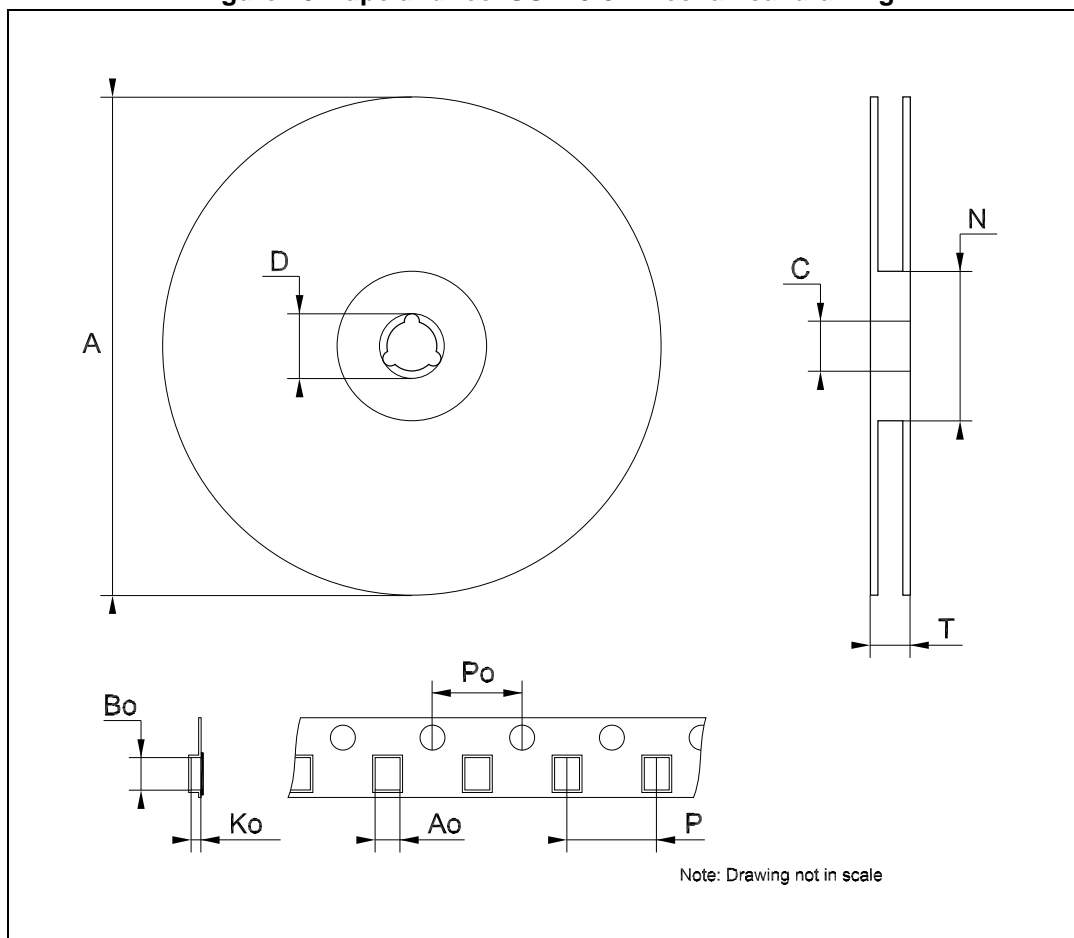

## 8 Revision history

**Table 7. Document revision history**

Date	Revision	Changes
15-Mar-2005	10	Add tape & reel for TO-92.
03-Jul-2006	11	Order codes updated.
16-May-2007	12	Order codes updated.
08-Jun-2007	13	Order codes updated.
09-Apr-2008	14	Modified: <a href="#">Table 1 on page 1</a> .
06-Nov-2013	15	Document name changed from LD2979xx to LD2979. Updated <a href="#">Table 1: Device summary</a> , <a href="#">Table 1: Device summary</a> and <a href="#">Section Table 4.: Electrical characteristics</a> . Minor text changes in features and description in cover page.

**Please Read Carefully:**

Information in this document is provided solely in connection with ST products. STMicroelectronics NV and its subsidiaries ("ST") reserve the right to make changes, corrections, modifications or improvements, to this document, and the products and services described herein at any time, without notice.

All ST products are sold pursuant to ST's terms and conditions of sale.

Purchasers are solely responsible for the choice, selection and use of the ST products and services described herein, and ST assumes no liability whatsoever relating to the choice, selection or use of the ST products and services described herein.

No license, express or implied, by estoppel or otherwise, to any intellectual property rights is granted under this document. If any part of this document refers to any third party products or services it shall not be deemed a license grant by ST for the use of such third party products or services, or any intellectual property contained therein or considered as a warranty covering the use in any manner whatsoever of such third party products or services or any intellectual property contained therein.

**UNLESS OTHERWISE SET FORTH IN ST'S TERMS AND CONDITIONS OF SALE ST DISCLAIMS ANY EXPRESS OR IMPLIED WARRANTY WITH RESPECT TO THE USE AND/OR SALE OF ST PRODUCTS INCLUDING WITHOUT LIMITATION IMPLIED WARRANTIES OF MERCHANTABILITY, FITNESS FOR A PARTICULAR PURPOSE (AND THEIR EQUIVALENTS UNDER THE LAWS OF ANY JURISDICTION), OR INFRINGEMENT OF ANY PATENT, COPYRIGHT OR OTHER INTELLECTUAL PROPERTY RIGHT.**

**ST PRODUCTS ARE NOT DESIGNED OR AUTHORIZED FOR USE IN: (A) SAFETY CRITICAL APPLICATIONS SUCH AS LIFE SUPPORTING, ACTIVE IMPLANTED DEVICES OR SYSTEMS WITH PRODUCT FUNCTIONAL SAFETY REQUIREMENTS; (B) AERONAUTIC APPLICATIONS; (C) AUTOMOTIVE APPLICATIONS OR ENVIRONMENTS, AND/OR (D) AEROSPACE APPLICATIONS OR ENVIRONMENTS. WHERE ST PRODUCTS ARE NOT DESIGNED FOR SUCH USE, THE PURCHASER SHALL USE PRODUCTS AT PURCHASER'S SOLE RISK, EVEN IF ST HAS BEEN INFORMED IN WRITING OF SUCH USAGE, UNLESS A PRODUCT IS EXPRESSLY DESIGNATED BY ST AS BEING INTENDED FOR "AUTOMOTIVE, AUTOMOTIVE SAFETY OR MEDICAL" INDUSTRY DOMAINS ACCORDING TO ST PRODUCT DESIGN SPECIFICATIONS. PRODUCTS FORMALLY ESCC, QML OR JAN QUALIFIED ARE DEEMED SUITABLE FOR USE IN AEROSPACE BY THE CORRESPONDING GOVERNMENTAL AGENCY.**

Resale of ST products with provisions different from the statements and/or technical features set forth in this document shall immediately void any warranty granted by ST for the ST product or service described herein and shall not create or extend in any manner whatsoever, any liability of ST.

ST and the ST logo are trademarks or registered trademarks of ST in various countries.

Information in this document supersedes and replaces all information previously supplied.

The ST logo is a registered trademark of STMicroelectronics. All other names are the property of their respective owners.

© 2013 STMicroelectronics - All rights reserved

STMicroelectronics group of companies



Australia - Belgium - Brazil - Canada - China - Czech Republic - Finland - France - Germany - Hong Kong - India - Israel - Italy - Japan - Malaysia - Malta - Morocco - Philippines - Singapore - Spain - Sweden - Switzerland - United Kingdom - United States of America

[www.st.com](http://www.st.com)



## Looking for pricing, stock, or lifecycle information?

Click below to explore more details on WIN SOURCE:

-  [View LD2979M38TR](#) on WIN SOURCE
-  [STMicroelectronics](#) Information

## Optimize Your Supply Chain with WIN SOURCE Solutions

-  Global Sourcing Solution
-  Obsolete Management
-  Cost Control Management
-  Shortage Management
-  Alternative Solution
-  Excess Inventory Management