



**THE DATASHEET OF  
LD39015M18R**



**150 mA low quiescent current and low noise voltage regulator**

Datasheet - production data

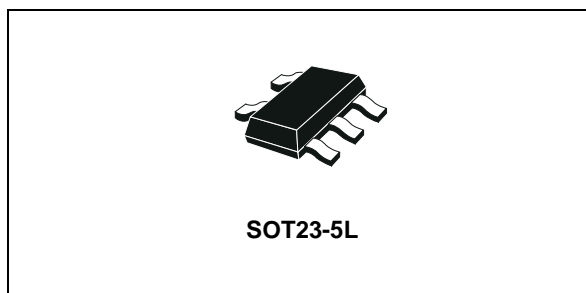

- Compatible with ceramic capacitors  $C_O = 1 \mu\text{F}$
- Internal current and thermal limit
- Temperature range:  $-40 \text{ }^\circ\text{C}$  to  $125 \text{ }^\circ\text{C}$

**Description**

The LD39015 series provides 150 mA maximum current with an input voltage range from 1.5 V to 5.5 V and a typical dropout voltage of 80 mV. It is stable with ceramic capacitors. The ultra low dropout voltage, low quiescent current and low noise features make it suitable for low power battery-powered applications. Power supply rejection is 65 dB at low frequencies and starts rolling off at 10 kHz. Enable logic control function puts the LD39015 in shutdown mode allowing a total current consumption lower than  $1 \mu\text{A}$ . The device also includes short-circuit constant current limiting and thermal protection. Typical applications are mobile phones, personal digital assistants (PDAs), cordless phones or similar battery-powered systems.

**Features**

- Input voltage from 1.5 to 5.5 V
- Ultra low-dropout voltage (80 mV typ. at 100 mA load)
- Very low quiescent current (18  $\mu\text{A}$  typ. at no load, 38  $\mu\text{A}$  typ. at 150 mA load, 1  $\mu\text{A}$  max. in OFF mode)
- Very low noise without bypass capacitor (29  $\mu\text{V}_{\text{RMS}}$  at  $V_{\text{OUT}} = 0.8 \text{ V}$ )
- Output voltage tolerance:  $\pm 2.0\%$  @  $25 \text{ }^\circ\text{C}$
- 150 mA guaranteed output current
- Wide range of output voltages available on request: 0.8 V to 3.3 V with 100 mV step
- Logic-controlled electronic shutdown

**Table 1. Device summary**

Order codes	Output voltages
LD39015M08R	0.8 V
LD39015M10R	1.0 V
LD39015M12R	1.2 V
LD39015M125R	1.25 V
LD39015M15R	1.5 V
LD39015M18R	1.8 V
LD39015M25R	2.5 V
LD39015M33R	3.3 V

# Contents

1	<b>Diagram</b> .....	3
2	<b>Pin configuration</b> .....	4
3	<b>Typical application</b> .....	5
4	<b>Maximum ratings</b> .....	6
5	<b>Electrical characteristics</b> .....	7
6	<b>Typical performance characteristics</b> .....	9
7	<b>Package information</b> .....	11
	7.1 SOT23-5L package information .....	11
	7.2 SOT23-5L packing information .....	13
8	<b>Revision history</b> .....	14

# 1 Diagram

Figure 1. Block diagram

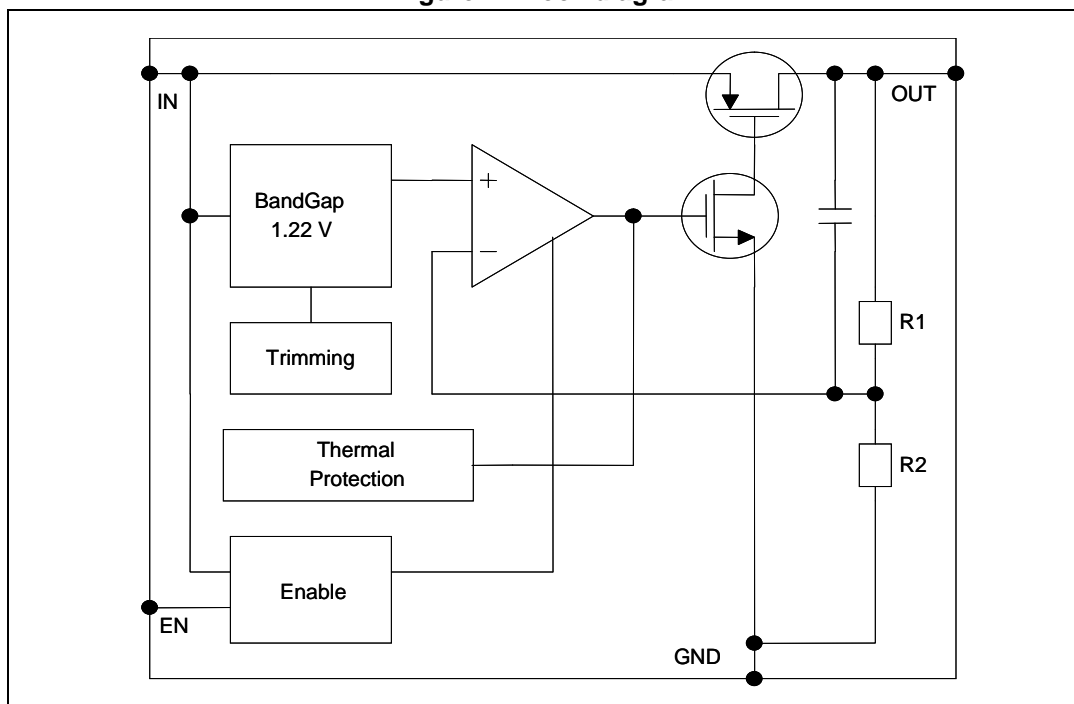

## 2 Pin configuration

Figure 2. Pin connection (top view)

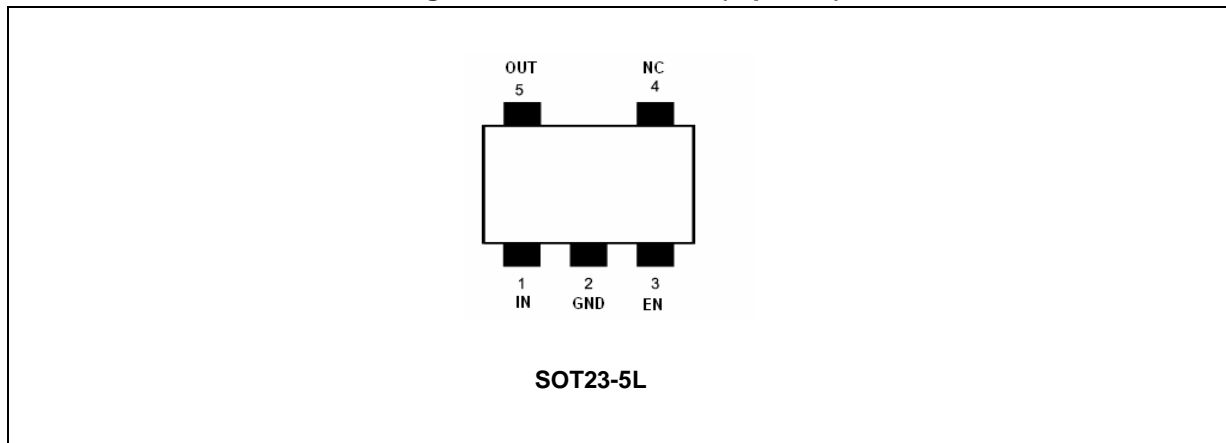
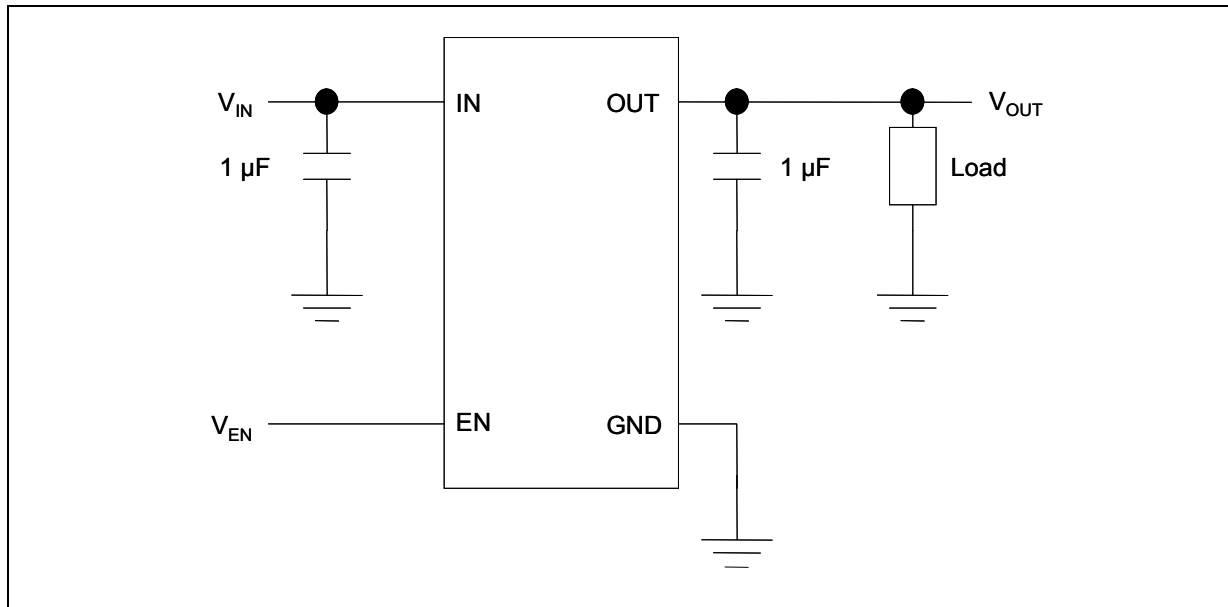

Table 2. Pin description

Pin n°	Symbol	Function
1	IN	LDO input voltage
2	GND	Common ground
3	EN	Enable pin logic input: low = shutdown, high = active
4	NC	Not connected
5	OUT	Output voltage

### 3 Typical application

Figure 3. Typical application circuit



## 4 Maximum ratings

**Table 3. Absolute maximum ratings**

Symbol	Parameter	Value	Unit
$V_{IN}$	DC input voltage	-0.3 to 7	V
$V_{OUT}$	DC output voltage	- 0.3 to $V_I + 0.3$	V
$V_{EN}$	Enable input voltage	- 0.3 to $V_I + 0.3$	V
$I_{OUT}$	Output current	Internally limited	mA
$P_D$	Power dissipation	Internally limited	mW
$T_{STG}$	Storage temperature range	-65 to 150	°C
$T_{OP}$	Operating junction temperature range	-40 to 125	°C

*Note:* Absolute maximum ratings are those values beyond which damage to the device may occur. Functional operation under these conditions is not implied. All values are referred to GND.

**Table 4. Thermal data**

Symbol	Parameter	SOT23-5L	Unit
$R_{thJA}$	Thermal resistance junction-ambient	255	°C/W
$R_{thJC}$	Thermal resistance junction-case	81	°C/W

## 5 Electrical characteristics

$T_J = 25\text{ °C}$ ,  $V_{IN} = V_{OUT(NOM)} + 1\text{ V}$ ,  $C_{IN} = C_{OUT} = 1\text{ }\mu\text{F}$ ,  $I_{OUT} = 1\text{ mA}$ ,  $V_{EN} = V_{IN}$ , unless otherwise specified.

**Table 5. Electrical characteristics (1)**

Symbol	Parameter	Test conditions	Min.	Typ.	Max.	Unit
$V_{IN}$	Operating input voltage		1.5		5.5	V
$V_{UVLO}$	Turn-on threshold			1.45	1.48	V
	Turn-off threshold		1.30	1.35		mV
$V_{OUT}$	$V_{OUT}$ accuracy	$V_{OUT} > 1.5\text{ V}$ , $I_{OUT} = 1\text{ mA}$ $T_J = 25\text{ °C}$	-2.0		2.0	%
		$V_{OUT} > 1.5\text{ V}$ , $I_{OUT} = 1\text{ mA}$ $-40\text{ °C} < T_J < 125\text{ °C}$	-3.0		3.0	
		$V_{OUT} \leq 1.5\text{ V}$ , $I_{OUT} = 1\text{ mA}$		$\pm 10$		mV
		$V_{OUT} \leq 1.5\text{ V}$ , $I_{OUT} = 1\text{ mA}$ $-40\text{ °C} < T_J < 125\text{ °C}$		$\pm 30$		
$\Delta V_{OUT}$	Static line regulation	$V_{OUT} + 1\text{ V} \leq V_{IN} \leq 5.5\text{ V}$ $I_{OUT} = 1\text{ mA}$		0.01		%/V
$\Delta V_{OUT}$	Transient line regulation (2)	$\Delta V_{IN} = +500\text{ mV}$ , $I_{OUT} = 1\text{ mA}$ $T_R = T_F = 5\text{ }\mu\text{s}$		10		mVpp
$\Delta V_{OUT}$	Static load regulation	$I_{OUT} = 1\text{ mA}$ to 150 mA		0.002		%/mA
$\Delta V_{OUT}$	Transient load regulation (2)	$I_{OUT} = 1\text{ mA}$ to 150 mA $T_R = T_F = 5\text{ }\mu\text{s}$		40		mVpp
$V_{DROP}$	Dropout voltage (3)	$I_{OUT} = 100\text{ mA}$ , $V_{OUT} > 1.5\text{ V}$ $-40\text{ °C} < T_J < 125\text{ °C}$		80	100	mV
$e_N$	Output noise voltage	1.1 kHz to 100 kHz, $I_{OUT} = 10\text{ mA}$ $V_{OUT} = 0.8\text{ V}$		29		$\mu\text{V}_{RMS}$
SVR	Supply voltage rejection $V_{OUT} = 1.5\text{ V}$	$V_{IN} = V_{OUTNOM} + 0.5\text{ V} \pm V_{RIPPLE}$ $V_{RIPPLE} = 0.1\text{ V}$ , freq. = 1 kHz $I_{OUT} = 10\text{ mA}$		65		dB
		$V_{IN} = V_{OUTNOM} + 0.5\text{ V} \pm V_{RIPPLE}$ $V_{RIPPLE} = 0.1\text{ V}$ , freq.=10 kHz $I_{OUT} = 10\text{ mA}$		62		
$I_Q$	Quiescent current	$I_{OUT} = 0\text{ mA}$		18		$\mu\text{A}$
		$I_{OUT} = 0\text{ mA}$ , $-40\text{ °C} < T_J < 125\text{ °C}$			50	
		$I_{OUT} = 0$ to 150 mA		38		
		$I_{OUT} = 0$ to 150 mA $-40\text{ °C} < T_J < 125\text{ °C}$			70	
		$V_{IN}$ input current in OFF mode: $V_{EN} = \text{GND}$		0.001	1	

Table 5. Electrical characteristics (continued)<sup>(1)</sup>

Symbol	Parameter	Test conditions	Min.	Typ.	Max.	Unit
$I_{SC}$	Short-circuit current	$R_L = 0$		350		mA
$V_{EN}$	Enable input logic low	$V_{IN} = 1.5 \text{ V to } 5.5 \text{ V}$ $-40 \text{ }^\circ\text{C} < T_J < 125 \text{ }^\circ\text{C}$			0.4	V
	Enable input logic high	$V_{IN} = 1.5 \text{ V to } 5.5 \text{ V}$ $-40 \text{ }^\circ\text{C} < T_J < 125 \text{ }^\circ\text{C}$	0.9			V
$I_{EN}$	Enable pin input current	$V_{EN} = V_{IN}$		0.1	100	nA
$T_{ON}$	Turn-on time <sup>(4)</sup>			30		$\mu\text{s}$
$T_{SHDN}$	Thermal shutdown			160		$^\circ\text{C}$
	Hysteresis			20		
$C_{OUT}$	Output capacitor	Capacitance (see typical performance characteristics for stability)	1		22	$\mu\text{F}$

1. For  $V_{OUT(NOM)} < 1.2 \text{ V}$ ,  $V_{IN} = 1.5 \text{ V}$
2. All transient values are guaranteed by design, not production tested
3. Dropout voltage is the input-to-output voltage difference at which the output voltage is 100 mV below its nominal value. This specification does not apply to output voltages below 1.5 V
4. Turn-on time is the time measured between the enable input just exceeding  $V_{EN}$  high value and the output voltage just reaching 95% of its nominal value

## 6 Typical performance characteristics

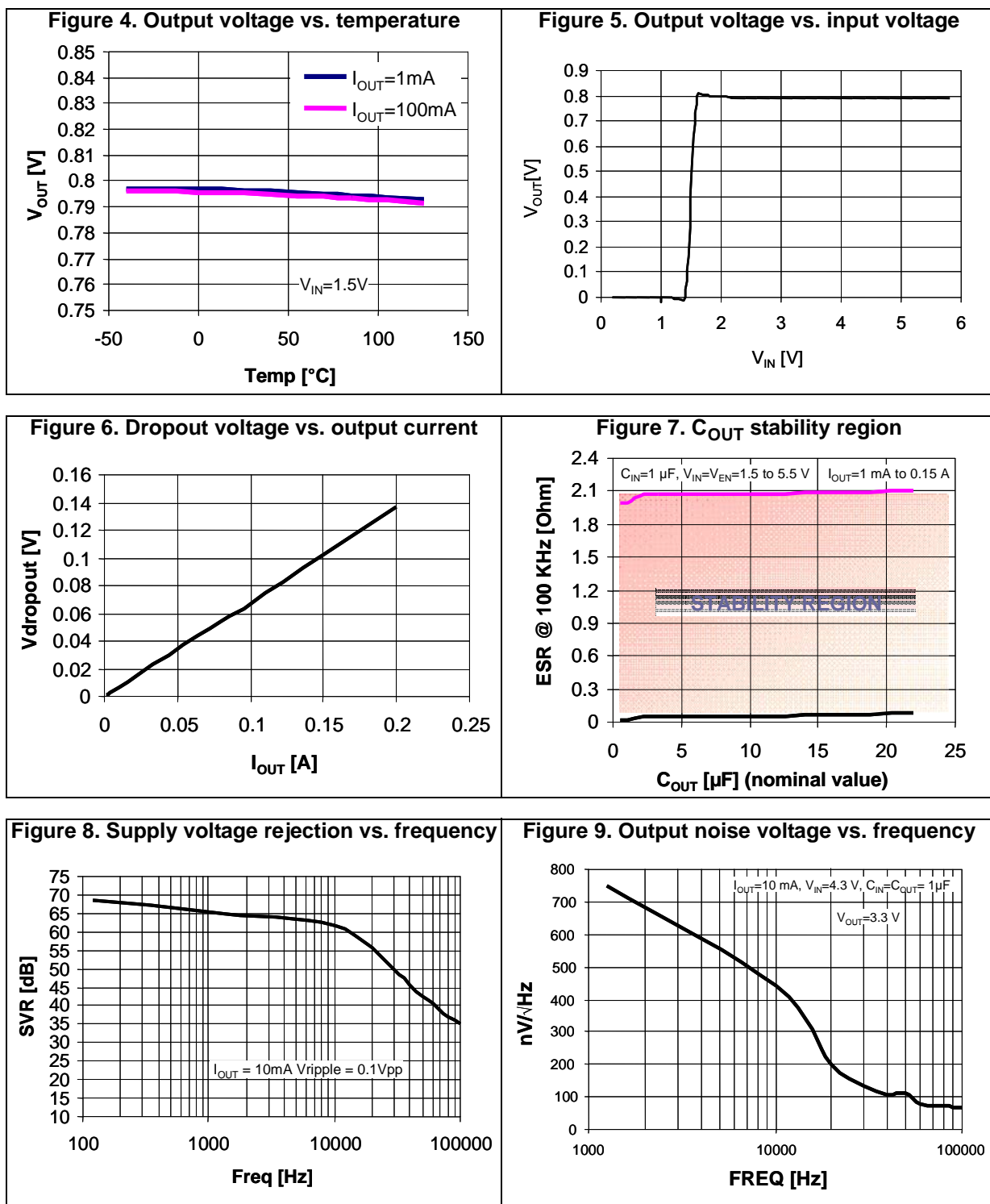

Figure 10. Quiescent current vs. input voltage

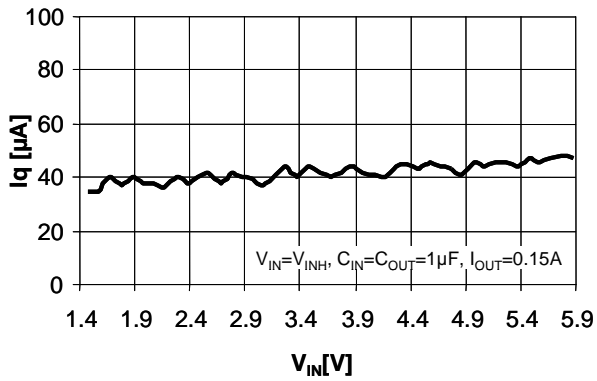
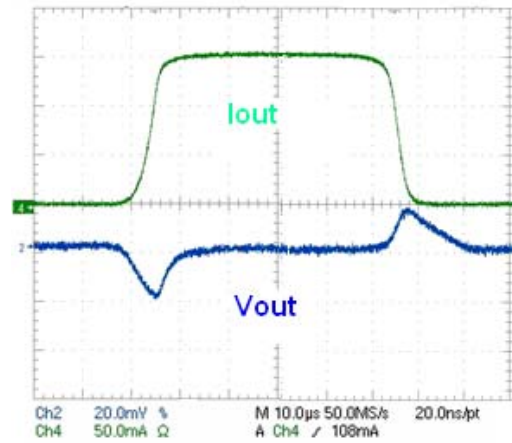
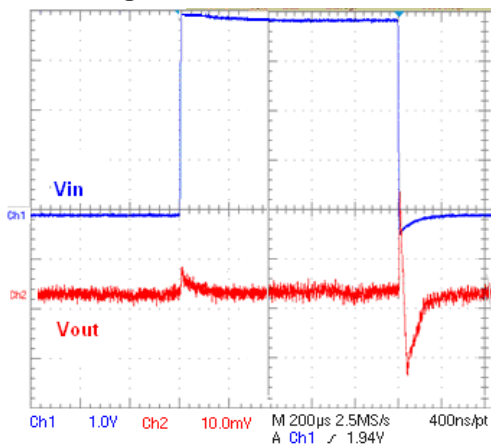

Figure 11. Load transient



$V_{EN} = V_{IN} = 1.5V, I_{OUT} = 1mA \text{ to } 0.15A, C_{IN} = C_{OUT} = 1\mu F, t_r = t_f = 5\mu s$

Figure 12. Line transient



$V_{IN} = V_{EN} = 1.5 \text{ to } 5.5V, I_{OUT} = 1mA, C_{OUT} = 1\mu F, t_r = t_f = 5\mu s$

Figure 13. Enable transient

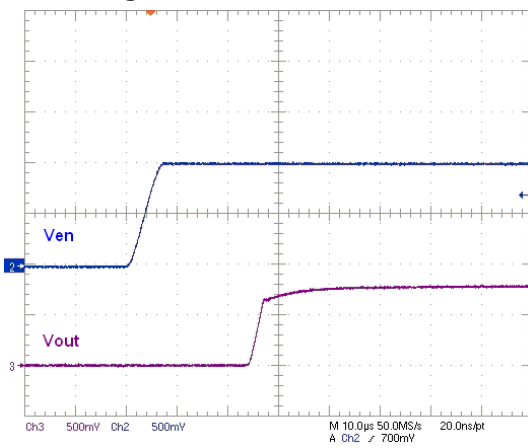

$V_{IN} = 1.5V, V_{EN} = 0 \text{ to } 1V, I_{OUT} = 1mA, C_{IN} = C_{OUT} = 1\mu F$

## 7 Package information

In order to meet environmental requirements, ST offers these devices in different grades of ECOPACK<sup>®</sup> packages, depending on their level of environmental compliance. ECOPACK<sup>®</sup> specifications, grade definitions and product status are available at: [www.st.com](http://www.st.com). ECOPACK is an ST trademark.

### 7.1 SOT23-5L package information

Figure 14. SOT23-5L package outline

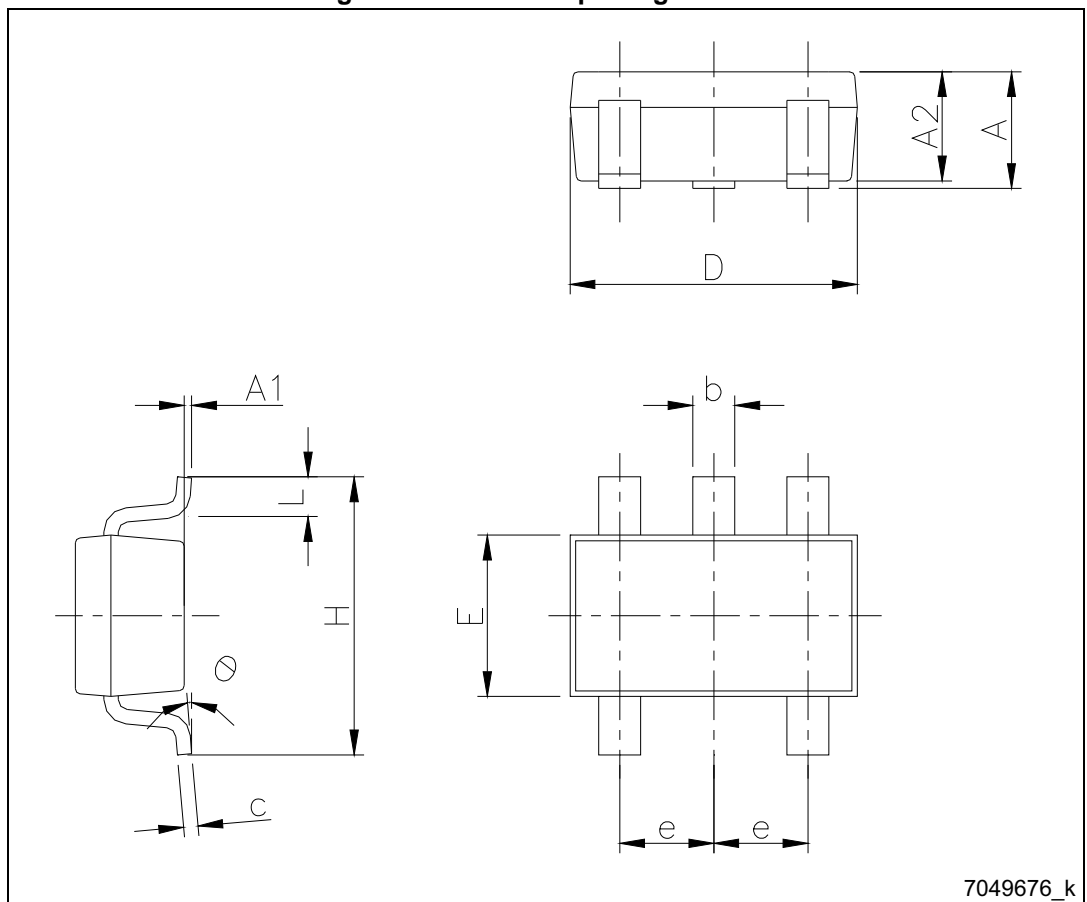
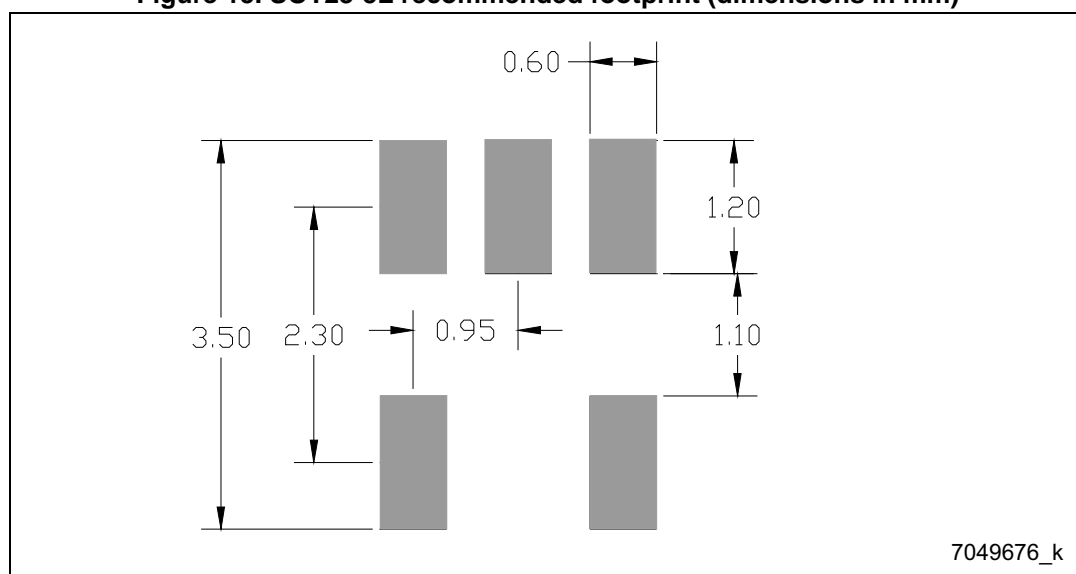

Table 6. SOT23-5L mechanical data

Dim.	mm		
	Min.	Typ.	Max.
A	0.90		1.45
A1	0		0.15
A2	0.90		1.30
b	0.30		0.50
c	0.09		0.20
D		2.95	
E		1.60	
e		0.95	
H		2.80	
L	0.30		0.60
q	0		8

Figure 15. SOT23-5L recommended footprint (dimensions in mm)



## 7.2 SOT23-5L packing information

Figure 16. SOT23-5L tape and reel outline

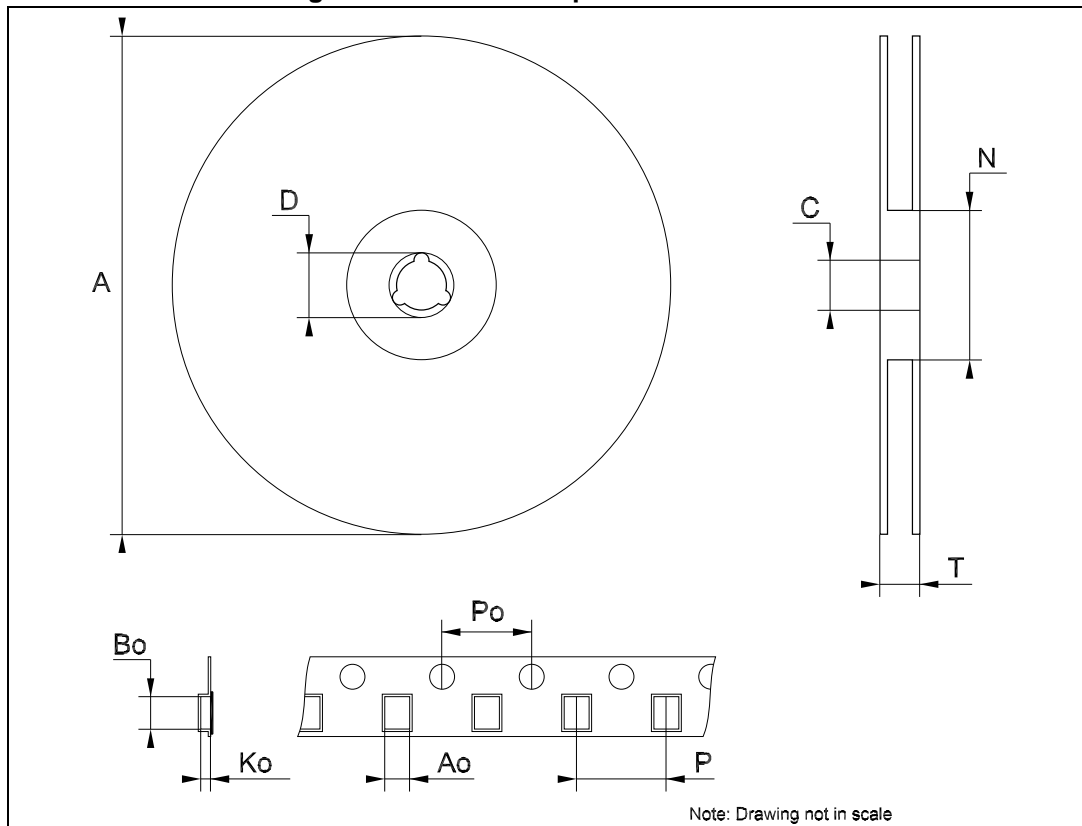

Table 7. SOT23-5L tape and reel mechanical data

Dim.	mm		
	Min.	Typ.	Max.
A			180
C	12.8	13.0	13.2
D	20.2		
N	60		
T			14.4
Ao	3.13	3.23	3.33
Bo	3.07	3.17	3.27
Ko	1.27	1.37	1.47
Po	3.9	4.0	4.1
P	3.9	4.0	4.1

## 8 Revision history

**Table 8. Document revision history**

Date	Revision	Changes
13-Nov-2007	1	Initial release.
11-Apr-2008	2	Modified: <a href="#">Table 5 on page 7</a> .
12-Feb-2009	3	Modified: <a href="#">Table 1 on page 1</a> .
11-Feb-2014	4	Part number LD39015xx changed to LD39015. Updated the <a href="#">Description</a> in cover page and <a href="#">Section 7: Package information</a> . Added <a href="#">Section 7.2: SOT23-5L packing information</a> . Minor text changes.
07-Jul-2015	5	Removed SOT666 package. Updated features in cover page, <a href="#">Table 1: Device summary</a> , <a href="#">Table 2: Pin description</a> , <a href="#">Table 4: Thermal data</a> , <a href="#">Figure 2: Pin connection (top view)</a> and <a href="#">Section 7: Package information</a> . Minor text changes.

**IMPORTANT NOTICE – PLEASE READ CAREFULLY**

STMicroelectronics NV and its subsidiaries ("ST") reserve the right to make changes, corrections, enhancements, modifications, and improvements to ST products and/or to this document at any time without notice. Purchasers should obtain the latest relevant information on ST products before placing orders. ST products are sold pursuant to ST's terms and conditions of sale in place at the time of order acknowledgement.

Purchasers are solely responsible for the choice, selection, and use of ST products and ST assumes no liability for application assistance or the design of Purchasers' products.

No license, express or implied, to any intellectual property right is granted by ST herein.

Resale of ST products with provisions different from the information set forth herein shall void any warranty granted by ST for such product.

ST and the ST logo are trademarks of ST. All other product or service names are the property of their respective owners.



Information in this document supersedes and replaces information previously supplied in any prior versions of this document.

© 2015 STMicroelectronics – All rights reserved



## Looking for pricing, stock, or lifecycle information?

Click below to explore more details on WIN SOURCE:

-  [View LD39015M18R on WIN SOURCE](#)
-  [STMicroelectronics Information](#)

## Optimize Your Supply Chain with WIN SOURCE Solutions

-  Global Sourcing Solution
-  Obsolete Management
-  Cost Control Management
-  Shortage Management
-  Alternative Solution
-  Excess Inventory Management