



**THE DATASHEET OF
LD6836TD/28P,125**



LD6836 series

Ultra low dropout regulators, low noise, 300 mA

Rev. 2 — 5 October 2012

Product data sheet

1. Product profile

1.1 General description

The LD6836 series is a small-size Low DropOut regulator (LDO) family with a typical voltage drop of 90 mV at 300 mA current rating. Operating input voltages can range from 2.3 V to 5.5 V. The devices are available with fixed output voltages between 1.2 V and 3.6 V.

In disabled mode the LD6836x/xxH devices show a high-ohmic state at the output pin while the LD6836x/xxP devices contain a pull-down switching transistor to provide a low-ohmic output state (auto discharge function).

The LD6836CX4 and LD6836CX4/C devices are in a 0.4 mm pitch Wafer-Level Chip-Scale Package (WLCSP) making them ideal for use in portable applications requiring component miniaturization. The LD6836TD devices are in a small SOT753 Surface-Mounted Device (SMD) plastic package. All devices are manufactured in monolithic silicon technology.

1.2 Features and benefits

- 300 mA output current rating
- Input voltage range 2.3 V to 5.5 V
- Fixed output voltage between 1.2 V and 3.6 V
- Dropout voltage 90 mV at 300 mA output rating
- Low quiescent current in shutdown mode (typical 0.1 μ A)
- 30 μ V RMS output noise voltage (typical value) at 10 Hz to 100 kHz
- Turn-on time 150 μ s
- 55 dB Power Supply Rejection Ratio (PSRR) at 1 kHz
- Over-temperature protection
- Output current limiter
- LD6836x/xxH: high-ohmic (3-state) output state when disabled
- LD6836x/xxP: low-ohmic output state when disabled (auto discharge function)
- Integrated ElectroStatic Discharge (ESD) protection up to 10 kV Human Body Model (HBM)
- WLCSP with 0.4 mm pitch and package size of 0.76 mm \times 0.76 mm \times 0.47 mm
- Small SOT753 SMD plastic package (SOT23-5 compatible)
- Pb-free, Restriction of Hazardous Substances (RoHS) compliant and free of halogen and antimony (dark green compliant)



1.3 Applications

Analog and digital interfaces requiring lower than standard supply voltages in mobile appliances such as smartphones, mobile phone handsets and cordless telephones. Other typical applications are digital still cameras, mobile internet devices, personal navigation devices and portable media players.

2. Pinning information

2.1 Pinning

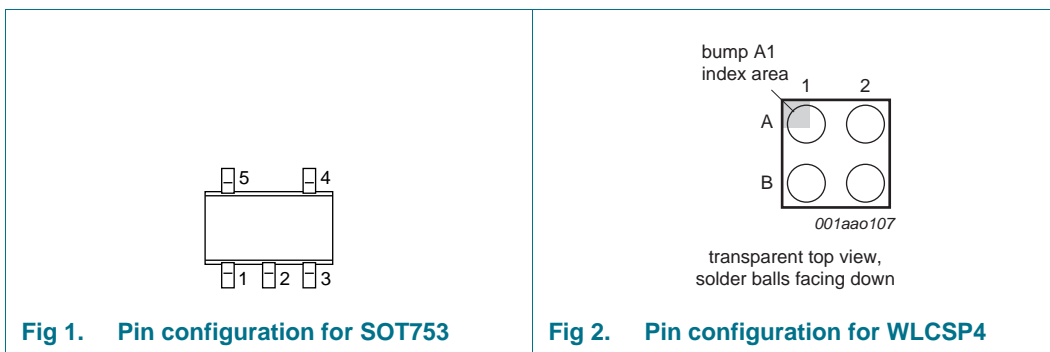

2.2 Pin description

Table 1. Pin description for SOT753

Symbol	Pin	Description
IN	1	regulator input voltage
GND	2	supply ground
EN	3	device enable input; active HIGH
n.c.	4	not connected
OUT	5	regulator output voltage

Table 2. Pin description for WLCSP4

Symbol	Pin	Description
GND	A1	supply ground
EN	A2	device enable input; active HIGH
OUT	B1	regulator output voltage
IN	B2	regulator input voltage

3. Ordering information

Table 3. Ordering information

Type number	Package		
	Name	Description	Version
LD6836CX4	WLCSP4	wafer-level chip-scale package; 4 bumps (2 × 2) [1]	-
LD6836CX4/C	WLCSP4	wafer-level chip-scale package with backside coating; 4 bumps (2 × 2) [1]	-
LD6836TD	-	plastic surface-mounted package; 5 leads	SOT753

[1] Size 0.76 mm × 0.76 mm.

3.1 Ordering options

Further information on output voltage is available on request; see [Section 18 “Contact information”](#).

Table 4. Type number extension of high-ohmic output in WLCSP4

Type number	Nominal output voltage	Type number	Nominal output voltage
LD6836CX4/12H	1.2 V	LD6836CX4/25H	2.5 V
LD6836CX4/13H	1.3 V	LD6836CX4/27H	2.7 V
LD6836CX4/14H	1.4 V	LD6836CX4/28H	2.8 V
LD6836CX4/16H	1.6 V	LD6836CX4/29H	2.9 V
LD6836CX4/18H	1.8 V	LD6836CX4/30H	3.0 V
LD6836CX4/20H	2.0 V	LD6836CX4/33H	3.3 V
LD6836CX4/22H	2.2 V	LD6836CX4/36H	3.6 V
LD6836CX4/23H	2.3 V	-	-

Table 5. Type number extension of pull-down output in WLCSP4

Type number	Nominal output voltage	Type number	Nominal output voltage
LD6836CX4/12P	1.2 V	LD6836CX4/23P	2.3 V
LD6836CX4/13P	1.3 V	LD6836CX4/25P	2.5 V
LD6836CX4/14P	1.4 V	LD6836CX4/27P	2.7 V
LD6836CX4/16P	1.6 V	LD6836CX4/28P	2.8 V
LD6836CX4/18P	1.8 V	LD6836CX4/29P	2.9 V
LD6836CX4/20P	2.0 V	LD6836CX4/30P	3.0 V
LD6836CX4/21P	2.1 V	LD6836CX4/33P	3.3 V
LD6836CX4/22P	2.2 V	LD6836CX4/36P	3.6 V

Table 6. Type number extension of pull-down output in WLCSP4 with backside coating

Type number	Nominal output voltage	Type number	Nominal output voltage
LD6836CX4/C12P	1.2 V	LD6836CX4/C23P	2.3 V
LD6836CX4/C13P	1.3 V	LD6836CX4/C25P	2.5 V
LD6836CX4/C14P	1.4 V	LD6836CX4/C27P	2.7 V
LD6836CX4/C16P	1.6 V	LD6836CX4/C28P	2.8 V
LD6836CX4/C18P	1.8 V	LD6836CX4/C29P	2.9 V
LD6836CX4/C20P	2.0 V	LD6836CX4/C30P	3.0 V
LD6836CX4/C21P	2.1 V	LD6836CX4/C33P	3.3 V
LD6836CX4/C22P	2.2 V	LD6836CX4/C36P	3.6 V

Table 7. Type number extension of high-ohmic output in SOT753

Type number	Nominal output voltage	Type number	Nominal output voltage
LD6836TD/12H	1.2 V	LD6836TD/23H	2.3 V
LD6836TD/13H	1.3 V	LD6836TD/27H	2.7 V
LD6836TD/14H	1.4 V	LD6836TD/28H	2.8 V
LD6836TD/16H	1.6 V	LD6836TD/29H	2.9 V
LD6836TD/18H	1.8 V	LD6836TD/30H	3.0 V
LD6836TD/20H	2.0 V	LD6836TD/33H	3.3 V
LD6836TD/22H	2.2 V	LD6836TD/36H	3.6 V

Table 8. Type number extension of pull-down output in SOT753

Type number	Nominal output voltage	Type number	Nominal output voltage
LD6836TD/12P	1.2 V	LD6836TD/23P	2.3 V
LD6836TD/13P	1.3 V	LD6836TD/25P	2.5 V
LD6836TD/14P	1.4 V	LD6836TD/27P	2.7 V
LD6836TD/16P	1.6 V	LD6836TD/28P	2.8 V
LD6836TD/18P	1.8 V	LD6836TD/29P	2.9 V
LD6836TD/20P	2.0 V	LD6836TD/30P	3.0 V
LD6836TD/21P	2.1 V	LD6836TD/33P	3.3 V
LD6836TD/22P	2.2 V	LD6836TD/36P	3.6 V

4. Block diagram

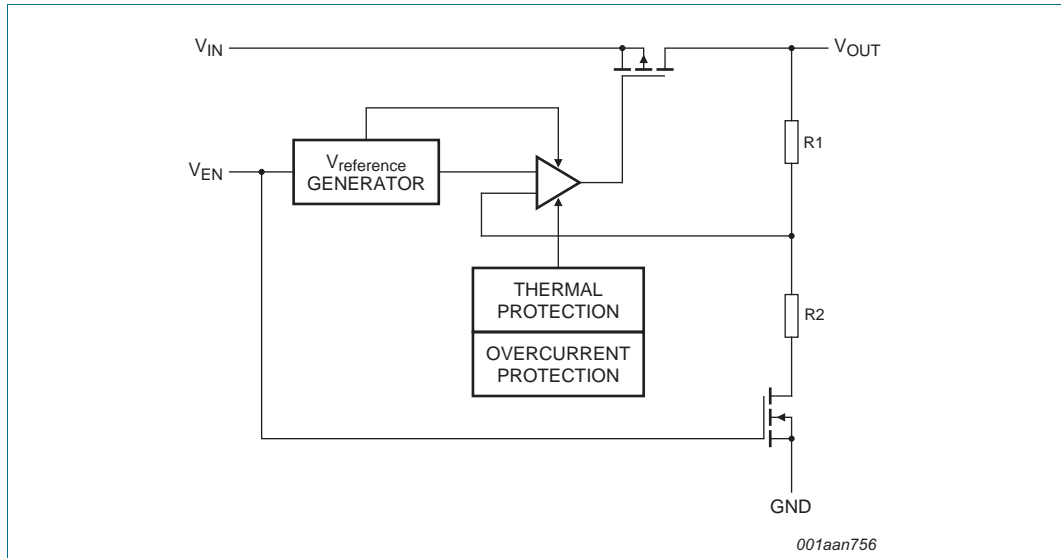

Fig 3. Block diagram of LD6836/xxH

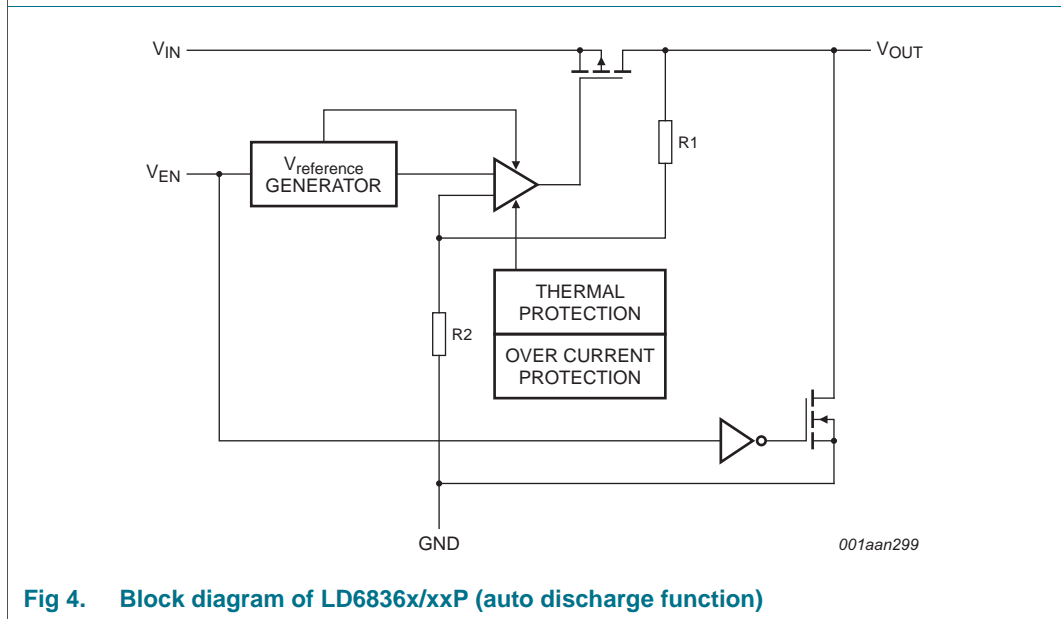

Fig 4. Block diagram of LD6836/xxP (auto discharge function)

5. Limiting values

Table 9. Limiting values

In accordance with the Absolute Maximum Rating System (IEC 60134). Voltages are referenced to GND (ground = 0 V).

Symbol	Parameter	Conditions	Min	Max	Unit
V _{IN}	voltage on pin IN	4 ms transient	-0.5	+6.0	V
P _{tot}	total power dissipation	LD6836CX4, LD6836CX4/C	[1] -	770	mW
		LD6836TD	[1] -	800	mW
T _{stg}	storage temperature		-55	+150	°C
T _j	junction temperature		-40	+125	°C
T _{amb}	ambient temperature		-40	+85	°C
V _{ESD}	electrostatic discharge voltage	human body model level 6	[2] -	±10	kV
		machine model class 3	[3] -	±400	V

- [1] The (absolute) maximum power dissipation depends on the junction temperature T_j. Higher power dissipation is allowed with lower ambient temperatures. The conditions to determine the specified values are T_{amb} = 25 °C and the use of a two layer Printed-Circuit Board (PCB).
- [2] According to IEC 61340-3-1.
- [3] According to JESD22-A115C.

6. Recommended operating conditions

Table 10. Operating conditions

Voltages are referenced to GND (ground = 0 V).

Symbol	Parameter	Conditions	Min	Typ	Max	Unit
T _{amb}	ambient temperature		-40	-	+85	°C
T _j	junction temperature		-	-	+125	°C
Pin IN						
V _{IN}	voltage on pin IN		2.3	-	5.5	V
Pin EN						
V _{EN}	voltage on pin EN		0	-	V _{IN}	V
Pin OUT						
C _{L(ext)}	external load capacitance		[1] 0.7	1.0	-	μF

- [1] See [Section 10.1 "Capacitor values"](#).

7. Thermal characteristics

Table 11. Thermal characteristics

Symbol	Parameter	Conditions	Typ	Unit
$R_{th(j-a)}$	thermal resistance from junction to ambient	LD6836CX4, LD6836CX4/C	[1][2] 130	K/W
		LD6836TD	[1][2] 125	K/W

- [1] The overall $R_{th(j-a)}$ can vary depending on the board layout. To minimize the effective $R_{th(j-a)}$, all pins must have a solid connection to larger Cu layer areas for example to the power and ground layer. In multi-layer PCB applications, the second layer is used to create a large heat spreader area directly below the LDO. If this layer is either ground or power, it is connected with several vias to the top layer connecting to the device ground or supply. Avoid the use of solder-stop varnish under the chip.
- [2] Use the measurement data given for a rough estimation of the $R_{th(j-a)}$ in your application. The actual $R_{th(j-a)}$ value can vary in applications using different layer stacks and layouts.

8. Characteristics

Table 12. Electrical characteristics

At recommended input voltages and $T_{amb} = -40\text{ °C}$ to $+85\text{ °C}$; voltages are referenced to GND (ground = 0 V); unless otherwise specified.

Symbol	Parameter	Conditions	Min	Typ	Max	Unit	
Output voltage							
V_{do}	dropout voltage	$I_{OUT} = 300\text{ mA}$; $V_{IN} < V_{O(nom)}$	[1]				
		LD6836CX4, LD6836CX4/C	-	90	160	mV	
		LD6836TD	-	100	200	mV	
ΔV_O	output voltage variation	$V_{OUT} < 1.8\text{ V}$; $I_{OUT} = 1\text{ mA}$					
		$T_{amb} = +25\text{ °C}$	-3	± 0.5	+3	%	
		$-30\text{ °C} \leq T_{amb} \leq +85\text{ °C}$	-4	-	+4	%	
		$V_{OUT} \geq 1.8\text{ V}$; $I_{OUT} = 1\text{ mA}$					
		$T_{amb} = +25\text{ °C}$	-2	± 0.5	+2	%	
		$-30\text{ °C} \leq T_{amb} \leq +85\text{ °C}$	-3	-	+3	%	
Line regulation error							
$\Delta V_O / (V_O \times \Delta V_I)$	relative output voltage variation with input voltage	$V_{IN} = (V_{O(nom)} + 0.2\text{ V})$ to 5.5 V	[1]	-0.1	-	+0.1 %/V	
Load regulation error							
$\Delta V_O / (V_O \times \Delta I_O)$	relative output voltage variation with output current	$1\text{ mA} \leq I_{OUT} \leq 300\text{ mA}$	-	0.0025	0.01	%/mA	
Output current							
I_{OUT}	current on pin OUT		-	-	300	mA	
I_{OM}	peak output current	$V_{IN} = (V_{O(nom)} + 0.2\text{ V})$ to 5.5 V	[1]				
		$V_{O(nom)} > 1.8\text{ V}$; $V_{OUT} = 0.95 \times V_{O(nom)}$		350	-	-	mA
		$V_{O(nom)} < 1.8\text{ V}$; $V_{OUT} = 0.9 \times V_{O(nom)}$		350	-	-	mA
I_{sc}	short-circuit current	pin OUT	-	600	-	mA	

Table 12. Electrical characteristics ...continued

At recommended input voltages and $T_{amb} = -40\text{ }^{\circ}\text{C}$ to $+85\text{ }^{\circ}\text{C}$; voltages are referenced to GND (ground = 0 V); unless otherwise specified.

Symbol	Parameter	Conditions	Min	Typ	Max	Unit
Regulator quiescent current						
I_q	quiescent current	$V_{EN} = 1.4\text{ V}; I_{OUT} = 0\text{ mA}$	-	70	100	μA
		$V_{EN} = 1.4\text{ V}; 1\text{ mA} \leq I_{OUT} \leq 300\text{ mA}$	-	155	250	μA
		$V_{EN} \leq 0.4\text{ V}$	-	0.1	1	μA
Ripple rejection and output noise						
PSRR	power supply rejection ratio	$V_{IN} = V_{O(nom)} + 1.0\text{ V}; I_{OUT} = 30\text{ mA};$ $f_{ripple} = 1\text{ kHz}$	[1]	-55	-	dB
$V_{n(o)(RMS)}$	RMS output noise voltage	$f_{ripple} = 10\text{ Hz to }100\text{ kHz};$ $C_{L(ext)} = 1\text{ }\mu\text{F}$	-	30	-	μV
Enable input and timing						
V_{IL}	LOW-level input voltage	pin EN	0	-	0.4	V
V_{IH}	HIGH-level input voltage	pin EN	1.1	-	5.5	V
$t_{startup(reg)}$	regulator start-up time	$V_{IN} = 5.5\text{ V}; V_{OUT} = 0.95 \times V_{O(nom)};$ $I_{OUT} = 300\text{ mA}; C_{L(ext)} = 1\text{ }\mu\text{F}$	[1]	-	150	μs
LD6836x/xxP; auto discharge function						
$t_{sd(reg)}$	regulator shutdown time	$V_{IN} = 5.5\text{ V}; V_{OUT} = 0.05 \times V_{O(nom)};$ $C_{L(ext)} = 1\text{ }\mu\text{F}$	-	300	-	μs
R_{pd}	pull-down resistance		-	100	-	Ω
Over-temperature protection						
T_{sd}	shutdown temperature		-	160	-	$^{\circ}\text{C}$
$T_{sd(hys)}$	shutdown temperature hysteresis		-	20	-	$^{\circ}\text{K}$

[1] $V_{O(nom)}$ = nominal output voltage (device specific).

9. Dynamic behavior

9.1 Power Supply Rejection Ratio (PSRR)

PSRR stands for the capability of the regulator to suppress unwanted signals on the input voltage like noise or ripples.

$$PSRR[dB] = 20 \log \frac{V_{out(ripple)}}{V_{in(ripple)}} \text{ for all frequencies}$$

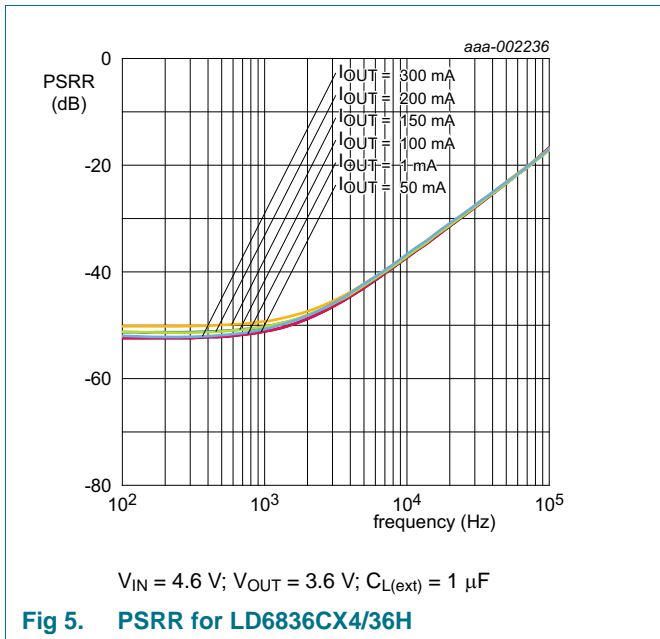

Fig 5. PSRR for LD6836CX4/36H

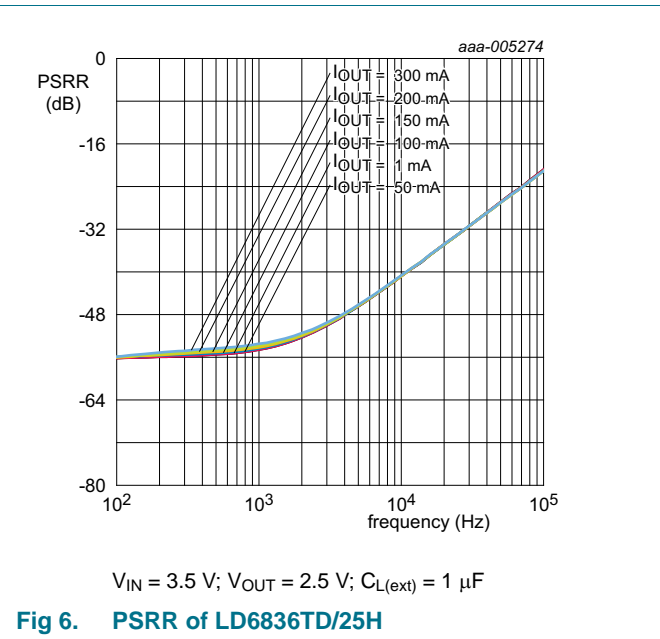

Fig 6. PSRR of LD6836TD/25H

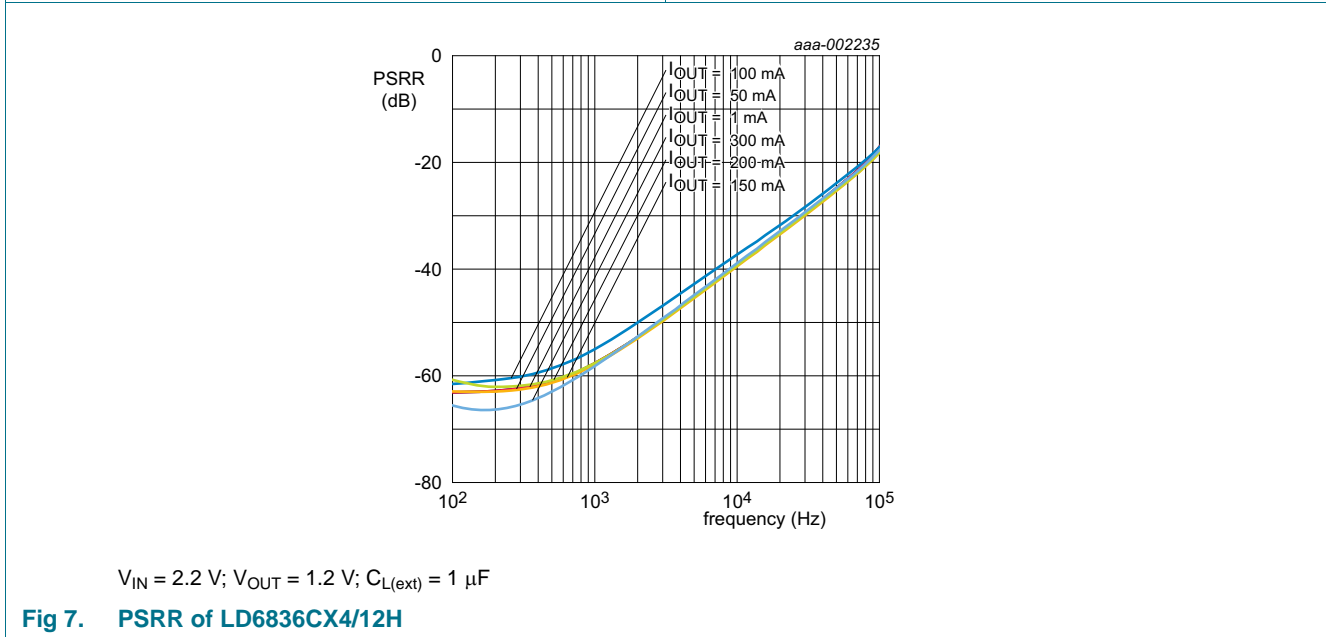

Fig 7. PSRR of LD6836CX4/12H

9.2 Dropout

The dropout voltage is defined as the smallest input to output voltage difference at a specified load current when the regulator operates within its linear region. This means that the input voltage is below the nominal output voltage value and the pass transistor works as a plain resistor.

A small dropout voltage guarantees lower power consumption and efficiency maximization.

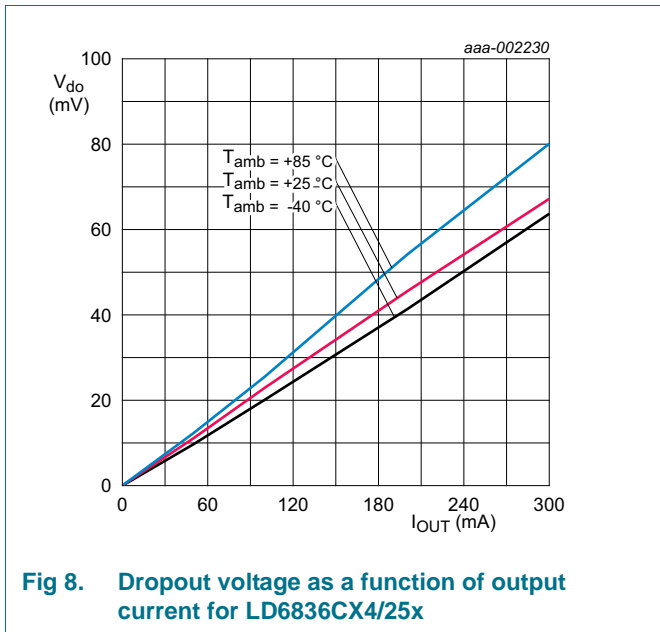

Fig 8. Dropout voltage as a function of output current for LD6836CX4/25x

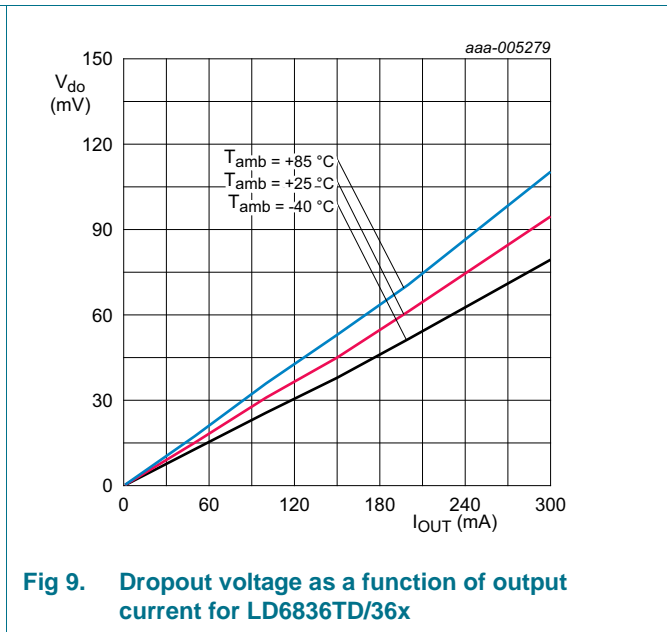

Fig 9. Dropout voltage as a function of output current for LD6836TD/36x

9.3 Accuracy

The LD6836 series guarantees high accuracy of the nominal output voltage.

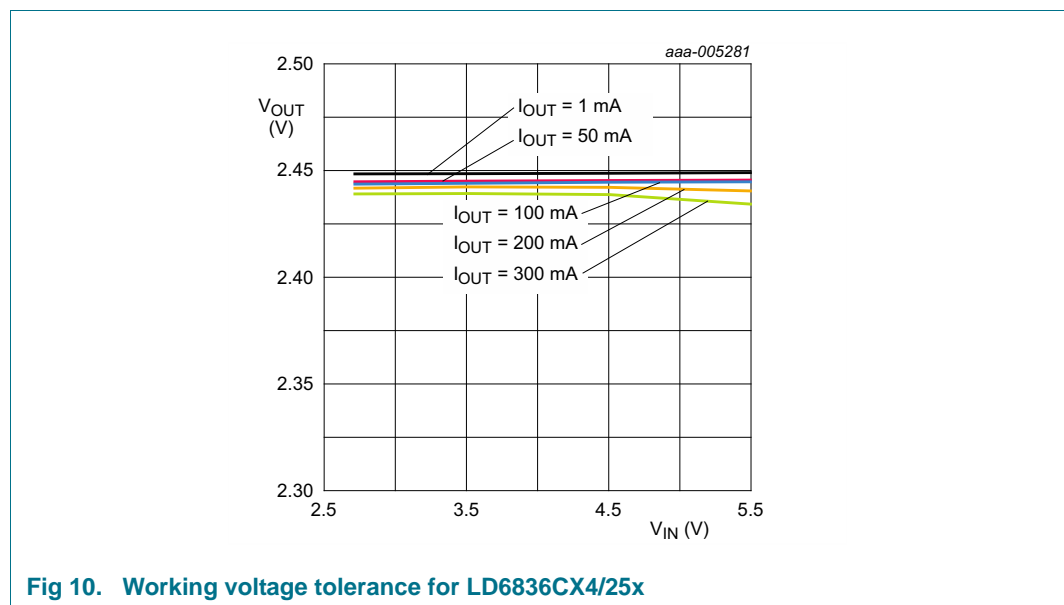
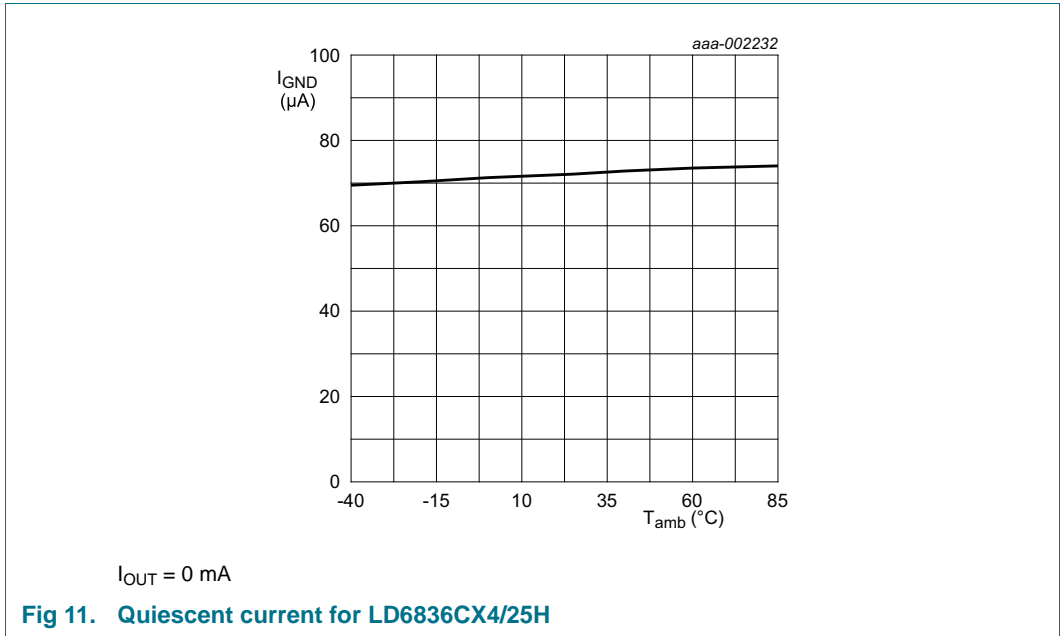

Fig 10. Working voltage tolerance for LD6836CX4/25x

9.4 Quiescent current

Quiescent (or ground) current is the difference between input and output current of the regulator.



9.5 Noise

Output noise voltage of an LDO circuit is given as noise density or RMS output noise voltage over a defined frequency spectrum (10 Hz to 100 kHz). Permanent conditions are a constant output current and a ripple-free input voltage. The output noise voltage is generated by the LDO regulator.

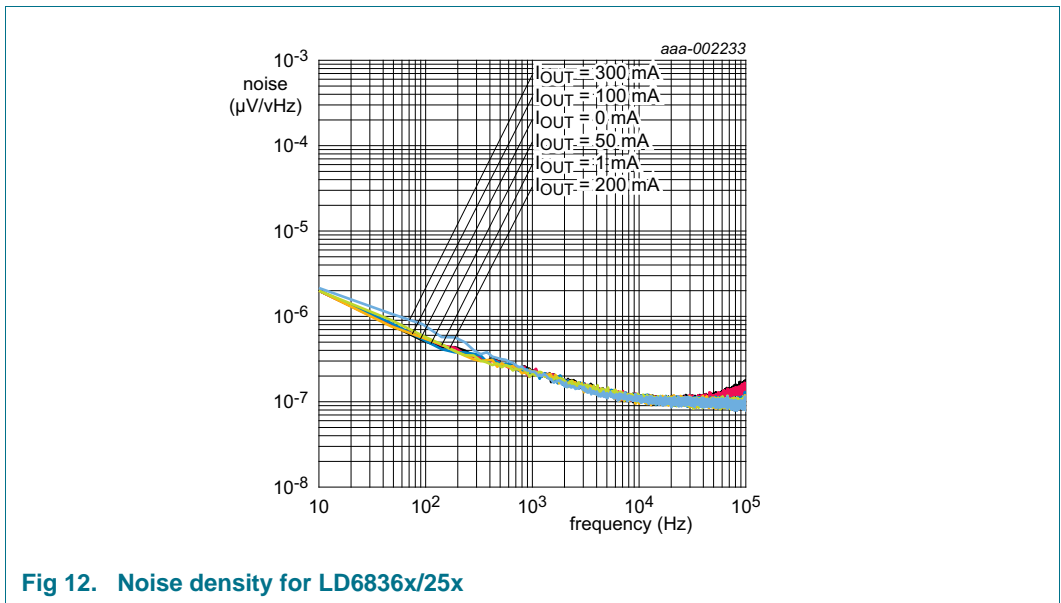

9.6 Line Regulation

Line regulation is the capability of the circuit to maintain the nominal output voltage while varying the input voltage.

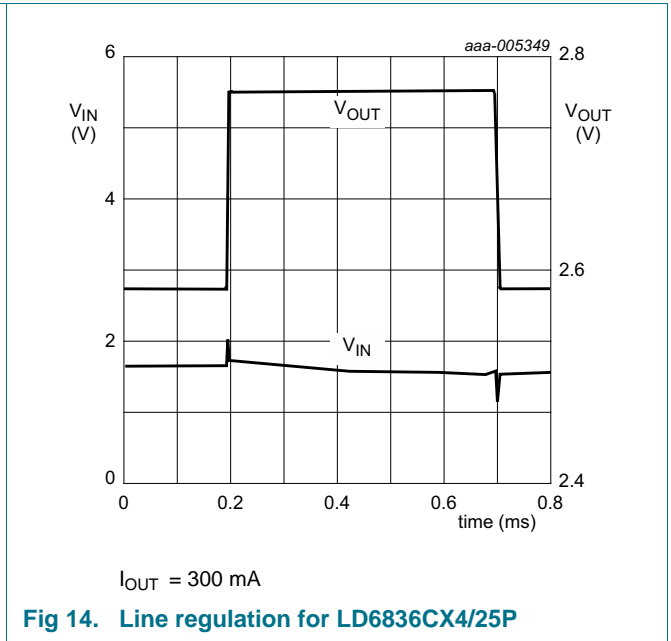
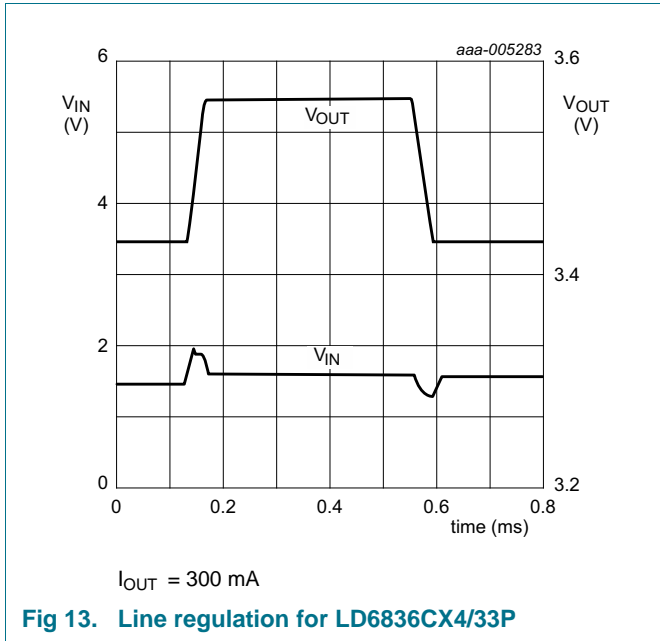

9.7 Load Regulation

Load regulation is the capability of the circuit to maintain the nominal output voltage while varying the output current.

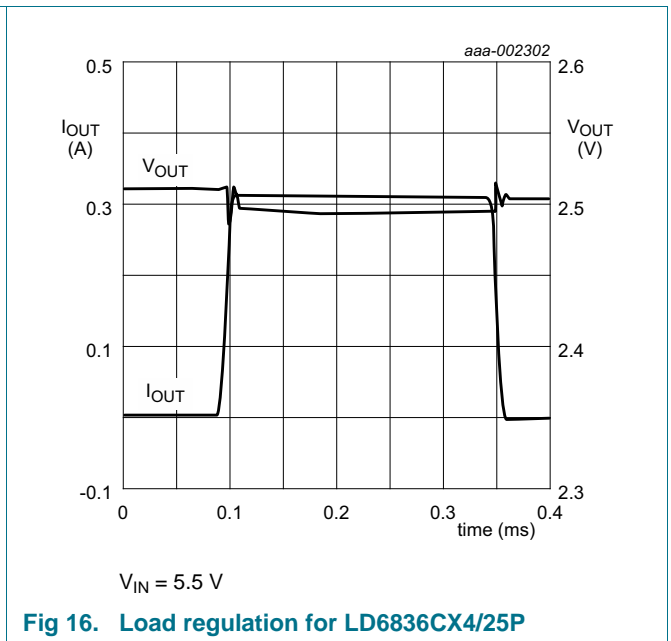
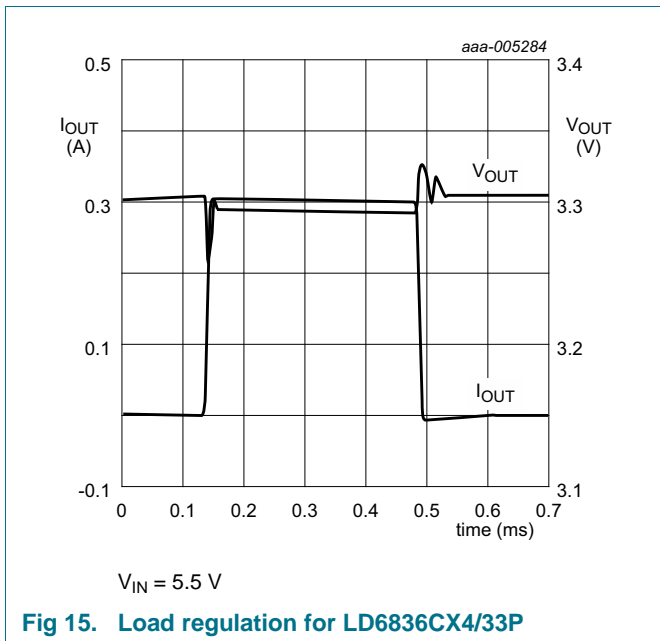

9.8 Start-up and shutdown

Start-up time defines the time needed for the LDO to achieve 95 % of its typical output voltage level after activation via the enable pin. Shutdown time defines the time needed for the LDO to pull-down the output voltage to 10 % of its nominal output voltage after deactivation via the enable pin.

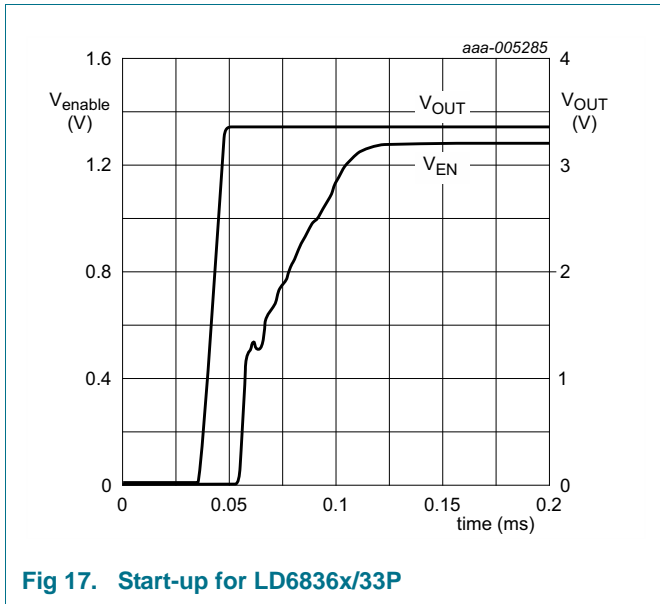

Fig 17. Start-up for LD6836x/33P

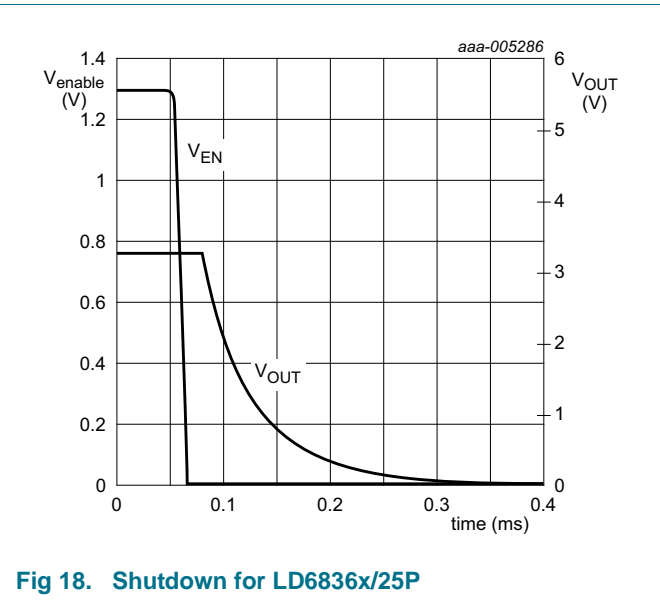

Fig 18. Shutdown for LD6836x/25P

9.9 Enable threshold voltage

An active HIGH signal enables the LDO when the signal exceeds the minimum input HIGH voltage threshold. The LDO is in Off state as long the signal is below the maximum LOW threshold. The input voltage threshold is independent from the LDO input voltage.

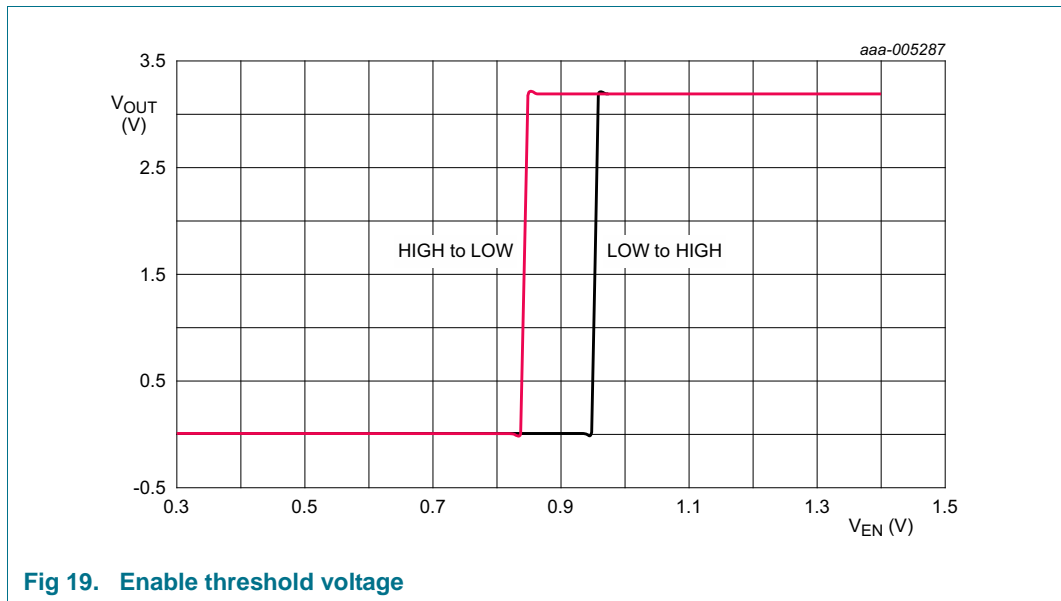

Fig 19. Enable threshold voltage

10. Application information

10.1 Capacitor values

The LD6836 series require external capacitors at the output to guarantee a stable regulator behavior. Do not under-run the specified minimum Equivalent Series Resistance (ESR). The absolute value of the total capacitance attached to the output pin OUT influences the shutdown time ($t_{sd(reg)}$) of the LD6836 series. Also an input capacitor is recommended to keep the input voltage stable.

Table 13. External load capacitor

Symbol	Parameter	Conditions	Min	Typ	Max	Unit
$C_{i(ext)}$	external input capacitance	[1]	0.7	1.0		μF
$C_{L(ext)}$	external load capacitance	[1]	0.7	1.0	-	μF
ESR	equivalent series resistance		5	-	500	$\text{m}\Omega$

[1] The minimum value of capacitance for stability and correct operation is 0.7 μF . The specified capacitor tolerance is $\pm 30\%$ or better over the temperature and operating conditions range. The recommended capacitor type is X7R to meet the full device temperature specification of $-40\text{ }^\circ\text{C}$ to $+125\text{ }^\circ\text{C}$.

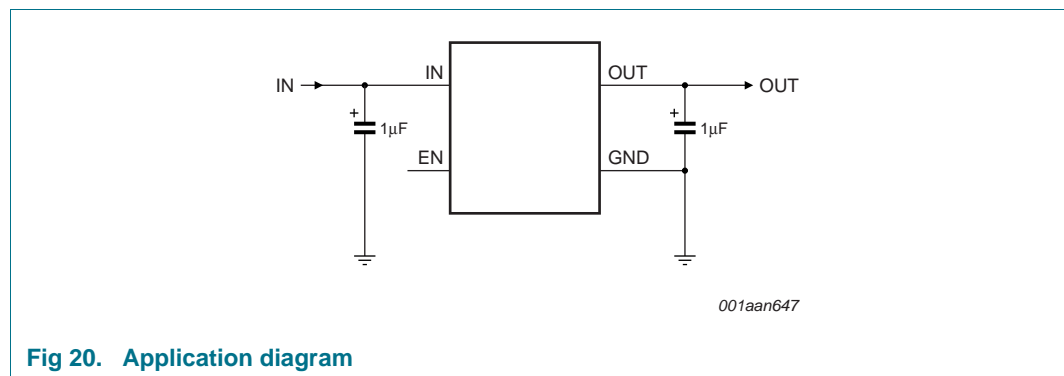

Fig 20. Application diagram

11. Test information

11.1 Quality information

This product has been qualified in accordance with *NX1-00023 NXP Semiconductors Quality and Reliability Specification* and is suitable for use in consumer applications.

12. Marking

12.1 WLCSP4

WLCSP dies are laser marked with the following information (see [Table 14](#) to [16](#) and [Figure 21](#)):

1. Shaded area: marking of pin A1
2. The character N gives the version code and describes the output mode of the LDO. If the code is legible, the LDO has an integrated pull down transistor (“P” version). If the character N is rotated counterclockwise by 90°, the LDO is a “H” version.
3. “YYY” symbolizes a placeholder for some characters of the lot ID

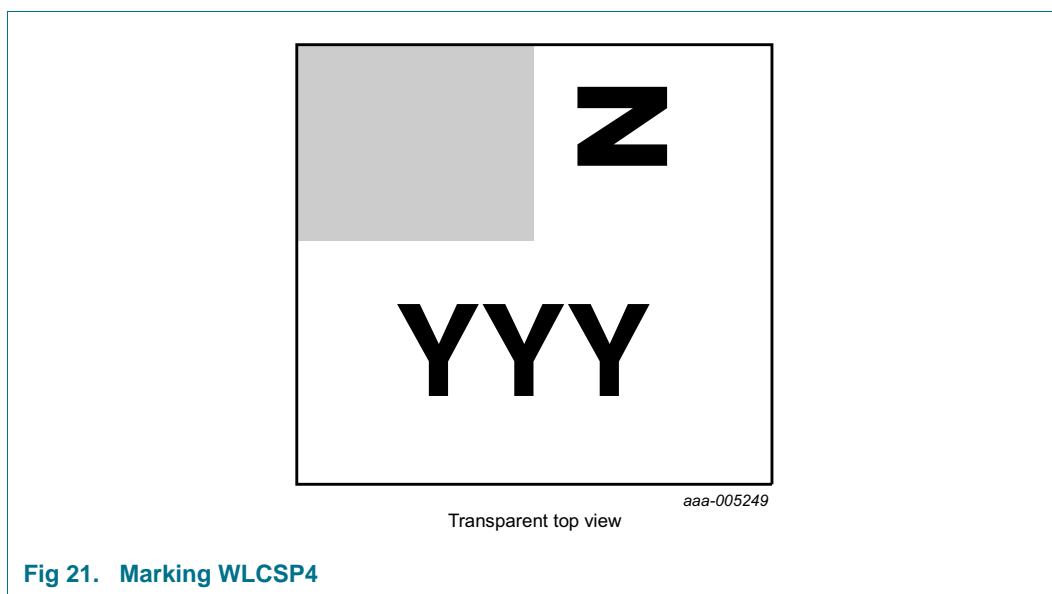

Table 14. Marking code of high-ohmic output

Type number	Nominal output voltage	Marking code
LD6836CX4/12H	1.2 V	A
LD6836CX4/27H	2.7 V	P

Table 15. Marking of pull-down output

Type number	Nominal output voltage	Marking code	Type number	Nominal output voltage	Marking code
LD6836CX4/12P	1.2 V	A	LD6836CX4/23P	2.3 V	L
LD6836CX4/13P	1.3 V	B	LD6836CX4/25P	2.5 V	N
LD6836CX4/14P	1.4 V	C	LD6836CX4/27P	2.7 V	P
LD6836CX4/16P	1.6 V	E	LD6836CX4/28P	2.8 V	Q
LD6836CX4/18P	1.8 V	G	LD6836CX4/29P	2.9 V	R
LD6836CX4/20P	2.0 V	I	LD6836CX4/30P	3.0 V	S
LD6836CX4/21P	2.1 V	J	LD6836CX4/33P	3.3 V	V
LD6836CX4/22P	2.2 V	K	LD6836CX4/36P	3.6 V	Y

Table 16. Marking code of pull-down output with backside coating

Type number	Nominal output voltage	Marking code	Type number	Nominal output voltage	Marking code
LD6836CX4/C12P	1.2 V	A	LD6836CX4/C23P	2.3 V	L
LD6836CX4/C13P	1.3 V	B	LD6836CX4/C25P	2.5 V	N
LD6836CX4/C14P	1.4 V	C	LD6836CX4/C27P	2.7 V	P
LD6836CX4/C16P	1.6 V	E	LD6836CX4/C28P	2.8 V	Q
LD6836CX4/C18P	1.8 V	G	LD6836CX4/C29P	2.9 V	R
LD6836CX4/C20P	2.0 V	I	LD6836CX4/C30P	3.0 V	S
LD6836CX4/C21P	2.1 V	J	LD6836CX4/C33P	3.3 V	V
LD6836CX4/C22P	2.2 V	K	LD6836CX4/C36P	3.6 V	Y

12.2 SOT753

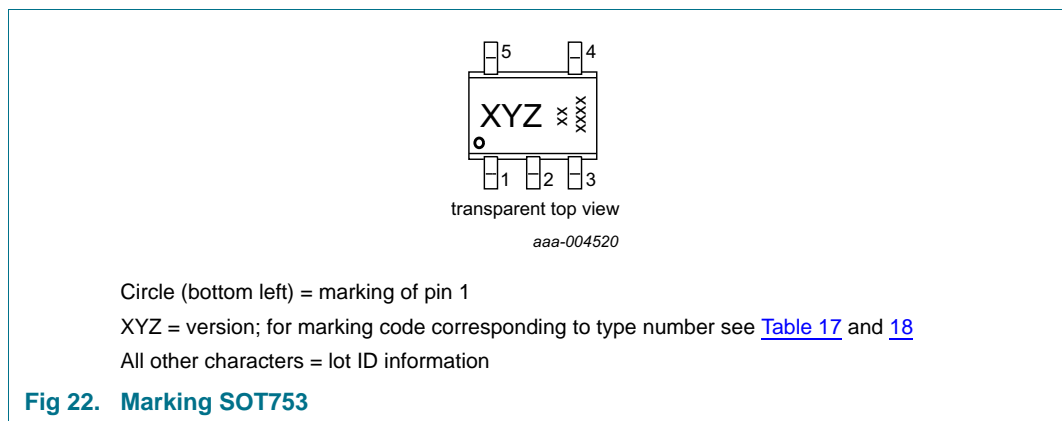

Table 17. Marking code of high-ohmic output

Type number	Nominal output voltage	Marking code	Type number	Nominal output voltage	Marking code
LD6836TD/12H	1.2 V	9AH	LD6836TD/23H	2.3 V	9LH
LD6836TD/13H	1.3 V	9BH	LD6836TD/27H	2.7 V	9PH
LD6836TD/14H	1.4 V	9CH	LD6836TD/28H	2.8 V	9QH
LD6836TD/16H	1.6 V	9EH	LD6836TD/29H	2.9 V	9RH
LD6836TD/18H	1.8 V	9GH	LD6836TD/30H	3.0 V	9SH
LD6836TD/20H	2.0 V	9JH	LD6836TD/33H	3.3 V	9VH
LD6836TD/22H	2.2 V	9KH	LD6836TD/36H	3.6 V	9YH

Table 18. Marking of pull-down output

Type number	Nominal output voltage	Marking code	Type number	Nominal output voltage	Marking code
LD6836TD/12P	1.2 V	9AP	LD6836TD/23P	2.3 V	9LP
LD6836TD/13P	1.3 V	9BP	LD6836TD/25P	2.5 V	9NP
LD6836TD/14P	1.4 V	9CP	LD6836TD/27P	2.7 V	9PP
LD6836TD/16P	1.6 V	9EP	LD6836TD/28P	2.8 V	9QP
LD6836TD/18P	1.8 V	9GP	LD6836TD/29P	2.9 V	9RP
LD6836TD/20P	2.0 V	9JP	LD6836TD/30P	3.0 V	9SP
LD6836TD/21P	2.1 V	9ZP	LD6836TD/33P	3.3 V	9VP
LD6836TD/22P	2.2 V	9KP	LD6836TD/36P	3.6 V	9YP

13. Package outline

WLCSP4: wafer level chip-size package; 4 bumps (2 x 2)

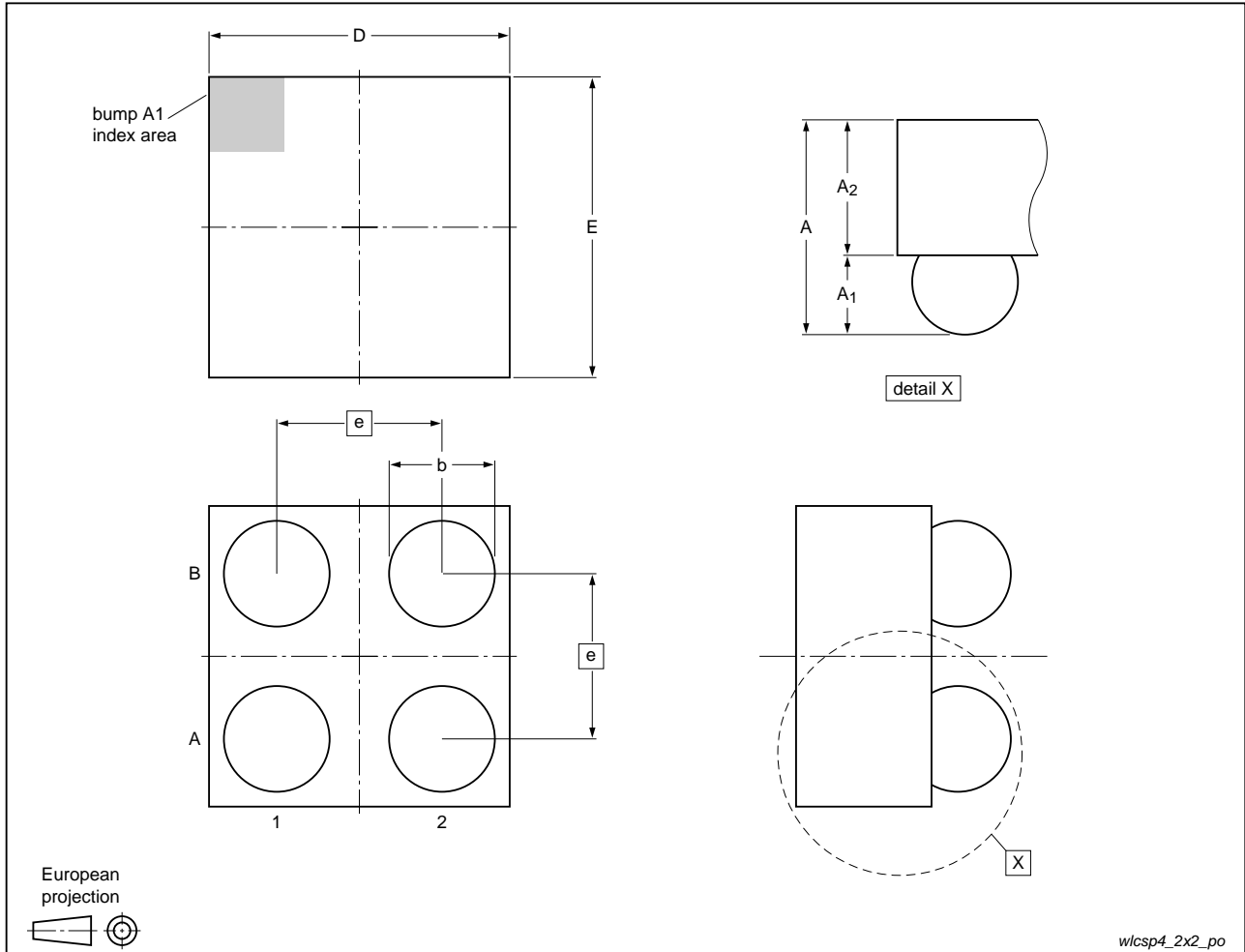

Fig 23. Package outline LD6836CX4 (WLCSP4)

Table 19. Dimensions for [Figure 23](#)

Symbol	Min	Typ	Max	Unit
A	0.44	0.47	0.50	mm
A ₁	0.18	0.20	0.22	mm
A ₂	0.26	0.27	0.28	mm
b	0.21	0.26	0.31	mm
D	0.71	0.76	0.81	mm
E	0.71	0.76	0.81	mm
e	-	0.4	-	mm

WLCSP4: wafer level chip-size package with backside coating; 4 bumps (2 x 2)

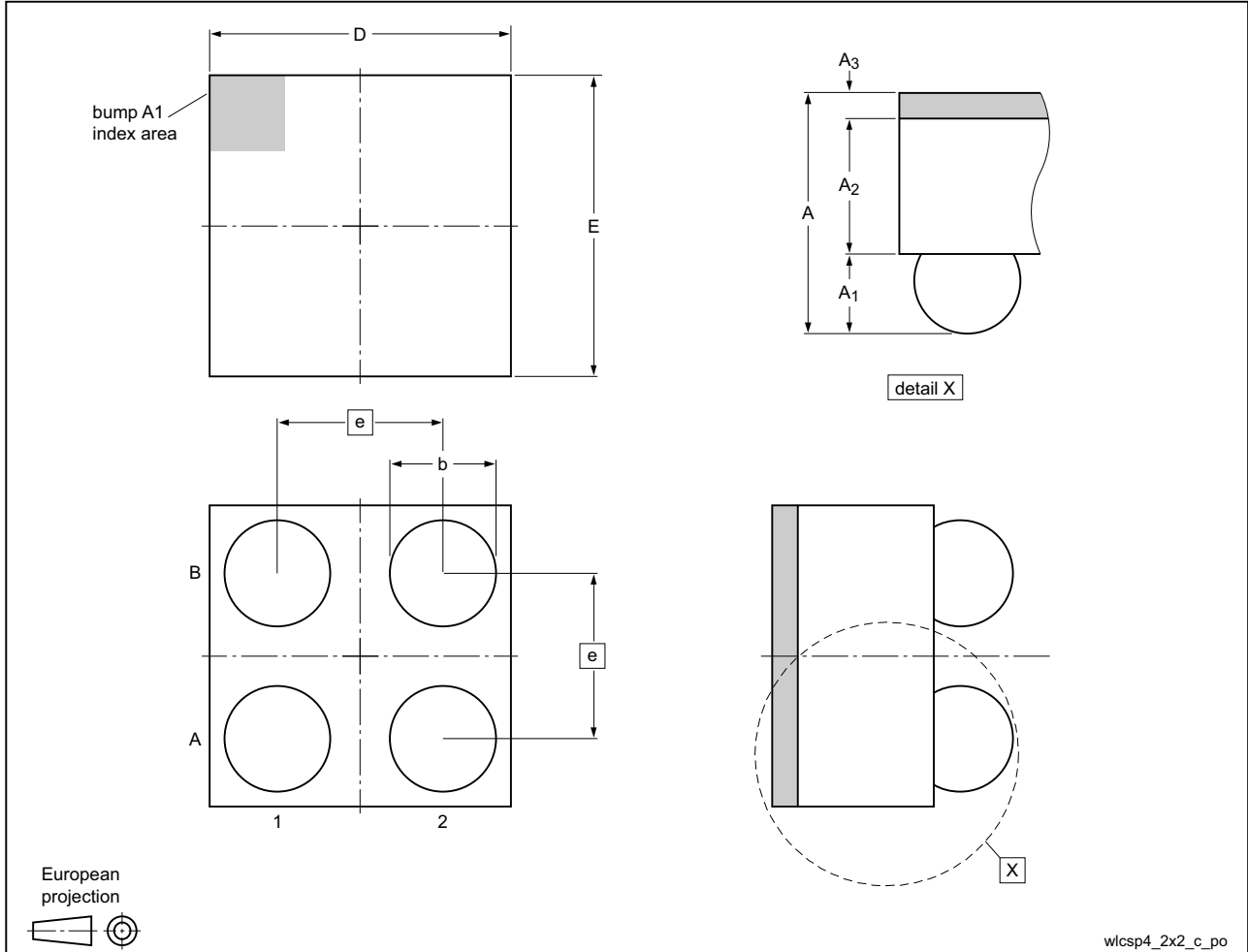

Fig 24. Package outline LD6836CX4/C (WLCSP4 with backside coating)

Table 20. Dimensions for Figure 24

Symbol	Min	Typ	Max	Unit
A	0.47	0.51	0.55	mm
A ₁	0.18	0.20	0.22	mm
A ₂	0.26	0.27	0.28	mm
A ₃	0.03	0.04	0.05	mm
b	0.21	0.26	0.31	mm
D	0.71	0.76	0.81	mm
E	0.71	0.76	0.81	mm
e	-	0.4	-	mm

Plastic surface-mounted package; 5 leads

SOT753

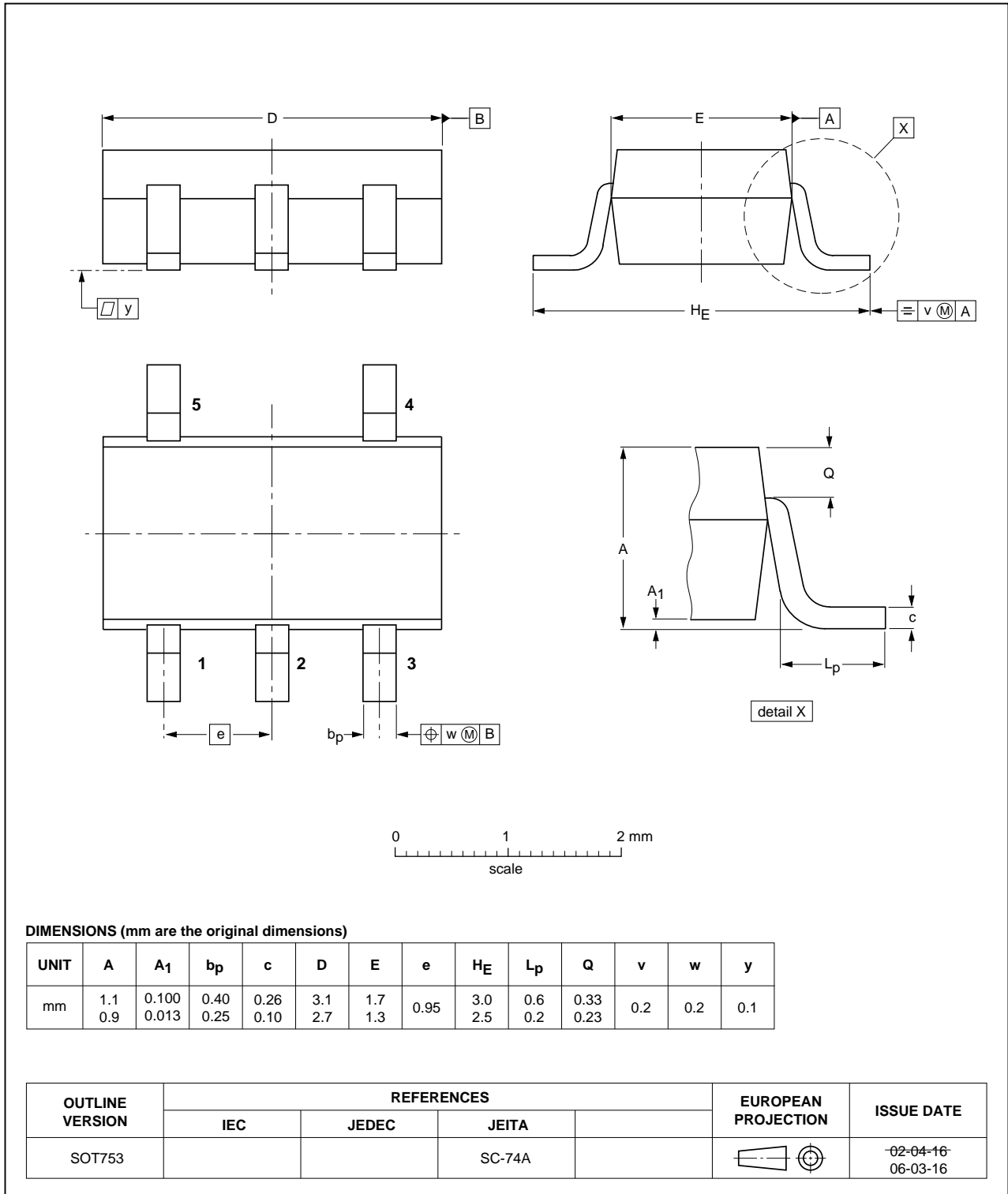

Fig 25. Package outline LD6836 series (SOT753)

14. Soldering

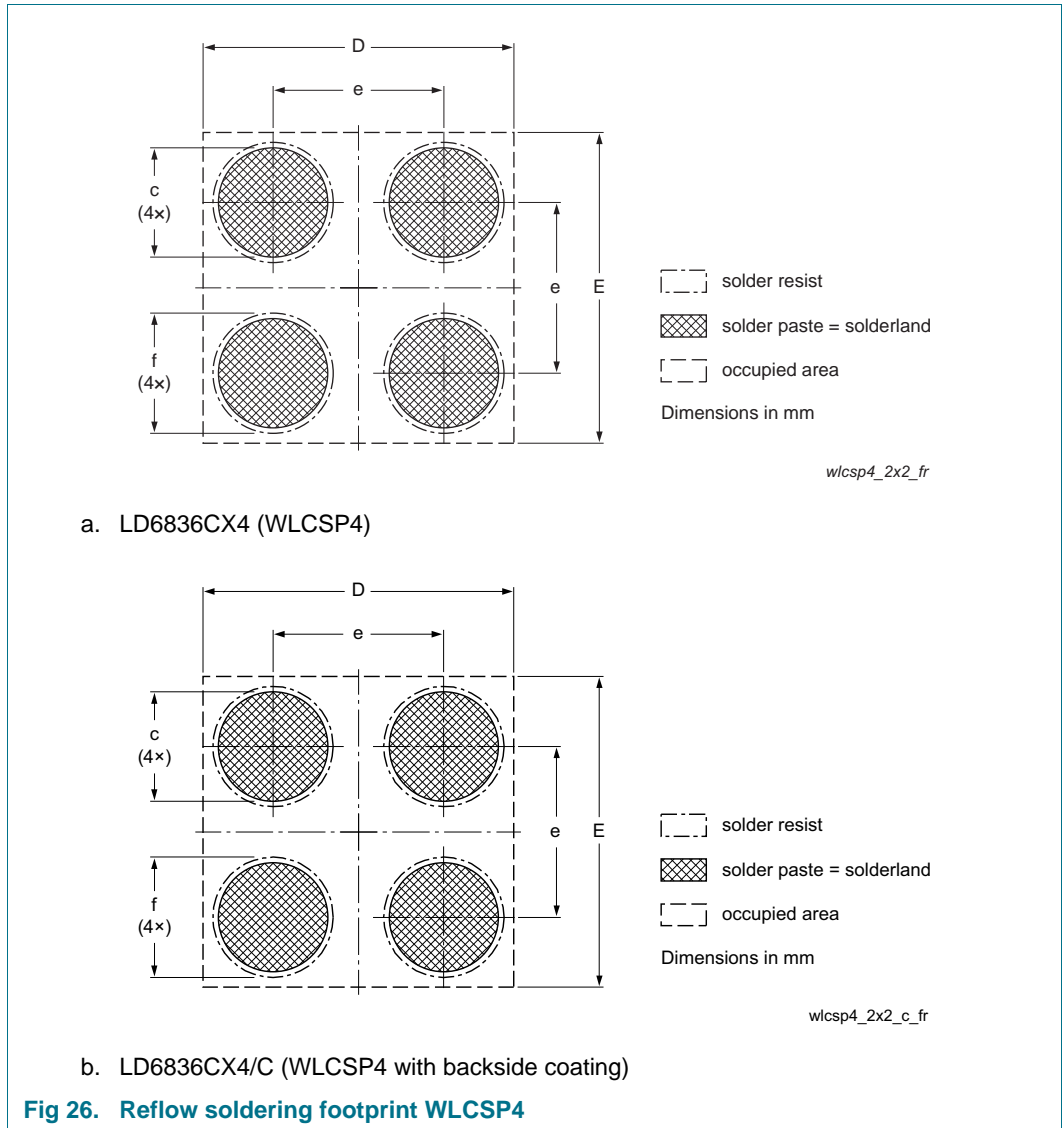

Table 21. Dimensions for Figure 26

Symbol	Min	Typ	Max	Unit
c	-	0.25	-	mm
D	0.71	0.76	0.81	mm
E	0.71	0.76	0.81	mm
e	-	0.4	-	mm
f	-	0.325	-	mm

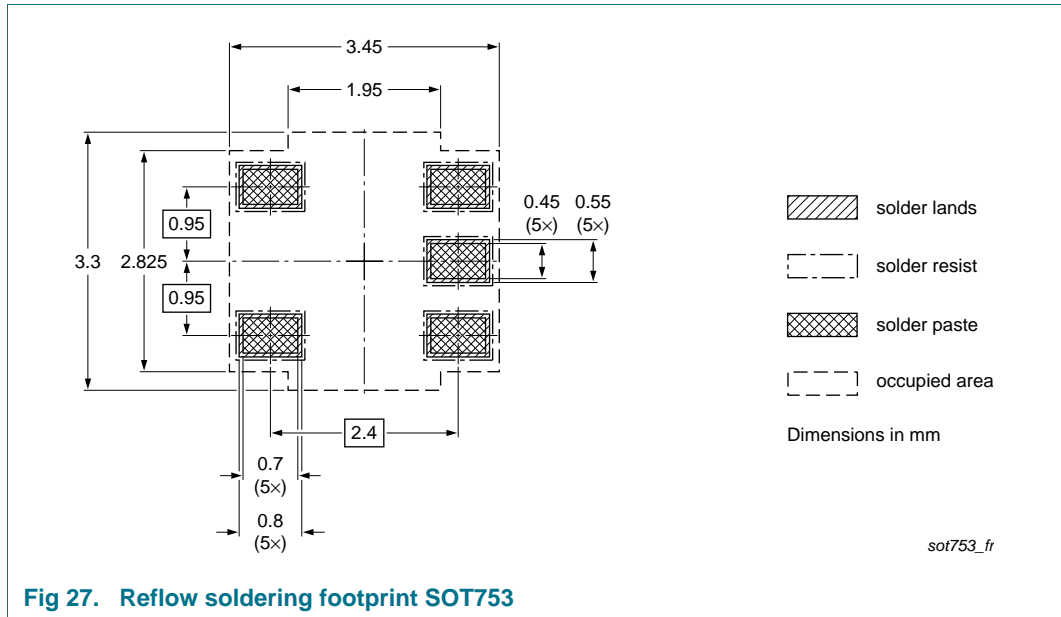

Fig 27. Reflow soldering footprint SOT753

15. Soldering of SMD packages

This text provides a very brief insight into a complex technology. A more in-depth account of soldering ICs can be found in Application Note AN10365 “Surface mount reflow soldering description”.

15.1 Introduction to soldering

Soldering is one of the most common methods through which packages are attached to Printed Circuit Boards (PCBs), to form electrical circuits. The soldered joint provides both the mechanical and the electrical connection. There is no single soldering method that is ideal for all IC packages. Wave soldering is often preferred when through-hole and Surface Mount Devices (SMDs) are mixed on one printed wiring board; however, it is not suitable for fine pitch SMDs. Reflow soldering is ideal for the small pitches and high densities that come with increased miniaturization.

15.2 Wave and reflow soldering

Wave soldering is a joining technology in which the joints are made by solder coming from a standing wave of liquid solder. The wave soldering process is suitable for the following:

- Through-hole components
- Leaded or leadless SMDs, which are glued to the surface of the printed circuit board

Not all SMDs can be wave soldered. Packages with solder balls, and some leadless packages which have solder lands underneath the body, cannot be wave soldered. Also, leaded SMDs with leads having a pitch smaller than ~0.6 mm cannot be wave soldered, due to an increased probability of bridging.

The reflow soldering process involves applying solder paste to a board, followed by component placement and exposure to a temperature profile. Leaded packages, packages with solder balls, and leadless packages are all reflow solderable.

Key characteristics in both wave and reflow soldering are:

- Board specifications, including the board finish, solder masks and vias
- Package footprints, including solder thieves and orientation
- The moisture sensitivity level of the packages
- Package placement
- Inspection and repair
- Lead-free soldering versus SnPb soldering

15.3 Wave soldering

Key characteristics in wave soldering are:

- Process issues, such as application of adhesive and flux, clinching of leads, board transport, the solder wave parameters, and the time during which components are exposed to the wave
- Solder bath specifications, including temperature and impurities

15.4 Reflow soldering

Key characteristics in reflow soldering are:

- Lead-free versus SnPb soldering; note that a lead-free reflow process usually leads to higher minimum peak temperatures (see [Figure 28](#)) than a SnPb process, thus reducing the process window
- Solder paste printing issues including smearing, release, and adjusting the process window for a mix of large and small components on one board
- Reflow temperature profile; this profile includes preheat, reflow (in which the board is heated to the peak temperature) and cooling down. It is imperative that the peak temperature is high enough for the solder to make reliable solder joints (a solder paste characteristic). In addition, the peak temperature must be low enough that the packages and/or boards are not damaged. The peak temperature of the package depends on package thickness and volume and is classified in accordance with [Table 22](#) and [23](#)

Table 22. SnPb eutectic process (from J-STD-020C)

Package thickness (mm)	Package reflow temperature (°C)	
	Volume (mm ³)	
	< 350	≥ 350
< 2.5	235	220
≥ 2.5	220	220

Table 23. Lead-free process (from J-STD-020C)

Package thickness (mm)	Package reflow temperature (°C)		
	Volume (mm ³)		
	< 350	350 to 2000	> 2000
< 1.6	260	260	260
1.6 to 2.5	260	250	245
> 2.5	250	245	245

Moisture sensitivity precautions, as indicated on the packing, must be respected at all times.

Studies have shown that small packages reach higher temperatures during reflow soldering, see [Figure 28](#).

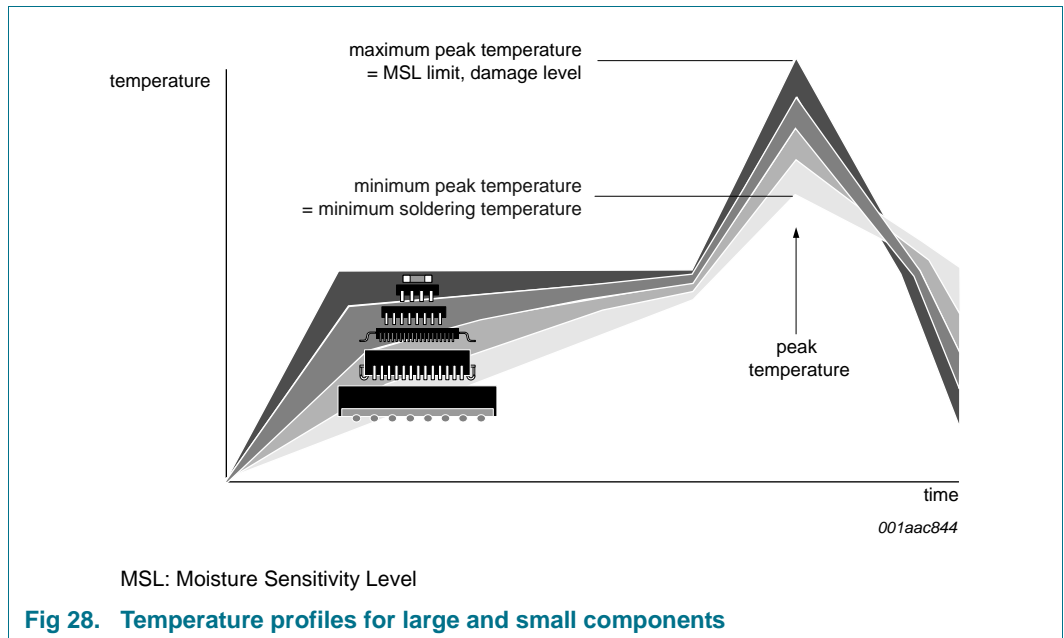

For further information on temperature profiles, refer to Application Note *AN10365 "Surface mount reflow soldering description"*.

16. Revision history

Table 24. Revision history

Document ID	Release date	Data sheet status	Change notice	Supersedes
LD6836_SER v.2	20121005	Product data sheet	-	LD6836_SER v.1
Modifications:	• Section 9.2 "Dropout" : corrected			
LD6836_SER v.1	20121004	Product data sheet	-	-

17. Legal information

17.1 Data sheet status

Document status ^{[1][2]}	Product status ^[3]	Definition
Objective [short] data sheet	Development	This document contains data from the objective specification for product development.
Preliminary [short] data sheet	Qualification	This document contains data from the preliminary specification.
Product [short] data sheet	Production	This document contains the product specification.

[1] Please consult the most recently issued document before initiating or completing a design.

[2] The term 'short data sheet' is explained in section "Definitions".

[3] The product status of device(s) described in this document may have changed since this document was published and may differ in case of multiple devices. The latest product status information is available on the Internet at URL <http://www.nxp.com>.

17.2 Definitions

Draft — The document is a draft version only. The content is still under internal review and subject to formal approval, which may result in modifications or additions. NXP Semiconductors does not give any representations or warranties as to the accuracy or completeness of information included herein and shall have no liability for the consequences of use of such information.

Short data sheet — A short data sheet is an extract from a full data sheet with the same product type number(s) and title. A short data sheet is intended for quick reference only and should not be relied upon to contain detailed and full information. For detailed and full information see the relevant full data sheet, which is available on request via the local NXP Semiconductors sales office. In case of any inconsistency or conflict with the short data sheet, the full data sheet shall prevail.

Product specification — The information and data provided in a Product data sheet shall define the specification of the product as agreed between NXP Semiconductors and its customer, unless NXP Semiconductors and customer have explicitly agreed otherwise in writing. In no event however, shall an agreement be valid in which the NXP Semiconductors product is deemed to offer functions and qualities beyond those described in the Product data sheet.

17.3 Disclaimers

Limited warranty and liability — Information in this document is believed to be accurate and reliable. However, NXP Semiconductors does not give any representations or warranties, expressed or implied, as to the accuracy or completeness of such information and shall have no liability for the consequences of use of such information. NXP Semiconductors takes no responsibility for the content in this document if provided by an information source outside of NXP Semiconductors.

In no event shall NXP Semiconductors be liable for any indirect, incidental, punitive, special or consequential damages (including - without limitation - lost profits, lost savings, business interruption, costs related to the removal or replacement of any products or rework charges) whether or not such damages are based on tort (including negligence), warranty, breach of contract or any other legal theory.

Notwithstanding any damages that customer might incur for any reason whatsoever, NXP Semiconductors' aggregate and cumulative liability towards customer for the products described herein shall be limited in accordance with the *Terms and conditions of commercial sale* of NXP Semiconductors.

Right to make changes — NXP Semiconductors reserves the right to make changes to information published in this document, including without limitation specifications and product descriptions, at any time and without notice. This document supersedes and replaces all information supplied prior to the publication hereof.

Suitability for use — NXP Semiconductors products are not designed, authorized or warranted to be suitable for use in life support, life-critical or safety-critical systems or equipment, nor in applications where failure or malfunction of an NXP Semiconductors product can reasonably be expected to result in personal injury, death or severe property or environmental damage. NXP Semiconductors and its suppliers accept no liability for inclusion and/or use of NXP Semiconductors products in such equipment or applications and therefore such inclusion and/or use is at the customer's own risk.

Applications — Applications that are described herein for any of these products are for illustrative purposes only. NXP Semiconductors makes no representation or warranty that such applications will be suitable for the specified use without further testing or modification.

Customers are responsible for the design and operation of their applications and products using NXP Semiconductors products, and NXP Semiconductors accepts no liability for any assistance with applications or customer product design. It is customer's sole responsibility to determine whether the NXP Semiconductors product is suitable and fit for the customer's applications and products planned, as well as for the planned application and use of customer's third party customer(s). Customers should provide appropriate design and operating safeguards to minimize the risks associated with their applications and products.

NXP Semiconductors does not accept any liability related to any default, damage, costs or problem which is based on any weakness or default in the customer's applications or products, or the application or use by customer's third party customer(s). Customer is responsible for doing all necessary testing for the customer's applications and products using NXP Semiconductors products in order to avoid a default of the applications and the products or of the application or use by customer's third party customer(s). NXP does not accept any liability in this respect.

Limiting values — Stress above one or more limiting values (as defined in the Absolute Maximum Ratings System of IEC 60134) will cause permanent damage to the device. Limiting values are stress ratings only and (proper) operation of the device at these or any other conditions above those given in the Recommended operating conditions section (if present) or the Characteristics sections of this document is not warranted. Constant or repeated exposure to limiting values will permanently and irreversibly affect the quality and reliability of the device.

Terms and conditions of commercial sale — NXP Semiconductors products are sold subject to the general terms and conditions of commercial sale, as published at <http://www.nxp.com/profile/terms>, unless otherwise agreed in a valid written individual agreement. In case an individual agreement is concluded only the terms and conditions of the respective agreement shall apply. NXP Semiconductors hereby expressly objects to applying the customer's general terms and conditions with regard to the purchase of NXP Semiconductors products by customer.

No offer to sell or license — Nothing in this document may be interpreted or construed as an offer to sell products that is open for acceptance or the grant, conveyance or implication of any license under any copyrights, patents or other industrial or intellectual property rights.

Export control — This document as well as the item(s) described herein may be subject to export control regulations. Export might require a prior authorization from competent authorities.

Quick reference data — The Quick reference data is an extract of the product data given in the Limiting values and Characteristics sections of this document, and as such is not complete, exhaustive or legally binding.

Non-automotive qualified products — Unless this data sheet expressly states that this specific NXP Semiconductors product is automotive qualified, the product is not suitable for automotive use. It is neither qualified nor tested in accordance with automotive testing or application requirements. NXP Semiconductors accepts no liability for inclusion and/or use of non-automotive qualified products in automotive equipment or applications.

In the event that customer uses the product for design-in and use in automotive applications to automotive specifications and standards, customer (a) shall use the product without NXP Semiconductors' warranty of the product for such automotive applications, use and specifications, and (b) whenever customer uses the product for automotive applications beyond NXP Semiconductors' specifications such use shall be solely at customer's own risk, and (c) customer fully indemnifies NXP Semiconductors for any liability, damages or failed product claims resulting from customer design and use of the product for automotive applications beyond NXP Semiconductors' standard warranty and NXP Semiconductors' product specifications.

17.4 Trademarks

Notice: All referenced brands, product names, service names and trademarks are the property of their respective owners.

18. Contact information

For more information, please visit: <http://www.nxp.com>

For sales office addresses, please send an email to: salesaddresses@nxp.com



19. Contents

1	Product profile	1	18	Contact information	27
1.1	General description	1	19	Contents	28
1.2	Features and benefits	1			
1.3	Applications	2			
2	Pinning information	2			
2.1	Pinning	2			
2.2	Pin description	2			
3	Ordering information	3			
3.1	Ordering options	3			
4	Block diagram	5			
5	Limiting values	6			
6	Recommended operating conditions	6			
7	Thermal characteristics	7			
8	Characteristics	7			
9	Dynamic behavior	9			
9.1	Power Supply Rejection Ratio (PSRR)	9			
9.2	Dropout	10			
9.3	Accuracy	10			
9.4	Quiescent current	11			
9.5	Noise	11			
9.6	Line Regulation	12			
9.7	Load Regulation	12			
9.8	Start-up and shutdown	13			
9.9	Enable threshold voltage	13			
10	Application information	14			
10.1	Capacitor values	14			
11	Test information	15			
11.1	Quality information	15			
12	Marking	15			
12.1	WLCSP4	15			
12.2	SOT753	16			
13	Package outline	18			
14	Soldering	21			
15	Soldering of SMD packages	22			
15.1	Introduction to soldering	22			
15.2	Wave and reflow soldering	22			
15.3	Wave soldering	23			
15.4	Reflow soldering	23			
16	Revision history	25			
17	Legal information	26			
17.1	Data sheet status	26			
17.2	Definitions	26			
17.3	Disclaimers	26			
17.4	Trademarks	27			







Please be aware that important notices concerning this document and the product(s) described herein, have been included in section 'Legal information'.

Looking for pricing, stock, or lifecycle information?

Click below to explore more details on WIN SOURCE:

-  [View LD6836TD/28P,125 on WIN SOURCE](#)
-  [NXP / Nexperia Information](#)

Optimize Your Supply Chain with WIN SOURCE Solutions

-  Global Sourcing Solution
-  Obsolete Management
-  Cost Control Management
-  Shortage Management
-  Alternative Solution
-  Excess Inventory Management