



THE DATASHEET OF LF444CM/NOPB



LF444 Quad Low Power JFET Input Operational Amplifier

Check for Samples: [LF444](#)

FEATURES

- **1/4 Supply Current of a LM148: 200 μ A/Amplifier (max)**
- **Low Input Bias Current: 50 pA (max)**
- **High Gain Bandwidth: 1 MHz**
- **High Slew Rate: 1 V/ μ s**
- **Low Noise Voltage for Low Power 35 nV/ $\sqrt{\text{Hz}}$**
- **Low Input Noise Current 0.01 pA/ $\sqrt{\text{Hz}}$**
- **High Input Impedance: $10^{12}\Omega$**
- **High Gain: 50k (min)**

DESCRIPTION

The LF444 quad low power operational amplifier provides many of the same AC characteristics as the industry standard LM148 while greatly improving the DC characteristics of the LM148. The amplifier has the same bandwidth, slew rate, and gain (10 k Ω load) as the LM148 and only draws one fourth the supply current of the LM148. In addition the well matched high voltage JFET input devices of the LF444 reduce the input bias and offset currents by a factor of 10,000 over the LM148. The LF444 also has a very low equivalent input noise voltage for a low power amplifier.

The LF444 is pin compatible with the LM148 allowing an immediate 4 times reduction in power drain in many applications. The LF444 should be used wherever low power dissipation and good electrical characteristics are the major considerations.

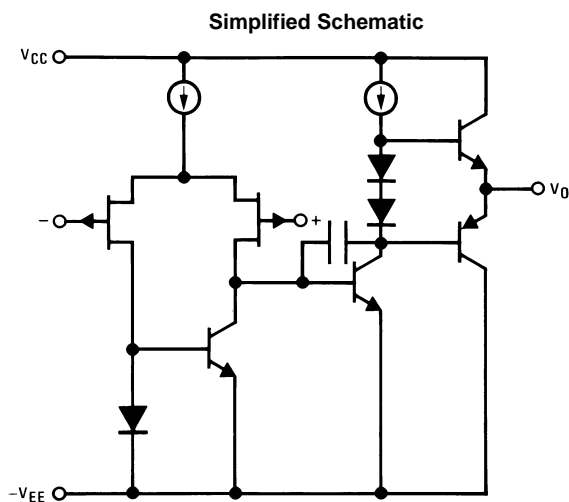
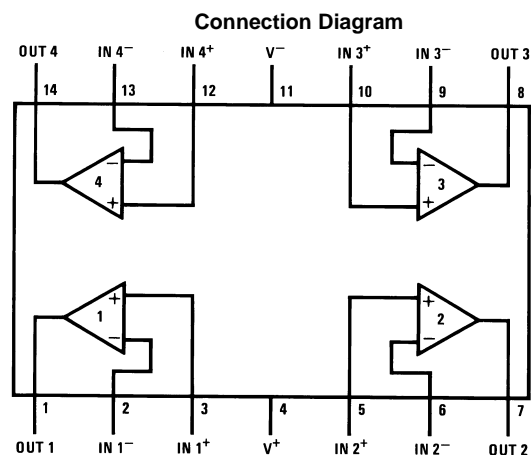
Figure 1. 1/4 Quad

**Figure 2. PDIP/SOIC Package
Top View
See Package Number NAK0014D, D0014A or
NFF0014A**

These devices have limited built-in ESD protection. The leads should be shorted together or the device placed in conductive foam during storage or handling to prevent electrostatic damage to the MOS gates.



Please be aware that an important notice concerning availability, standard warranty, and use in critical applications of Texas Instruments semiconductor products and disclaimers thereto appears at the end of this data sheet.

BI-FET is a trademark of Texas Instruments.

All other trademarks are the property of their respective owners.

Absolute Maximum Ratings⁽¹⁾⁽²⁾⁽³⁾

		LF444A	LF444
Supply Voltage		±22V	±18V
Differential Input Voltage		±38V	±30V
Input Voltage Range ⁽⁴⁾		±19V	±15V
Output Short Circuit Duration ⁽⁵⁾		Continuous	Continuous
		NAK Package	D, NFF Packages
Power Dissipation ⁽⁶⁾⁽⁷⁾		900 mW	670 mW
T _j max		150°C	115°C
θ _{JA} (Typical)		100°C/W	85°C/W
		LF444A/LF444	
Operating Temperature Range		See ⁽⁸⁾	
ESD Tolerance ⁽⁹⁾		Rating to be determined	
Storage Temperature Range		-65°C ≤ T _A ≤ 150°C	
Soldering Information	Dual-In-Line Packages (Soldering, 10 sec.)	260°C	
	Small Outline Package	Vapor Phase (60 sec.)	215°C
		Infrared (15 sec.)	220°C

- (1) Absolute Maximum Ratings indicate limits beyond which damage to the device may occur. Operating ratings indicate conditions for which the device is functional, but do not ensure specific performance limits. Electrical Characteristics state DC and AC electrical specifications under particular test conditions which ensure specific performance limits. This assumes that the device is within the Operating Ratings. Specifications are not ensured for parameters where no limit is given, however, the typical value is a good indication of device performance.
- (2) If Military/Aerospace specified devices are required, please contact the TI Sales Office/ Distributors for availability and specifications.
- (3) Refer to RETS444X for LF444MD military specifications.
- (4) Unless otherwise specified the absolute maximum negative input voltage is equal to the negative power supply voltage.
- (5) Any of the amplifier outputs can be shorted to ground indefinitely, however, more than one should not be simultaneously shorted as the maximum junction temperature will be exceeded.
- (6) For operating at elevated temperature, these devices must be derated based on a thermal resistance of θ_{JA}.
- (7) Max. Power Dissipation is defined by the package characteristics. Operating the part near the Max. Power Dissipation may cause the part to operate outside ensured limits.
- (8) The LF444A is available in both the commercial temperature range 0°C ≤ T_A ≤ 70°C and the military temperature range -55°C ≤ T_A ≤ 125°C. The LF444 is available in the commercial temperature range only. The temperature range is designated by the position just before the package type in the device number. A “C” indicates the commercial temperature range and an “M” indicates the military temperature range. The military temperature range is available in “NAK” package only.
- (9) Human body model, 1.5 kΩ in series with 100 pF.

DC Electrical Characteristics⁽¹⁾

Symbol	Parameter	Conditions	LF444A			LF444			Units
			Min	Typ	Max	Min	Typ	Max	
V _{OS}	Input Offset Voltage	R _S = 10k, T _A = 25°C		2	5	3	10	mV	
		0°C ≤ T _A ≤ +70°C			6.5		12	mV	
		-55°C ≤ T _A ≤ +125°C			8			mV	
ΔV _{OS} /ΔT	Average TC of Input Offset Voltage	R _S = 10 kΩ		10		10		μV/°C	
I _{OS}	Input Offset Current	V _S = ±15V ⁽¹⁾⁽²⁾	T _J = 25°C	5	25	5	50	pA	
			T _J = 70°C		1.5		1.5	nA	
			T _J = 125°C		10			nA	
I _B	Input Bias Current	V _S = ±15V ⁽¹⁾⁽²⁾	T _J = 25°C	10	50	10	100	pA	
			T _J = 70°C		3		3	nA	
			T _J = 125°C		20			nA	

- (1) Unless otherwise specified the specifications apply over the full temperature range and for V_S = ±20V for the LF444A and for V_S = ±15V for the LF444. V_{OS}, I_B, and I_{OS} are measured at V_{CM} = 0.
- (2) The input bias currents are junction leakage currents which approximately double for every 10°C increase in the junction temperature, T_J. Due to limited production test time, the input bias currents measured are correlated to junction temperature. In normal operation the junction temperature rises above the ambient temperature as a result of internal power dissipation, P_D. T_J = T_A + θ_{JA}P_D where θ_{JA} is the thermal resistance from junction to ambient. Use of a heat sink is recommended if input bias current is to be kept to a minimum.

DC Electrical Characteristics ⁽¹⁾ (continued)

Symbol	Parameter	Conditions	LF444A			LF444			Units
			Min	Typ	Max	Min	Typ	Max	
R _{IN}	Input Resistance	T _J = 25°C		10 ¹²			10 ¹²		Ω
A _{VOL}	Large Signal Voltage Gain	V _S = ±15V, V _O = ±10V	50	100		25	100		V/mV
		R _L = 10 kΩ, T _A = 25°C							
		Over Temperature	25			15			V/mV
V _O	Output Voltage Swing	V _S = ±15V, R _L = 10 kΩ	±12	±13		±12	±13		V
V _{CM}	Input Common-Mode Voltage Range		±16	+18		±11	+14		V
				-17			-12		V
CMRR	Common-Mode Rejection Ratio	R _S ≤ 10 kΩ	80	100		70	95		dB
PSRR	Supply Voltage Rejection Ratio	See ⁽³⁾	80	100		70	90		dB
I _S	Supply Current			0.6	0.8		0.6	1.0	mA

(3) Supply voltage rejection ratio is measured for both supply magnitudes increasing or decreasing simultaneously in accordance with common practice from ±15V to ±5V for the LF444 and from ±20V to ±5V for the LF444A.

AC Electrical Characteristics ⁽¹⁾

Symbol	Parameter	Conditions	LF444A			LF444			Units
			Min	Typ	Max	Min	Typ	Max	
	Amplifier-to-Amplifier Coupling			-120			-120		dB
SR	Slew Rate	V _S = ±15V, T _A = 25°C		1			1		V/μs
GBW	Gain-Bandwidth Product	V _S = ±15V, T _A = 25°C		1			1		MHz
e _n	Equivalent Input Noise Voltage	T _A = 25°C, R _S = 100Ω, f = 1 kHz		35			35		nV/√Hz
i _n	Equivalent Input Noise Current	T _A = 25°C, f = 1 kHz		0.01			0.01		pA/√Hz

(1) Unless otherwise specified the specifications apply over the full temperature range and for V_S = ±20V for the LF444A and for V_S = ±15V for the LF444. V_{OS}, I_B, and I_{OS} are measured at V_{CM} = 0.

Typical Performance Characteristics

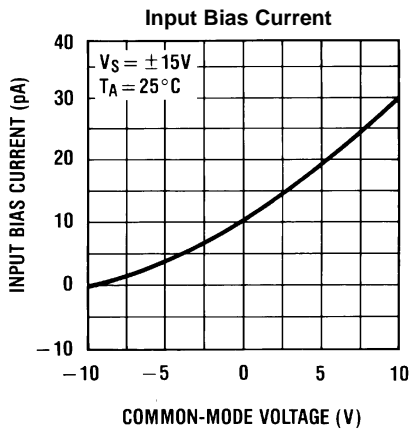

Figure 3.

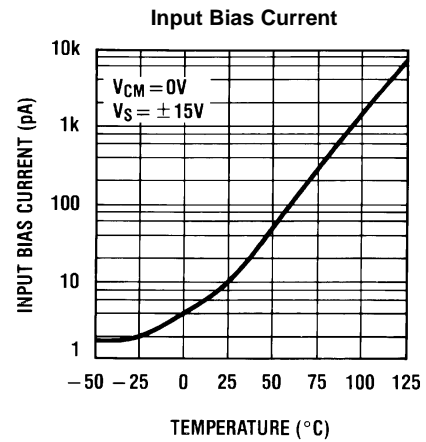

Figure 4.

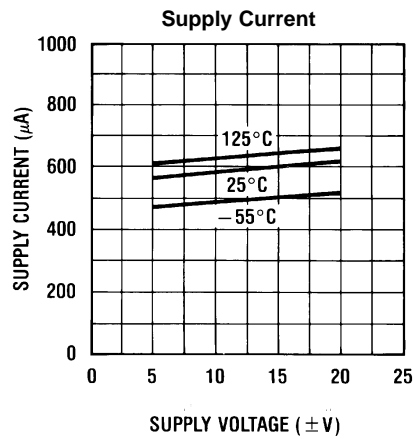

Figure 5.

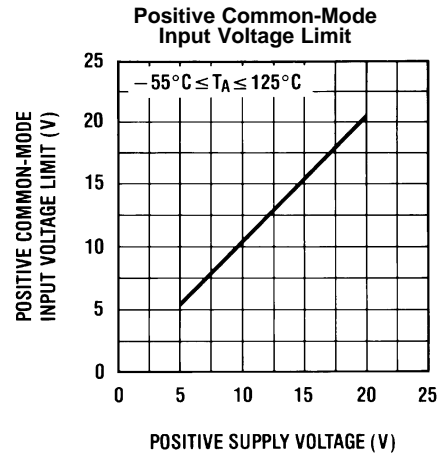

Figure 6.

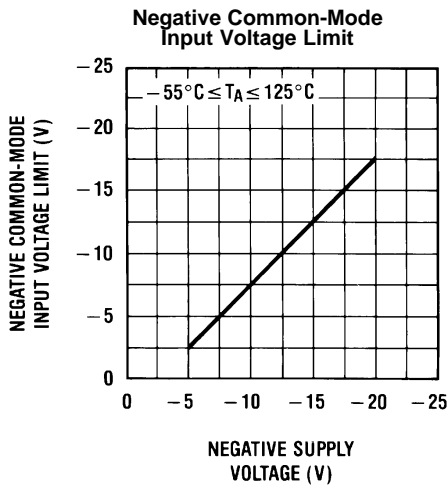

Figure 7.

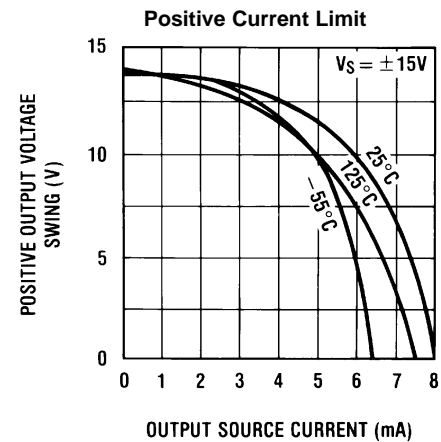

Figure 8.

Typical Performance Characteristics (continued)

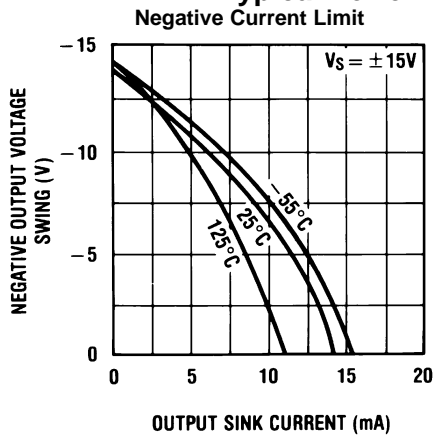

Figure 9.

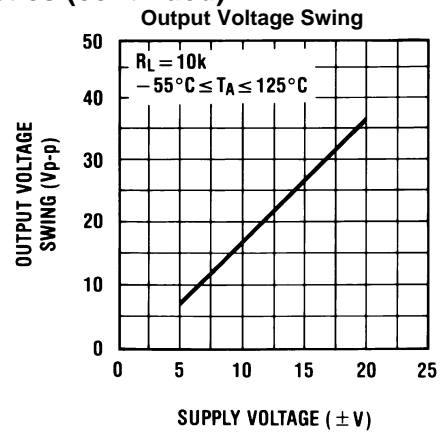

Figure 10.

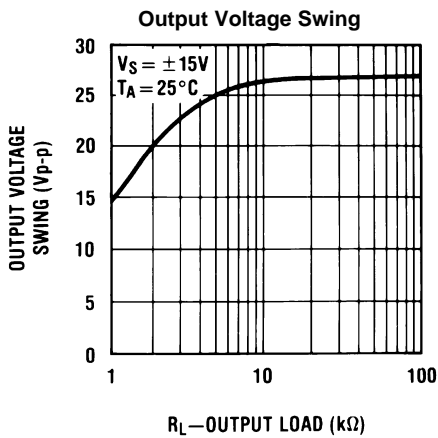

Figure 11.

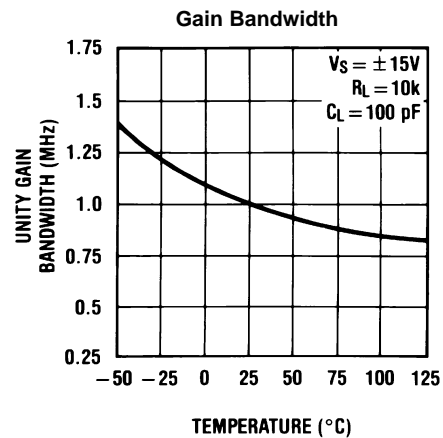

Figure 12.

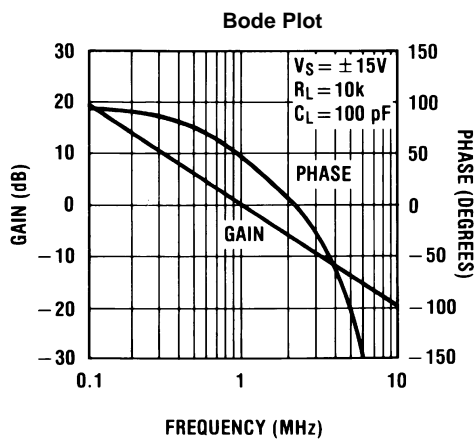

Figure 13.

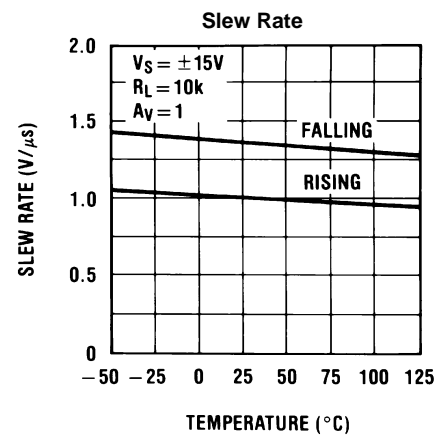

Figure 14.

Typical Performance Characteristics (continued)

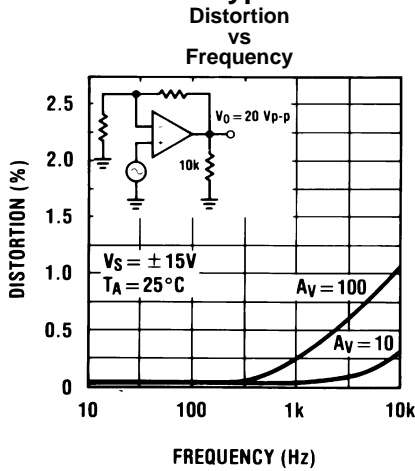

Figure 15.

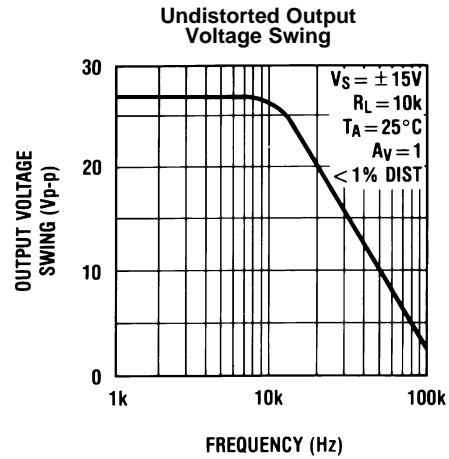

Figure 16.

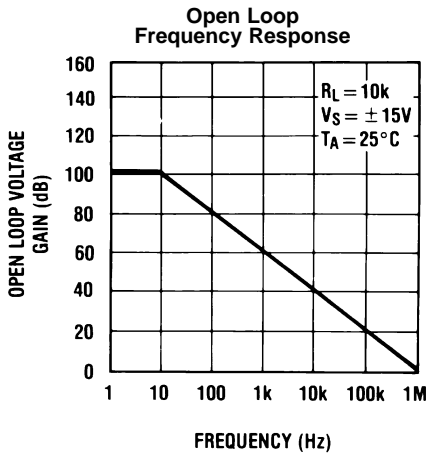

Figure 17.

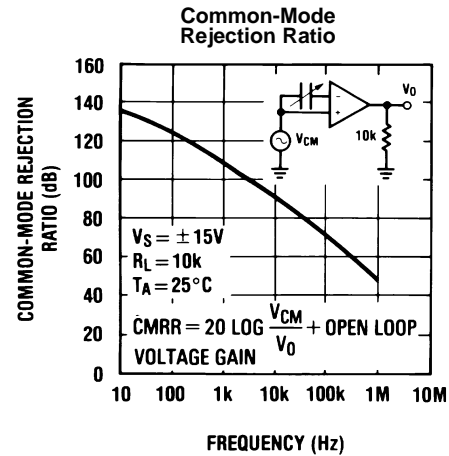

Figure 18.

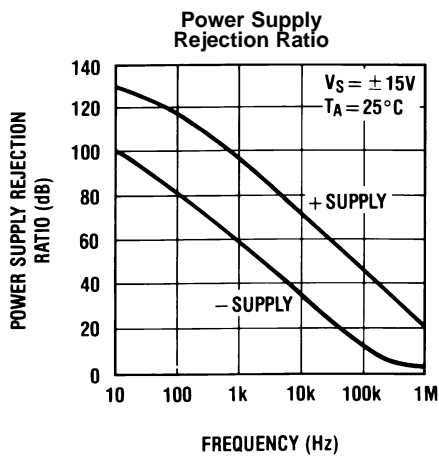

Figure 19.

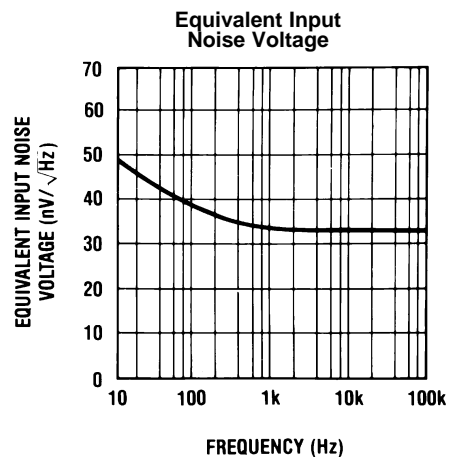

Figure 20.

Typical Performance Characteristics (continued)

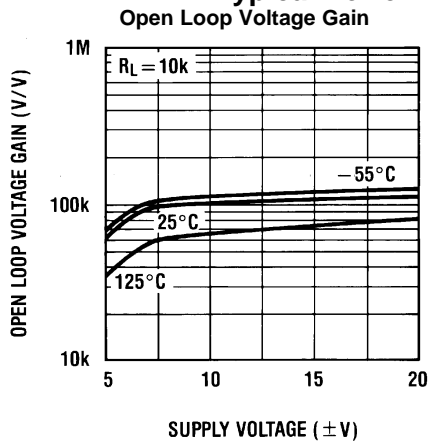

Figure 21.

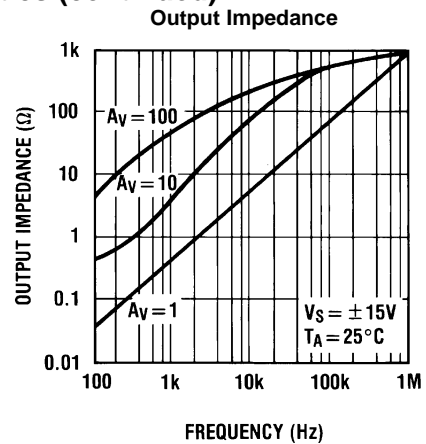

Figure 22.

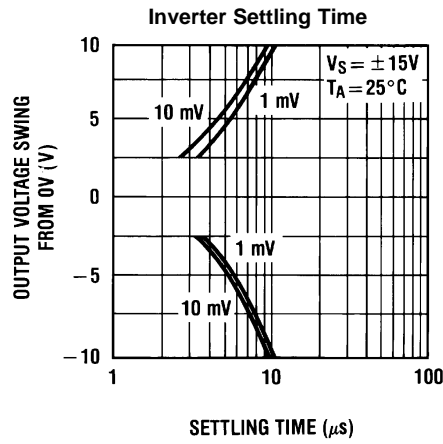
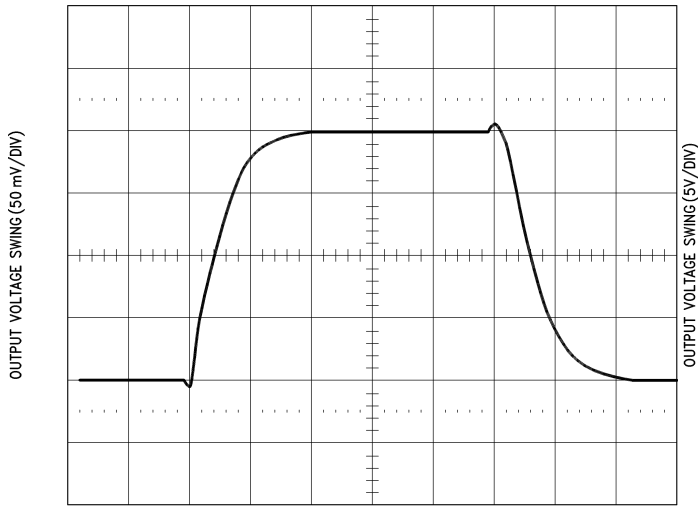

Figure 23.

Pulse Response

$R_L = 10\text{ k}\Omega, C_L = 10\text{ pF}$

Small Signal Inverting



TIME (0.5 $\mu\text{s/DIV}$)
Figure 24.

Large Signal Inverting

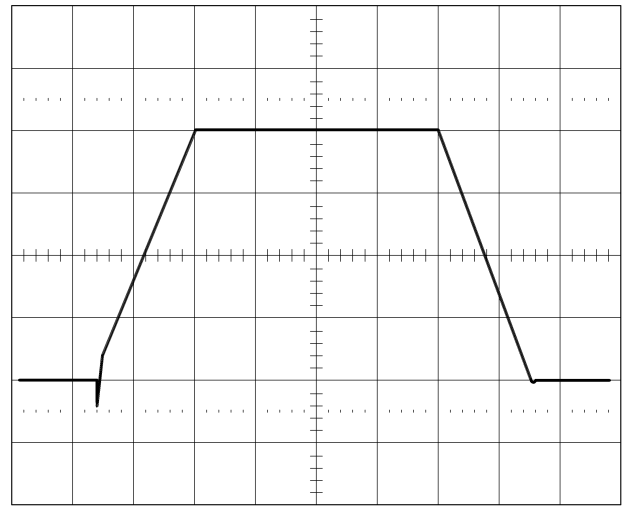

TIME (10 $\mu\text{s/DIV}$)
Figure 25.

Small Signal Non-Inverting

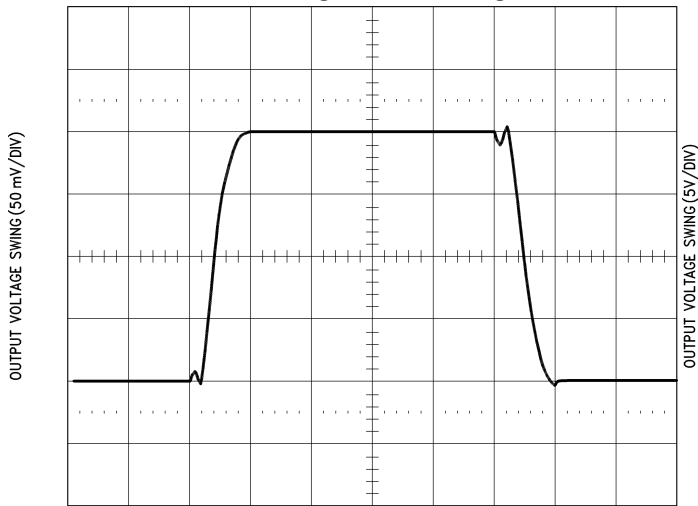

TIME (0.5 $\mu\text{s/DIV}$)
Figure 26.

Large Signal Non-Inverting

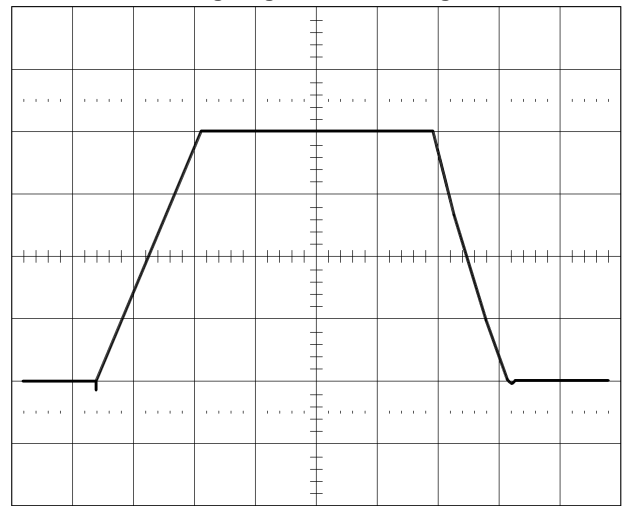

TIME (10 $\mu\text{s/DIV}$)
Figure 27.

APPLICATION HINTS

This device is a quad low power op amp with JFET input devices (BI-FET™). These JFETs have large reverse breakdown voltages from gate to source and drain eliminating the need for clamps across the inputs. Therefore, large differential input voltages can easily be accommodated without a large increase in input current. The maximum differential input voltage is independent of the supply voltages. However, neither of the input voltages should be allowed to exceed the negative supply as this will cause large currents to flow which can result in a destroyed unit.

Exceeding the negative common-mode limit on either input will force the output to a high state, potentially causing a reversal of phase to the output. Exceeding the negative common-mode limit on both inputs will force the amplifier output to a high state. In neither case does a latch occur since raising the input back within the common-mode range again puts the input stage and thus the amplifier in a normal operating mode.

Exceeding the positive common-mode limit on a single input will not change the phase of the output; however, if both inputs exceed the limit, the output of the amplifier will be forced to a high state.

The amplifiers will operate with a common-mode input voltage equal to the positive supply; however, the gain bandwidth and slew rate may be decreased in this condition. When the negative common-mode voltage swings to within 3V of the negative supply, an increase in input offset voltage may occur.

Each amplifier is individually biased to allow normal circuit operation with power supplies of $\pm 3.0V$. Supply voltages less than these may degrade the common-mode rejection and restrict the output voltage swing.

The amplifiers will drive a 10 k Ω load resistance to $\pm 10V$ over the full temperature range. If the amplifier is forced to drive heavier load currents, however, an increase in input offset voltage may occur on the negative voltage swing and finally reach an active current limit on both positive and negative swings.

Precautions should be taken to ensure that the power supply for the integrated circuit never becomes reversed in polarity or that the unit is not inadvertently installed backwards in a socket as an unlimited current surge through the resulting forward diode within the IC could cause fusing of the internal conductors and result in a destroyed unit.

As with most amplifiers, care should be taken with lead dress, component placement and supply decoupling in order to ensure stability. For example, resistors from the output to an input should be placed with the body close to the input to minimize “pick-up” and maximize the frequency of the feedback pole by minimizing the capacitance from the input to ground.

A feedback pole is created when the feedback around any amplifier is resistive. The parallel resistance and capacitance from the input of the device (usually the inverting input) to AC ground set the frequency of the pole. In many instances the frequency of this pole is much greater than the expected 3 dB frequency of the closed loop gain and consequently there is negligible effect on stability margin. However, if the feedback pole is less than approximately 6 times the expected 3 dB frequency a lead capacitor should be placed from the output to the input of the op amp. The value of the added capacitor should be such that the RC time constant of this capacitor and the resistance it parallels is greater than or equal to the original feedback pole time constant.

Typical Application

Figure 28. pH Probe Amplifier/Temperature Compensator

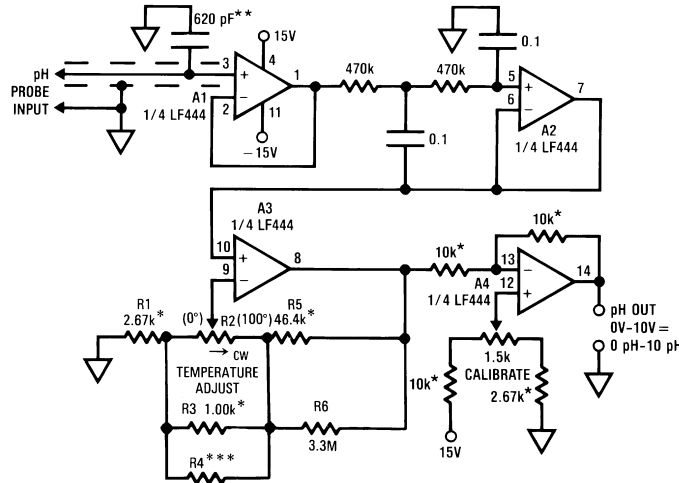

***For R2 = 50k, R4 = 330k ±1%
 For R2 = 100k, R4 = 75k ±1%
 For R2 = 200k, R4 = 56k ±1%

**Polystyrene

*Film resistor type RN60C

To calibrate, insert probe in pH =7 solution. Set the "TEMPERATURE ADJUST" pot, R2, to correspond to the solution temperature: full clockwise for 0°C, and proportionately for intermediate temperatures, using a turns-counting dial.

Then set "CALIBRATE" pot so output reads 7V.

Typical probe = Ingold Electrodes #465-35

Detailed Schematic

Figure 29. 1/4 Quad

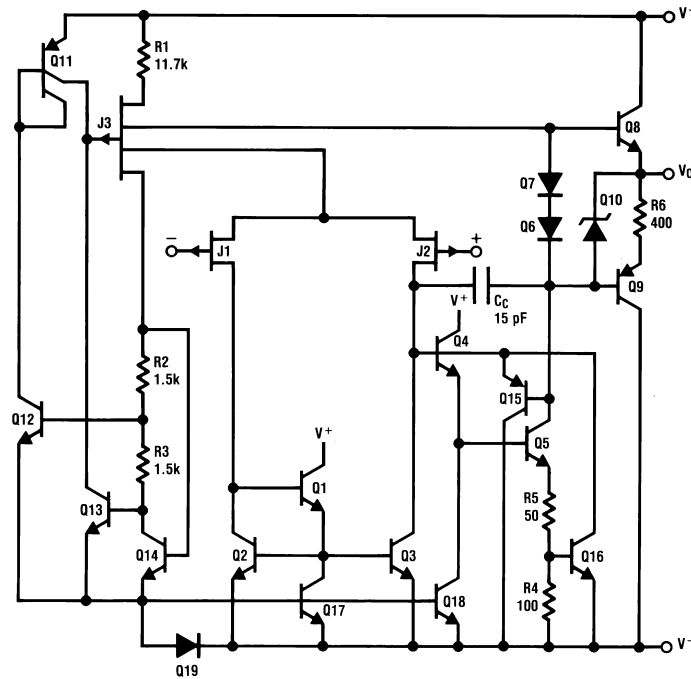

REVISION HISTORY

Changes from Revision C (March 2013) to Revision D	Page
<hr/> <ul style="list-style-type: none">• Changed layout of National Data Sheet to TI format	<hr/> 10

PACKAGING INFORMATION

Orderable Device	Status (1)	Package Type	Package Drawing	Pins	Package Qty	Eco Plan (2)	Lead/Ball Finish (6)	MSL Peak Temp (3)	Op Temp (°C)	Device Marking (4/5)	Samples
LF444ACN/NOPB	ACTIVE	PDIP	NFF	14	25	Green (RoHS & no Sb/Br)	CU SN	Level-1-NA-UNLIM	0 to 70	LF444ACN	Samples
LF444CM	NRND	SOIC	D	14	55	TBD	Call TI	Call TI	0 to 70	LF444CM	
LF444CM/NOPB	ACTIVE	SOIC	D	14	55	Green (RoHS & no Sb/Br)	CU SN	Level-1-260C-UNLIM	0 to 70	LF444CM	Samples
LF444CMX/NOPB	ACTIVE	SOIC	D	14	2500	Green (RoHS & no Sb/Br)	CU SN	Level-1-260C-UNLIM	0 to 70	LF444CM	Samples
LF444CN/NOPB	ACTIVE	PDIP	NFF	14	25	Green (RoHS & no Sb/Br)	CU SN	Level-1-NA-UNLIM	0 to 70	LF444CN	Samples

(1) The marketing status values are defined as follows:

ACTIVE: Product device recommended for new designs.

LIFEBUY: TI has announced that the device will be discontinued, and a lifetime-buy period is in effect.

NRND: Not recommended for new designs. Device is in production to support existing customers, but TI does not recommend using this part in a new design.

PREVIEW: Device has been announced but is not in production. Samples may or may not be available.

OBSOLETE: TI has discontinued the production of the device.

(2) Eco Plan - The planned eco-friendly classification: Pb-Free (RoHS), Pb-Free (RoHS Exempt), or Green (RoHS & no Sb/Br) - please check <http://www.ti.com/productcontent> for the latest availability information and additional product content details.

TBD: The Pb-Free/Green conversion plan has not been defined.

Pb-Free (RoHS): TI's terms "Lead-Free" or "Pb-Free" mean semiconductor products that are compatible with the current RoHS requirements for all 6 substances, including the requirement that lead not exceed 0.1% by weight in homogeneous materials. Where designed to be soldered at high temperatures, TI Pb-Free products are suitable for use in specified lead-free processes.

Pb-Free (RoHS Exempt): This component has a RoHS exemption for either 1) lead-based flip-chip solder bumps used between the die and package, or 2) lead-based die adhesive used between the die and leadframe. The component is otherwise considered Pb-Free (RoHS compatible) as defined above.

Green (RoHS & no Sb/Br): TI defines "Green" to mean Pb-Free (RoHS compatible), and free of Bromine (Br) and Antimony (Sb) based flame retardants (Br or Sb do not exceed 0.1% by weight in homogeneous material)

(3) MSL, Peak Temp. - The Moisture Sensitivity Level rating according to the JEDEC industry standard classifications, and peak solder temperature.

(4) There may be additional marking, which relates to the logo, the lot trace code information, or the environmental category on the device.

(5) Multiple Device Markings will be inside parentheses. Only one Device Marking contained in parentheses and separated by a "~" will appear on a device. If a line is indented then it is a continuation of the previous line and the two combined represent the entire Device Marking for that device.

(6) Lead/Ball Finish - Orderable Devices may have multiple material finish options. Finish options are separated by a vertical ruled line. Lead/Ball Finish values may wrap to two lines if the finish value exceeds the maximum column width.

Important Information and Disclaimer: The information provided on this page represents TI's knowledge and belief as of the date that it is provided. TI bases its knowledge and belief on information provided by third parties, and makes no representation or warranty as to the accuracy of such information. Efforts are underway to better integrate information from third parties. TI has taken and continues to take reasonable steps to provide representative and accurate information but may not have conducted destructive testing or chemical analysis on incoming materials and chemicals. TI and TI suppliers consider certain information to be proprietary, and thus CAS numbers and other limited information may not be available for release.

In no event shall TI's liability arising out of such information exceed the total purchase price of the TI part(s) at issue in this document sold by TI to Customer on an annual basis.

TAPE AND REEL INFORMATION



QUADRANT ASSIGNMENTS FOR PIN 1 ORIENTATION IN TAPE



*All dimensions are nominal

Device	Package Type	Package Drawing	Pins	SPQ	Reel Diameter (mm)	Reel Width W1 (mm)	A0 (mm)	B0 (mm)	K0 (mm)	P1 (mm)	W (mm)	Pin1 Quadrant
LF444CMX/NOPB	SOIC	D	14	2500	330.0	16.4	6.5	9.35	2.3	8.0	16.0	Q1

TAPE AND REEL BOX DIMENSIONS



*All dimensions are nominal

Device	Package Type	Package Drawing	Pins	SPQ	Length (mm)	Width (mm)	Height (mm)
LF444CMX/NOPB	SOIC	D	14	2500	367.0	367.0	35.0

D (R-PDSO-G14)

PLASTIC SMALL OUTLINE

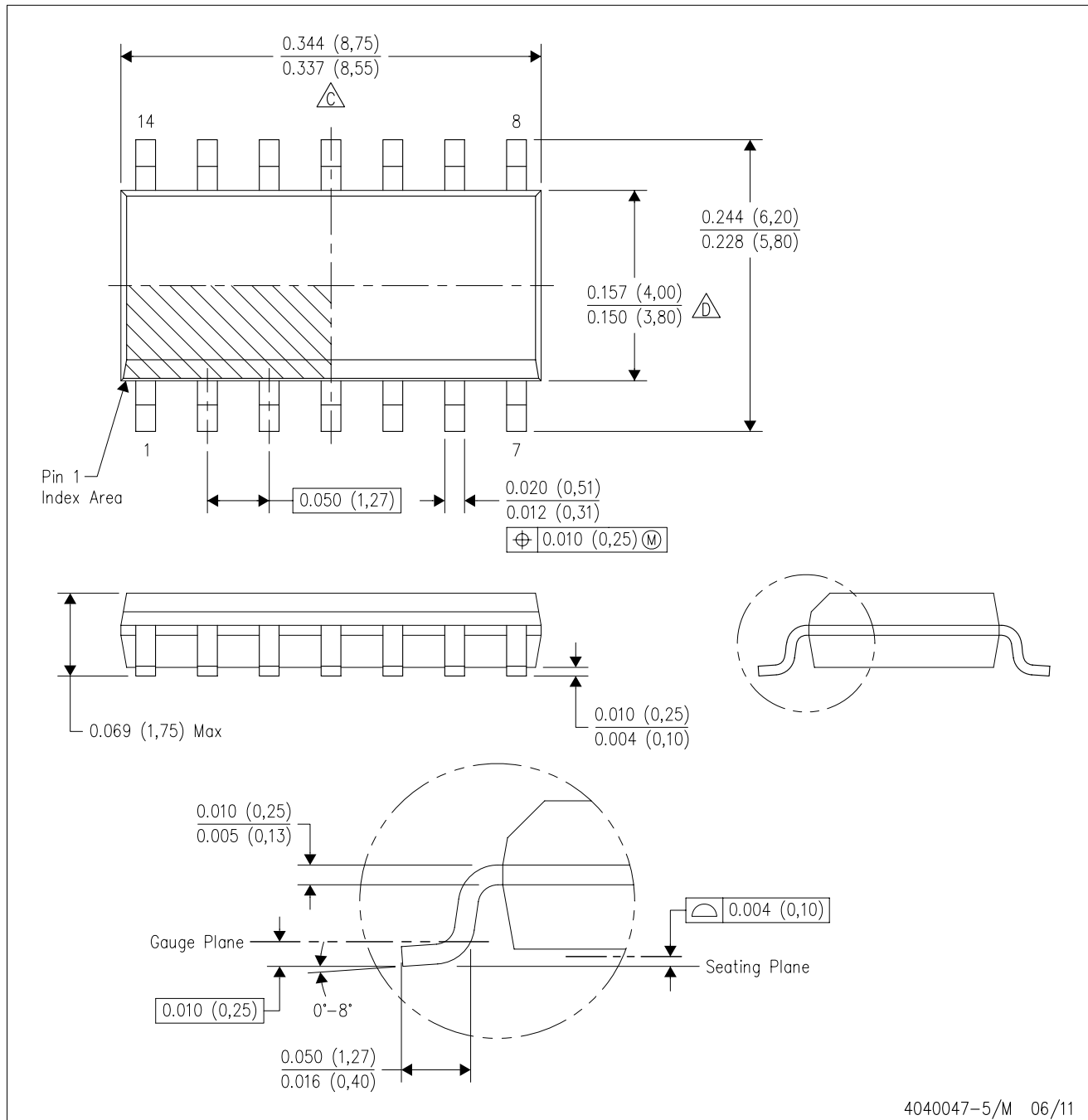

- NOTES:
- A. All linear dimensions are in inches (millimeters).
 - B. This drawing is subject to change without notice.
 -  Body length does not include mold flash, protrusions, or gate burrs. Mold flash, protrusions, or gate burrs shall not exceed 0.006 (0,15) each side.
 -  Body width does not include interlead flash. Interlead flash shall not exceed 0.017 (0,43) each side.
 - E. Reference JEDEC MS-012 variation AB.

D (R-PDSO-G14)

PLASTIC SMALL OUTLINE



- NOTES:
- A. All linear dimensions are in millimeters.
 - B. This drawing is subject to change without notice.
 - C. Publication IPC-7351 is recommended for alternate designs.
 - D. Laser cutting apertures with trapezoidal walls and also rounding corners will offer better paste release. Customers should contact their board assembly site for stencil design recommendations. Refer to IPC-7525 for other stencil recommendations.
 - E. Customers should contact their board fabrication site for solder mask tolerances between and around signal pads.

N0014A

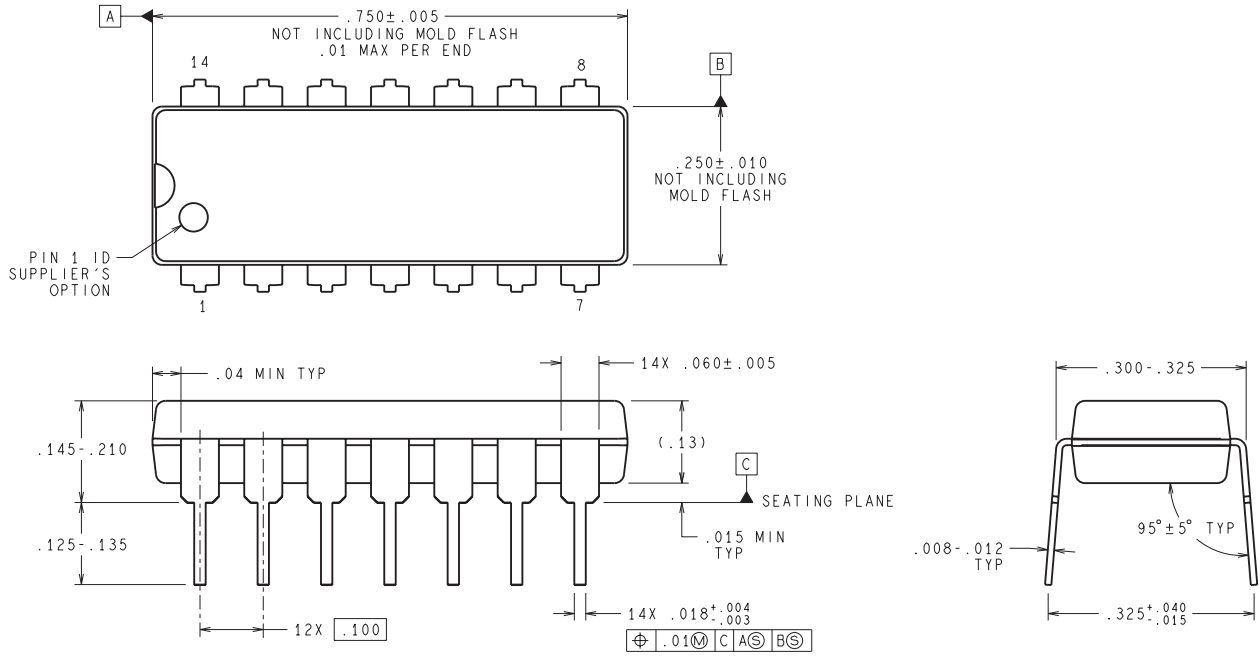

DIMENSIONS ARE IN INCHES
 DIMENSIONS IN () FOR REFERENCE ONLY

N14A (Rev G)

IMPORTANT NOTICE AND DISCLAIMER

TI PROVIDES TECHNICAL AND RELIABILITY DATA (INCLUDING DATASHEETS), DESIGN RESOURCES (INCLUDING REFERENCE DESIGNS), APPLICATION OR OTHER DESIGN ADVICE, WEB TOOLS, SAFETY INFORMATION, AND OTHER RESOURCES "AS IS" AND WITH ALL FAULTS, AND DISCLAIMS ALL WARRANTIES, EXPRESS AND IMPLIED, INCLUDING WITHOUT LIMITATION ANY IMPLIED WARRANTIES OF MERCHANTABILITY, FITNESS FOR A PARTICULAR PURPOSE OR NON-INFRINGEMENT OF THIRD PARTY INTELLECTUAL PROPERTY RIGHTS.

These resources are intended for skilled developers designing with TI products. You are solely responsible for (1) selecting the appropriate TI products for your application, (2) designing, validating and testing your application, and (3) ensuring your application meets applicable standards, and any other safety, security, or other requirements. These resources are subject to change without notice. TI grants you permission to use these resources only for development of an application that uses the TI products described in the resource. Other reproduction and display of these resources is prohibited. No license is granted to any other TI intellectual property right or to any third party intellectual property right. TI disclaims responsibility for, and you will fully indemnify TI and its representatives against, any claims, damages, costs, losses, and liabilities arising out of your use of these resources.

TI's products are provided subject to TI's Terms of Sale (www.ti.com/legal/termsofsale.html) or other applicable terms available either on ti.com or provided in conjunction with such TI products. TI's provision of these resources does not expand or otherwise alter TI's applicable warranties or warranty disclaimers for TI products.

Mailing Address: Texas Instruments, Post Office Box 655303, Dallas, Texas 75265
Copyright © 2019, Texas Instruments Incorporated







Looking for pricing, stock, or lifecycle information?

Click below to explore more details on WIN SOURCE:

 [View LF444CM/NOPB](#) on WIN SOURCE

 [Texas Instruments](#) Information

Optimize Your Supply Chain with WIN SOURCE Solutions

-  Global Sourcing Solution
-  Obsolete Management
-  Cost Control Management
-  Shortage Management
-  Alternative Solution
-  Excess Inventory Management