



# Silicon Transistor

## NE97833 / 2SA1978

JEITA Part No.

### PNP EPITAXIAL SILICON TRANSISTOR MICROWAVE AMPLIFIER

#### FEATURES

- High  $f_T$   
 $f_T = 5.5$  GHz TYP.
- $|S_{21e}|^2 = 10.0$  dB TYP. @  $f = 1.0$  GHz,  $V_{CE} = -10$  V,  $I_C = -15$  mA
- High speed switching characteristics
- Equivalent NPN transistor is the NE02133 / 2SC2351.
- Alternative of the 2SA1424.

#### ABSOLUTE MAXIMUM RATINGS ( $T_A = 25$ °C)

Parameter	Symbol	Rating	Unit
Collector to Base Voltage	$V_{CB0}$	-20	V
Collector to Emitter Voltage	$V_{CE0}$	-12	V
Emitter to Base Voltage	$V_{EB0}$	-3.0	V
Collector Current	$I_C$	-50	mA
Total Power Dissipation	$P_T$	200	mW
Junction Temperature	$T_j$	150	°C
Storage Temperature	$T_{stg}$	-65 to +150	°C

#### PACKAGE DIMENSIONS

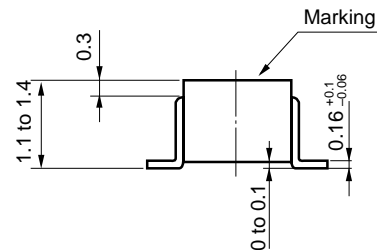
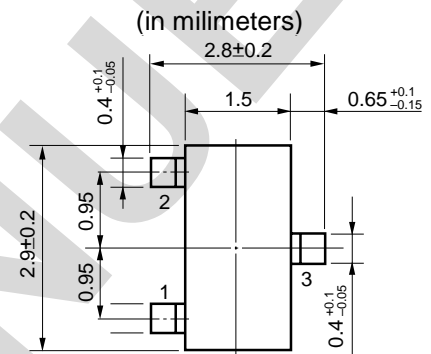

#### PIN CONNECTIONS

- 1: Emitter  
2: Base  
3: Collector    Marking: T93

#### ELECTRICAL CHARACTERISTICS ( $T_A = 25$ °C)

Parameter	Symbol	Test Conditions	MIN.	TYP.	MAX.	Unit
Collector Cutoff Current	$I_{CB0}$	$V_{CB} = -10$ V			-0.1	$\mu$ A
Emitter Cutoff Current	$I_{EB0}$	$V_{EB} = -2$ V			-0.1	$\mu$ A
DC Current Gain	$h_{FE}$	$V_{CE} = -10$ V, $I_C = -15$ mA	20	40	100	
Gain Bandwidth Product	$f_T$	$V_{CE} = -10$ V, $I_C = -15$ mA	4.0	5.5		GHz
Collector Capacitance	$C_{re}^*$	$V_{CB} = -10$ V, $I_E = 0$ , $f = 1$ MHz		0.5	1	pF
Insertion Power Gain	$ S_{21e} ^2$	$V_{CE} = -10$ V, $I_C = -15$ mA, $f = 1.0$ GHz	8.0	10.0		dB
Noise Figure	NF	$V_{CE} = -10$ V, $I_C = -3.0$ mA, $f = 1$ GHz		2.0	3	dB

\* Measured by a 3-terminal bridge. Emitter and Case should be connected to the guard terminal.

#### $h_{FE}$ Classification

Rank	FB
Marking	T93
$h_{FE}$	20 to 100

#### ORDERING INFORMATION

Part Number	Order Number	Quantity
NE97833-T1B 2SA1978-T1B	NE97833-T1B-A 2SA1978-T1B-A	3 kpcs/Reel

**SWITCHING CHARACTERISTICS**

Parameter	Symbol	$V_{in} = 1\text{ V}$	Unit
		TYP	
Turn-on Delay Time	$t_{on} \text{ (delay)}$	1.10	ns
Rise Time	$t_r$	0.77	ns
Turn off Delay Time	$t_{off} \text{ (delay)}$	0.40	ns
Fall Time	$t_f$	0.79	ns

**SWITCHING TIME MEASUREMENT CIRCUIT**

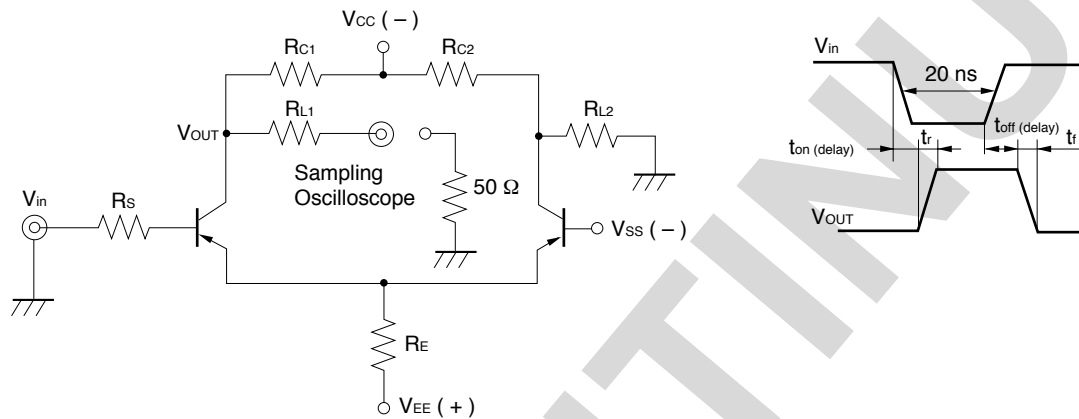

$V_{in} = 1\text{ V}, V_{BB} = -0.5\text{ V}, R_{C1} = R_{C2}$						
$R_s$	$R_C$	$R_{L1}$	$R_{L2}$	$R_E$	$V_{EE}$	$V_{CC}$
( $\Omega$ )	( $\Omega$ )	( $\Omega$ )	( $\Omega$ )	( $\Omega$ )	(V)	(V)
160	1 k	200	250	2.7 k	27	26.3

TYPICAL CHARACTERISTICS

TOTAL POWER DISSIPATION vs. AMBIENT TEMPERATURE

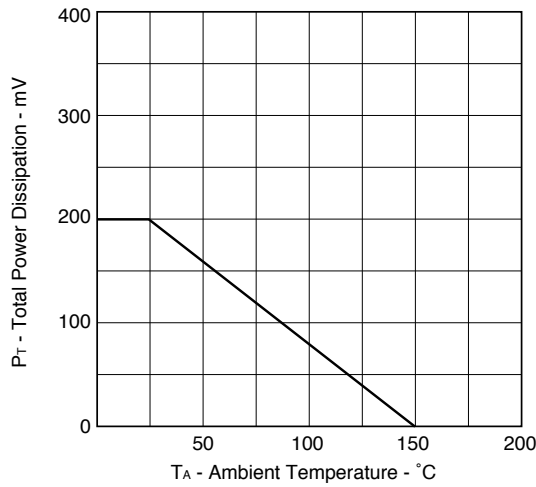

NOISE FIGURE vs. COLLECTOR CURRENT

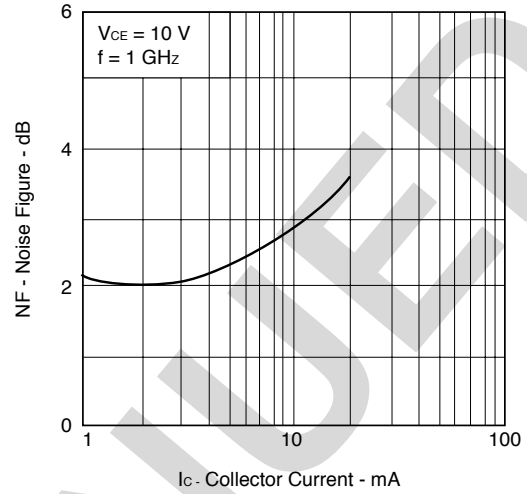

BASE TO EMITTER VOLTAGE vs. COLLECTOR CURRENT

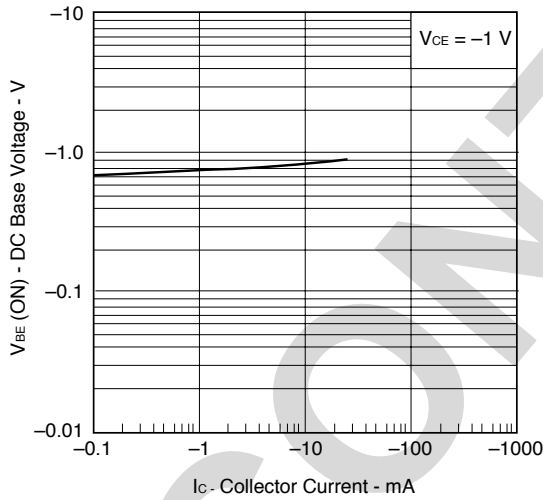

COLLECTOR SATURATION AND BASE TO EMITTER VOLTAGE vs. COLLECTOR CURRENT

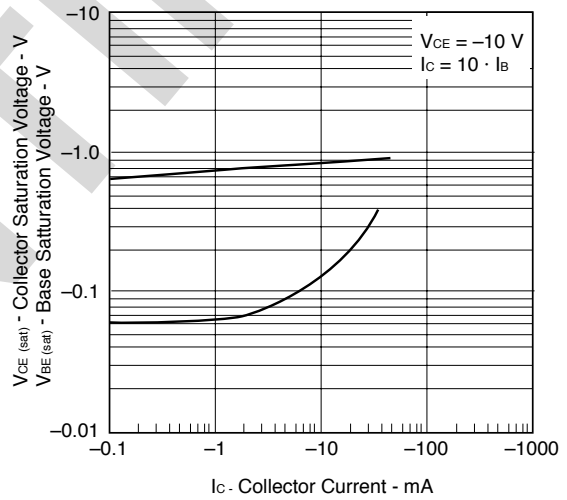

INSERTION GAIN vs. COLLECTOR CURRENT

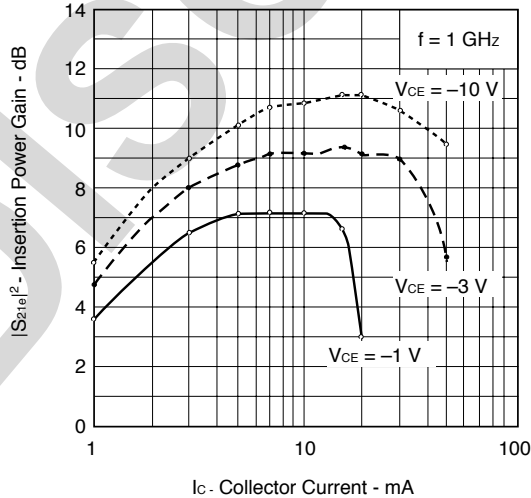

GAIN BANDWIDTH PRODUCT vs. COLLECTOR CURRENT

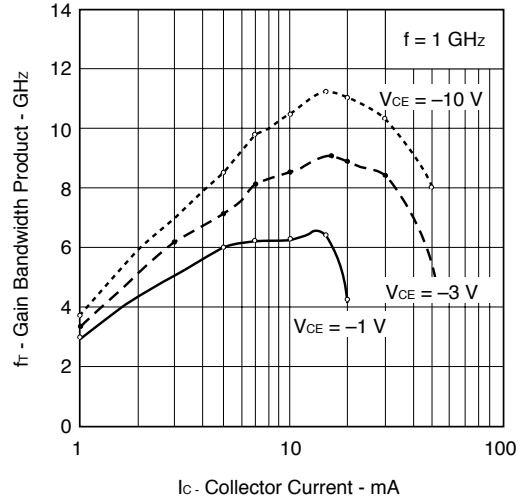

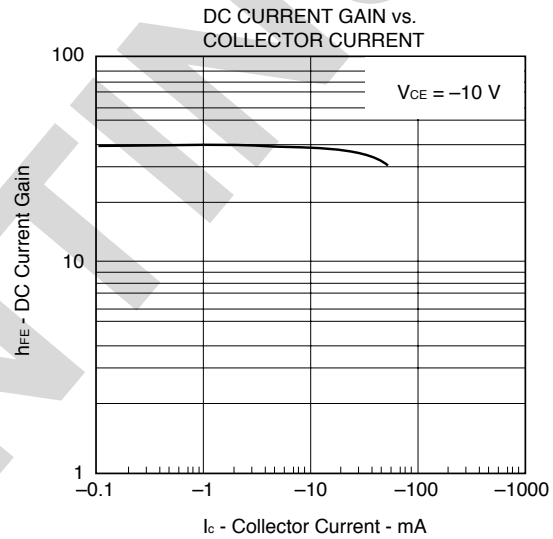
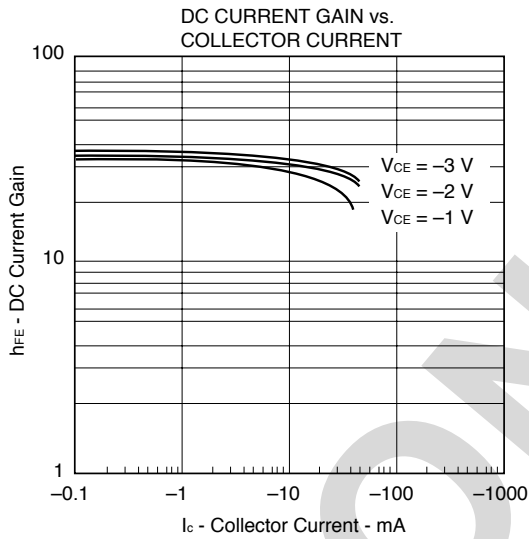
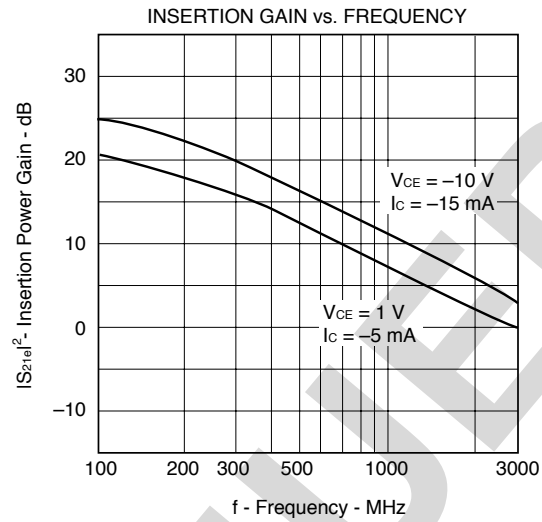
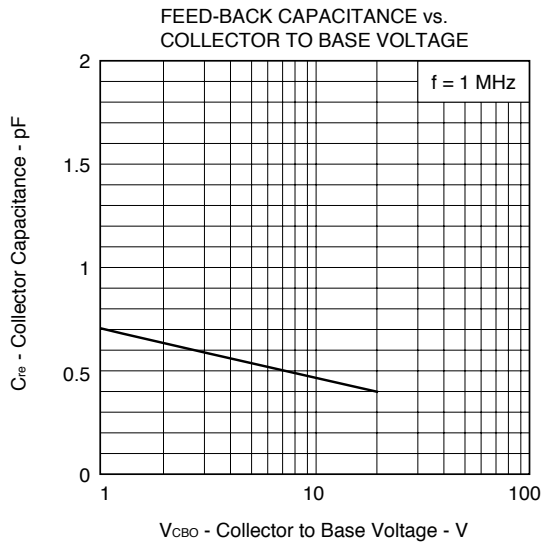

S-PARAMETER

S11

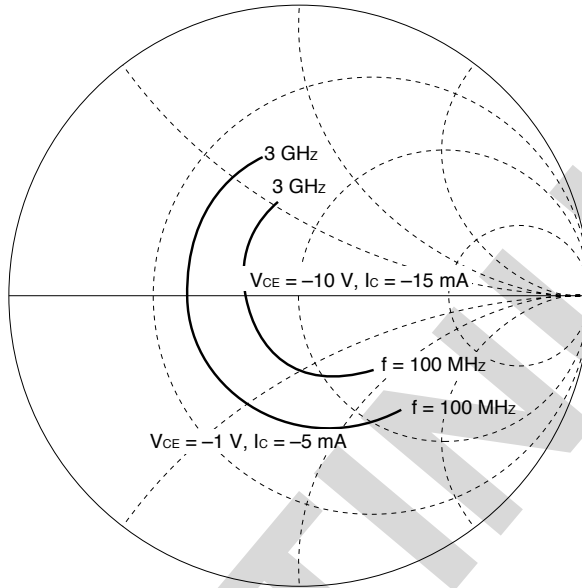

S22

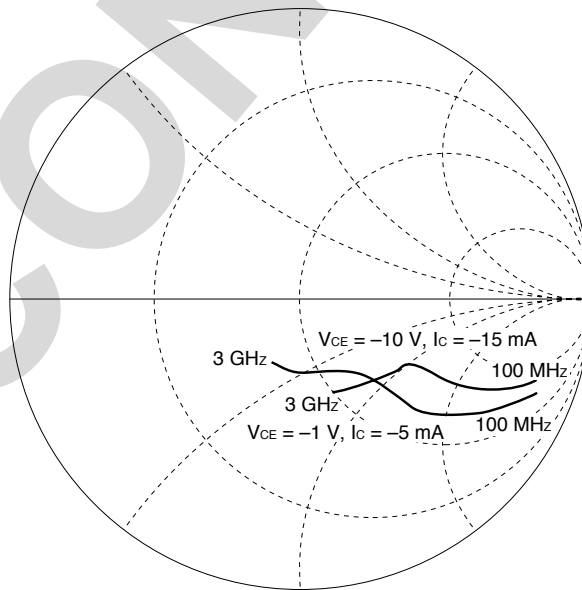

**S-PARAMETER**(V<sub>CE</sub> = 1 V, I<sub>C</sub> = 5 mA, Z<sub>o</sub> = 50 Ω)

f MHz	S <sub>11</sub>		S <sub>21</sub>		S <sub>12</sub>		S <sub>22</sub>	
	MAG	ANG	MAG	ANG	MAG	ANG	MAG	ANG
100	0.527	- 47.1	10.5	149.	0.0359	70.6	0.881	- 21.1
200	0.468	- 83.4	8.37	128.	0.0584	58.7	0.716	- 34.2
300	0.427	- 109	6.63	114.	0.0729	53.6	0.586	- 40.9
400	0.407	- 128	5.36	104.	0.0835	52.1	0.503	- 44.3
500	0.393	- 143	4.46	96.6	0.0930	52.1	0.443	- 45.8
600	0.388	- 154	3.82	90.2	0.100	53.1	0.401	- 46.7
700	0.386	- 164	3.34	84.9	0.109	53.3	0.373	- 47.7
800	0.388	- 172	2.96	80.1	0.118	54.4	0.351	- 49.1
900	0.392	- 179	2.67	75.8	0.128	55.6	0.332	- 50.1
1000	0.394	174	2.43	71.6	0.137	56.4	0.319	- 51.4
1100	0.399	169	2.24	68.1	0.147	56.9	0.306	- 53.2
1200	0.405	163	2.07	64.6	0.158	57.2	0.298	- 54.5
1300	0.410	159	1.93	61.3	0.168	57.6	0.289	- 57.0
1400	0.416	154	1.81	58.0	0.179	57.7	0.280	- 59.3
1500	0.422	150	1.71	54.9	0.190	57.7	0.274	- 61.2
1600	0.431	147	1.62	52.0	0.201	57.7	0.267	- 64.4
1700	0.438	143	1.54	49.3	0.213	57.5	0.262	- 66.7
1800	0.445	140	1.47	46.6	0.224	57.2	0.259	- 70.3
1900	0.451	136	1.41	44.1	0.236	56.8	0.252	- 73.6
2000	0.460	133	1.35	41.5	0.248	56.3	0.247	- 76.3
2100	0.465	130	1.30	39.2	0.261	55.7	0.243	- 80.2
2200	0.473	127	1.26	36.9	0.273	55.1	0.239	- 84.4
2300	0.481	125	1.21	34.8	0.286	54.3	0.234	- 87.2
2400	0.487	122	1.17	32.5	0.299	53.3	0.235	- 91.9
2500	0.493	119	1.14	30.6	0.312	52.6	0.230	- 95.9

**S-PARAMETER**(V<sub>CE</sub> = 3 V, I<sub>C</sub> = 5 mA, Z<sub>o</sub> = 50 Ω)

f MHz	S <sub>11</sub>		S <sub>21</sub>		S <sub>12</sub>		S <sub>22</sub>	
	MAG	ANG	MAG	ANG	MAG	ANG	MAG	ANG
100	0.558	- 37.1	11.0	153.	0.0288	74.3	915	- 16.3
200	0.485	- 67.9	9.13	133.	0.0467	83.0	784	- 27.0
300	0.423	- 92.5	7.48	119.	0.0611	58.1	670	- 33.0
400	0.381	- 111	6.21	109.	0.0703	56.5	590	- 36.0
500	0.353	- 127	5.18	101.	0.0801	56.1	531	- 37.4
600	0.339	- 140	4.47	95.1	0.0880	56.7	490	- 38.1
700	0.329	- 151	3.92	89.9	0.0938	57.5	461	- 33.8
800	0.325	- 160	3.48	84.9	0.104	57.9	438	- 39.8
900	0.325	- 169	3.14	80.7	0.113	58.7	419	- 40.4
1000	0.326	- 176	2.87	76.9	0.122	59.5	408	- 41.6
1100	0.330	177	2.64	73.0	0.131	60.5	393	- 42.8
1200	0.335	170	2.44	69.6	0.140	61.2	386	- 44.0
1300	0.339	165	2.28	66.5	0.150	61.3	377	- 45.9
1400	0.345	160	2.13	63.3	0.160	61.9	366	- 47.5
1500	0.351	155	2.01	60.2	0.170	61.9	362	- 49.0
1600	0.360	151	1.90	57.4	0.181	61.8	354	- 51.0
1700	0.366	147	1.81	54.6	0.191	61.8	349	- 53.0
1800	0.374	143	1.72	52.0	0.202	61.7	344	- 55.5
1900	0.382	140	1.65	49.5	0.213	61.3	337	- 58.1
2000	0.390	137	1.58	47.0	0.223	61.0	334	- 60.4
2100	0.396	133	1.52	44.6	0.233	60.4	328	- 63.0
2200	0.404	130	1.46	42.4	0.243	60.2	321	- 65.9
2300	0.413	127	1.41	40.2	0.251	59.4	318	- 68.3
2400	0.418	125	1.36	38.0	0.273	58.9	314	- 72.1
2500	0.427	122	1.32	35.9	0.255	58.2	303	- 74.8

**S-PARAMETER**(V<sub>CE</sub> = 10 V, I<sub>C</sub> = 5 mA, Z<sub>o</sub> = 50 Ω)

f MHz	S <sub>11</sub>		S <sub>21</sub>		S <sub>12</sub>		S <sub>22</sub>	
	MAG	ANG	MAG	ANG	MAG	ANG	MAG	ANG
100	0.529	-28.8	11.3	156.	0.0234	75.4	0.939	-12.8
200	0.548	-53.5	9.70	138.	0.0412	67.4	0.836	-21.7
300	0.463	-73.9	8.20	124.	0.0530	62.1	0.739	-27.2
400	0.400	-91.4	6.94	114.	0.0620	59.7	0.666	-29.9
500	0.349	-106	5.86	106.	0.0712	58.9	0.608	-31.4
600	0.316	-119	5.09	100.	0.0793	59.8	0.567	-31.9
700	0.292	-131	4.49	94.6	0.0860	59.6	0.539	-32.7
800	0.277	-141	4.00	89.7	0.0938	60.4	0.516	-33.5
900	0.267	-152	3.63	85.4	0.101	61.3	0.498	-34.2
1000	0.261	-160	3.31	81.5	0.109	61.9	0.485	-35.1
1100	0.259	-169	3.04	77.9	0.117	62.8	0.472	-35.9
1200	0.260	-177	2.82	74.5	0.125	63.2	0.463	-36.9
1300	0.263	176	2.63	71.3	0.133	63.9	0.455	-38.4
1400	0.267	169	2.46	68.2	0.143	64.4	0.448	-39.5
1500	0.272	164	2.32	65.3	0.152	64.5	0.440	-40.8
1600	0.280	159	2.20	62.5	0.161	64.6	0.434	-42.5
1700	0.286	154	2.09	59.8	0.171	64.9	0.428	-44.1
1800	0.293	149	1.99	57.3	0.191	64.8	0.423	-46.0
1900	0.300	145	1.90	54.8	0.192	64.4	0.417	-47.8
2000	0.308	141	1.82	52.3	0.201	64.5	0.413	-49.7
2100	0.315	138	1.75	49.9	0.212	63.9	0.408	-51.9
2200	0.325	134	1.68	47.6	0.223	63.8	0.402	-54.3
2300	0.333	131	1.63	45.5	0.235	63.2	0.397	-56.1
2400	0.341	128	1.57	43.3	0.246	62.7	0.395	-58.7
2500	0.348	125	1.52	41.2	0.258	62.1	0.388	-61.0

**S-PARAMETER**(V<sub>CE</sub> = 10 V, I<sub>C</sub> = 15 mA, Z<sub>o</sub> = 50 Ω)

f MHz	S <sub>11</sub>		S <sub>21</sub>		S <sub>12</sub>		S <sub>22</sub>	
	MAG	ANG	MAG	ANG	MAG	ANG	MAG	ANG
100	0.354	- 46.6	17.87	147.	0.0190	74.6	866	- 18.3
200	0.290	- 81.8	13.45	125.	0.0317	70.0	708	- 26.9
300	0.247	- 107	10.35	113.	0.0420	68.4	601	- 29.8
400	0.226	- 126	8.294	104.	0.0518	68.3	539	- 30.5
500	0.215	- 141	6.799	97.8	0.0626	69.8	497	- 30.2
600	0.210	- 154	5.805	92.4	0.0720	70.8	470	- 30.1
700	0.208	- 164	5.050	88.1	0.0820	71.0	450	- 30.2
800	0.211	- 172	4.475	84.1	0.0919	70.9	435	- 30.6
900	0.215	179	4.008	80.5	0.102	70.9	423	- 31.1
1000	0.218	172	3.647	77.2	0.112	70.7	415	- 32.2
1100	0.225	166	3.345	74.2	0.121	70.9	405	- 32.9
1200	0.232	160	3.086	71.1	0.133	70.3	400	- 34.2
1300	0.237	156	2.871	68.4	0.143	70.2	394	- 35.7
1400	0.244	151	2.685	65.7	0.153	69.7	386	- 36.8
1500	0.251	147	2.532	63.2	0.165	69.2	381	- 38.4
1600	0.261	143	2.392	60.5	0.174	68.7	376	- 39.9
1700	0.268	140	2.265	58.2	0.185	68.0	373	- 41.6
1800	0.276	137	2.155	55.7	0.196	67.3	366	- 43.7
1900	0.284	134	2.059	53.5	0.207	66.5	360	- 45.7
2000	0.292	131	1.974	51.1	0.219	65.8	356	- 47.5
2100	0.299	128	1.897	49.0	0.230	65.1	350	- 49.7
2200	0.308	125	1.826	46.9	0.242	64.2	345	- 51.8
2300	0.317	123	1.763	44.7	0.252	63.3	341	- 53.8
2400	0.324	121	1.697	42.7	0.264	62.4	337	- 56.7
2500	0.332	119	1.646	40.7	0.276	61.5	331	- 58.8

## NOTICE

1. Descriptions of circuits, software and other related information in this document are provided only to illustrate the operation of semiconductor products and application examples. You are fully responsible for the incorporation of these circuits, software, and information in the design of your equipment. California Eastern Laboratories and Renesas Electronics assumes no responsibility for any losses incurred by you or third parties arising from the use of these circuits, software, or information.
2. California Eastern Laboratories has used reasonable care in preparing the information included in this document, but California Eastern Laboratories does not warrant that such information is error free. California Eastern Laboratories and Renesas Electronics assumes no liability whatsoever for any damages incurred by you resulting from errors in or omissions from the information included herein.
3. California Eastern Laboratories and Renesas Electronics do not assume any liability for infringement of patents, copyrights, or other intellectual property rights of third parties by or arising from the use of Renesas Electronics products or technical information described in this document. No license, express, implied or otherwise, is granted hereby under any patents, copyrights or other intellectual property rights of California Eastern Laboratories or Renesas Electronics or others.
4. You should not alter, modify, copy, or otherwise misappropriate any Renesas Electronics product, whether in whole or in part. California Eastern Laboratories and Renesas Electronics assume no responsibility for any losses incurred by you or third parties arising from such alteration, modification, copy or otherwise misappropriation of Renesas Electronics product.
5. Renesas Electronics products are classified according to the following two quality grades: "Standard" and "High Quality". The recommended applications for each Renesas Electronics product depends on the product's quality grade, as indicated below. "Standard": Computers; office equipment; communications equipment; test and measurement equipment; audio and visual equipment; home electronic appliances; machine tools; personal electronic equipment; and industrial robots etc. "High Quality": Transportation equipment (automobiles, trains, ships, etc.); traffic control systems; anti-disaster systems; anti-crime systems; and safety equipment etc. Renesas Electronics products are neither intended nor authorized for use in products or systems that may pose a direct threat to human life or bodily injury (artificial life support devices or systems, surgical implantations etc.), or may cause serious property damages (nuclear reactor control systems, military equipment etc.). You must check the quality grade of each Renesas Electronics product before using it in a particular application. You may not use any Renesas Electronics product for any application for which it is not intended. California Eastern Laboratories and Renesas Electronics shall not be in any way liable for any damages or losses incurred by you or third parties arising from the use of any Renesas Electronics product for which the product is not intended by California Eastern Laboratories or Renesas Electronics.
6. You should use the Renesas Electronics products described in this document within the range specified by California Eastern Laboratories, especially with respect to the maximum rating, operating supply voltage range, movement power voltage range, heat radiation characteristics, installation and other product characteristics. California Eastern Laboratories shall have no liability for malfunctions or damages arising out of the use of Renesas Electronics products beyond such specified ranges.
7. Although Renesas Electronics endeavors to improve the quality and reliability of its products, semiconductor products have specific characteristics such as the occurrence of failure at a certain rate and malfunctions under certain use conditions. Further, Renesas Electronics products are not subject to radiation resistance design. Please be sure to implement safety measures to guard them against the possibility of physical injury, and injury or damage caused by fire in the event of the failure of a Renesas Electronics product, such as safety design for hardware and software including but not limited to redundancy, fire control and malfunction prevention, appropriate treatment for aging degradation or any other appropriate measures. Because the evaluation of microcomputer software alone is very difficult, please evaluate the safety of the final products or systems manufactured by you.
8. Please contact a California Eastern Laboratories sales office for details as to environmental matters such as the environmental compatibility of each Renesas Electronics product. Please use Renesas Electronics products in compliance with all applicable laws and regulations that regulate the inclusion or use of controlled substances, including without limitation, the EU RoHS Directive. California Eastern Laboratories and Renesas Electronics assume no liability for damages or losses occurring as a result of your noncompliance with applicable laws and regulations.
9. Renesas Electronics products and technology may not be used for or incorporated into any products or systems whose manufacture, use, or sale is prohibited under any applicable domestic or foreign laws or regulations. You should not use Renesas Electronics products or technology described in this document for any purpose relating to military applications or use by the military, including but not limited to the development of weapons of mass destruction. When exporting the Renesas Electronics products or technology described in this document, you should comply with the applicable export control laws and regulations and follow the procedures required by such laws and regulations.
10. It is the responsibility of the buyer or distributor of California Eastern Laboratories, who distributes, disposes of, or otherwise places the Renesas Electronics product with a third party, to notify such third party in advance of the contents and conditions set forth in this document, California Eastern Laboratories and Renesas Electronics assume no responsibility for any losses incurred by you or third parties as a result of unauthorized use of Renesas Electronics products.
11. This document may not be reproduced or duplicated in any form, in whole or in part, without prior written consent of California Eastern Laboratories.
12. Please contact a California Eastern Laboratories sales office if you have any questions regarding the information contained in this document or Renesas Electronics products, or if you have any other inquiries.

**NOTE 1:** "Renesas Electronics" as used in this document means Renesas Electronics Corporation and also includes its majority-owned subsidiaries.

**NOTE 2:** "Renesas Electronics product(s)" means any product developed or manufactured by or for Renesas Electronics.

**NOTE 3:** Products and product information are subject to change without notice.

**CEL Headquarters** • 4590 Patrick Henry Drive, Santa Clara, CA 95054 • Phone (408) 919-2500 • [www.cel.com](http://www.cel.com)

For a complete list of sales offices, representatives and distributors,  
Please visit our website: [www.cel.com/contactus](http://www.cel.com/contactus)

## Looking for pricing, stock, or lifecycle information?

Click below to explore more details on WIN SOURCE:

 [View 2SA1978-T1B on WIN SOURCE](#)

 [CEL Information](#)

## Optimize Your Supply Chain with WIN SOURCE Solutions

-  Global Sourcing Solution
-  Obsolete Management
-  Cost Control Management
-  Shortage Management
-  Alternative Solution
-  Excess Inventory Management