



# THE DATASHEET OF LM1117IDT-3.3



## LM1117 800-mA Low-Dropout Linear Regulator

### 1 Features

- Available in 1.8 V, 2.5 V, 3.3 V, 5 V, and Adjustable Versions
- Space-Saving SOT-223 and WSON Packages
- Current Limiting and Thermal Protection
- Output Current 800 mA
- Line Regulation 0.2% (Maximum)
- Load Regulation 0.4% (Maximum)
- Temperature Range
  - LM1117: 0°C to 125°C
  - LM1117I: –40°C to 125°C

### 2 Applications

- Post Regulator for Switching DC–DC Converter
- High Efficiency Linear Regulators
- Battery Chargers
- Portable Instrumentation
- Active SCSI Termination Regulator

### 3 Description

The LM1117 is a low dropout voltage regulator with a dropout of 1.2 V at 800 mA of load current.

The LM1117 is available in an adjustable version, which can set the output voltage from 1.25 to 13.8 V with only two external resistors. In addition, it is available in five fixed voltages, 1.8 V, 2.5 V, 3.3 V, and 5 V.

The LM1117 offers current limiting and thermal shutdown. Its circuit includes a Zener trimmed bandgap reference to assure output voltage accuracy to within  $\pm 1\%$ .

A minimum of 10- $\mu$ F tantalum capacitor is required at the output to improve the transient response and stability.

#### Device Information<sup>(1)</sup>

PART NUMBER	PACKAGE	BODY SIZE (NOM)
LM1117, LM1117I	SOT-223 (4)	6.50 mm x 3.50 mm
	TO-220 (3)	14.986 mm x 10.16 mm
	TO-252 (3)	6.58 mm x 6.10 mm
	WSON (8)	4.00 mm x 4.00 mm
	TO-263 (3)	10.18 mm x 8.41 mm

(1) For all available packages, see the orderable addendum at the end of the data sheet.

#### Adjustable Output Regulator



\*  $C_{Adj}$  is optional, however it will improve ripple rejection.



## Table of Contents

<b>1 Features</b> .....	<b>1</b>	7.3 Feature Description .....	<b>11</b>
<b>2 Applications</b> .....	<b>1</b>	7.4 Device Functional Modes .....	<b>12</b>
<b>3 Description</b> .....	<b>1</b>	<b>8 Application and Implementation</b> .....	<b>14</b>
<b>4 Revision History</b> .....	<b>2</b>	8.1 Application Information .....	<b>14</b>
<b>5 Pin Configuration and Functions</b> .....	<b>3</b>	8.2 Typical Application .....	<b>14</b>
<b>6 Specifications</b> .....	<b>4</b>	8.3 System Examples .....	<b>16</b>
6.1 Absolute Maximum Ratings .....	<b>4</b>	<b>9 Power Supply Recommendations</b> .....	<b>17</b>
6.2 ESD Ratings .....	<b>4</b>	<b>10 Layout</b> .....	<b>17</b>
6.3 Recommended Operating Conditions .....	<b>4</b>	10.1 Layout Guidelines .....	<b>17</b>
6.4 Thermal Information .....	<b>4</b>	10.2 Layout Example .....	<b>21</b>
6.5 LM1117 Electrical Characteristics .....	<b>5</b>	<b>11 Device and Documentation Support</b> .....	<b>22</b>
6.6 LM1117I Electrical Characteristics .....	<b>7</b>	11.1 Community Resources .....	<b>22</b>
6.7 Typical Characteristics .....	<b>9</b>	11.2 Trademarks .....	<b>22</b>
<b>7 Detailed Description</b> .....	<b>11</b>	11.3 Electrostatic Discharge Caution .....	<b>22</b>
7.1 Overview .....	<b>11</b>	11.4 Glossary .....	<b>22</b>
7.2 Functional Block Diagram .....	<b>11</b>	<b>12 Mechanical, Packaging, and Orderable Information</b> .....	<b>22</b>

## 4 Revision History

NOTE: Page numbers for previous revisions may differ from page numbers in the current version.

<b>Changes from Revision M (March 2013) to Revision N</b>	<b>Page</b>
• Added <i>Pin Configuration and Functions</i> section, <i>ESD Ratings</i> table, <i>Feature Description</i> section, <i>Device Functional Modes</i> , <i>Application and Implementation</i> section, <i>Power Supply Recommendations</i> section, <i>Layout</i> section, <i>Device and Documentation Support</i> section, and <i>Mechanical, Packaging, and Orderable Information</i> section .....	<b>1</b>
• Removed LM1117-N-2.85 option after part became inactive .....	<b>1</b>
• Removed TO-263 Pinout Side View image .....	<b>3</b>

<b>Changes from Revision L (July 2012) to Revision M</b>	<b>Page</b>
• Changed layout of National Data Sheet to TI format .....	<b>16</b>

## 5 Pin Configuration and Functions

**DCY Package  
4-Pin SOT  
Top View**

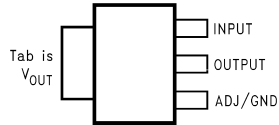

**KTT Package  
3-Pin TO-263  
Top View**

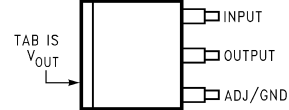

**NDE Package  
3-Pin TO-220  
Top View**

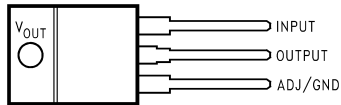

**NDP Package  
3-Pin TO-252  
Top View**

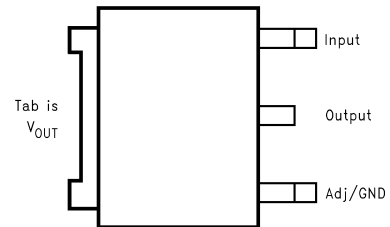

**NGN Package  
8-Pin WSON  
Top View**

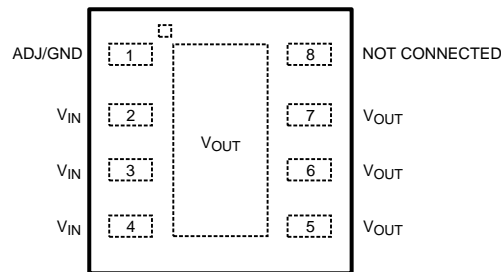

When using the WSON package  
Pins 2, 3 and 4 must be connected together and  
Pins 5, 6 and 7 must be connected together

### Pin Functions

NAME	PIN					I/O	DESCRIPTION
	TO-252	WSON	SOT-223	TO-263	TO-220		
ADJ/GND	1	1	1	1	1	—	Adjust pin for adjustable output option. Ground pin for fixed output option.
$V_{IN}$	3	2, 3, 4	3	3	3	I	Input voltage pin for the regulator
$V_{OUT}$	2, TAB	5, 6, 7, TAB	2, 4	2, TAB	2, TAB	O	Output voltage pin for the regulator

## 6 Specifications

### 6.1 Absolute Maximum Ratings

 over operating free-air temperature range (unless otherwise noted)<sup>(1)</sup>

		MIN	MAX	UNIT
Maximum Input Voltage ( $V_{IN}$ to GND)			20	V
Power Dissipation <sup>(2)</sup>		Internally Limited		
Junction Temperature ( $T_J$ ) <sup>(2)</sup>			150	°C
Lead Temperature	TO-220 (T) Package, 10 s		260	°C
	SOT-223 (MP) Package, 4 s		260	
Storage Temperature, $T_{stg}$		-65	150	°C

- (1) Stresses beyond those listed under *Absolute Maximum Ratings* may cause permanent damage to the device. These are stress ratings only, which do not imply functional operation of the device at these or any other conditions beyond those indicated under *Recommended Operating Conditions*. Exposure to absolute-maximum-rated conditions for extended periods may affect device reliability.
- (2) The maximum power dissipation is a function of  $T_{J(max)}$ ,  $R_{\theta JA}$ , and  $T_A$ . The maximum allowable power dissipation at any ambient temperature is  $P_D = (T_{J(max)} - T_A) / R_{\theta JA}$ . All numbers apply for packages soldered directly into a PCB.

### 6.2 ESD Ratings

			VALUE	UNIT
$V_{(ESD)}$	Electrostatic discharge	Human-body model (HBM), per ANSI/ESDA/JEDEC JS-001 <sup>(1)</sup>	±2000	V

- (1) JEDEC document JEP155 states that 500-V HBM allows safe manufacturing with a standard ESD control process. Pins listed as ±2000 V may actually have higher performance.

### 6.3 Recommended Operating Conditions

over operating free-air temperature range (unless otherwise noted)

		MIN	MAX	UNIT
Input Voltage ( $V_{IN}$ to GND)			15	V
Junction Temperature ( $T_J$ ) <sup>(1)</sup>	LM1117	0	125	°C
	LM1117I	-40	125	

- (1) The maximum power dissipation is a function of  $T_{J(max)}$ ,  $R_{\theta JA}$ , and  $T_A$ . The maximum allowable power dissipation at any ambient temperature is  $P_D = (T_{J(max)} - T_A) / R_{\theta JA}$ . All numbers apply for packages soldered directly into a PCB.

### 6.4 Thermal Information

THERMAL METRIC <sup>(1)</sup>		LM1117, LM1117I					UNIT
		DCY (SOT-223)	NDE (TO-220)	NDP (TO-252)	NGN (WSON)	KTT (TO-263)	
		4 PINS	3 PINS	3 PINS	8 PINS	3 PINS	
$R_{\theta JA}$	Junction-to-ambient thermal resistance	61.6	23.8	45.1	39.3	41.3	°C/W
$R_{\theta JC(top)}$	Junction-to-case (top) thermal resistance	42.5	16.6	52.1	31.4	44.1	°C/W
$R_{\theta JB}$	Junction-to-board thermal resistance	10.4	5.3	29.8	16.5	24.2	°C/W
$\Psi_{JT}$	Junction-to-top characterization parameter	2.9	3.1	4.5	0.3	10.9	°C/W
$\Psi_{JB}$	Junction-to-board characterization parameter	10.3	5.3	29.4	16.7	23.2	°C/W
$R_{\theta JC(bot)}$	Junction-to-case (bottom) thermal resistance	—	1.5	1.3	5.6	1.3	°C/W

- (1) For more information about traditional and new thermal metrics, see the *Semiconductor and IC Package Thermal Metrics* application report, [SPRA953](http://SPRA953).

## 6.5 LM1117 Electrical Characteristics

 unless otherwise specified,  $T_J = 25^\circ\text{C}$ .

PARAMETER		TEST CONDITIONS	MIN <sup>(1)</sup>	TYP <sup>(2)</sup>	MAX <sup>(1)</sup>	UNIT		
$V_{REF}$	Reference Voltage	LM1117-ADJ $I_{OUT} = 10\text{ mA}$ , $V_{IN} - V_{OUT} = 2\text{ V}$ , $T_J = 25^\circ\text{C}$	1.238	1.25	1.262	V		
		LM1117-ADJ $10\text{ mA} \leq I_{OUT} \leq 800\text{ mA}$ , $1.4\text{ V} \leq V_{IN} - V_{OUT} \leq 10\text{ V}$	$T_J = 25^\circ\text{C}$ over the junction temperature range $0^\circ\text{C}$ to $125^\circ\text{C}$		1.25		1.27	
$V_{OUT}$	Output Voltage	LM1117-1.8 $I_{OUT} = 10\text{ mA}$ , $V_{IN} = 3.8\text{ V}$ , $T_J = 25^\circ\text{C}$	1.782	1.8	1.818	V		
		LM1117-1.8 $0 \leq I_{OUT} \leq 800\text{ mA}$ , $3.2\text{ V} \leq V_{IN} \leq 10\text{ V}$	$T_J = 25^\circ\text{C}$ over the junction temperature range $0^\circ\text{C}$ to $125^\circ\text{C}$		1.746		1.854	
		LM1117-2.5 $I_{OUT} = 10\text{ mA}$ , $V_{IN} = 4.5\text{ V}$ , $T_J = 25^\circ\text{C}$	2.475	2.5	2.525	V		
		LM1117-2.5 $0 \leq I_{OUT} \leq 800\text{ mA}$ , $3.9\text{ V} \leq V_{IN} \leq 10\text{ V}$	$T_J = 25^\circ\text{C}$ over the junction temperature range $0^\circ\text{C}$ to $125^\circ\text{C}$		2.45		2.55	
		LM1117-3.3 $I_{OUT} = 10\text{ mA}$ , $V_{IN} = 5\text{ V}$ , $T_J = 25^\circ\text{C}$	3.267	3.3	3.333	V		
		LM1117-3.3 $0 \leq I_{OUT} \leq 800\text{ mA}$ , $4.75\text{ V} \leq V_{IN} \leq 10\text{ V}$	$T_J = 25^\circ\text{C}$ over the junction temperature range $0^\circ\text{C}$ to $125^\circ\text{C}$		3.235		3.365	
		LM1117-5.0 $I_{OUT} = 10\text{ mA}$ , $V_{IN} = 7\text{ V}$ , $T_J = 25^\circ\text{C}$	4.95	5	5.05	V		
		LM1117-5.0 $0 \leq I_{OUT} \leq 800\text{ mA}$ , $6.5\text{ V} \leq V_{IN} \leq 12\text{ V}$	$T_J = 25^\circ\text{C}$ over the junction temperature range $0^\circ\text{C}$ to $125^\circ\text{C}$		4.9		5.1	
		$\Delta V_{OUT}$	Line Regulation <sup>(3)</sup>	LM1117-ADJ $I_{OUT} = 10\text{ mA}$ , $1.5\text{ V} \leq V_{IN} - V_{OUT} \leq 13.75\text{ V}$	$T_J = 25^\circ\text{C}$ over the junction temperature range $0^\circ\text{C}$ to $125^\circ\text{C}$		0.035%	0.2%
				LM1117-1.8 $I_{OUT} = 0\text{ mA}$ , $3.2\text{ V} \leq V_{IN} \leq 10\text{ V}$	$T_J = 25^\circ\text{C}$ over the junction temperature range $0^\circ\text{C}$ to $125^\circ\text{C}$		1	6
LM1117-2.5 $I_{OUT} = 0\text{ mA}$ , $3.9\text{ V} \leq V_{IN} \leq 10\text{ V}$	$T_J = 25^\circ\text{C}$ over the junction temperature range $0^\circ\text{C}$ to $125^\circ\text{C}$			1	6			
LM1117-3.3 $I_{OUT} = 0\text{ mA}$ , $4.75\text{ V} \leq V_{IN} \leq 15\text{ V}$	$T_J = 25^\circ\text{C}$ over the junction temperature range $0^\circ\text{C}$ to $125^\circ\text{C}$			1	6			
LM1117-5.0 $I_{OUT} = 0\text{ mA}$ , $6.5\text{ V} \leq V_{IN} \leq 15\text{ V}$	$T_J = 25^\circ\text{C}$ over the junction temperature range $0^\circ\text{C}$ to $125^\circ\text{C}$			1	10			
$\Delta V_{OUT}$	Load Regulation <sup>(3)</sup>	LM1117-ADJ $V_{IN} - V_{OUT} = 3\text{ V}$ , $10 \leq I_{OUT} \leq 800\text{ mA}$	$T_J = 25^\circ\text{C}$ over the junction temperature range $0^\circ\text{C}$ to $125^\circ\text{C}$		0.2%	0.4%		
		LM1117-1.8 $V_{IN} = 3.2\text{ V}$ , $0 \leq I_{OUT} \leq 800\text{ mA}$	$T_J = 25^\circ\text{C}$ over the junction temperature range $0^\circ\text{C}$ to $125^\circ\text{C}$		1	10		
		LM1117-2.5 $V_{IN} = 3.9\text{ V}$ , $0 \leq I_{OUT} \leq 800\text{ mA}$	$T_J = 25^\circ\text{C}$ over the junction temperature range $0^\circ\text{C}$ to $125^\circ\text{C}$		1	10		
		LM1117-3.3 $V_{IN} = 4.75\text{ V}$ , $0 \leq I_{OUT} \leq 800\text{ mA}$	$T_J = 25^\circ\text{C}$ over the junction temperature range $0^\circ\text{C}$ to $125^\circ\text{C}$		1	10		
		LM1117-5.0 $V_{IN} = 6.5\text{ V}$ , $0 \leq I_{OUT} \leq 800\text{ mA}$	$T_J = 25^\circ\text{C}$ over the junction temperature range $0^\circ\text{C}$ to $125^\circ\text{C}$		1	15		

(1) All limits are ensured by testing or statistical analysis.

(2) Typical Values represent the most likely parametric normal.

(3) Load and line regulation are measured at constant junction room temperature.

**LM1117 Electrical Characteristics (continued)**

 unless otherwise specified,  $T_J = 25^\circ\text{C}$ .

PARAMETER	TEST CONDITIONS		MIN <sup>(1)</sup>	TYP <sup>(2)</sup>	MAX <sup>(1)</sup>	UNIT
$V_{IN} - V_{OUT}$ Dropout Voltage <sup>(4)</sup>	$I_{OUT} = 100\text{ mA}$	$T_J = 25^\circ\text{C}$		1.1		V
		over the junction temperature range $0^\circ\text{C}$ to $125^\circ\text{C}$			1.2	
	$I_{OUT} = 500\text{ mA}$	$T_J = 25^\circ\text{C}$		1.15		V
		over the junction temperature range $0^\circ\text{C}$ to $125^\circ\text{C}$			1.25	
	$I_{OUT} = 800\text{ mA}$	$T_J = 25^\circ\text{C}$		1.2		V
		over the junction temperature range $0^\circ\text{C}$ to $125^\circ\text{C}$			1.3	
$I_{LIMIT}$ Current Limit	$V_{IN} - V_{OUT} = 5\text{ V}$ , $T_J = 25^\circ\text{C}$		800	1200	1500	mA
Minimum Load Current <sup>(5)</sup>	LM1117-ADJ $V_{IN} = 15\text{ V}$	$T_J = 25^\circ\text{C}$		1.7		mA
		over the junction temperature range $0^\circ\text{C}$ to $125^\circ\text{C}$			5	
Quiescent Current	LM1117-1.8 $V_{IN} \leq 15\text{ V}$	$T_J = 25^\circ\text{C}$		5		mA
		over the junction temperature range $0^\circ\text{C}$ to $125^\circ\text{C}$			10	
	LM1117-2.5 $V_{IN} \leq 15\text{ V}$	$T_J = 25^\circ\text{C}$		5		mA
		over the junction temperature range $0^\circ\text{C}$ to $125^\circ\text{C}$			10	
	LM1117-3.3 $V_{IN} \leq 15\text{ V}$	$T_J = 25^\circ\text{C}$		5		mA
		over the junction temperature range $0^\circ\text{C}$ to $125^\circ\text{C}$			10	
	LM1117-5.0 $V_{IN} \leq 15\text{ V}$	$T_J = 25^\circ\text{C}$		5		mA
		over the junction temperature range $0^\circ\text{C}$ to $125^\circ\text{C}$			10	
Thermal Regulation	$T_A = 25^\circ\text{C}$ , 30-ms pulse			0.01	0.1	%/W
Ripple Regulation	$f_{RIPPLE} = 1\text{ 20 Hz}$ , $V_{IN} - V_{OUT} = 3\text{ V}$ $V_{RIPPLE} = 1\text{ V}_{PP}$	$T_J = 25^\circ\text{C}$		75		dB
		over the junction temperature range $0^\circ\text{C}$ to $125^\circ\text{C}$		60		
Adjust Pin Current	$T_J = 25^\circ\text{C}$			60		$\mu\text{A}$
	over the junction temperature range $0^\circ\text{C}$ to $125^\circ\text{C}$				120	
Adjust Pin Current Change	$10 \leq I_{OUT} \leq 80\text{ mA}$ , $1.4\text{ V} \leq V_{IN} - V_{OUT} \leq 10\text{ V}$	$T_J = 25^\circ\text{C}$		0.2		$\mu\text{A}$
		over the junction temperature range $0^\circ\text{C}$ to $125^\circ\text{C}$			5	
Temperature Stability				0.5%		
Long Term Stability	$T_A = 125^\circ\text{C}$ , 1000 Hrs			0.3%		
RMS Output Noise	(% of $V_{OUT}$ ), $10\text{ Hz} \leq f \leq 10\text{ kHz}$			0.003%		

(4) The dropout voltage is the input/output differential at which the circuit ceases to regulate against further reduction in input voltage. It is measured when the output voltage has dropped 100 mV from the nominal value obtained at  $V_{IN} = V_{OUT} + 1.5\text{ V}$ .

(5) The minimum output current required to maintain regulation.

## 6.6 LM1117I Electrical Characteristics

unless otherwise specified,  $T_J = 25^\circ\text{C}$ .

PARAMETER		TEST CONDITIONS		MIN <sup>(1)</sup>	TYP <sup>(2)</sup>	MAX <sup>(1)</sup>	UNIT	
$V_{REF}$	Reference Voltage	LM1117I-ADJ $I_{OUT} = 10\text{ mA}$ , $V_{IN} - V_{OUT} = 2\text{ V}$ , $T_J = 25^\circ\text{C}$		1.238	1.25	1.262	V	
		LM1117I-ADJ $10\text{ mA} \leq I_{OUT} \leq 800\text{ mA}$ , $1.4\text{ V} \leq V_{IN} - V_{OUT} \leq 10\text{ V}$	$T_J = 25^\circ\text{C}$	1.25				
			over the junction temperature range $-40^\circ\text{C}$ to $125^\circ\text{C}$	1.2		1.29		
$V_{OUT}$	Output Voltage	LM1117I-3.3 $I_{OUT} = 10\text{ mA}$ , $V_{IN} = 5\text{ V}$ , $T_J = 25^\circ\text{C}$		3.267	3.3	3.333	V	
		LM1117I-3.3 $0 \leq I_{OUT} \leq 800\text{ mA}$ , $4.75\text{ V} \leq V_{IN} \leq 10\text{ V}$		3.3				
				over the junction temperature range $-40^\circ\text{C}$ to $125^\circ\text{C}$	3.168		3.432	
		LM1117I-5.0 $I_{OUT} = 10\text{ mA}$ , $V_{IN} = 7\text{ V}$ , $T_J = 25^\circ\text{C}$		4.95	5	5.05	V	
LM1117I-5.0 $0 \leq I_{OUT} \leq 800\text{ mA}$ , $6.5\text{ V} \leq V_{IN} \leq 12\text{ V}$		5						
		over the junction temperature range $-40^\circ\text{C}$ to $125^\circ\text{C}$	4.8		5.2			
$\Delta V_{OUT}$	Line Regulation <sup>(3)</sup>	LM1117I-ADJ $I_{OUT} = 10\text{ mA}$ , $1.5\text{ V} \leq V_{IN} - V_{OUT} \leq 13.75\text{ V}$		$T_J = 25^\circ\text{C}$		0.035%	mV	
				over the junction temperature range $-40^\circ\text{C}$ to $125^\circ\text{C}$		0.3%		
		LM1117I-3.3 $I_{OUT} = 0\text{ mA}$ , $4.75\text{ V} \leq V_{IN} \leq 15\text{ V}$		$T_J = 25^\circ\text{C}$		1		mV
				over the junction temperature range $-40^\circ\text{C}$ to $125^\circ\text{C}$		10		
		LM1117I-5.0 $I_{OUT} = 0\text{ mA}$ , $6.5\text{ V} \leq V_{IN} \leq 15\text{ V}$		$T_J = 25^\circ\text{C}$		1		mV
				over the junction temperature range $-40^\circ\text{C}$ to $125^\circ\text{C}$		15		
$\Delta V_{OUT}$	Load Regulation <sup>(3)</sup>	LM1117I-ADJ $V_{IN} - V_{OUT} = 3\text{ V}$ , $10 \leq I_{OUT} \leq 800\text{ mA}$		$T_J = 25^\circ\text{C}$		0.2%	mV	
				over the junction temperature range $-40^\circ\text{C}$ to $125^\circ\text{C}$		0.5%		
		LM1117I-3.3 $V_{IN} = 4.75\text{ V}$ , $0 \leq I_{OUT} \leq 800\text{ mA}$		$T_J = 25^\circ\text{C}$		1		mV
				over the junction temperature range $-40^\circ\text{C}$ to $125^\circ\text{C}$		15		
		LM1117I-5.0 $V_{IN} = 6.5\text{ V}$ , $0 \leq I_{OUT} \leq 800\text{ mA}$		$T_J = 25^\circ\text{C}$		1		mV
				over the junction temperature range $-40^\circ\text{C}$ to $125^\circ\text{C}$		20		

(1) All limits are ensured by testing or statistical analysis.

(2) Typical Values represent the most likely parametric normal.

(3) Load and line regulation are measured at constant junction room temperature.

**LM1117I Electrical Characteristics (continued)**

 unless otherwise specified,  $T_J = 25^\circ\text{C}$ .

PARAMETER	TEST CONDITIONS		MIN <sup>(1)</sup>	TYP <sup>(2)</sup>	MAX <sup>(1)</sup>	UNIT
$V_{IN} - V_{OUT}$ Dropout Voltage <sup>(4)</sup>	$I_{OUT} = 100\text{ mA}$	$T_J = 25^\circ\text{C}$	1.1		1.3	V
		over the junction temperature range $-40^\circ\text{C}$ to $125^\circ\text{C}$				
	$I_{OUT} = 500\text{ mA}$	$T_J = 25^\circ\text{C}$	1.15		1.35	V
		over the junction temperature range $-40^\circ\text{C}$ to $125^\circ\text{C}$				
	$I_{OUT} = 800\text{ mA}$	$T_J = 25^\circ\text{C}$	1.2		1.4	V
		over the junction temperature range $-40^\circ\text{C}$ to $125^\circ\text{C}$				
$I_{LIMIT}$ Current Limit	$V_{IN} - V_{OUT} = 5\text{ V}$ , $T_J = 25^\circ\text{C}$		800	1200	1500	mA
Minimum Load Current <sup>(5)</sup>	LM1117I-ADJ $V_{IN} = 15\text{ V}$	$T_J = 25^\circ\text{C}$	1.7		5	mA
		over the junction temperature range $-40^\circ\text{C}$ to $125^\circ\text{C}$				
Quiescent Current	LM1117I-3.3 $V_{IN} \leq 15\text{ V}$	$T_J = 25^\circ\text{C}$	5		15	mA
		over the junction temperature range $-40^\circ\text{C}$ to $125^\circ\text{C}$				
	LM1117I-5.0 $V_{IN} \leq 15\text{ V}$	$T_J = 25^\circ\text{C}$	5		15	mA
		over the junction temperature range $-40^\circ\text{C}$ to $125^\circ\text{C}$				
Thermal Regulation	$T_A = 25^\circ\text{C}$ , 30ms Pulse			0.01	0.1	%/W
Ripple Regulation	$f_{RIPPLE} = 120\text{ Hz}$ , $V_{IN} - V_{OUT} = 3\text{ V}$ $V_{RIPPLE} = 1\text{ V}_{PP}$	$T_J = 25^\circ\text{C}$	75		60	dB
		over the junction temperature range $-40^\circ\text{C}$ to $125^\circ\text{C}$				
Adjust Pin Current	$T_J = 25^\circ\text{C}$		60		120	$\mu\text{A}$
	over the junction temperature range $-40^\circ\text{C}$ to $125^\circ\text{C}$					
Adjust Pin Current Change	$10 \leq I_{OUT} \leq 800\text{ mA}$ , $1.4\text{ V} \leq V_{IN} - V_{OUT} \leq 10\text{ V}$	$T_J = 25^\circ\text{C}$	0.2		10	$\mu\text{A}$
		over the junction temperature range $-40^\circ\text{C}$ to $125^\circ\text{C}$				
Temperature Stability			0.5%			
Long Term Stability	$T_A = 125^\circ\text{C}$ , 1000 Hrs		0.3%			
RMS Output Noise	(% of $V_{OUT}$ ), $10\text{ Hz} \leq f \leq 10\text{ kHz}$		0.003%			

(4) The dropout voltage is the input/output differential at which the circuit ceases to regulate against further reduction in input voltage. It is measured when the output voltage has dropped 100 mV from the nominal value obtained at  $V_{IN} = V_{OUT} + 1.5\text{ V}$ .

(5) The minimum output current required to maintain regulation.

### 6.7 Typical Characteristics

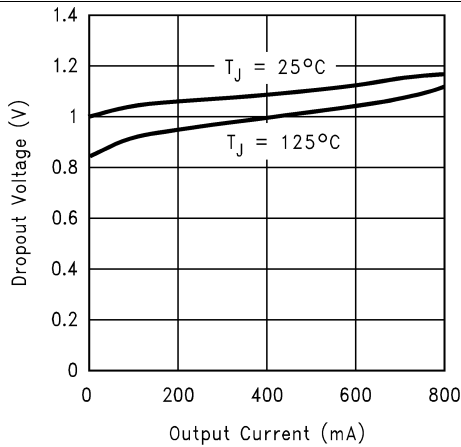

Figure 1. Dropout Voltage ( $V_{IN} - V_{OUT}$ )



Figure 2. Short-Circuit Current

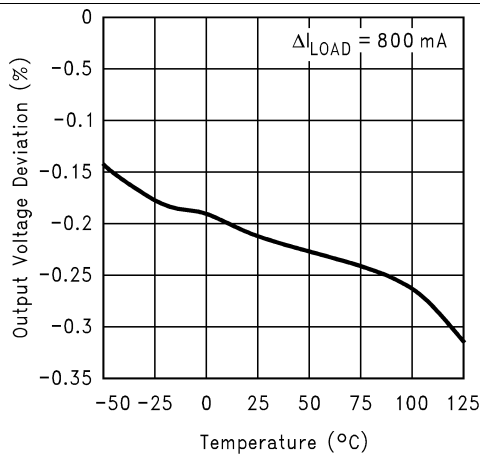

Figure 3. Load Regulation

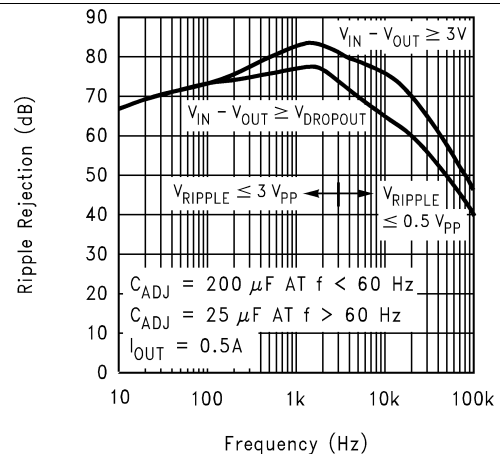

Figure 4. LM1117-ADJ Ripple Rejection

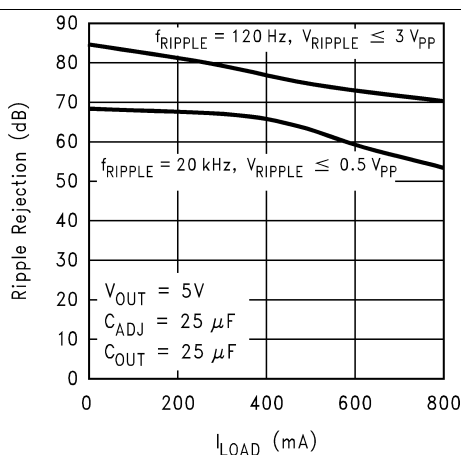

Figure 5. LM1117-ADJ Ripple Rejection vs Current

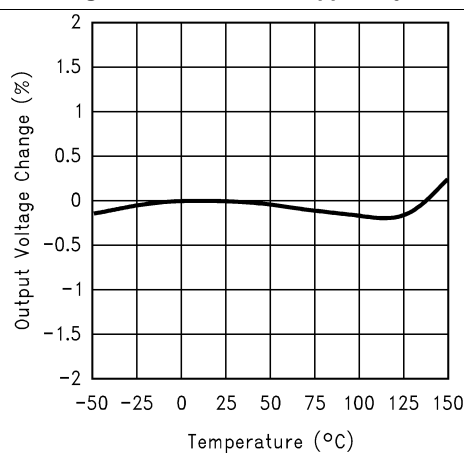
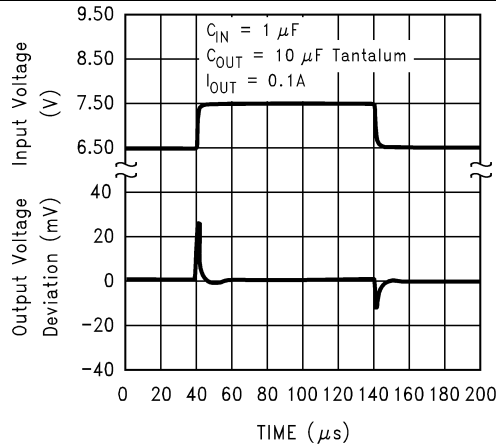

Figure 6. Temperature Stability

**Typical Characteristics (continued)**

**Figure 7. Adjust Pin Current**

**Figure 8. LM1117-5.0 Load Transient Response**

**Figure 9. LM1117-5.0 Line Transient Response**

## 7 Detailed Description

### 7.1 Overview

The LM1117 adjustable version develops a 1.25V reference voltage,  $V_{REF}$ , between the output and the adjust terminal. As shown in Figure 10, this voltage is applied across resistor R1 to generate a constant current I1. The current  $I_{ADJ}$  from the adjust terminal could introduce error to the output. But since it is very small (60µA) compared with the I1 and very constant with line and load changes, the error can be ignored. The constant current I1 then flows through the output set resistor R2 and sets the output voltage to the desired level.

For fixed voltage devices, R1 and R2 are integrated inside the devices.



Figure 10. Basic Adjustable Regulator

### 7.2 Functional Block Diagram



### 7.3 Feature Description

#### 7.3.1 Load Regulation

The LM1117 regulates the voltage that appears between its output and ground pins, or between its output and adjust pins. In some cases, line resistances can introduce errors to the voltage across the load. To obtain the best load regulation, a few precautions are needed.

## Feature Description (continued)

Figure 11, shows a typical application using a fixed output regulator. The  $R_{t1}$  and  $R_{t2}$  are the line resistances. It is obvious that the  $V_{LOAD}$  is less than the  $V_{OUT}$  by the sum of the voltage drops along the line resistances. In this case, the load regulation seen at the  $R_{LOAD}$  would be degraded from the data sheet specification. To improve this, the load should be tied directly to the output terminal on the positive side and directly tied to the ground terminal on the negative side.



**Figure 11. Typical Application Using Fixed Output Regulator**

When the adjustable regulator is used (Figure 12), the best performance is obtained with the positive side of the resistor  $R_1$  tied directly to the output terminal of the regulator rather than near the load. This eliminates line drops from appearing effectively in series with the reference and degrading regulation. For example, a 5V regulator with  $0.05\Omega$  resistance between the regulator and load will have a load regulation due to line resistance of  $0.05\Omega \times I_L$ . If  $R_1$  ( $=125\Omega$ ) is connected near the load, the effective line resistance will be  $0.05\Omega (1 + R_2/R_1)$  or in this case, it is 4 times worse. In addition, the ground side of the resistor  $R_2$  can be returned near the ground of the load to provide remote ground sensing and improve load regulation.



**Figure 12. Best Load Regulation Using Adjustable Output Regulator**

## 7.4 Device Functional Modes

### 7.4.1 Protection Diodes

Under normal operation, the LM1117 regulators do not need any protection diode. With the adjustable device, the internal resistance between the adjust and output terminals limits the current. No diode is needed to divert the current around the regulator even with capacitor on the adjust terminal. The adjust pin can take a transient signal of  $\pm 25V$  with respect to the output voltage without damaging the device.

When an output capacitor is connected to a regulator and the input is shorted to ground, the output capacitor will discharge into the output of the regulator. The discharge current depends on the value of the capacitor, the output voltage of the regulator, and rate of decrease of  $V_{IN}$ . In the LM1117 regulators, the internal diode between the output and input pins can withstand microsecond surge currents of 10A to 20A. With an extremely large output capacitor ( $\geq 1000 \mu F$ ), and with input instantaneously shorted to ground, the regulator could be damaged.

In this case, an external diode is recommended between the output and input pins to protect the regulator, as shown in Figure 13.

Device Functional Modes (continued)



Figure 13. Regulator With Protection Diode

## 8 Application and Implementation

### NOTE

Information in the following applications sections is not part of the TI component specification, and TI does not warrant its accuracy or completeness. TI's customers are responsible for determining suitability of components for their purposes. Customers should validate and test their design implementation to confirm system functionality.

### 8.1 Application Information

The LM1117 is a versatile and high performance linear regulator with a wide temperature range and tight line/load regulation operation. An output capacitor is required to further improve transient response and stability. For the adjustable option, the ADJ pin can also be bypassed to achieve very high ripple-rejection ratios. The LM1117 is versatile in its applications, including its uses as a post regulator for DC/DC converters, battery chargers, and microprocessor supplies.

### 8.2 Typical Application



\*  $C_{Adj}$  is optional, however it will improve ripple rejection.

**Figure 14. 1.25-V to 10-V Adjustable Regulator With Improved Ripple Rejection**

#### 8.2.1 Design Requirements

The device component count is very minimal, employing two resistors as part of a voltage divider circuit and an output capacitor for load regulation. A 10-µF tantalum on the input is a suitable input capacitor for almost all applications. An optional bypass capacitor across R2 can also be used to improve PSRR. See [Recommended Operating Conditions](#) for more information.

#### 8.2.2 Detailed Design Procedure

The output voltage is set based on the selection of the two resistors, R1 and R2, as shown in [Figure 14](#). For details on capacitor selection, refer to [External Capacitors](#).

##### 8.2.2.1 External Capacitors

###### 8.2.2.1.1 Input Bypass Capacitor

An input capacitor is recommended. A 10-µF tantalum on the input is a suitable input capacitor for almost all applications.

## Typical Application (continued)

### 8.2.2.1.2 Adjust Terminal Bypass Capacitor

The adjust terminal can be bypassed to ground with a bypass capacitor ( $C_{ADJ}$ ) to improve ripple rejection. This bypass capacitor prevents ripple from being amplified as the output voltage is increased. At any ripple frequency, the impedance of the  $C_{ADJ}$  should be less than  $R1$  to prevent the ripple from being amplified:

$$1/(2\pi \times f_{RIPPLE} \times C_{ADJ}) < R1 \tag{1}$$

The  $R1$  is the resistor between the output and the adjust pin. Its value is normally in the range of 100-200Ω. For example, with  $R1 = 124\Omega$  and  $f_{RIPPLE} = 120\text{Hz}$ , the  $C_{ADJ}$  should be  $> 11\mu\text{F}$ .

### 8.2.2.1.3 Output Capacitor

The output capacitor is critical in maintaining regulator stability, and must meet the required conditions for both minimum amount of capacitance and equivalent series resistance (ESR). The minimum output capacitance required by the LM1117 is 10 μF, if a tantalum capacitor is used. Any increase of the output capacitance will merely improve the loop stability and transient response. The ESR of the output capacitor should range between 0.3 Ω to 22 Ω. In the case of the adjustable regulator, when the  $C_{ADJ}$  is used, a larger output capacitance (22-μF tantalum) is required.

## 8.2.3 Application Curve

As shown in [Figure 15](#), the dropout voltage will vary with output current and temperature. Care should be taken during design to ensure the dropout voltage requirement is met across the entire operating temperature and output current range.



**Figure 15. Dropout Voltage ( $V_{IN} - V_{OUT}$ )**

### 8.3 System Examples

Several circuits can be realized with the LM1117. The circuit diagrams in this section demonstrate multiple system examples that can be utilized in many applications.



\* Required if the regulator is located far from the power supply filter.

Figure 16. Fixed Output Regulator



Figure 17. Adjusting Output of Fixed Regulators

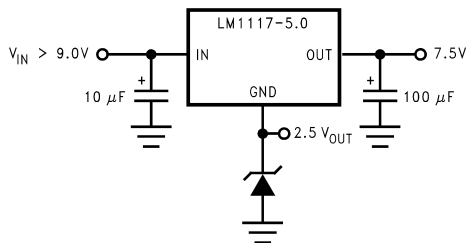

Figure 18. Regulator With Reference



\* Min. output  $\approx$  1.25V

Figure 19. 5-V Logic Regulator With Electronic Shutdown\*



\* Select for charge rate.

Figure 20. Battery Backed-Up Regulated Supply



Figure 21. Low Dropout Negative Supply

## 9 Power Supply Recommendations

The input supply to the LM1117 must be kept at a voltage level such that its maximum rating is not exceeded. The minimum dropout voltage must also be met with extra headroom when possible to keep the LM1117 in regulation. An input capacitor is recommended. For more information regarding capacitor selection, refer to [External Capacitors](#).

## 10 Layout

### 10.1 Layout Guidelines

Some layout guidelines must be followed to ensure proper regulation of the output voltage with minimum noise. Traces carrying the load current must be wide to reduce the amount of parasitic trace inductance and the feedback loop from  $V_{OUT}$  to ADJ must be kept as short as possible. To improve PSRR, a bypass capacitor can be placed at the ADJ pin and must be located as close as possible to the IC. In cases when  $V_{IN}$  shorts to ground, an external diode must be placed from  $V_{OUT}$  to  $V_{IN}$  to divert the surge current from the output capacitor and protect the IC. The diode must be placed close to the corresponding IC pins to increase their effectiveness.

#### 10.1.1 Heatsink Requirements

When an integrated circuit operates with an appreciable current, its junction temperature is elevated. It is important to quantify its thermal limits in order to achieve acceptable performance and reliability. This limit is determined by summing the individual parts consisting of a series of temperature rises from the semiconductor junction to the operating environment. A one-dimensional steady-state model of conduction heat transfer is demonstrated in [Figure 22](#). The heat generated at the device junction flows through the die to the die attach pad, through the lead frame to the surrounding case material, to the printed circuit board, and eventually to the ambient environment. Below is a list of variables that may affect the thermal resistance and in turn the need for a heatsink.

**Table 1. Component and Application Variables**

$R_{\theta JC}$ (COMPONENT VARIABLES)	$R_{\theta JA}$ (APPLICATION VARIABLES)
Leadframe Size and Material	Mounting Pad Size, Material, and Location
No. of Conduction Pins	Placement of Mounting Pad
Die Size	PCB Size and Material
Die Attach Material	Traces Length and Width
Molding Compound Size and Material	Adjacent Heat Sources
	Volume of Air
	Ambient Temperature
	Shape of Mounting Pad



The case temperature is measured at the point where the leads contact with the mounting pad surface

**Figure 22. Cross-Sectional View of Integrated Circuit Mounted on a Printed Circuit Board**

The LM1117 regulators have internal thermal shutdown to protect the device from over-heating. Under all possible operating conditions, the junction temperature of the LM1117 must be within the range of 0°C to 125°C. A heatsink may be required depending on the maximum power dissipation and maximum ambient temperature of the application. To determine if a heatsink is needed, the power dissipated by the regulator,  $P_D$ , must be calculated:

$$I_{IN} = I_L + I_G \quad (2)$$

$$P_D = (V_{IN} - V_{OUT})I_L + V_{IN}I_G \quad (3)$$

Figure 23 shows the voltages and currents which are present in the circuit.



**Figure 23. Power Dissipation Diagram**

The next parameter which must be calculated is the maximum allowable temperature rise,  $T_R(\max)$ :

$$T_R(\max) = T_J(\max) - T_A(\max)$$

where

- $T_J(\max)$  is the maximum allowable junction temperature (125°C) which will be encountered in the application
- $T_A(\max)$  is the maximum ambient temperature which will be encountered in the application (4)

Using the calculated values for  $T_R(\max)$  and  $P_D$ , the maximum allowable value for the junction-to-ambient thermal resistance ( $R_{\theta JA}$ ) can be calculated:

$$R_{\theta JA} = T_R(\max) / P_D \quad (5)$$

For the maximum allowable value for  $\theta_{JA}$ , refer to the [Thermal Information](#) table.

As a design aid, [Table 2](#) shows the value of the  $\theta_{JA}$  of SOT-223 and TO-252 for different heatsink area. [Figure 24](#) and [Figure 25](#) reflects the same test results as what are in the [Table 2](#)

[Figure 26](#) and [Figure 27](#) shows the maximum allowable power dissipation vs. ambient temperature for the SOT-223 and TO-252 device. [Figure 28](#) and [Figure 29](#) shows the maximum allowable power dissipation vs. copper area (in<sup>2</sup>) for the SOT-223 and TO-252 devices. Please see AN1028 for power enhancement techniques to be used with SOT-223 and TO-252 packages.

Application Note AN-1187 ([SNOA401](#)) discusses improved thermal performance and power dissipation for the WSON.

**Table 2.  $R_{\theta JA}$  Different Heatsink Area**

LAYOUT	COPPER AREA		THERMAL RESISTANCE	
	Top Side (in <sup>2</sup> ) <sup>(1)</sup>	Bottom Side (in <sup>2</sup> )	( $\theta_{JA}$ , °C/W) SOT-223	( $\theta_{JA}$ , °C/W) TO-252
1	0.0123	0	136	103
2	0.066	0	123	87
3	0.3	0	84	60
4	0.53	0	75	54
5	0.76	0	69	52
6	1	0	66	47
7	0	0.2	115	84
8	0	0.4	98	70
9	0	0.6	89	63
10	0	0.8	82	57

(1) Tab of device attached to topside copper

Table 2.  $R_{\theta JA}$  Different Heatsink Area (continued)

LAYOUT	COPPER AREA		THERMAL RESISTANCE	
11	0	1	79	57
12	0.066	0.066	125	89
13	0.175	0.175	93	72
14	0.284	0.284	83	61
15	0.392	0.392	75	55
16	0.5	0.5	70	53



Figure 24.  $R_{\theta JA}$  vs 1-oz Copper Area for SOT-223



Figure 25.  $R_{\theta JA}$  vs 2-oz Copper Area for TO-252



Figure 26. Maximum Allowable Power Dissipation vs Ambient Temperature for SOT-223



Figure 27. Maximum Allowable Power Dissipation vs Ambient Temperature for TO-252



Figure 28. Maximum Allowable Power Dissipation vs 1-oz Copper Area for SOT-223



Figure 29. Maximum Allowable Power Dissipation vs 2-oz Copper Area for TO-252



**Figure 30. Top View of the Thermal Test Pattern in Actual Scale**



**Figure 31. Bottom View of the Thermal Test Pattern in Actual Scale**

## 10.2 Layout Example



Figure 32. Layout Example (SOT-223)

## 11 Device and Documentation Support

### 11.1 Community Resources

The following links connect to TI community resources. Linked contents are provided "AS IS" by the respective contributors. They do not constitute TI specifications and do not necessarily reflect TI's views; see TI's [Terms of Use](#).

**TI E2E™ Online Community** *TI's Engineer-to-Engineer (E2E) Community*. Created to foster collaboration among engineers. At [e2e.ti.com](http://e2e.ti.com), you can ask questions, share knowledge, explore ideas and help solve problems with fellow engineers.

**Design Support** *TI's Design Support* Quickly find helpful E2E forums along with design support tools and contact information for technical support.

### 11.2 Trademarks

E2E is a trademark of Texas Instruments.  
All other trademarks are the property of their respective owners.

### 11.3 Electrostatic Discharge Caution



These devices have limited built-in ESD protection. The leads should be shorted together or the device placed in conductive foam during storage or handling to prevent electrostatic damage to the MOS gates.

### 11.4 Glossary

[SLYZ022](#) — *TI Glossary*.

This glossary lists and explains terms, acronyms, and definitions.

## 12 Mechanical, Packaging, and Orderable Information

The following pages include mechanical, packaging, and orderable information. This information is the most current data available for the designated devices. This data is subject to change without notice and revision of this document. For browser-based versions of this data sheet, refer to the left-hand navigation.

**PACKAGING INFORMATION**

Orderable Device	Status (1)	Package Type	Package Drawing	Pins	Package Qty	Eco Plan (2)	Lead/Ball Finish (6)	MSL Peak Temp (3)	Op Temp (°C)	Device Marking (4/5)	Samples
LM1117DT-1.8/NOPB	ACTIVE	TO-252	NDP	3	75	Green (RoHS & no Sb/Br)	CU SN	Level-2-260C-1 YEAR	0 to 125	LM1117 DT-1.8	<a href="#">Samples</a>
LM1117DT-2.5/NOPB	ACTIVE	TO-252	NDP	3	75	Green (RoHS & no Sb/Br)	CU SN	Level-2-260C-1 YEAR	0 to 125	LM1117 DT-2.5	<a href="#">Samples</a>
LM1117DT-3.3/NOPB	ACTIVE	TO-252	NDP	3	75	Green (RoHS & no Sb/Br)	CU SN	Level-2-260C-1 YEAR	0 to 125	LM1117 DT-3.3	<a href="#">Samples</a>
LM1117DT-5.0/NOPB	ACTIVE	TO-252	NDP	3	75	Green (RoHS & no Sb/Br)	CU SN	Level-2-260C-1 YEAR	0 to 125	LM1117 DT-5.0	<a href="#">Samples</a>
LM1117DT-ADJ/NOPB	ACTIVE	TO-252	NDP	3	75	Green (RoHS & no Sb/Br)	CU SN	Level-2-260C-1 YEAR	0 to 125	LM1117 DT-ADJ	<a href="#">Samples</a>
LM1117DTX-1.8/NOPB	ACTIVE	TO-252	NDP	3	2500	Green (RoHS & no Sb/Br)	CU SN	Level-2-260C-1 YEAR	0 to 125	LM1117 DT-1.8	<a href="#">Samples</a>
LM1117DTX-2.5/NOPB	ACTIVE	TO-252	NDP	3	2500	Green (RoHS & no Sb/Br)	CU SN	Level-2-260C-1 YEAR	0 to 125	LM1117 DT-2.5	<a href="#">Samples</a>
LM1117DTX-3.3/NOPB	ACTIVE	TO-252	NDP	3	2500	Green (RoHS & no Sb/Br)	CU SN	Level-2-260C-1 YEAR	0 to 125	LM1117 DT-3.3	<a href="#">Samples</a>
LM1117DTX-5.0/NOPB	ACTIVE	TO-252	NDP	3	2500	Green (RoHS & no Sb/Br)	CU SN	Level-2-260C-1 YEAR	0 to 125	LM1117 DT-5.0	<a href="#">Samples</a>
LM1117DTX-ADJ/NOPB	ACTIVE	TO-252	NDP	3	2500	Green (RoHS & no Sb/Br)	CU SN	Level-2-260C-1 YEAR	0 to 125	LM1117 DT-ADJ	<a href="#">Samples</a>
LM1117IDT-3.3/NOPB	ACTIVE	TO-252	NDP	3	75	Green (RoHS & no Sb/Br)	CU SN	Level-2-260C-1 YEAR	-40 to 125	LM1117 IDT-3.3	<a href="#">Samples</a>
LM1117IDT-5.0/NOPB	ACTIVE	TO-252	NDP	3	75	Green (RoHS & no Sb/Br)	CU SN	Level-2-260C-1 YEAR	-40 to 125	LM1117 IDT-5.0	<a href="#">Samples</a>
LM1117IDT-ADJ/NOPB	ACTIVE	TO-252	NDP	3	75	Green (RoHS & no Sb/Br)	CU SN	Level-2-260C-1 YEAR	-40 to 125	LM1117 IDT-ADJ	<a href="#">Samples</a>
LM1117IDTX-3.3/NOPB	ACTIVE	TO-252	NDP	3	2500	Green (RoHS & no Sb/Br)	CU SN	Level-2-260C-1 YEAR	-40 to 125	LM1117 IDT-3.3	<a href="#">Samples</a>
LM1117IDTX-5.0/NOPB	ACTIVE	TO-252	NDP	3	2500	Green (RoHS & no Sb/Br)	CU SN	Level-2-260C-1 YEAR	-40 to 125	LM1117 IDT-5.0	<a href="#">Samples</a>
LM1117IDTX-ADJ/NOPB	ACTIVE	TO-252	NDP	3	2500	Green (RoHS & no Sb/Br)	CU SN	Level-2-260C-1 YEAR	-40 to 125	LM1117 IDT-ADJ	<a href="#">Samples</a>
LM1117ILD-ADJ/NOPB	ACTIVE	WSON	NGN	8	1000	Green (RoHS & no Sb/Br)	CU SN	Level-3-260C-168 HR	-40 to 125	1117IAD	<a href="#">Samples</a>

Orderable Device	Status (1)	Package Type	Package Drawing	Pins	Package Qty	Eco Plan (2)	Lead/Ball Finish (6)	MSL Peak Temp (3)	Op Temp (°C)	Device Marking (4/5)	Samples
LM1117IMP-3.3/NOPB	ACTIVE	SOT-223	DCY	4	1000	Green (RoHS & no Sb/Br)	CU SN	Level-1-260C-UNLIM	-40 to 125	N05B	<a href="#">Samples</a>
LM1117IMP-5.0/NOPB	ACTIVE	SOT-223	DCY	4	1000	Green (RoHS & no Sb/Br)	CU SN	Level-1-260C-UNLIM	-40 to 125	N06B	<a href="#">Samples</a>
LM1117IMP-ADJ/NOPB	ACTIVE	SOT-223	DCY	4	1000	Green (RoHS & no Sb/Br)	CU SN	Level-1-260C-UNLIM	-40 to 125	N03B	<a href="#">Samples</a>
LM1117IMPX-3.3/NOPB	ACTIVE	SOT-223	DCY	4	2000	Green (RoHS & no Sb/Br)	CU SN	Level-1-260C-UNLIM	-40 to 125	N05B	<a href="#">Samples</a>
LM1117IMPX-5.0/NOPB	ACTIVE	SOT-223	DCY	4	2000	Green (RoHS & no Sb/Br)	CU SN	Level-1-260C-UNLIM	-40 to 125	N06B	<a href="#">Samples</a>
LM1117IMPX-ADJ/NOPB	ACTIVE	SOT-223	DCY	4	2000	Green (RoHS & no Sb/Br)	CU SN	Level-1-260C-UNLIM	-40 to 125	N03B	<a href="#">Samples</a>
LM1117LD-1.8/NOPB	ACTIVE	WSON	NGN	8	1000	Green (RoHS & no Sb/Br)	CU SN	Level-3-260C-168 HR	0 to 125	1117-18	<a href="#">Samples</a>
LM1117LD-2.5/NOPB	ACTIVE	WSON	NGN	8	1000	Green (RoHS & no Sb/Br)	CU SN	Level-3-260C-168 HR	0 to 125	1117-25	<a href="#">Samples</a>
LM1117LD-3.3/NOPB	ACTIVE	WSON	NGN	8	1000	Green (RoHS & no Sb/Br)	CU SN	Level-3-260C-168 HR	0 to 125	1117-33	<a href="#">Samples</a>
LM1117LD-ADJ/NOPB	ACTIVE	WSON	NGN	8	1000	Green (RoHS & no Sb/Br)	CU SN	Level-3-260C-168 HR	0 to 125	1117ADJ	<a href="#">Samples</a>
LM1117LDX-1.8/NOPB	ACTIVE	WSON	NGN	8	4500	Green (RoHS & no Sb/Br)	CU SN	Level-3-260C-168 HR	0 to 125	1117-18	<a href="#">Samples</a>
LM1117LDX-ADJ/NOPB	ACTIVE	WSON	NGN	8	4500	Green (RoHS & no Sb/Br)	CU SN	Level-3-260C-168 HR	0 to 125	1117ADJ	<a href="#">Samples</a>
LM1117MP-1.8/NOPB	ACTIVE	SOT-223	DCY	4	1000	Green (RoHS & no Sb/Br)	CU SN	Level-1-260C-UNLIM	0 to 125	N12A	<a href="#">Samples</a>
LM1117MP-2.5/NOPB	ACTIVE	SOT-223	DCY	4	1000	Green (RoHS & no Sb/Br)	CU SN	Level-1-260C-UNLIM	0 to 125	N13A	<a href="#">Samples</a>
LM1117MP-3.3/NOPB	ACTIVE	SOT-223	DCY	4	1000	Green (RoHS & no Sb/Br)	CU SN	Level-1-260C-UNLIM	0 to 125	N05A	<a href="#">Samples</a>
LM1117MP-5.0/NOPB	ACTIVE	SOT-223	DCY	4	1000	Green (RoHS & no Sb/Br)	CU SN	Level-1-260C-UNLIM	0 to 125	N06A	<a href="#">Samples</a>
LM1117MP-ADJ/NOPB	ACTIVE	SOT-223	DCY	4	1000	Green (RoHS & no Sb/Br)	CU SN	Level-1-260C-UNLIM	0 to 125	N03A	<a href="#">Samples</a>
LM1117MPX-1.8/NOPB	ACTIVE	SOT-223	DCY	4	2000	Green (RoHS & no Sb/Br)	CU SN	Level-1-260C-UNLIM	0 to 125	N12A	<a href="#">Samples</a>

Orderable Device	Status (1)	Package Type	Package Drawing	Pins	Package Qty	Eco Plan (2)	Lead/Ball Finish (6)	MSL Peak Temp (3)	Op Temp (°C)	Device Marking (4/5)	Samples
LM1117MPX-2.5/NOPB	ACTIVE	SOT-223	DCY	4	2000	Green (RoHS & no Sb/Br)	CU SN	Level-1-260C-UNLIM	0 to 125	N13A	<a href="#">Samples</a>
LM1117MPX-3.3	ACTIVE	SOT-223	DCY	4	2000	TBD	Call TI	Call TI		N05A	<a href="#">Samples</a>
LM1117MPX-3.3/NOPB	ACTIVE	SOT-223	DCY	4	2000	Green (RoHS & no Sb/Br)	CU SN	Level-1-260C-UNLIM	0 to 125	N05A	<a href="#">Samples</a>
LM1117MPX-5.0/NOPB	ACTIVE	SOT-223	DCY	4	2000	Green (RoHS & no Sb/Br)	CU SN	Level-1-260C-UNLIM	0 to 125	N06A	<a href="#">Samples</a>
LM1117MPX-ADJ/NOPB	ACTIVE	SOT-223	DCY	4	2000	Green (RoHS & no Sb/Br)	CU SN	Level-1-260C-UNLIM	0 to 125	N03A	<a href="#">Samples</a>
LM1117S-ADJ/NOPB	ACTIVE	DDPAK/ TO-263	KTT	3	45	Pb-Free (RoHS Exempt)	CU SN	Level-3-245C-168 HR	0 to 125	LM1117S ADJ	<a href="#">Samples</a>
LM1117SX-3.3/NOPB	ACTIVE	DDPAK/ TO-263	KTT	3	500	Pb-Free (RoHS Exempt)	CU SN	Level-3-245C-168 HR	0 to 125	LM1117S 3.3	<a href="#">Samples</a>
LM1117SX-5.0/NOPB	ACTIVE	DDPAK/ TO-263	KTT	3	500	Pb-Free (RoHS Exempt)	CU SN	Level-3-245C-168 HR	0 to 125	LM1117S 5.0	<a href="#">Samples</a>
LM1117SX-ADJ/NOPB	ACTIVE	DDPAK/ TO-263	KTT	3	500	Pb-Free (RoHS Exempt)	CU SN	Level-3-245C-168 HR	0 to 125	LM1117S ADJ	<a href="#">Samples</a>
LM1117T-2.5/NOPB	ACTIVE	TO-220	NDE	3	45	Green (RoHS & no Sb/Br)	CU SN	Level-1-NA-UNLIM	0 to 125	LM1117T 2.5	<a href="#">Samples</a>
LM1117T-3.3/NOPB	ACTIVE	TO-220	NDE	3	45	Green (RoHS & no Sb/Br)	CU SN	Level-1-NA-UNLIM	0 to 125	LM1117T 3.3	<a href="#">Samples</a>
LM1117T-5.0/NOPB	ACTIVE	TO-220	NDE	3	45	Green (RoHS & no Sb/Br)	CU SN	Level-1-NA-UNLIM	0 to 125	LM1117T 5.0	<a href="#">Samples</a>
LM1117T-ADJ/NOPB	ACTIVE	TO-220	NDE	3	45	Green (RoHS & no Sb/Br)	CU SN	Level-1-NA-UNLIM	0 to 125	LM1117T ADJ	<a href="#">Samples</a>

(1) The marketing status values are defined as follows:

**ACTIVE:** Product device recommended for new designs.

**LIFEBUY:** TI has announced that the device will be discontinued, and a lifetime-buy period is in effect.

**NRND:** Not recommended for new designs. Device is in production to support existing customers, but TI does not recommend using this part in a new design.

**PREVIEW:** Device has been announced but is not in production. Samples may or may not be available.

**OBSOLETE:** TI has discontinued the production of the device.

(2) **RoHS:** TI defines "RoHS" to mean semiconductor products that are compliant with the current EU RoHS requirements for all 10 RoHS substances, including the requirement that RoHS substance do not exceed 0.1% by weight in homogeneous materials. Where designed to be soldered at high temperatures, "RoHS" products are suitable for use in specified lead-free processes. TI may reference these types of products as "Pb-Free".

**RoHS Exempt:** TI defines "RoHS Exempt" to mean products that contain lead but are compliant with EU RoHS pursuant to a specific EU RoHS exemption.

---

**Green:** TI defines "Green" to mean the content of Chlorine (Cl) and Bromine (Br) based flame retardants meet JS709B low halogen requirements of  $\leq 1000$ ppm threshold. Antimony trioxide based flame retardants must also meet the  $\leq 1000$ ppm threshold requirement.

(3) MSL, Peak Temp. - The Moisture Sensitivity Level rating according to the JEDEC industry standard classifications, and peak solder temperature.

(4) There may be additional marking, which relates to the logo, the lot trace code information, or the environmental category on the device.

(5) Multiple Device Markings will be inside parentheses. Only one Device Marking contained in parentheses and separated by a "~" will appear on a device. If a line is indented then it is a continuation of the previous line and the two combined represent the entire Device Marking for that device.

(6) Lead/Ball Finish - Orderable Devices may have multiple material finish options. Finish options are separated by a vertical ruled line. Lead/Ball Finish values may wrap to two lines if the finish value exceeds the maximum column width.

**Important Information and Disclaimer:** The information provided on this page represents TI's knowledge and belief as of the date that it is provided. TI bases its knowledge and belief on information provided by third parties, and makes no representation or warranty as to the accuracy of such information. Efforts are underway to better integrate information from third parties. TI has taken and continues to take reasonable steps to provide representative and accurate information but may not have conducted destructive testing or chemical analysis on incoming materials and chemicals. TI and TI suppliers consider certain information to be proprietary, and thus CAS numbers and other limited information may not be available for release.

In no event shall TI's liability arising out of such information exceed the total purchase price of the TI part(s) at issue in this document sold by TI to Customer on an annual basis.

**TAPE AND REEL INFORMATION**

**QUADRANT ASSIGNMENTS FOR PIN 1 ORIENTATION IN TAPE**

\*All dimensions are nominal

Device	Package Type	Package Drawing	Pins	SPQ	Reel Diameter (mm)	Reel Width W1 (mm)	A0 (mm)	B0 (mm)	K0 (mm)	P1 (mm)	W (mm)	Pin1 Quadrant
LM1117DTX-1.8/NOPB	TO-252	NDP	3	2500	330.0	16.4	6.9	10.5	2.7	8.0	16.0	Q2
LM1117DTX-2.5/NOPB	TO-252	NDP	3	2500	330.0	16.4	6.9	10.5	2.7	8.0	16.0	Q2
LM1117DTX-3.3/NOPB	TO-252	NDP	3	2500	330.0	16.4	6.9	10.5	2.7	8.0	16.0	Q2
LM1117DTX-5.0/NOPB	TO-252	NDP	3	2500	330.0	16.4	6.9	10.5	2.7	8.0	16.0	Q2
LM1117DTX-ADJ/NOPB	TO-252	NDP	3	2500	330.0	16.4	6.9	10.5	2.7	8.0	16.0	Q2
LM1117IDTX-3.3/NOPB	TO-252	NDP	3	2500	330.0	16.4	6.9	10.5	2.7	8.0	16.0	Q2
LM1117IDTX-5.0/NOPB	TO-252	NDP	3	2500	330.0	16.4	6.9	10.5	2.7	8.0	16.0	Q2
LM1117IDTX-ADJ/NOPB	TO-252	NDP	3	2500	330.0	16.4	6.9	10.5	2.7	8.0	16.0	Q2
LM1117ILD-ADJ/NOPB	WSON	NGN	8	1000	178.0	12.4	4.3	4.3	1.3	8.0	12.0	Q1
LM1117IMP-3.3/NOPB	SOT-223	DCY	4	1000	330.0	16.4	7.0	7.5	2.2	12.0	16.0	Q3
LM1117IMP-5.0/NOPB	SOT-223	DCY	4	1000	330.0	16.4	7.0	7.5	2.2	12.0	16.0	Q3
LM1117IMP-ADJ/NOPB	SOT-223	DCY	4	1000	330.0	16.4	7.0	7.5	2.2	12.0	16.0	Q3
LM1117IMPX-3.3/NOPB	SOT-223	DCY	4	2000	330.0	16.4	7.0	7.5	2.2	12.0	16.0	Q3
LM1117IMPX-5.0/NOPB	SOT-223	DCY	4	2000	330.0	16.4	7.0	7.5	2.2	12.0	16.0	Q3
LM1117IMPX-ADJ/NOPB	SOT-223	DCY	4	2000	330.0	16.4	7.0	7.5	2.2	12.0	16.0	Q3
LM1117LD-1.8/NOPB	WSON	NGN	8	1000	178.0	12.4	4.3	4.3	1.3	8.0	12.0	Q1
LM1117LD-2.5/NOPB	WSON	NGN	8	1000	178.0	12.4	4.3	4.3	1.3	8.0	12.0	Q1
LM1117LD-3.3/NOPB	WSON	NGN	8	1000	178.0	12.4	4.3	4.3	1.3	8.0	12.0	Q1

Device	Package Type	Package Drawing	Pins	SPQ	Reel Diameter (mm)	Reel Width W1 (mm)	A0 (mm)	B0 (mm)	K0 (mm)	P1 (mm)	W (mm)	Pin1 Quadrant
LM1117LD-ADJ/NOPB	WSON	NGN	8	1000	178.0	12.4	4.3	4.3	1.3	8.0	12.0	Q1
LM1117LDX-1.8/NOPB	WSON	NGN	8	4500	330.0	12.4	4.3	4.3	1.3	8.0	12.0	Q1
LM1117LDX-ADJ/NOPB	WSON	NGN	8	4500	330.0	12.4	4.3	4.3	1.3	8.0	12.0	Q1
LM1117MP-1.8/NOPB	SOT-223	DCY	4	1000	330.0	16.4	7.0	7.5	2.2	12.0	16.0	Q3
LM1117MP-2.5/NOPB	SOT-223	DCY	4	1000	330.0	16.4	7.0	7.5	2.2	12.0	16.0	Q3
LM1117MP-3.3/NOPB	SOT-223	DCY	4	1000	330.0	16.4	7.0	7.5	2.2	12.0	16.0	Q3
LM1117MP-5.0/NOPB	SOT-223	DCY	4	1000	330.0	16.4	7.0	7.5	2.2	12.0	16.0	Q3
LM1117MP-ADJ/NOPB	SOT-223	DCY	4	1000	330.0	16.4	7.0	7.5	2.2	12.0	16.0	Q3
LM1117MPX-1.8/NOPB	SOT-223	DCY	4	2000	330.0	16.4	7.0	7.5	2.2	12.0	16.0	Q3
LM1117MPX-2.5/NOPB	SOT-223	DCY	4	2000	330.0	16.4	7.0	7.5	2.2	12.0	16.0	Q3
LM1117MPX-3.3	SOT-223	DCY	4	2000	330.0	16.4	7.0	7.5	2.2	12.0	16.0	Q3
LM1117MPX-3.3/NOPB	SOT-223	DCY	4	2000	330.0	16.4	7.0	7.5	2.2	12.0	16.0	Q3
LM1117MPX-5.0/NOPB	SOT-223	DCY	4	2000	330.0	16.4	7.0	7.5	2.2	12.0	16.0	Q3
LM1117MPX-ADJ/NOPB	SOT-223	DCY	4	2000	330.0	16.4	7.0	7.5	2.2	12.0	16.0	Q3
LM1117SX-3.3/NOPB	DDPAK/ TO-263	KTT	3	500	330.0	24.4	10.75	14.85	5.0	16.0	24.0	Q2
LM1117SX-5.0/NOPB	DDPAK/ TO-263	KTT	3	500	330.0	24.4	10.75	14.85	5.0	16.0	24.0	Q2
LM1117SX-ADJ/NOPB	DDPAK/ TO-263	KTT	3	500	330.0	24.4	10.75	14.85	5.0	16.0	24.0	Q2

## TAPE AND REEL BOX DIMENSIONS

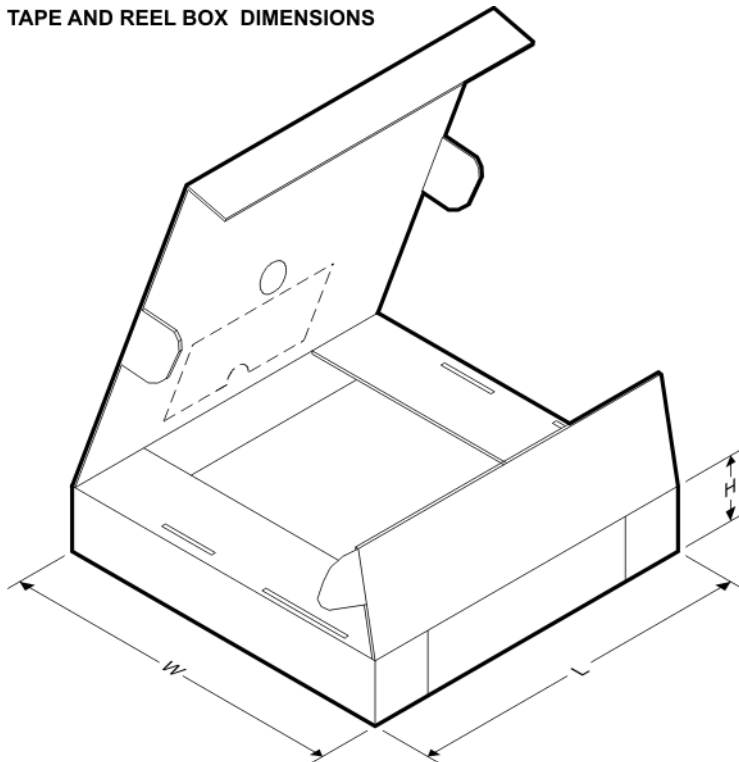

\*All dimensions are nominal

Device	Package Type	Package Drawing	Pins	SPQ	Length (mm)	Width (mm)	Height (mm)
LM1117DTX-1.8/NOPB	TO-252	NDP	3	2500	367.0	367.0	38.0
LM1117DTX-2.5/NOPB	TO-252	NDP	3	2500	367.0	367.0	38.0
LM1117DTX-3.3/NOPB	TO-252	NDP	3	2500	367.0	367.0	38.0
LM1117DTX-5.0/NOPB	TO-252	NDP	3	2500	367.0	367.0	38.0
LM1117DTX-ADJ/NOPB	TO-252	NDP	3	2500	367.0	367.0	38.0
LM1117IDTX-3.3/NOPB	TO-252	NDP	3	2500	367.0	367.0	38.0
LM1117IDTX-5.0/NOPB	TO-252	NDP	3	2500	367.0	367.0	38.0
LM1117IDTX-ADJ/NOPB	TO-252	NDP	3	2500	367.0	367.0	38.0
LM1117ILD-ADJ/NOPB	WSON	NGN	8	1000	210.0	185.0	35.0
LM1117IMP-3.3/NOPB	SOT-223	DCY	4	1000	367.0	367.0	35.0
LM1117IMP-5.0/NOPB	SOT-223	DCY	4	1000	367.0	367.0	35.0
LM1117IMP-ADJ/NOPB	SOT-223	DCY	4	1000	367.0	367.0	35.0
LM1117IMPX-3.3/NOPB	SOT-223	DCY	4	2000	367.0	367.0	35.0
LM1117IMPX-5.0/NOPB	SOT-223	DCY	4	2000	367.0	367.0	35.0
LM1117IMPX-ADJ/NOPB	SOT-223	DCY	4	2000	367.0	367.0	35.0
LM1117LD-1.8/NOPB	WSON	NGN	8	1000	210.0	185.0	35.0
LM1117LD-2.5/NOPB	WSON	NGN	8	1000	210.0	185.0	35.0
LM1117LD-3.3/NOPB	WSON	NGN	8	1000	210.0	185.0	35.0
LM1117LD-ADJ/NOPB	WSON	NGN	8	1000	210.0	185.0	35.0
LM1117LDX-1.8/NOPB	WSON	NGN	8	4500	367.0	367.0	35.0
LM1117LDX-ADJ/NOPB	WSON	NGN	8	4500	367.0	367.0	35.0
LM1117MP-1.8/NOPB	SOT-223	DCY	4	1000	367.0	367.0	35.0
LM1117MP-2.5/NOPB	SOT-223	DCY	4	1000	367.0	367.0	35.0
LM1117MP-3.3/NOPB	SOT-223	DCY	4	1000	367.0	367.0	35.0
LM1117MP-5.0/NOPB	SOT-223	DCY	4	1000	367.0	367.0	35.0
LM1117MP-ADJ/NOPB	SOT-223	DCY	4	1000	367.0	367.0	35.0
LM1117MPX-1.8/NOPB	SOT-223	DCY	4	2000	367.0	367.0	35.0
LM1117MPX-2.5/NOPB	SOT-223	DCY	4	2000	367.0	367.0	35.0
LM1117MPX-3.3	SOT-223	DCY	4	2000	367.0	367.0	35.0
LM1117MPX-3.3/NOPB	SOT-223	DCY	4	2000	367.0	367.0	35.0
LM1117MPX-5.0/NOPB	SOT-223	DCY	4	2000	367.0	367.0	35.0
LM1117MPX-ADJ/NOPB	SOT-223	DCY	4	2000	367.0	367.0	35.0
LM1117SX-3.3/NOPB	DDPAK/TO-263	KTT	3	500	367.0	367.0	45.0
LM1117SX-5.0/NOPB	DDPAK/TO-263	KTT	3	500	367.0	367.0	45.0
LM1117SX-ADJ/NOPB	DDPAK/TO-263	KTT	3	500	367.0	367.0	45.0

NDE0003B



KTT0003B

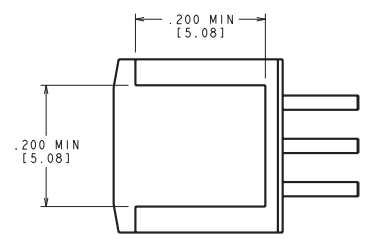
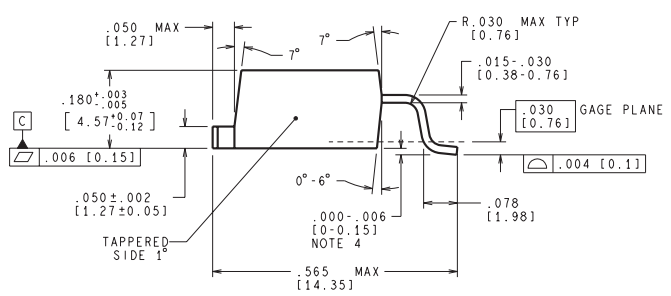
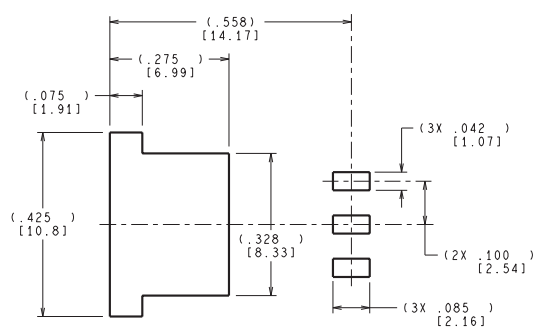
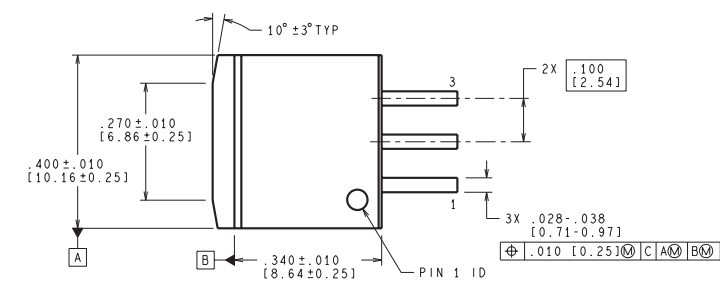

BOTTOM SIDE OF PACKAGE

CONTROLLING DIMENSION IS INCH  
 VALUES IN [ ] ARE MILLIMETERS  
 DIMENSIONS IN ( ) FOR REFERENCE ONLY

TS3B (Rev F)

DCY (R-PDSO-G4)

PLASTIC SMALL-OUTLINE



- NOTES: A. All linear dimensions are in millimeters (inches).  
 B. This drawing is subject to change without notice.  
 C. Body dimensions do not include mold flash or protrusion.  
 D. Falls within JEDEC TO-261 Variation AA.

DCY (R-PDSO-G4)

PLASTIC SMALL OUTLINE



- NOTES:
- A. All linear dimensions are in millimeters.
  - B. This drawing is subject to change without notice.
  - C. Publication IPC-7351 is recommended for alternate designs.
  - D. Laser cutting apertures with trapezoidal walls and also rounding corners will offer better paste release. Customers should contact their board assembly site for stencil recommendations. Refer to IPC 7525 for stencil design considerations.



# EXAMPLE BOARD LAYOUT

**NDP0003B**

**TO-252 - 2.55 mm max height**

TRANSISTOR OUTLINE



LAND PATTERN EXAMPLE  
EXPOSED METAL SHOWN  
SCALE: 8X



SOLDER MASK DETAIL

4219870/A 03/2018

NOTES: (continued)

4. This package is designed to be soldered to a thermal pad on the board. For more information, see Texas Instruments literature numbers SLMA002([www.ti.com/lit/slm002](http://www.ti.com/lit/slm002)) and SLMA004 ([www.ti.com/lit/slma004](http://www.ti.com/lit/slma004)).
5. Vias are optional depending on application, refer to device data sheet. It is recommended that vias under paste be filled, plugged or tented.

# EXAMPLE STENCIL DESIGN

NDP0003B

TO-252 - 2.55 mm max height

TRANSISTOR OUTLINE



SOLDER PASTE EXAMPLE  
BASED ON 0.125 MM THICK STENCIL  
SCALE: 8X

4219870/A 03/2018

NOTES: (continued)

6. Laser cutting apertures with trapezoidal walls and rounded corners may offer better paste release. IPC-7525 may have alternate design recommendations.
7. Board assembly site may have different recommendations for stencil design.



## IMPORTANT NOTICE AND DISCLAIMER

TI PROVIDES TECHNICAL AND RELIABILITY DATA (INCLUDING DATASHEETS), DESIGN RESOURCES (INCLUDING REFERENCE DESIGNS), APPLICATION OR OTHER DESIGN ADVICE, WEB TOOLS, SAFETY INFORMATION, AND OTHER RESOURCES "AS IS" AND WITH ALL FAULTS, AND DISCLAIMS ALL WARRANTIES, EXPRESS AND IMPLIED, INCLUDING WITHOUT LIMITATION ANY IMPLIED WARRANTIES OF MERCHANTABILITY, FITNESS FOR A PARTICULAR PURPOSE OR NON-INFRINGEMENT OF THIRD PARTY INTELLECTUAL PROPERTY RIGHTS.

These resources are intended for skilled developers designing with TI products. You are solely responsible for (1) selecting the appropriate TI products for your application, (2) designing, validating and testing your application, and (3) ensuring your application meets applicable standards, and any other safety, security, or other requirements. These resources are subject to change without notice. TI grants you permission to use these resources only for development of an application that uses the TI products described in the resource. Other reproduction and display of these resources is prohibited. No license is granted to any other TI intellectual property right or to any third party intellectual property right. TI disclaims responsibility for, and you will fully indemnify TI and its representatives against, any claims, damages, costs, losses, and liabilities arising out of your use of these resources.

TI's products are provided subject to TI's Terms of Sale ([www.ti.com/legal/termsofsale.html](http://www.ti.com/legal/termsofsale.html)) or other applicable terms available either on [ti.com](http://ti.com) or provided in conjunction with such TI products. TI's provision of these resources does not expand or otherwise alter TI's applicable warranties or warranty disclaimers for TI products.

Mailing Address: Texas Instruments, Post Office Box 655303, Dallas, Texas 75265  
Copyright © 2019, Texas Instruments Incorporated

## Looking for pricing, stock, or lifecycle information?

Click below to explore more details on WIN SOURCE:

 [View LM1117IDT-3.3 on WIN SOURCE](#)

 [Texas Instruments](#) Information

## Optimize Your Supply Chain with WIN SOURCE Solutions

-  Global Sourcing Solution
-  Obsolete Management
-  Cost Control Management
-  Shortage Management
-  Alternative Solution
-  Excess Inventory Management