



**THE DATASHEET OF  
LM2731XMFx/NOPB**



## LM2731 0.6/1.6-MHz Boost Converters With 22-V Internal FET Switch in SOT-23

### 1 Features

- 22-V DMOS FET Switch
- 1.6-MHz (X Option), 0.6-MHz (Y Option) Switching Frequency
- Low  $R_{DS(ON)}$  DMOS FET
- Switch Current Up to 1.8 A
- Wide Input Voltage Range (2.7 V to 14 V)
- Low Shutdown Current (<1  $\mu$ A)
- 5-Lead SOT-23 Package
- Uses Tiny Capacitors and Inductors
- Cycle-by-Cycle Current Limiting
- Internally Compensated

### 2 Applications

- White LED Current Sources
- PDAs and Palm-Top Computers
- Digital Cameras
- Portable Phones and Games
- Local Boost Regulators

### 3 Description

The LM2731 switching regulators are current-mode boost converters operating at fixed frequencies of 1.6 MHz (X option) and 600 kHz (Y option).

The use of SOT-23 package, made possible by the minimal power loss of the internal 1.8-A switch, and use of small inductors and capacitors result in the highest power density of the industry. The 22-V internal switch makes these solutions perfect for boosting to voltages up to 20 V.

These parts have a logic-level shutdown pin that can reduce quiescent current and extend battery life.

Protection is provided through cycle-by-cycle current limiting and thermal shutdown. Internal compensation simplifies design and reduces component count.

#### Device Information<sup>(1)</sup>

PART NUMBER	PACKAGE	BODY SIZE (NOM)
LM2731	SOT-23 (5)	1.60 mm x 2.90 mm

(1) For all available packages, see the orderable addendum at the end of the data sheet.

#### Block Diagram

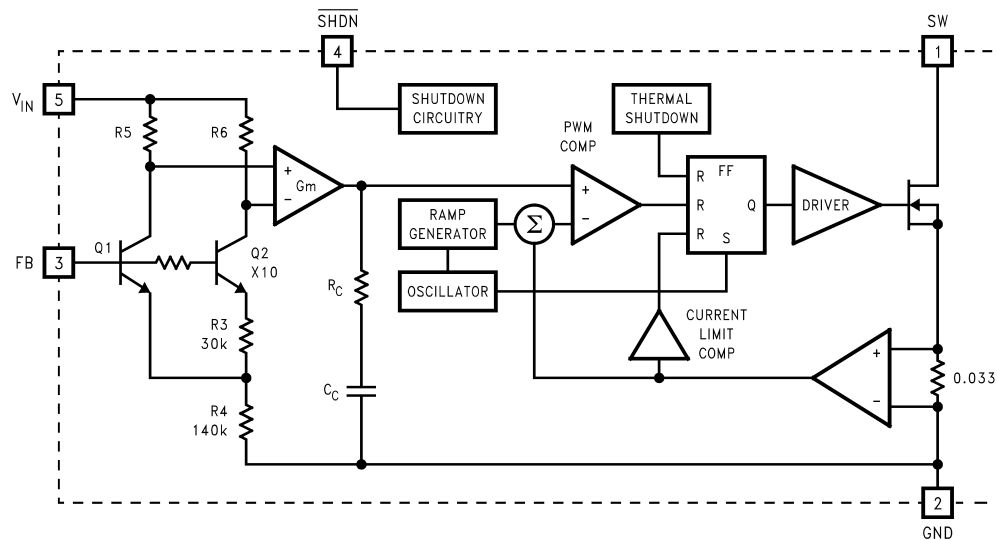

## Table of Contents

<b>1 Features</b> ..... 1 <b>2 Applications</b> ..... 1 <b>3 Description</b> ..... 1 <b>4 Revision History</b> ..... 2 <b>5 Pin Configuration and Functions</b> ..... 3 <b>6 Specifications</b> ..... 3 6.1 Absolute Maximum Ratings ..... 3 6.2 ESD Ratings..... 3 6.3 Recommended Operating Conditions ..... 4 6.4 Thermal Information ..... 4 6.5 Electrical Characteristics..... 5 6.6 Typical Characteristics ..... 7 <b>7 Detailed Description</b> ..... 11 7.1 Overview ..... 11 7.2 Functional Block Diagram ..... 11 7.3 Feature Description..... 11 7.4 Device Functional Modes..... 12	<b>8 Application and Implementation</b> ..... 13 8.1 Application Information..... 13 8.2 Typical Application ..... 13 8.3 System Examples ..... 18 <b>9 Power Supply Recommendations</b> ..... 20 <b>10 Layout</b> ..... 20 10.1 Layout Guidelines ..... 20 10.2 Layout Example ..... 20 10.3 Thermal Considerations ..... 21 <b>11 Device and Documentation Support</b> ..... 22 11.1 Device Support..... 22 11.2 Community Resources..... 22 11.3 Trademarks ..... 22 11.4 Electrostatic Discharge Caution..... 22 11.5 Glossary ..... 22 <b>12 Mechanical, Packaging, and Orderable Information</b> ..... 22
---	--

## 4 Revision History

NOTE: Page numbers for previous revisions may differ from page numbers in the current version.

Changes from Revision F (November 2012) to Revision G	Page
<ul style="list-style-type: none"> <li>• Added <i>ESD Ratings</i> table, <i>Feature Description</i> section, <i>Device Functional Modes</i>, <i>Application and Implementation</i> section, <i>Power Supply Recommendations</i> section, <i>Layout</i> section, <i>Device and Documentation Support</i> section, and <i>Mechanical, Packaging, and Orderable Information</i> section. ....</li> </ul>	1

## 5 Pin Configuration and Functions

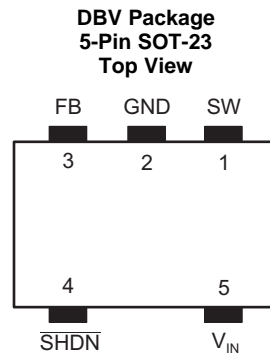

### Pin Functions

PIN		I/O	DESCRIPTION
NAME	NO.		
FB	3	I	Feedback point that connects to external resistive divider.
GND	2	PWR	Analog and power ground
$\overline{\text{SHDN}}$	4	I	Shutdown control input. Connect to $V_{\text{IN}}$ if the feature is not used.
SW	1	O	Drain of the internal FET switch
$V_{\text{IN}}$	5	PWR	Analog and power input

## 6 Specifications

### 6.1 Absolute Maximum Ratings<sup>(1)</sup>

	MIN	MAX	UNIT
Operating Junction Temperature	-40	125	°C
Lead Temperature (Soldering, 5 sec.)		300	°C
Power Dissipation <sup>(2)</sup>	Internally Limited		
FB Pin Voltage	-0.4	6	V
SW Pin Voltage	-0.4	22	V
Input Supply Voltage	-0.4	14.5	V
$\overline{\text{SHDN}}$ Pin Voltage	-0.4	$V_{\text{IN}} + 0.3$	V
Storage Temperature, $T_{\text{stg}}$	-65	150	°C

- (1) Stresses beyond those listed under *Absolute Maximum Ratings* may cause permanent damage to the device. These are stress ratings only, which do not imply functional operation of the device at these or any other conditions beyond those indicated under *Recommended Operating Conditions*. Exposure to absolute-maximum-rated conditions for extended periods may affect device reliability.
- (2) The maximum power dissipation which can be safely dissipated for any application is a function of the maximum junction temperature,  $T_{\text{J}}(\text{MAX}) = 125^{\circ}\text{C}$ , the junction-to-ambient thermal resistance for the SOT-23 package,  $R_{\theta\text{JA}} = 265^{\circ}\text{C}/\text{W}$ , and the ambient temperature,  $T_{\text{A}}$ . The maximum allowable power dissipation at any ambient temperature for designs using this device can be calculated using the

$$P(\text{MAX}) = \frac{T_{\text{J}}(\text{MAX}) - T_{\text{A}}}{\theta_{\text{J-A}}} = \frac{125 - T_{\text{A}}}{265}$$

formula:  $\theta_{\text{J-A}}$ . If power dissipation exceeds the maximum specified above, the internal thermal protection circuitry will protect the device by reducing the output voltage as required to maintain a safe junction temperature.

### 6.2 ESD Ratings

	VALUE	UNIT
$V_{\text{(ESD)}}$ Electrostatic discharge Human body model (HBM), per ANSI/ESDA/JEDEC JS-001 <sup>(1)(2)</sup>	±2000	V

- (1) JEDEC document JEP155 states that 500-V HBM allows safe manufacturing with a standard ESD control process.
- (2) The human body model is a 100-pF capacitor discharged through a 1.5-k $\Omega$  resistor into each pin.

### 6.3 Recommended Operating Conditions

over operating free-air temperature range (unless otherwise noted)

		MIN	NOM	MAX	UNIT
$V_{IN}$	Input Supply Voltage	2.7		14	V
$V_{sw}$	SW Pin Voltage	3		20	V
$V_{shdn}$	Shutdown Supply Voltage <sup>(1)</sup>	0		$V_{IN}$	V
$T_J$	Junction Temperature Range	-40		125	°C

 (1) This pin should not be allowed to float or be greater than  $V_{IN} + 0.3$  V.

### 6.4 Thermal Information

THERMAL METRIC <sup>(1)</sup>		LM2731	UNIT
		DBV (SOT-23)	
		5 PINS	
$R_{\theta JA}$	Junction-to-ambient thermal resistance	209.9	°C/W
$R_{\theta JC(top)}$	Junction-to-case (top) thermal resistance	122	°C/W
$R_{\theta JB}$	Junction-to-board thermal resistance	38.4	°C/W
$\psi_{JT}$	Junction-to-top characterization parameter	12.8	°C/W
$\psi_{JB}$	Junction-to-board characterization parameter	37.5	°C/W
$R_{\theta JC(bot)}$	Junction-to-case (bottom) thermal resistance	N/A	°C/W

 (1) For more information about traditional and new thermal metrics, see the *Semiconductor and IC Package Thermal Metrics* application report, [SPRA953](#).

## 6.5 Electrical Characteristics

Limits are for  $T_J = 25^\circ\text{C}$ . Unless otherwise specified:  $V_{IN} = 5\text{ V}$ ,  $V_{SHDN} = 5\text{ V}$ ,  $I_L = 0\text{ A}$ .

PARAMETER	TEST CONDITIONS	MIN <sup>(1)</sup>	TYP <sup>(2)</sup>	MAX <sup>(1)</sup>	UNIT		
$V_{IN}$	Input Voltage	$-40^\circ\text{C} \leq T_J \leq 125^\circ\text{C}$		2.7	14	V	
$V_{OUT(MIN)}$	Minimum Output Voltage Under Load	$R_L = 43\ \Omega$ X Option <sup>(3)</sup>	$V_{IN} = 2.7\text{ V}$	7		V	
			$-40^\circ\text{C} \leq T_J \leq 125^\circ\text{C}$	5.4			
			$V_{IN} = 3.3\text{ V}$	10			
			$-40^\circ\text{C} \leq T_J \leq 125^\circ\text{C}$	8			
			$V_{IN} = 5\text{ V}$	16			
			$R_L = 43\ \Omega$ Y Option <sup>(3)</sup>	$V_{IN} = 2.7\text{ V}$	7.5		
				$-40^\circ\text{C} \leq T_J \leq 125^\circ\text{C}$	6		
				$V_{IN} = 3.3\text{ V}$	11		
		$-40^\circ\text{C} \leq T_J \leq 125^\circ\text{C}$		8.75			
		$R_L = 15\ \Omega$ X Option <sup>(3)</sup>	$V_{IN} = 2.7\text{ V}$	5			
			$-40^\circ\text{C} \leq T_J \leq 125^\circ\text{C}$	3.75			
			$V_{IN} = 3.3\text{ V}$	6.5			
			$-40^\circ\text{C} \leq T_J \leq 125^\circ\text{C}$	5			
			$V_{IN} = 5\text{ V}$	10			
			$R_L = 15\ \Omega$ Y Option <sup>(3)</sup>	$V_{IN} = 2.7\text{ V}$	5		
				$-40^\circ\text{C} \leq T_J \leq 125^\circ\text{C}$	4		
$V_{IN} = 3.3\text{ V}$	7						
$-40^\circ\text{C} \leq T_J \leq 125^\circ\text{C}$	5.5						
$I_{SW}$	Switch Current Limit	See <sup>(4)</sup>	$T_J = 25^\circ\text{C}$	1.8	2	A	
			$-40^\circ\text{C} \leq T_J \leq 125^\circ\text{C}$	1.4			
$R_{DS(ON)}$	Switch ON-Resistance	$I_{SW} = 100\text{ mA}$ $V_{IN} = 5\text{ V}$	$T_J = 25^\circ\text{C}$	260	400	m $\Omega$	
			$-40^\circ\text{C} \leq T_J \leq 125^\circ\text{C}$	500			
		$I_{SW} = 100\text{ mA}$ $V_{IN} = 3.3\text{ V}$	$T_J = 25^\circ\text{C}$	300	450		
			$-40^\circ\text{C} \leq T_J \leq 125^\circ\text{C}$	550			
$SHDN_{TH}$	Shutdown Threshold	Device ON	$-40^\circ\text{C} \leq T_J \leq 125^\circ\text{C}$	1.5		V	
		Device OFF	$-40^\circ\text{C} \leq T_J \leq 125^\circ\text{C}$	0.5			
$I_{SHDN}$	Shutdown Pin Bias Current	$V_{SHDN} = 0$		0		$\mu\text{A}$	
		$V_{SHDN} = 5\text{ V}$	$T_J = 25^\circ\text{C}$	0			
			$-40^\circ\text{C} \leq T_J \leq 125^\circ\text{C}$	2			
$V_{FB}$	Feedback Pin Reference Voltage	$V_{IN} = 3\text{ V}$	$T_J = 25^\circ\text{C}$	1.230		V	
			$-40^\circ\text{C} \leq T_J \leq 125^\circ\text{C}$	1.205	1.255		
$I_{FB}$	Feedback Pin Bias Current	$V_{FB} = 1.23\text{ V}$	$T_J = 25^\circ\text{C}$	60		nA	
			$-40^\circ\text{C} \leq T_J \leq 125^\circ\text{C}$	500			

(1) Limits are ensured by testing, statistical correlation, or design.

(2) Typical values are derived from the mean value of a large quantity of samples tested during characterization and represent the most likely expected value of the parameter at room temperature.

(3)  $L = 10\ \mu\text{H}$ ,  $C_{OUT} = 4.7\ \mu\text{F}$ , duty cycle = maximum

(4) Switch current limit is dependent on duty cycle (see [Typical Characteristics](#)).

**Electrical Characteristics (continued)**

 Limits are for  $T_J = 25^\circ\text{C}$ . Unless otherwise specified:  $V_{IN} = 5\text{ V}$ ,  $V_{SHDN} = 5\text{ V}$ ,  $I_L = 0\text{ A}$ .

PARAMETER		TEST CONDITIONS		MIN <sup>(1)</sup>	TYP <sup>(2)</sup>	MAX <sup>(1)</sup>	UNIT
$I_Q$	Quiescent Current	$V_{SHDN} = 5\text{ V}$ , Switching "X"	$T_J = 25^\circ\text{C}$		2		mA
			$-40^\circ\text{C} \leq T_J \leq 125^\circ\text{C}$			3	
		$V_{SHDN} = 5\text{ V}$ , Switching "Y"	$T_J = 25^\circ\text{C}$		1		
			$-40^\circ\text{C} \leq T_J \leq 125^\circ\text{C}$				2
		$V_{SHDN} = 5\text{ V}$ , Not Switching	$T_J = 25^\circ\text{C}$			400	
$-40^\circ\text{C} \leq T_J \leq 125^\circ\text{C}$					500		
		$V_{SHDN} = 0$			0.024	1	
$\Delta V_{FB}/\Delta V_{IN}$	FB Voltage Line Regulation	$2.7\text{ V} \leq V_{IN} \leq 14\text{ V}$			0.02		%/V
$F_{SW}$	Switching Frequency <sup>(5)</sup>	"X" Option	$T_J = 25^\circ\text{C}$		1.6		MHz
			$-40^\circ\text{C} \leq T_J \leq 125^\circ\text{C}$		1	1.85	
		"Y" Option	$T_J = 25^\circ\text{C}$		0.6		
			$-40^\circ\text{C} \leq T_J \leq 125^\circ\text{C}$		0.4	0.8	
$D_{MAX}$	Maximum Duty Cycle <sup>(5)</sup>	"X" Option	$T_J = 25^\circ\text{C}$		86%		
			$-40^\circ\text{C} \leq T_J \leq 125^\circ\text{C}$		78%		
		"Y" Option	$T_J = 25^\circ\text{C}$		93%		
			$-40^\circ\text{C} \leq T_J \leq 125^\circ\text{C}$		88%		
$I_L$	Switch Leakage	Not Switching $V_{SW} = 5\text{ V}$				1	$\mu\text{A}$

 (5) Specified limits are the same for  $V_{in} = 3.3\text{ V}$  input.

## 6.6 Typical Characteristics

Unless otherwise specified:  $V_{IN} = 5\text{ V}$ ,  $\overline{\text{SHDN}}$  pin tied to  $V_{IN}$ .

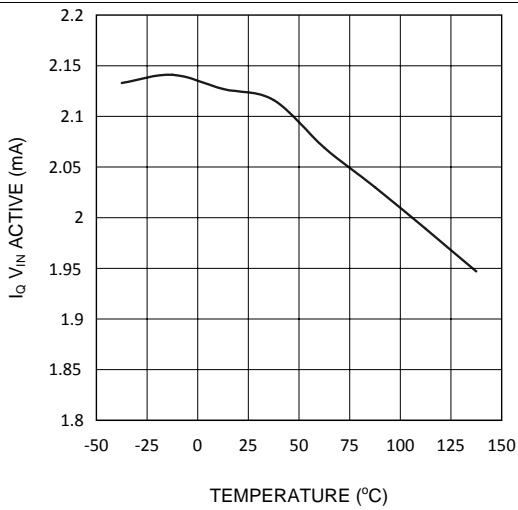

Figure 1.  $I_{q\ V_{IN}}$  (Active) vs Temperature - X Option

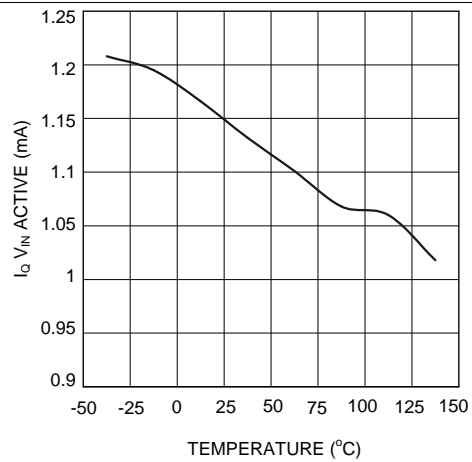

Figure 2.  $I_{q\ V_{IN}}$  (Active) vs Temperature - Y Option

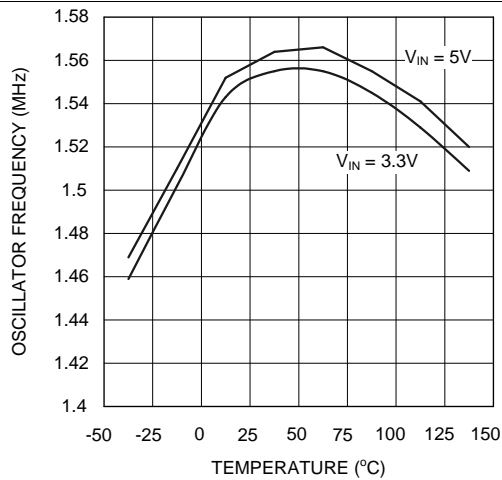

Figure 3. Oscillator Frequency vs Temperature - X Option

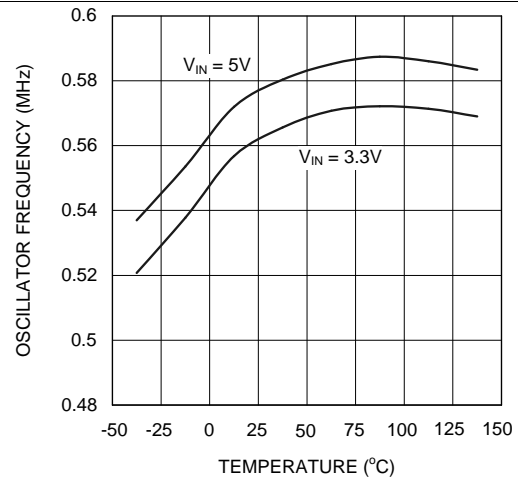

Figure 4. Oscillator Frequency vs Temperature - Y Option

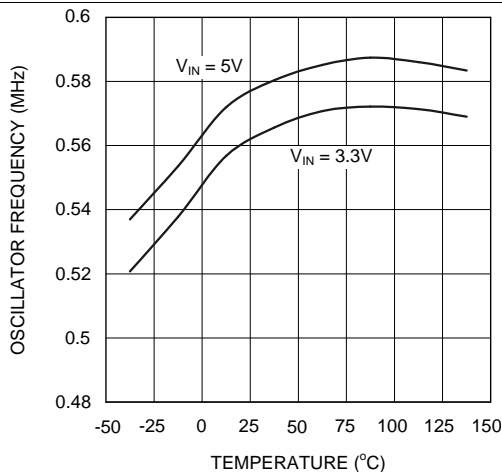

Figure 5. Maximum Duty Cycle vs Temperature - X Option

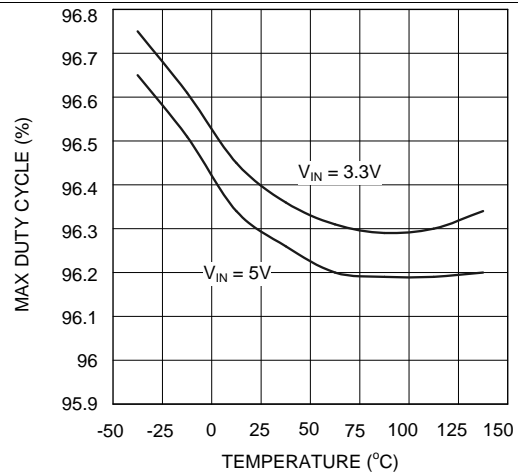

Figure 6. Maximum Duty Cycle vs Temperature - Y Option

### Typical Characteristics (continued)

Unless otherwise specified:  $V_{IN} = 5\text{ V}$ ,  $\overline{\text{SHDN}}$  pin tied to  $V_{IN}$ .

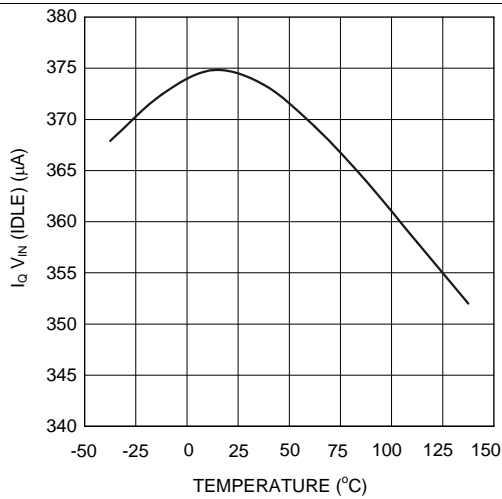

Figure 7.  $I_{q, V_{IN}}$  (Idle) vs Temperature

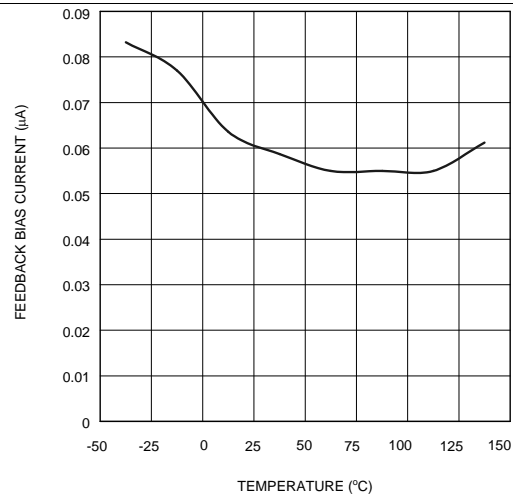

Figure 8. Feedback Bias Current vs Temperature

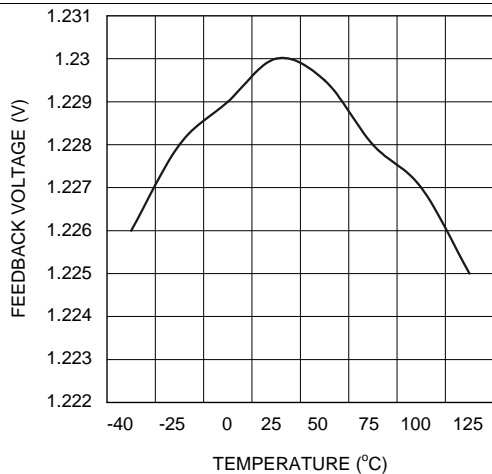

Figure 9. Feedback Voltage vs Temperature

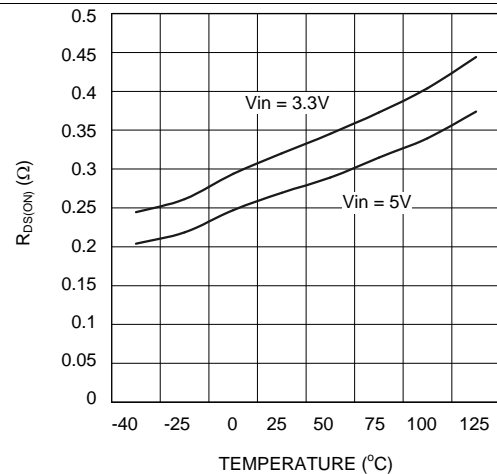

Figure 10.  $R_{DS(ON)}$  vs Temperature

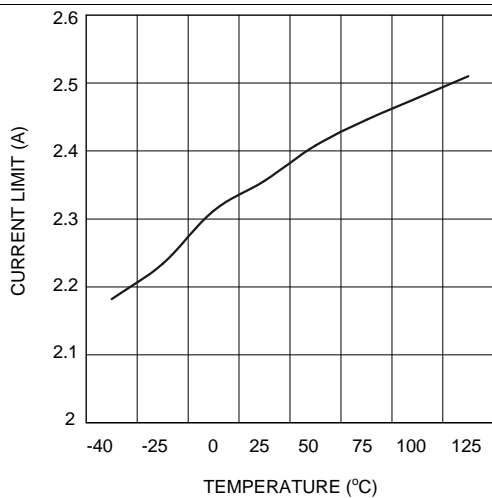

Figure 11. Current Limit vs Temperature

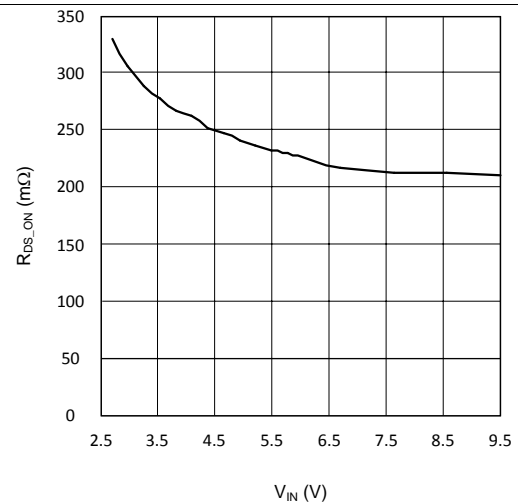

Figure 12.  $R_{DS(ON)}$  vs  $V_{IN}$

Typical Characteristics (continued)

Unless otherwise specified:  $V_{IN} = 5\text{ V}$ ,  $\overline{\text{SHDN}}$  pin tied to  $V_{IN}$ .

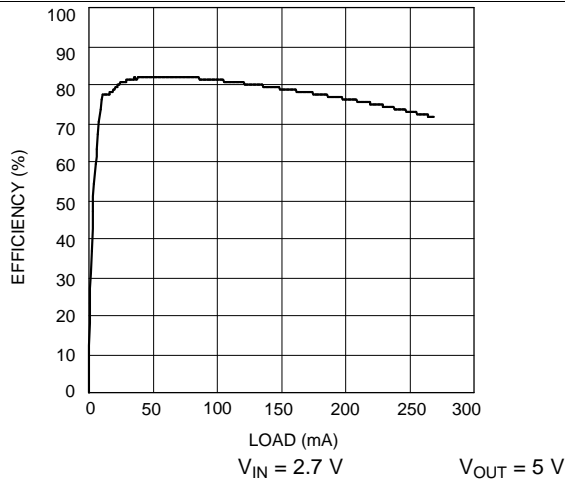

Figure 13. Efficiency vs Load Current - X Option

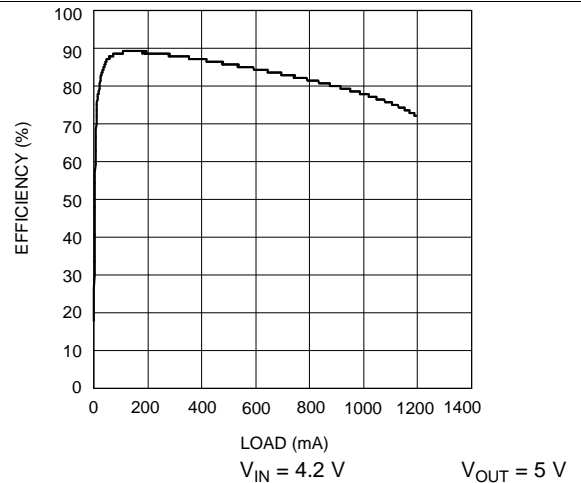

Figure 14. Efficiency vs Load Current - X Option

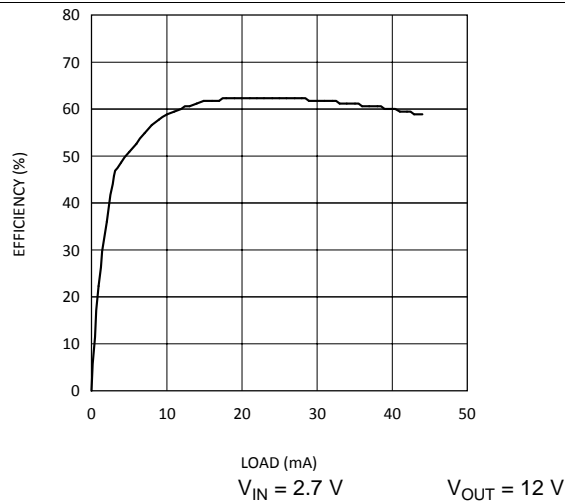

Figure 15. Efficiency vs Load Current - X Option

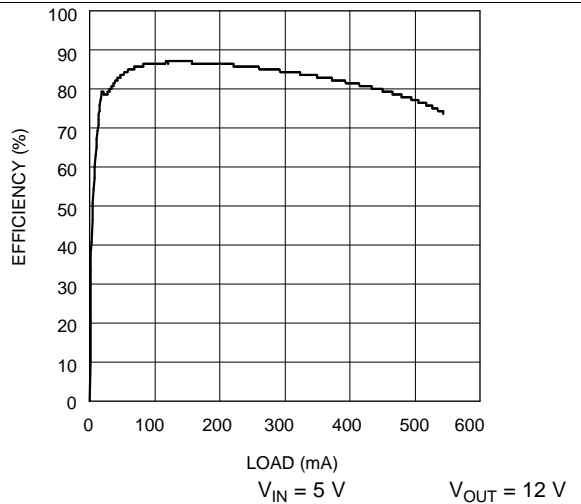

Figure 16. Efficiency vs Load Current - X Option

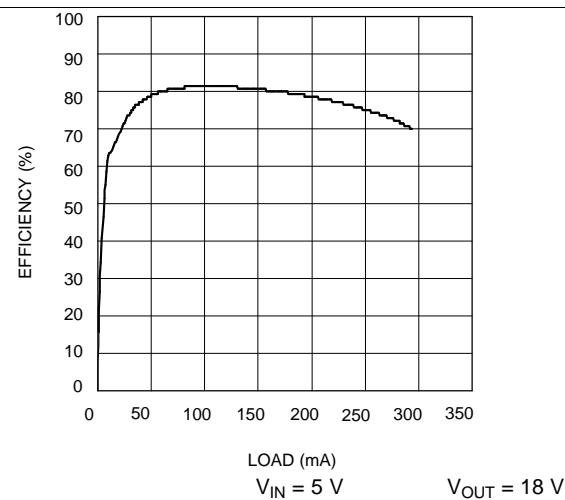

Figure 17. Efficiency vs Load Current - X Option

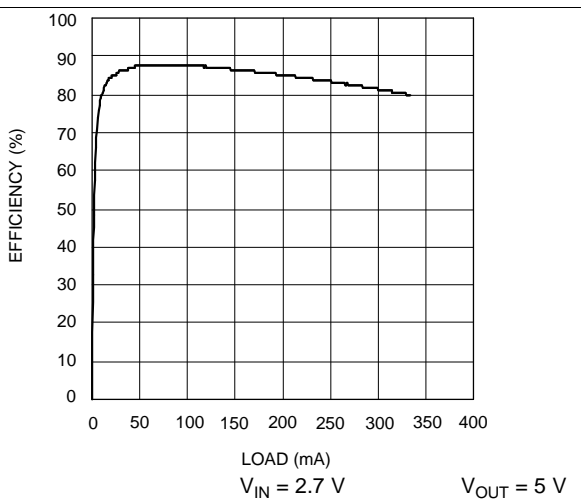

Figure 18. Efficiency vs Load Current - Y Option

### Typical Characteristics (continued)

Unless otherwise specified:  $V_{IN} = 5\text{ V}$ ,  $\overline{\text{SHDN}}$  pin tied to  $V_{IN}$ .

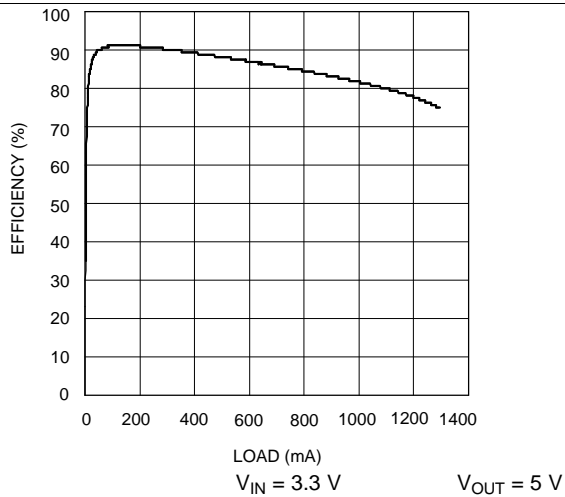

Figure 19. Efficiency vs Load Current - Y Option

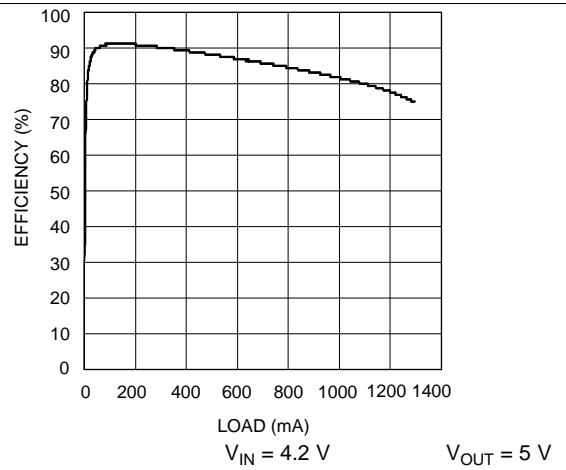

Figure 20. Efficiency vs Load Current - Y Option

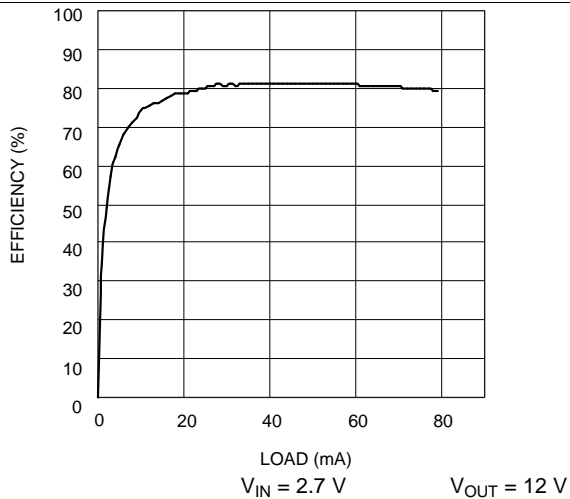

Figure 21. Efficiency vs Load Current - Y Option

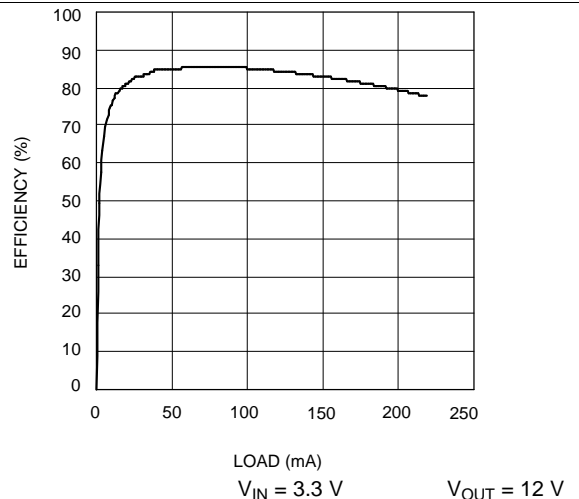

Figure 22. Efficiency vs Load Current - Y Option

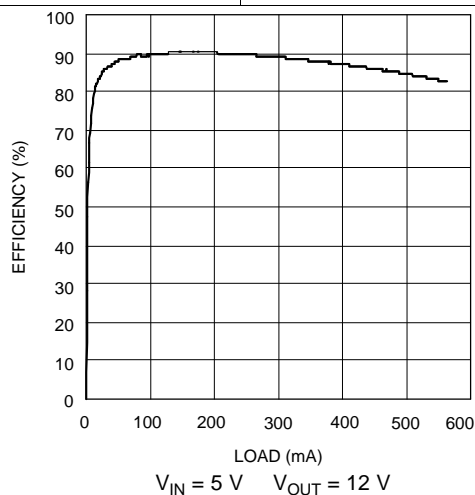

Figure 23. Efficiency vs Load Current - Y Option

## 7 Detailed Description

### 7.1 Overview

The LM2731 device is a switching converter IC that operates at a fixed frequency (0.6 or 1.6 MHz) for fast transient response over a wide input voltage range and incorporates pulse-by-pulse current limiting protection. Because this is current mode control, a 33-mΩ sense resistor in series with the switch FET is used to provide a voltage (which is proportional to the FET current) to both the input of the pulse width modulation (PWM) comparator and the current limit amplifier.

#### 7.1.1 Theory of Operation

At the beginning of each cycle, the S-R latch turns on the FET. As the current through the FET increases, a voltage (proportional to this current) is summed with the ramp coming from the ramp generator and then fed into the input of the PWM comparator. When this voltage exceeds the voltage on the other input (coming from the Gm amplifier), the latch resets and turns the FET off. Because the signal coming from the Gm amplifier is derived from the feedback (which samples the voltage at the output), the action of the PWM comparator constantly sets the correct peak current through the FET to keep the output voltage in regulation.

Q1 and Q2 along with R3 - R6 form a bandgap voltage reference used by the IC to hold the output in regulation. The currents flowing through Q1 and Q2 will be equal, and the feedback loop will adjust the regulated output to maintain this. Because of this, the regulated output is always maintained at a voltage level equal to the voltage at the FB node "multiplied up" by the ratio of the output resistive-divider.

The current limit comparator feeds directly into the flip-flop that drives the switch FET. If the FET current reaches the limit threshold, the FET is turned off and the cycle terminated until the next clock pulse. The current limit input terminates the pulse regardless of the status of the output of the PWM comparator.

### 7.2 Functional Block Diagram

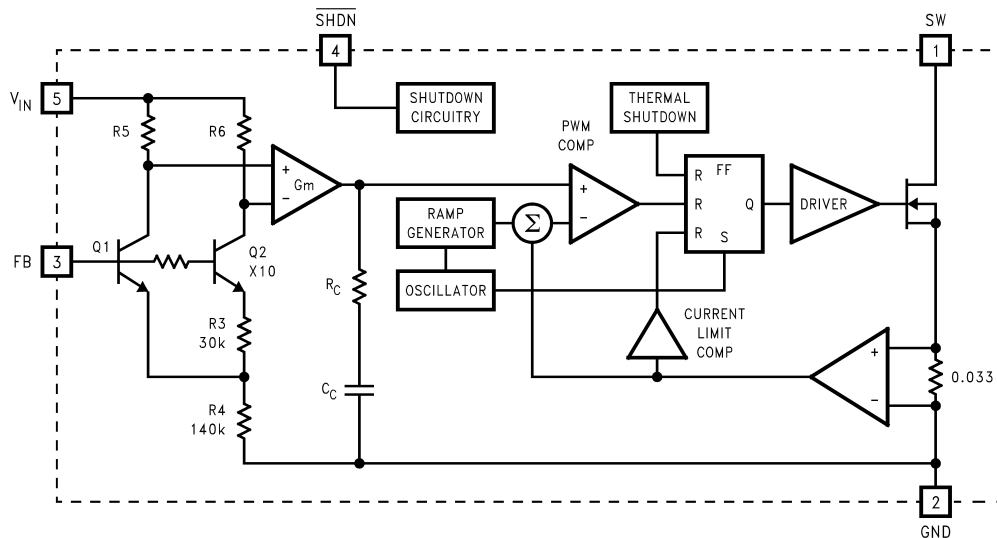

### 7.3 Feature Description

The LM2731 is a fixed-frequency boost regulator IC that delivers a minimum 1.8-A peak switch current.

The device provides cycle-by-cycle current limit protection as well as thermal shutdown protection. The device can also be controlled through the shutdown pin.

## 7.4 Device Functional Modes

### 7.4.1 Shutdown Pin Operation

The device is turned off by pulling the shutdown pin low. If this function is not going to be used, the pin should be tied directly to  $V_{IN}$ . If the SHDN function will be needed, a pullup resistor must be used to  $V_{IN}$  (approximately 50 k $\Omega$  to 100 k $\Omega$  recommended). The SHDN pin must not be left unterminated.

### 7.4.2 Thermal Shutdown

Thermal shutdown limits total power dissipation by turning off the output switch when the IC junction temperature exceeds 160°C. After thermal shutdown occurs, the output switch doesn't turn on until the junction temperature drops to approximately 150°C.

### 7.4.3 Current Limit

The LM2731 uses cycle-by-cycle current limiting to protect the internal NMOS switch. It is important to note that this current limit will not protect the output from excessive current during an output short-circuit. The input supply is connected to the output by the series connection of an inductor and a diode. If a short circuit is placed on the output, excessive current can damage both the inductor and diode.

## 8 Application and Implementation

### NOTE

Information in the following applications sections is not part of the TI component specification, and TI does not warrant its accuracy or completeness. TI's customers are responsible for determining suitability of components for their purposes. Customers should validate and test their design implementation to confirm system functionality.

### 8.1 Application Information

The device will operate with input voltage range from 2.7 V to 14 V and provide a regulated output voltage. This device is optimized for high-efficiency operation with minimum number of external components. For component selection, see [Detailed Design Procedure](#).

### 8.2 Typical Application

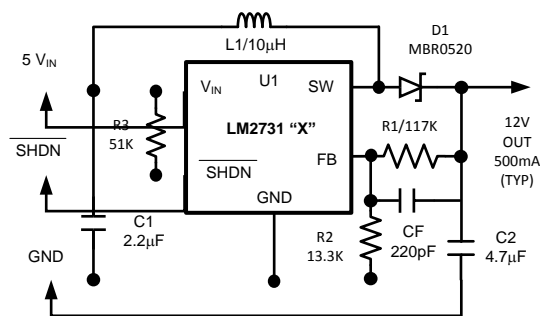

Figure 24. Application Schematic

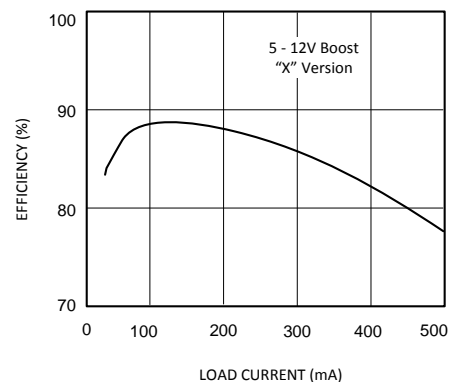

Figure 25. Efficiency vs Load Current

#### 8.2.1 Design Requirements

The device must be able to operate at any voltage within the recommended operating range. The load current must be defined in order to properly size the inductor, input, and output capacitors. The inductor must be able to handle full expected load current as well as the peak current generated during load transients and start-up. Inrush current at start-up will depend on the output capacitor selection. More details are provided in [Detailed Design Procedure](#).

The device has a shutdown pin which is used to disable the device. This pin is active-LOW and care must be taken that the voltage on this pin does not exceed  $V_{IN} + 0.3$  V. This pin must also not be left floating.

#### 8.2.2 Detailed Design Procedure

##### 8.2.2.1 Selecting the External Capacitors

The best capacitors for use with the LM2731 are multi-layer ceramic capacitors. These capacitors have the lowest ESR (equivalent series resistance) and highest resonance frequency which makes them optimum for use with high-frequency switching converters.

When selecting a ceramic capacitor, only X5R and X7R dielectric types should be used. Other types such as Z5U and Y5F have such severe loss of capacitance due to effects of temperature variation and applied voltage, they may provide as little as 20% of rated capacitance in many typical applications. Always consult capacitor manufacturer's data curves before selecting a capacitor. High-quality ceramic capacitors can be obtained from Taiyo-Yuden, AVX, and Murata.

### 8.2.2.2 Selecting the Output Capacitor

A single ceramic capacitor of value 4.7  $\mu\text{F}$  to 10  $\mu\text{F}$  will provide sufficient output capacitance for most applications. If larger amounts of capacitance are desired for improved line support and transient response, tantalum capacitors can be used. Aluminum electrolytics with ultra low ESR such as Sanyo Oscon can be used, but are usually prohibitively expensive. Typical Al electrolytic capacitors are not suitable for switching frequencies above 500 kHz due to significant ringing and temperature rise due to self-heating from ripple current. An output capacitor with excessive ESR can also reduce phase margin and cause instability.

In general, if electrolytics are used, TI recommends that they be paralleled with ceramic capacitors to reduce ringing, switching losses, and output voltage ripple.

### 8.2.2.3 Selecting the Input Capacitor

An input capacitor is required to serve as an energy reservoir for the current which must flow into the coil each time the switch turns ON. This capacitor must have extremely low ESR, so ceramic is the best choice. TI recommends a nominal value of 2.2  $\mu\text{F}$ , but larger values can be used. Since this capacitor reduces the amount of voltage ripple seen at the input pin, it also reduces the amount of EMI passed back along that line to other circuitry.

### 8.2.2.4 Feedforward Compensation

Although internally compensated, the feedforward capacitor  $C_f$  is required for stability (see [Figure 26](#)). Adding this capacitor puts a zero in the loop response of the converter. The recommended frequency for the zero  $f_z$  should be approximately 6 kHz.  $C_f$  can be calculated using the formula:

$$C_f = 1 / (2 \times \pi \times R_1 \times f_z) \quad (1)$$

### 8.2.2.5 Selecting Diodes

The external diode used in the typical application should be a Schottky diode. TI recommends a 20-V diode such as the MBR0520.

The MBR05XX series of diodes are designed to handle a maximum average current of 0.5 A. For applications exceeding 0.5-A average but less than 1 A, a Microsemi UPS5817 can be used.

### 8.2.2.6 Setting the Output Voltage

The output voltage is set using the external resistors  $R_1$  and  $R_2$  (see [Figure 26](#)). A minimum value of 13.3 k $\Omega$  is recommended for  $R_2$  to establish a divider current of approximately 92  $\mu\text{A}$ .  $R_1$  is calculated using the formula:

$$R_1 = R_2 \times (V_{\text{OUT}}/1.23 - 1) \quad (2)$$

### 8.2.2.7 Switching Frequency

The LM2731 is provided with two switching frequencies: the “X” version is typically 1.6 MHz, while the “Y” version is typically 600 kHz. The best frequency for a specific application must be determined based on the trade-offs involved:

Higher switching frequency means the inductors and capacitors can be made smaller and cheaper for a given output voltage and current. The down side is that efficiency is slightly lower because the fixed switching losses occur more frequently and become a larger percentage of total power loss. EMI is typically worse at higher switching frequencies because more EMI energy will be seen in the higher frequency spectrum where most circuits are more sensitive to such interference.

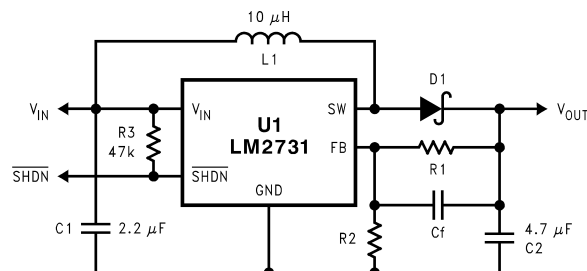

**Figure 26. Basic Application Circuit**

### 8.2.2.8 Duty Cycle

The maximum duty cycle of the switching regulator determines the maximum boost ratio of output-to-input voltage that the converter can attain in continuous mode of operation. The duty cycle for a given boost application is defined as:

$$\text{Duty Cycle} = \frac{V_{\text{OUT}} + V_{\text{DIODE}} - V_{\text{IN}}}{V_{\text{OUT}} + V_{\text{DIODE}} - V_{\text{SW}}} \quad (3)$$

This applies for continuous mode operation.

### 8.2.2.9 Inductance Value

The first question that is usually asked is: “How small can I make the inductor?” (because they are the largest sized component and usually the most costly). The answer is not simple and involves trade-offs in performance. Larger inductors mean less inductor ripple current, which typically means less output voltage ripple (for a given size of output capacitor). Larger inductors also mean more load power can be delivered because the energy stored during each switching cycle is:

$$E = L/2 \times (I_p)^2 \quad (4)$$

Where “Ip” is the peak inductor current. An important point to observe is that the LM2731 will limit its switch current based on peak current. This means that since Ip(max) is fixed, increasing L will increase the maximum amount of power available to the load. Conversely, using too little inductance may limit the amount of load current which can be drawn from the output.

Best performance is usually obtained when the converter is operated in “continuous” mode at the load current range of interest, typically giving better load regulation and less output ripple. Continuous operation is defined as not allowing the inductor current to drop to zero during the cycle. All boost converters shift over to discontinuous operation as the output load is reduced far enough, but a larger inductor stays “continuous” over a wider load current range.

To better understand these trade-offs, a typical application circuit (5-V to 12-V boost with a 10-μH inductor) will be analyzed. We will assume:

$$V_{\text{IN}} = 5 \text{ V}, V_{\text{OUT}} = 12 \text{ V}, V_{\text{DIODE}} = 0.5 \text{ V}, V_{\text{SW}} = 0.5 \text{ V} \quad (5)$$

Because the frequency is 1.6 MHz (nominal), the period is approximately 0.625 μs. The duty cycle will be 62.5%, which means the ON-time of the switch is 0.390 μs. When the switch is ON, the voltage across the inductor is approximately 4.5 V.

Using the equation:

$$V = L (di/dt) \quad (6)$$

The di/dt rate of the inductor can then be calculated, which is found to be 0.45 A/μs during the ON time. Using these facts, what the inductor current will look like during operation can be shown:

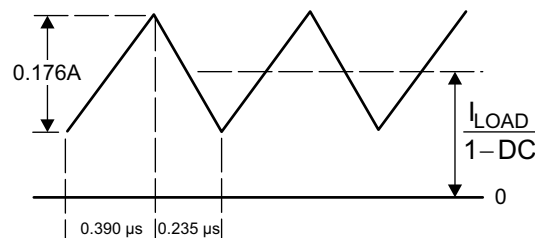
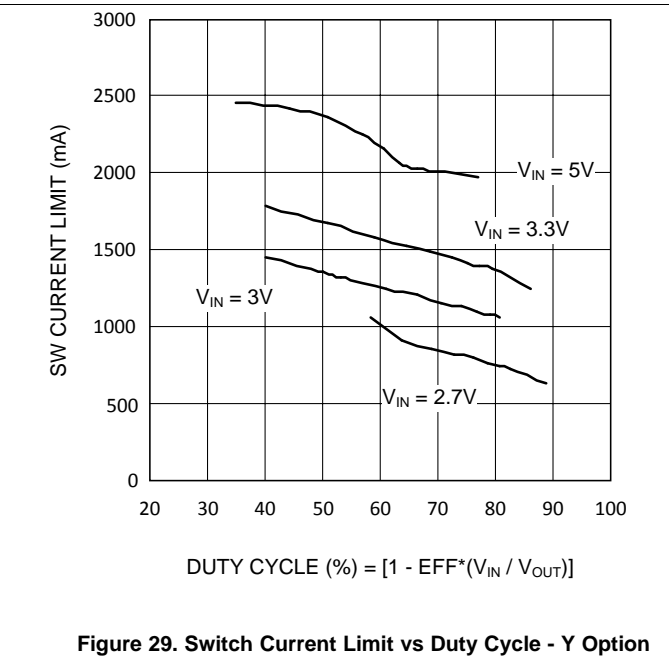
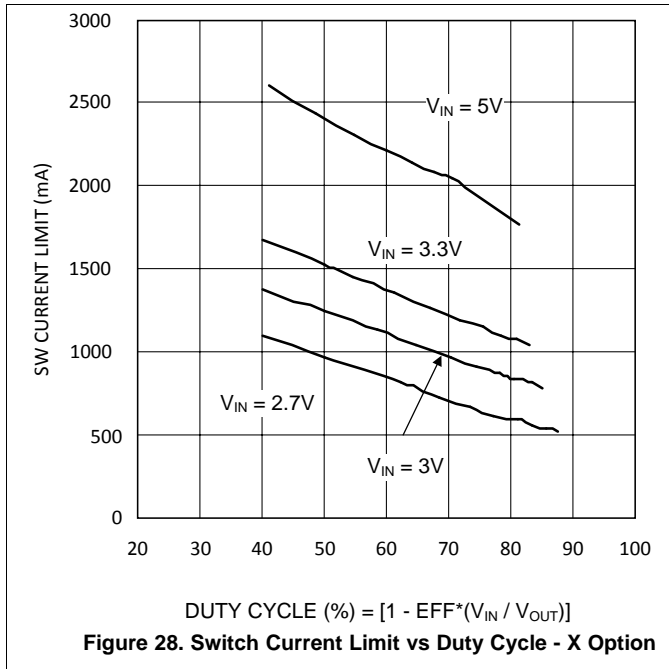

Figure 27. 10 μH Inductor Current, 5 V–12 V Boost (LM2731X)

During the 0.390-μs ON-time, the inductor current ramps up 0.176 A and ramps down an equal amount during the OFF-time. This is defined as the inductor “ripple current”. If the load current drops to about 33 mA, the inductor current will begin touching the zero axis which means it will be in discontinuous mode. A similar analysis can be performed on any boost converter, to make sure the ripple current is reasonable and continuous operation will be maintained at the typical load current values.

**8.2.2.10 Maximum Switch Current**

The maximum FET switch current available before the current limiter cuts in is dependent on duty cycle of the application. This is illustrated in the graphs below which show typical values of switch current for both the "X" and "Y" versions as a function of effective (actual) duty cycle:



**8.2.2.11 Calculating Load Current**

As shown in the figure which depicts inductor current, the load current is related to the average inductor current by the relation:

$$I_{LOAD} = I_{IND(AVG)} \times (1 - DC) \tag{7}$$

Where "DC" is the duty cycle of the application. The switch current can be found by:

$$I_{SW} = I_{IND(AVG)} + \frac{1}{2} (I_{RIPPLE}) \tag{8}$$

Inductor ripple current is dependent on inductance, duty cycle, input voltage and frequency:

$$I_{RIPPLE} = DC \times (V_{IN} - V_{SW}) / (f \times L) \tag{9}$$

Combining all terms, an expression can be developed which allows the maximum available load current to be calculated:

$$I_{LOAD(max)} = (1 - DC) \times \left( I_{SW(max)} - \frac{DC(V_{IN} - V_{SW})}{2fL} \right) \tag{10}$$

The equation shown to calculate maximum load current takes into account the losses in the inductor or turn-OFF switching losses of the FET and diode. For actual load current in typical applications, we took bench data for various input and output voltages for both the "X" and "Y" versions of the LM2731 and displayed the maximum load current available for a typical device in graph form:

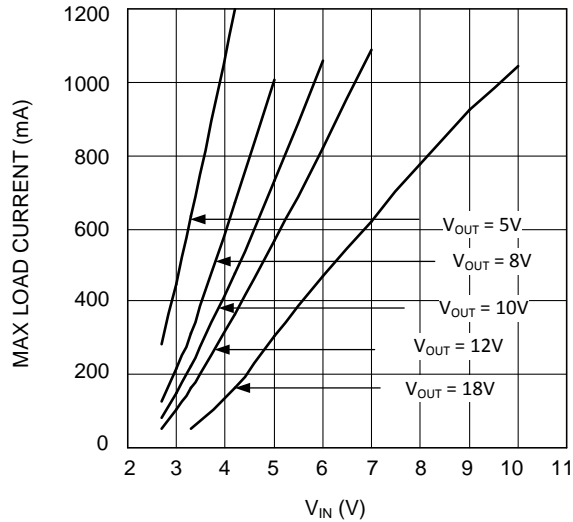

Figure 30. Maximum Load Current (Typical) vs  $V_{IN}$  - X Option

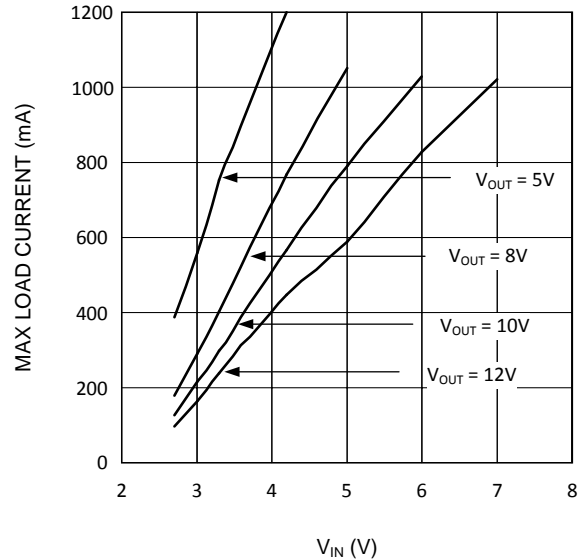

Figure 31. Maximum Load Current (Typical) vs  $V_{IN}$  - Y Option

### 8.2.2.12 Design Parameters $V_{SW}$ and $I_{SW}$

The value of the FET "ON" voltage (referred to as  $V_{SW}$  in the equations) is dependent on load current. A good approximation can be obtained by multiplying the "ON-Resistance" of the FET times the average inductor current.

FET on resistance increases at  $V_{IN}$  values less than 5 V, since the internal N-FET has less gate voltage in this input voltage range (see [Typical Characteristics](#) curves). Above  $V_{IN} = 5V$ , the FET gate voltage is internally clamped to 5V.

The maximum peak switch current the device can deliver is dependent on duty cycle. For higher duty cycles, see [Typical Characteristics](#).

### 8.2.2.13 Inductor Suppliers

Recommended suppliers of inductors for this product include, but are not limited to Sumida, Coilcraft, Panasonic, TDK, and Murata. When selecting an inductor, make certain that the continuous current rating is high enough to avoid saturation at peak currents. A suitable core type must be used to minimize core (switching) losses, and wire power losses must be considered when selecting the current rating.

LM2731

SNVS217G – MAY 2004 – REVISED SEPTEMBER 2015

www.ti.com

8.2.3 Application Curves

See [Typical Characteristics](#).

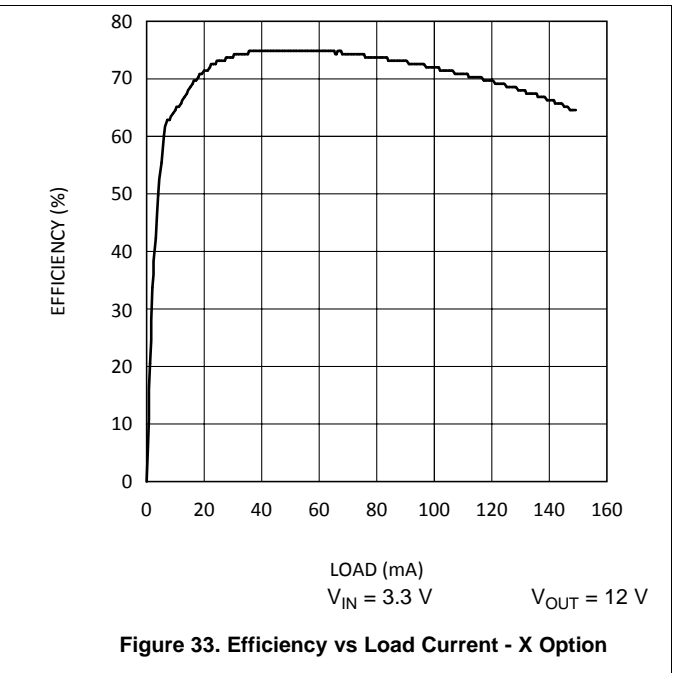
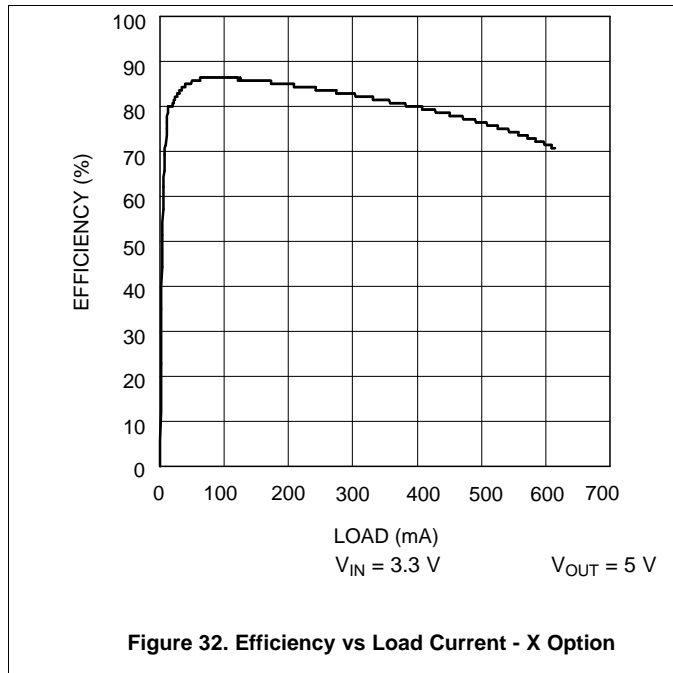

8.3 System Examples

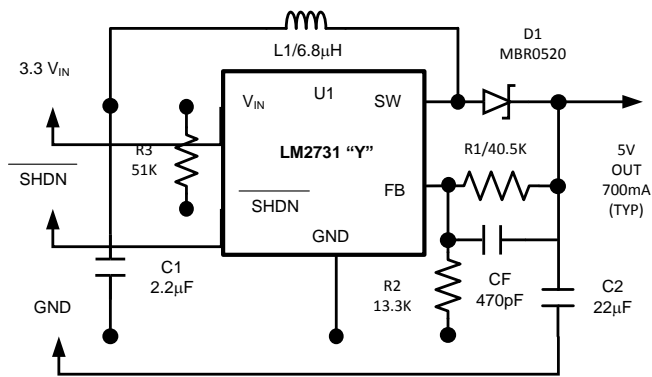

Figure 34. VIN = 3.3 V, VOUT = 5 V at 700 mA

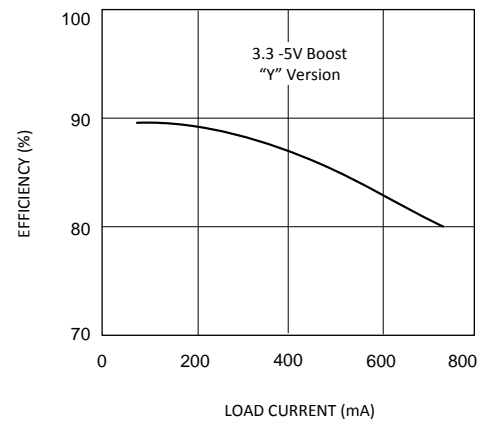

Figure 35. Efficiency vs Load Current

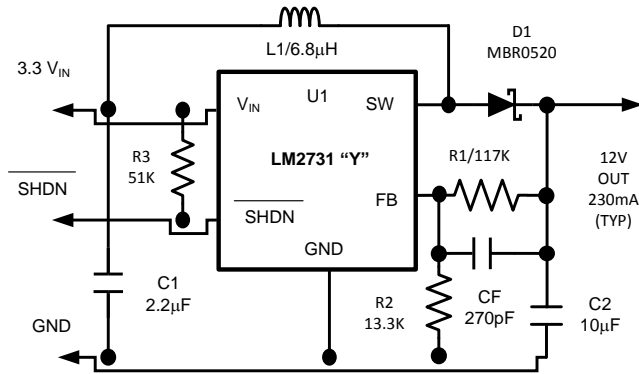

Figure 36. VIN = 3.3 V, VOUT = 12 V at 230 mA

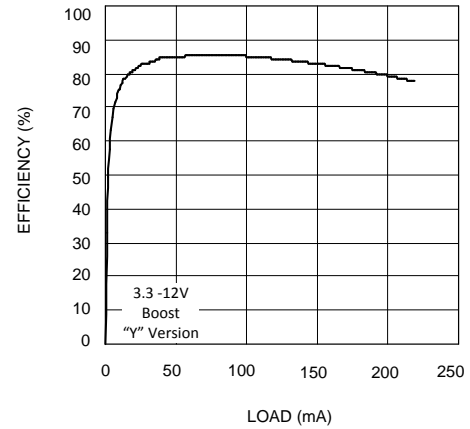

Figure 37. Efficiency vs Load Current

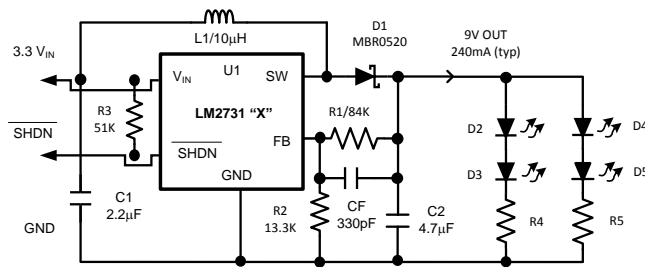

Figure 38. VIN = 3.3 V, VOUT = 9 V at 240 mA

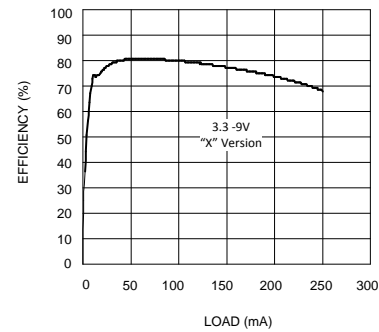

Figure 39. Efficiency vs Load Current

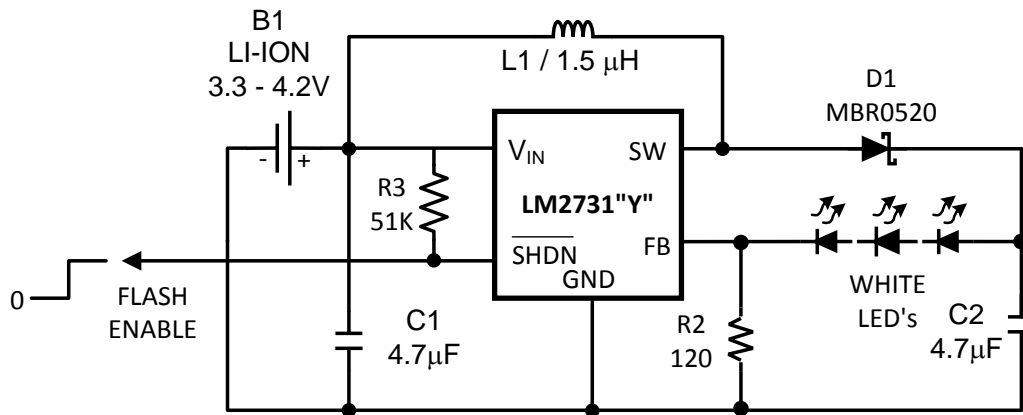

Figure 40. White LED Flash Application

## 9 Power Supply Recommendations

The LM2731 device is designed to operate from various DC power supplies. The impedance of the input supply rail should be low enough that the input current transient does not cause a drop below SHUTDOWN level. If the input supply is connected by using long wires, additional bulk capacitance may be required in addition to normal input capacitor.

## 10 Layout

### 10.1 Layout Guidelines

High-frequency switching regulators require very careful layout of components to get stable operation and low noise. All components must be as close as possible to the LM2731 device. TI recommends that a 4-layer PCB be used so that internal ground planes are available.

As an example, a recommended layout of components is shown in [Figure 41](#).

Some additional guidelines to be observed:

- Keep the path between L1, D1, and C2 extremely short. Parasitic trace inductance in series with D1 and C2 will increase noise and ringing.
- The feedback components R1, R2 and CF must be kept close to the FB pin of U1 to prevent noise injection on the FB pin trace.
- If internal ground planes are available (recommended), use vias to connect directly to ground at pin 2 of U1, as well as the negative sides of capacitors C1 and C2.

### 10.2 Layout Example

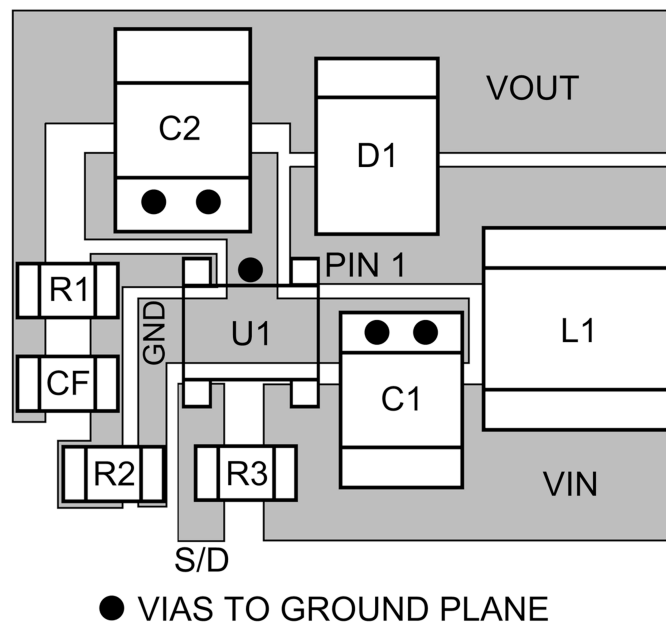

**Figure 41. Recommended PCB Component Layout**

### 10.3 Thermal Considerations

At higher duty cycles, the increased ON-time of the FET means the maximum output current will be determined by power dissipation within the LM2731 FET switch. The switch power dissipation from ON-state conduction is calculated by:

$$P_{(SW)} = DC \times I_{IND(AVE)}^2 \times R_{DS(ON)} \quad (11)$$

There will be some switching losses as well, so some derating needs to be applied when calculating IC power dissipation.

## 11 Device and Documentation Support

### 11.1 Device Support

#### 11.1.1 Third-Party Products Disclaimer

TI'S PUBLICATION OF INFORMATION REGARDING THIRD-PARTY PRODUCTS OR SERVICES DOES NOT CONSTITUTE AN ENDORSEMENT REGARDING THE SUITABILITY OF SUCH PRODUCTS OR SERVICES OR A WARRANTY, REPRESENTATION OR ENDORSEMENT OF SUCH PRODUCTS OR SERVICES, EITHER ALONE OR IN COMBINATION WITH ANY TI PRODUCT OR SERVICE.

### 11.2 Community Resources

The following links connect to TI community resources. Linked contents are provided "AS IS" by the respective contributors. They do not constitute TI specifications and do not necessarily reflect TI's views; see TI's [Terms of Use](#).

**TI E2E™ Online Community** *TI's Engineer-to-Engineer (E2E) Community*. Created to foster collaboration among engineers. At [e2e.ti.com](http://e2e.ti.com), you can ask questions, share knowledge, explore ideas and help solve problems with fellow engineers.

**Design Support** *TI's Design Support* Quickly find helpful E2E forums along with design support tools and contact information for technical support.

### 11.3 Trademarks

E2E is a trademark of Texas Instruments.  
All other trademarks are the property of their respective owners.

### 11.4 Electrostatic Discharge Caution



These devices have limited built-in ESD protection. The leads should be shorted together or the device placed in conductive foam during storage or handling to prevent electrostatic damage to the MOS gates.

### 11.5 Glossary

[SLYZ022](#) — *TI Glossary*.

This glossary lists and explains terms, acronyms, and definitions.

## 12 Mechanical, Packaging, and Orderable Information

The following pages include mechanical, packaging, and orderable information. This information is the most current data available for the designated devices. This data is subject to change without notice and revision of this document. For browser-based versions of this data sheet, refer to the left-hand navigation.

**PACKAGING INFORMATION**

Orderable Device	Status (1)	Package Type	Package Drawing	Pins	Package Qty	Eco Plan (2)	Lead/Ball Finish (6)	MSL Peak Temp (3)	Op Temp (°C)	Device Marking (4/5)	Samples
LM2731XMF	NRND	SOT-23	DBV	5	1000	TBD	Call TI	Call TI	-40 to 125	S51A	
LM2731XMF/NOPB	ACTIVE	SOT-23	DBV	5	1000	Green (RoHS & no Sb/Br)	CU SN	Level-1-260C-UNLIM	-40 to 125	S51A	
LM2731XMF/NOPB	ACTIVE	SOT-23	DBV	5	3000	Green (RoHS & no Sb/Br)	CU SN	Level-1-260C-UNLIM	-40 to 125	S51A	
LM2731YMF	ACTIVE	SOT-23	DBV	5	1000	TBD	Call TI	Call TI	-40 to 125	S51B	
LM2731YMF/NOPB	ACTIVE	SOT-23	DBV	5	1000	Green (RoHS & no Sb/Br)	CU SN	Level-1-260C-UNLIM	-40 to 125	S51B	
LM2731YMF/NOPB	ACTIVE	SOT-23	DBV	5	3000	Green (RoHS & no Sb/Br)	CU SN	Level-1-260C-UNLIM	-40 to 125	S51B	

(1) The marketing status values are defined as follows:

**ACTIVE:** Product device recommended for new designs.

**LIFEBUY:** TI has announced that the device will be discontinued, and a lifetime-buy period is in effect.

**NRND:** Not recommended for new designs. Device is in production to support existing customers, but TI does not recommend using this part in a new design.

**PREVIEW:** Device has been announced but is not in production. Samples may or may not be available.

**OBSELETE:** TI has discontinued the production of the device.

(2) Eco Plan - The planned eco-friendly classification: Pb-Free (RoHS), Pb-Free (RoHS Exempt), or Green (RoHS & no Sb/Br) - please check <http://www.ti.com/productcontent> for the latest availability information and additional product content details.

**TBD:** The Pb-Free/Green conversion plan has not been defined.

**Pb-Free (RoHS):** TI's terms "Lead-Free" or "Pb-Free" mean semiconductor products that are compatible with the current RoHS requirements for all 6 substances, including the requirement that lead not exceed 0.1% by weight in homogeneous materials. Where designed to be soldered at high temperatures, TI Pb-Free products are suitable for use in specified lead-free processes.

**Pb-Free (RoHS Exempt):** This component has a RoHS exemption for either 1) lead-based flip-chip solder bumps used between the die and package, or 2) lead-based die adhesive used between the die and leadframe. The component is otherwise considered Pb-Free (RoHS compatible) as defined above.

**Green (RoHS & no Sb/Br):** TI defines "Green" to mean Pb-Free (RoHS compatible), and free of Bromine (Br) and Antimony (Sb) based flame retardants (Br or Sb do not exceed 0.1% by weight in homogeneous material)

(3) MSL, Peak Temp. - The Moisture Sensitivity Level rating according to the JEDEC industry standard classifications, and peak solder temperature.

(4) There may be additional marking, which relates to the logo, the lot trace code information, or the environmental category on the device.

(5) Multiple Device Markings will be inside parentheses. Only one Device Marking contained in parentheses and separated by a "~" will appear on a device. If a line is indented then it is a continuation of the previous line and the two combined represent the entire Device Marking for that device.

<sup>(6)</sup> Lead/Ball Finish - Orderable Devices may have multiple material finish options. Finish options are separated by a vertical ruled line. Lead/Ball Finish values may wrap to two lines if the finish value exceeds the maximum column width.

**Important Information and Disclaimer:**The information provided on this page represents TI's knowledge and belief as of the date that it is provided. TI bases its knowledge and belief on information provided by third parties, and makes no representation or warranty as to the accuracy of such information. Efforts are underway to better integrate information from third parties. TI has taken and continues to take reasonable steps to provide representative and accurate information but may not have conducted destructive testing or chemical analysis on incoming materials and chemicals. TI and TI suppliers consider certain information to be proprietary, and thus CAS numbers and other limited information may not be available for release.

In no event shall TI's liability arising out of such information exceed the total purchase price of the TI part(s) at issue in this document sold by TI to Customer on an annual basis.

**TAPE AND REEL INFORMATION**

**QUADRANT ASSIGNMENTS FOR PIN 1 ORIENTATION IN TAPE**

\*All dimensions are nominal

Device	Package Type	Package Drawing	Pins	SPQ	Reel Diameter (mm)	Reel Width W1 (mm)	A0 (mm)	B0 (mm)	K0 (mm)	P1 (mm)	W (mm)	Pin1 Quadrant
LM2731XMF	SOT-23	DBV	5	1000	178.0	8.4	3.2	3.2	1.4	4.0	8.0	Q3
LM2731XMF/NOPB	SOT-23	DBV	5	1000	178.0	8.4	3.2	3.2	1.4	4.0	8.0	Q3
LM2731XMF/NOPB	SOT-23	DBV	5	3000	178.0	8.4	3.2	3.2	1.4	4.0	8.0	Q3
LM2731YMF	SOT-23	DBV	5	1000	178.0	8.4	3.2	3.2	1.4	4.0	8.0	Q3
LM2731YMF/NOPB	SOT-23	DBV	5	1000	178.0	8.4	3.2	3.2	1.4	4.0	8.0	Q3
LM2731YMF/NOPB	SOT-23	DBV	5	3000	178.0	8.4	3.2	3.2	1.4	4.0	8.0	Q3

**TAPE AND REEL BOX DIMENSIONS**

\*All dimensions are nominal

Device	Package Type	Package Drawing	Pins	SPQ	Length (mm)	Width (mm)	Height (mm)
LM2731XMF	SOT-23	DBV	5	1000	210.0	185.0	35.0
LM2731XMF/NOPB	SOT-23	DBV	5	1000	210.0	185.0	35.0
LM2731XMF/NOPB	SOT-23	DBV	5	3000	210.0	185.0	35.0
LM2731YMF	SOT-23	DBV	5	1000	210.0	185.0	35.0
LM2731YMF/NOPB	SOT-23	DBV	5	1000	210.0	185.0	35.0
LM2731YMF/NOPB	SOT-23	DBV	5	3000	210.0	185.0	35.0



# EXAMPLE BOARD LAYOUT

DBV0005A

SOT-23 - 1.45 mm max height

SMALL OUTLINE TRANSISTOR



LAND PATTERN EXAMPLE  
EXPOSED METAL SHOWN  
SCALE:15X

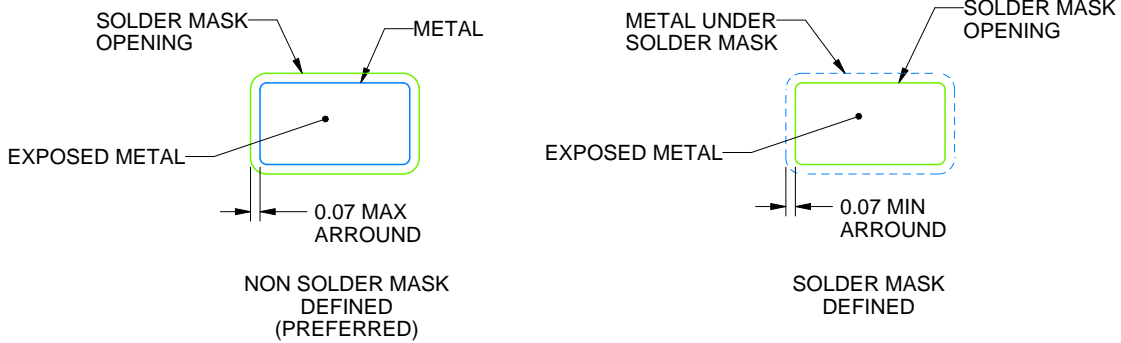

SOLDER MASK DETAILS

4214839/D 11/2018

NOTES: (continued)

- 5. Publication IPC-7351 may have alternate designs.
- 6. Solder mask tolerances between and around signal pads can vary based on board fabrication site.

# EXAMPLE STENCIL DESIGN

DBV0005A

SOT-23 - 1.45 mm max height

SMALL OUTLINE TRANSISTOR



SOLDER PASTE EXAMPLE  
BASED ON 0.125 mm THICK STENCIL  
SCALE:15X

4214839/D 11/2018

NOTES: (continued)

7. Laser cutting apertures with trapezoidal walls and rounded corners may offer better paste release. IPC-7525 may have alternate design recommendations.
8. Board assembly site may have different recommendations for stencil design.

## IMPORTANT NOTICE AND DISCLAIMER

TI PROVIDES TECHNICAL AND RELIABILITY DATA (INCLUDING DATASHEETS), DESIGN RESOURCES (INCLUDING REFERENCE DESIGNS), APPLICATION OR OTHER DESIGN ADVICE, WEB TOOLS, SAFETY INFORMATION, AND OTHER RESOURCES "AS IS" AND WITH ALL FAULTS, AND DISCLAIMS ALL WARRANTIES, EXPRESS AND IMPLIED, INCLUDING WITHOUT LIMITATION ANY IMPLIED WARRANTIES OF MERCHANTABILITY, FITNESS FOR A PARTICULAR PURPOSE OR NON-INFRINGEMENT OF THIRD PARTY INTELLECTUAL PROPERTY RIGHTS.

These resources are intended for skilled developers designing with TI products. You are solely responsible for (1) selecting the appropriate TI products for your application, (2) designing, validating and testing your application, and (3) ensuring your application meets applicable standards, and any other safety, security, or other requirements. These resources are subject to change without notice. TI grants you permission to use these resources only for development of an application that uses the TI products described in the resource. Other reproduction and display of these resources is prohibited. No license is granted to any other TI intellectual property right or to any third party intellectual property right. TI disclaims responsibility for, and you will fully indemnify TI and its representatives against, any claims, damages, costs, losses, and liabilities arising out of your use of these resources.

TI's products are provided subject to TI's Terms of Sale ([www.ti.com/legal/termsofsale.html](http://www.ti.com/legal/termsofsale.html)) or other applicable terms available either on [ti.com](http://ti.com) or provided in conjunction with such TI products. TI's provision of these resources does not expand or otherwise alter TI's applicable warranties or warranty disclaimers for TI products.

Mailing Address: Texas Instruments, Post Office Box 655303, Dallas, Texas 75265  
Copyright © 2019, Texas Instruments Incorporated

## Looking for pricing, stock, or lifecycle information?

Click below to explore more details on WIN SOURCE:

 [View LM2731XMFX/NOPB on WIN SOURCE](#)

 [Texas Instruments](#) Information

## Optimize Your Supply Chain with WIN SOURCE Solutions

-  Global Sourcing Solution
-  Obsolete Management
-  Cost Control Management
-  Shortage Management
-  Alternative Solution
-  Excess Inventory Management