



**THE DATASHEET OF
LM2853MH-1.2/NOPB**



LM2853 3-A 550-kHz Synchronous Buck Regulator

1 Features

- Input Voltage Range of 3 V to 5.5 V
- Factory EEPROM Set Output Voltages From 0.8 V to 3.3 V in 100 mV Increments
- Maximum Load Current of 3A
- Voltage Mode Control
- Internal Type-Three Compensation
- Switching Frequency of 550 kHz
- Low Standby Current of 12 μ A
- Internal 40 m Ω MOSFET Switches
- Standard Voltage Options
 - 0.8/1.0/1.2/1.5/1.8/2.5/3.0/3.3 Volts
- Exposed Pad 14-Lead HTSSOP (PWP) Package

2 Applications

- Low Voltage Point of Load Regulation
- Local Solution for FPGA/DSP/ASIC Core Power
- Broadband Networking and Communications Infrastructure

Typical Application Circuit

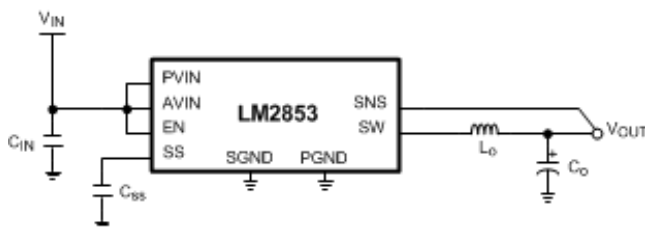

3 Description

The LM2853 synchronous buck regulator is a 550 kHz step-down switching voltage regulator capable of driving up to a 3A load with excellent line and load regulation. The LM2853 accepts an input voltage between 3 V and 5.5 V and delivers a customizable output voltage that is factory programmable from 0.8 V to 3.3 V in 100 mV increments. Internal type-three compensation enables a low component count solution and greatly simplifies external component selection. The HTSSOP-14 (PWP) package enhances the thermal performance of the LM2853.

Device Information⁽¹⁾

PART NUMBER	PACKAGE	BODY SIZE (NOM)
LM2853	HTSSOP (14)	5.00 mm x 4.40 mm

(1) For all available packages, see the orderable addendum at the end of the data sheet.

Efficiency vs I_{LOAD}

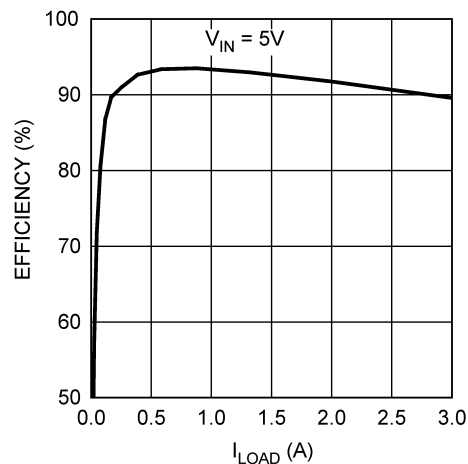

Table of Contents

1 Features	1	7.2 Functional Block Diagram	8
2 Applications	1	8 Application and Implementation	9
3 Description	1	8.1 Application Information.....	9
4 Revision History	2	8.2 Typical Application	13
5 Pin Configuration and Functions	3	9 Layout	14
6 Specifications	4	9.1 Layout Guidelines	14
6.1 Absolute Maximum Ratings	4	9.2 Example Circuit Schematic and Bill of Materials	14
6.2 ESD Ratings	4	10 Device and Documentation Support	16
6.3 Recommended Operating Conditions.....	4	10.1 Receiving Notification of Documentation Updates	16
6.4 Thermal Information	4	10.2 Community Resources.....	16
6.5 Electrical Characteristics.....	5	10.3 Trademarks	16
6.6 Typical Characteristics.....	6	10.4 Electrostatic Discharge Caution.....	16
7 Detailed Description	8	10.5 Glossary	16
7.1 Overview	8	11 Mechanical, Packaging, and Orderable Information	16

4 Revision History

Changes from Original (October 2006) to Revision A

Page

- Added *Application and Implementation* section, *Device Information* table, *Pin Configuration and Functions* section, *ESD Ratings* table, *Thermal Information* table, *Device and Documentation Support* section, and *Mechanical, Packaging, and Orderable Information* section. **1**
- Changed layout of Data Sheet to TI format

5 Pin Configuration and Functions

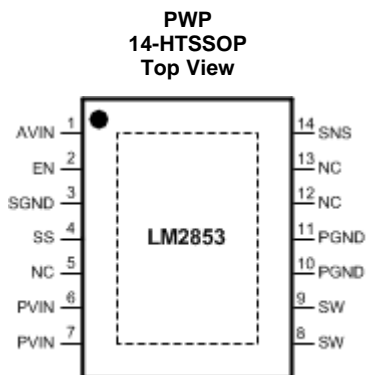

Pin Functions

NO.	NAME	DESCRIPTION
1	AVIN	Input Voltage for Control Circuitry
2	EN	Enable
3	SGND	Low noise ground
4	SS	Soft-Start Pin
5	NC	No Connect. This pin must be tied to ground.
6,7	PVIN	Input Voltage for Power Circuitry
8,9	SW	Switch Pin
10,11	PGND	Power Ground
12,13	NC	No-Connect. These pins must be tied to ground.
14	SNS	Output Voltage Sense Pin
Exposed Pad	EP	The exposed pad is internally connected to GND, but it cannot be used as the primary GND connection. The exposed pad should be soldered to an external GND plane.

6 Specifications

6.1 Absolute Maximum Ratings

over operating free-air temperature range (unless otherwise noted)⁽¹⁾

		MIN	MAX	UNIT
AVIN, PVIN, EN, SNS, SW, SS		-0.3	6	V
Power Dissipation		Internally Limited		V
14-Pin Exposed Pad HTSSOP Package (PWP)	Infrared (15 sec)		220	°C
	Vapor Phase (60 sec)		215	°C
	Soldering (10 sec)		260	°C
Maximum junction temperature			150	°C
Storage temperature, T _{stg}		-65	150	°C

- (1) Stresses beyond those listed under *Absolute Maximum Ratings* may cause permanent damage to the device. These are stress ratings only, which do not imply functional operation of the device at these or any other conditions beyond those indicated under *Recommended Operating Conditions*. Exposure to absolute-maximum-rated conditions for extended periods may affect device reliability.

6.2 ESD Ratings

		VALUE	UNIT
V _(ESD)	Electrostatic discharge Human-body model (HBM), per ANSI/ESDA/JEDEC JS-001 ⁽¹⁾	±2	kV

- (1) JEDEC document JEP155 states that 500-V HBM allows safe manufacturing with a standard ESD control process.

6.3 Recommended Operating Conditions

over operating free-air temperature range (unless otherwise noted)⁽¹⁾

		MIN	MAX	UNIT
PVIN to GND		1.5	5.5	V
AVIN to GND		3	5.5	V
Operation junction temperature, T _J		-40	125	°C

- (1) Absolute maximum ratings indicate limits beyond which damage to the device may occur. Operating Range indicates conditions for which the device is intended to be functional, but does not ensure specific performance limits. For ensured specifications and test conditions, see the Electrical Characteristics.

6.4 Thermal Information

THERMAL METRIC ⁽¹⁾		LM2853	UNIT
		PWP (HTSSOP)	
		14 PINS	
R _{θJA}	Junction-to-ambient thermal resistance	38	°C/W

- (1) For more information about traditional and new thermal metrics, see the [Semiconductor and IC Package Thermal Metrics](#) application report.

6.5 Electrical Characteristics

Specifications with standard typeface are for $T_J = 25^\circ\text{C}$. Minimum and Maximum limits are ensured through test, design or statistical correlation. Typical values represent the most likely parametric norm at $T_J = 25^\circ\text{C}$ and are provided for reference purposes only. Unless otherwise specified $AV_{IN} = PV_{IN} = 5\text{ V}$.

PARAMETER		TEST CONDITIONS		MIN	TYP	MAX	UNIT
SYSTEM PARAMETERS							
V_{OUT}	Voltage tolerance ⁽¹⁾	$V_{OUT} = 0.8\text{ V option}$	$T_J = -40^\circ\text{C to } 125^\circ\text{C}$	0.782	0.8	0.818	V
		$V_{OUT} = 1\text{ V option}$	$T_J = -40^\circ\text{C to } 125^\circ\text{C}$	0.9775	1	1.0225	
		$V_{OUT} = 1.2\text{ V option}$	$T_J = -40^\circ\text{C to } 125^\circ\text{C}$	1.1730	1.2	1.227	
		$V_{OUT} = 1.5\text{ V option}$	$T_J = -40^\circ\text{C to } 125^\circ\text{C}$	1.4663	1.5	1.5337	
		$V_{OUT} = 1.8\text{ V option}$	$T_J = -40^\circ\text{C to } 125^\circ\text{C}$	1.7595	1.8	1.8405	
		$V_{OUT} = 2.5\text{ V option}$	$T_J = -40^\circ\text{C to } 125^\circ\text{C}$	2.4437	2.5	2.5563	
		$V_{OUT} = 3\text{ V option}$	$T_J = -40^\circ\text{C to } 125^\circ\text{C}$	2.9325	3	3.0675	
		$V_{OUT} = 3.3\text{ V option}$	$T_J = -40^\circ\text{C to } 125^\circ\text{C}$	3.2257	3.3	3.3743	
$\Delta V_{OUT}/\Delta A_{VIN}$	Line regulation ⁽¹⁾	$V_{OUT} = 0.8\text{ V, } 1\text{ V, } 1.2\text{ V, } 1.5\text{ V, } 1.8\text{ V or } 2.5\text{ V}$ $3\text{ V} \leq AV_{IN} \leq 5.5\text{ V}$	$T_J = -40^\circ\text{C to } 125^\circ\text{C}$		0.2	1.1	%
		$V_{OUT} = 3\text{ V or } 3.3\text{ V}$ $3.5\text{ V} \leq AV_{IN} \leq 5.5\text{ V}$	$T_J = -40^\circ\text{C to } 125^\circ\text{C}$		0.2	1.1	%
$\Delta V_{OUT}/\Delta I_O$	Load regulation	Normal operation			2		mV/A
V_{ON}	UVLO Threshold (AV_{IN})	Rising	$T_J = -40^\circ\text{C to } 125^\circ\text{C}$		2.47	3	V
		Falling hysteresis	$T_J = -40^\circ\text{C to } 125^\circ\text{C}$	50	155	260	mV
$R_{DS(ON)-P}$	PFET On resistance	$I_{sw} = 3\text{ A}$	$T_J = -40^\circ\text{C to } 125^\circ\text{C}$		40	120	m Ω
$R_{DS(ON)-N}$	NFET On resistance	$I_{sw} = 3\text{ A}$	$T_J = -40^\circ\text{C to } 125^\circ\text{C}$		32	100	m Ω
R_{SS}	Soft-Start resistance				450		k Ω
I_{CL}	Peak current limit threshold			3.6	5		A
I_Q	Operating current	Non-switching	$T_J = -40^\circ\text{C to } 125^\circ\text{C}$		0.85	2	mA
I_{SD}	Shutdown quiescent current	$EN = 0\text{ V}$	$T_J = -40^\circ\text{C to } 125^\circ\text{C}$		12	50	μA
R_{SNS}	Sense pin resistance				432		k Ω
PWM							
f_{osc}	Switching frequency	.	$T_J = -40^\circ\text{C to } 125^\circ\text{C}$	325	550	725	kHz
D_{range}	Duty cycle range		$T_J = -40^\circ\text{C to } 125^\circ\text{C}$	0		100	%
ENABLE CONTROL ⁽²⁾							
V_{IH}	EN Pin minimum high input		$T_J = -40^\circ\text{C to } 125^\circ\text{C}$	75			% of AV_{IN}
V_{IL}	EN Pin maximum low input		$T_J = -40^\circ\text{C to } 125^\circ\text{C}$			25	% of AV_{IN}
I_{EN}	EN Pin pullup current	$EN = 0\text{ V}$			1.5		μA
THERMAL CONTROLS							
T_{SD}	Thermal shutdown threshold				165		$^\circ\text{C}$
T_{SD-HYS}	Hysteresis for thermal shutdown				10		$^\circ\text{C}$

(1) V_{OUT} measured in a non-switching, closed-loop configuration at the SNS pin.

(2) The enable pin is internally pulled up, so the LM2853 is automatically enabled unless an external enable voltage is applied.

6.6 Typical Characteristics

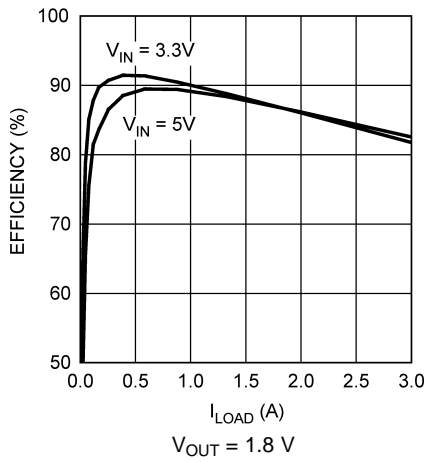

Figure 1. Efficiency vs I_{LOAD}

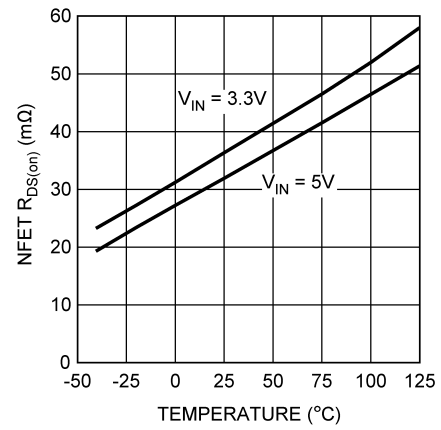

Figure 2. NFET R_{DS(ON)} vs Temperature

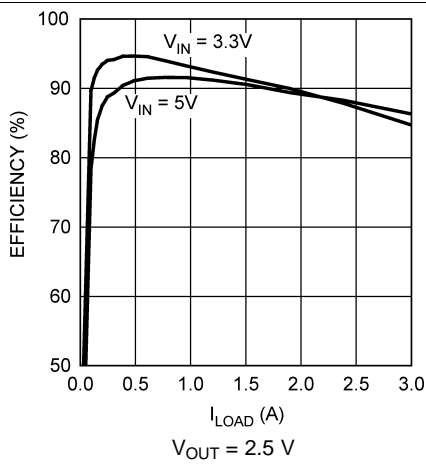

Figure 3. Efficiency vs I_{LOAD}

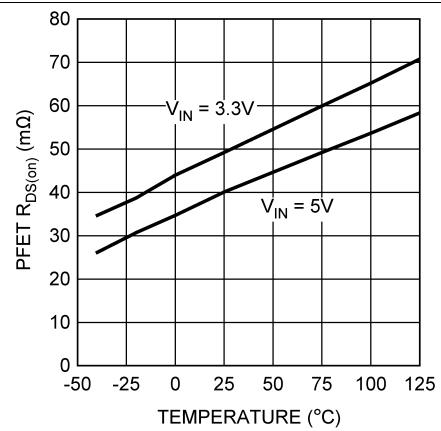
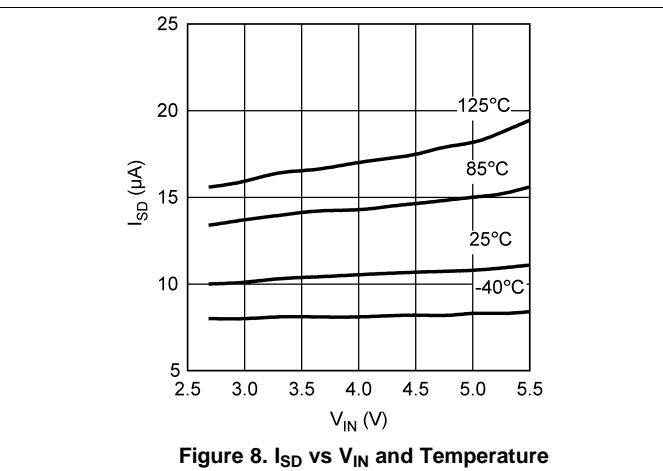
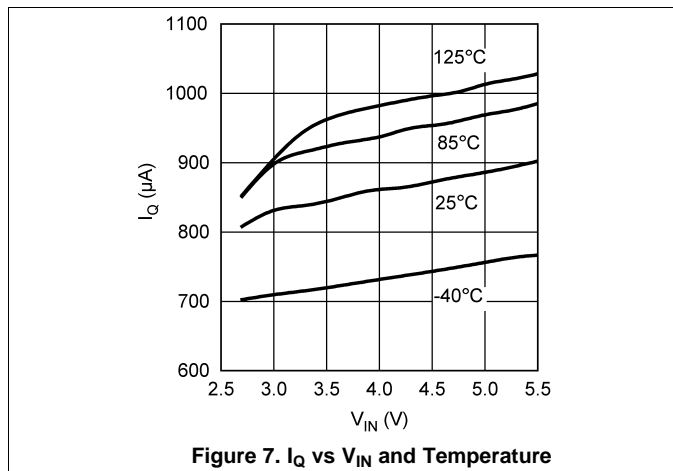
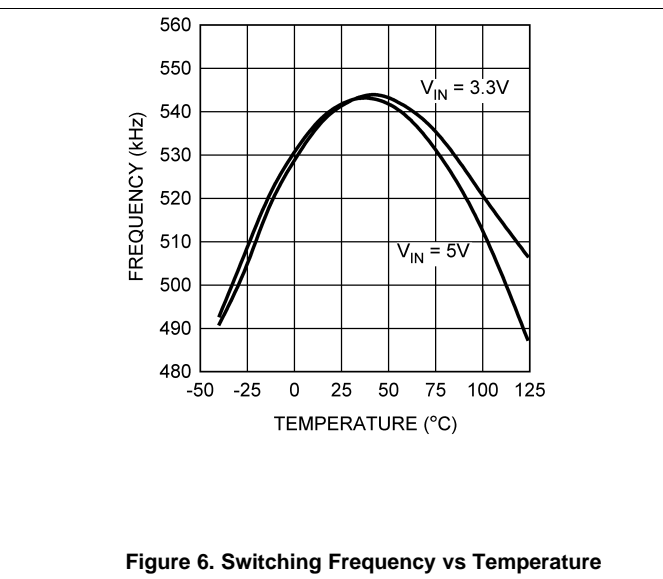
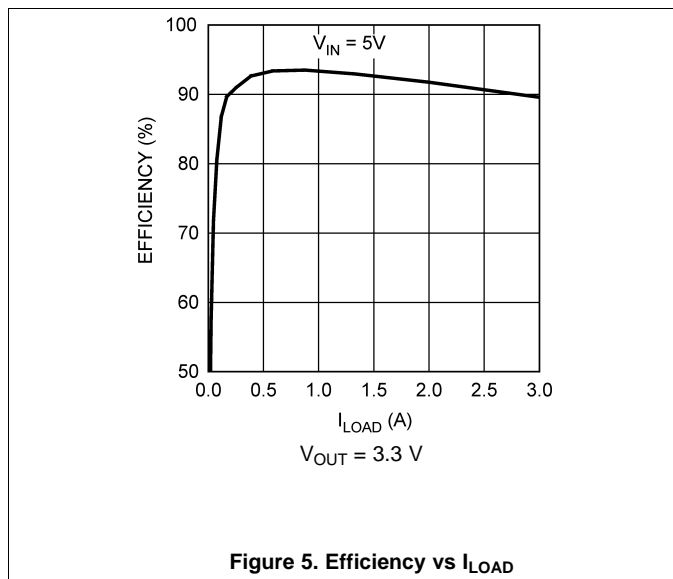

Figure 4. PFET R_{DS(ON)} vs Temperature

Typical Characteristics (continued)



7 Detailed Description

7.1 Overview

The LM2853 is a DC-DC buck regulator belonging to Texas Instrument's synchronous family. Integration of the PWM controller, power switches and compensation network greatly reduces the component count required to implement a switching power supply. A typical application requires only four components: an input capacitor, a soft-start capacitor, an output filter capacitor and an output filter inductor.

7.2 Functional Block Diagram

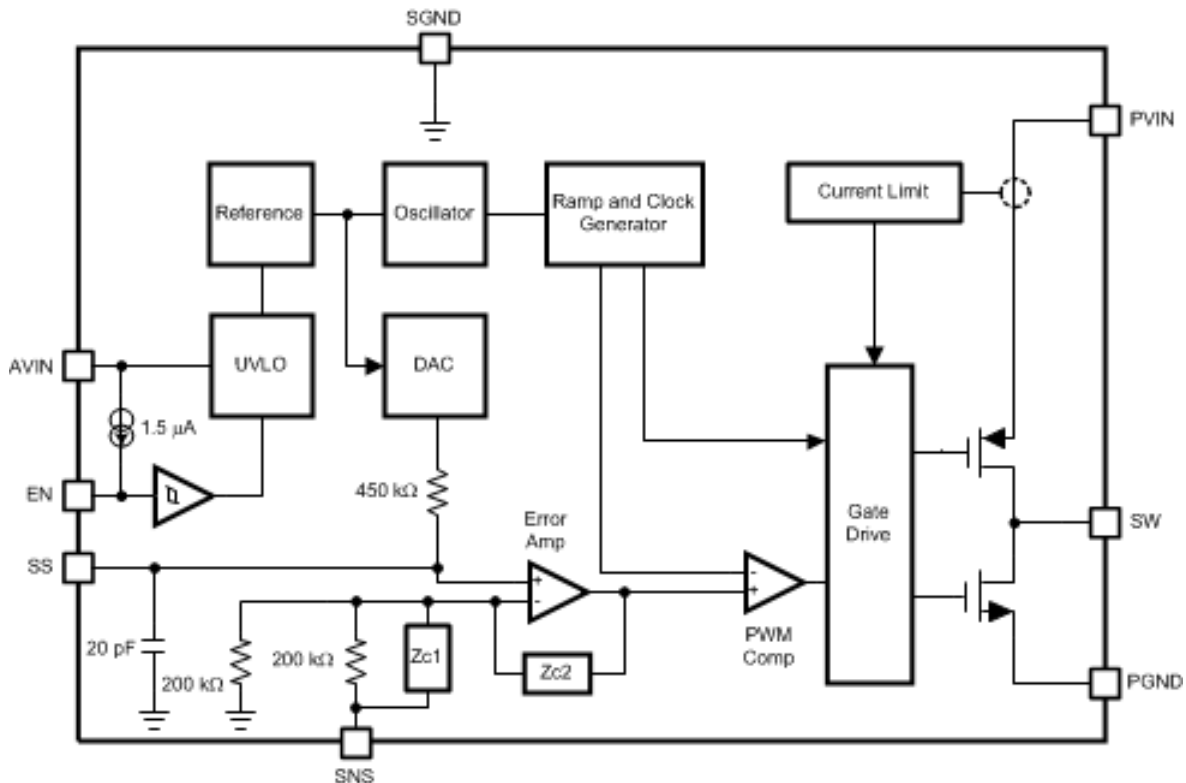

8 Application and Implementation

NOTE

Information in the following applications sections is not part of the TI component specification, and TI does not warrant its accuracy or completeness. TI's customers are responsible for determining suitability of components for their purposes. Customers should validate and test their design implementation to confirm system functionality.

8.1 Application Information

8.1.1 Input Capacitor (C_{IN})

Fast switching of large currents in the buck converter places a heavy demand on the voltage source supplying PVIN. The input capacitor, C_{IN} , supplies extra charge when the switcher needs to draw a burst of current from the supply. The RMS current rating and the voltage rating of the C_{IN} capacitor are therefore important in the selection of C_{IN} . The RMS current specification can be approximated by:

$$I_{RMS} = I_{LOAD} \sqrt{D(1-D)} \quad (1)$$

where D is the duty cycle, V_{OUT}/V_{IN} . C_{IN} also provides filtering of the supply. Trace resistance and inductance degrade the benefits of the input capacitor, so C_{IN} should be placed very close to PVIN in the layout. A 22 μ F or 47 μ F ceramic capacitor is typically sufficient for C_{IN} . In parallel with the large input capacitance a smaller capacitor should be added such as a 1 μ F ceramic for higher frequency filtering. Ceramic capacitors with high quality dielectrics such as X5R or X7R should be used to provide a constant capacitance across temperature and line variations. For improved load regulation and transient performance, the use of a small 1 μ F ceramic capacitor is also recommended as a local bypass for the AVIN pin.

8.1.2 Soft-Start Capacitor (C_{SS})

The DAC that sets the reference voltage of the error amplifier sources a current through a resistor to set the reference voltage. The reference voltage is one half of the output voltage of the switcher due to the 200 k Ω divider connected to the SNS pin. Upon start-up, the output voltage of the switcher tracks the reference voltage with a two to one ratio as the DAC current charges the capacitance connected to the reference voltage node. Internal capacitance of 20 pF is permanently attached to the reference voltage node which is also connected to the soft start pin, SS. Adding a soft-start capacitor externally increases the time it takes for the output voltage to reach its final level. The charging time required for the reference voltage can be estimated using the RC time constant of the DAC resistor and the capacitance connected to the SS pin. Three RC time constant periods are needed for the reference voltage to reach 95% of its final value. The actual start up time will vary with differences in the DAC resistance and higher-order effects.

If little or no soft-start capacitance is connected, then the start up time may be determined by the time required for the current limit current to charge the output filter capacitance. The capacitor charging equation $I = C\Delta V/\Delta t$ can be used to estimate the start-up time in this case. For example, a part with a 3 V output, a 100 μ F output capacitance and a 5A current limit threshold would require a time of 60 μ s:

$$\Delta t = C \frac{\Delta V}{I} = 100 \mu\text{F} \frac{3\text{V}}{5\text{A}} = 60 \mu\text{s} \quad (2)$$

Since it is undesirable for the power supply to start up in current limit, a soft-start capacitor must be chosen to force the LM2853 to start up in a more controlled fashion based on the charging of the soft-start capacitance. In this example, suppose a 3 ms start time is desired. Three time constants are required for charging the soft-start capacitor to 95% of the final reference voltage. So in this case $RC = 1$ ms. The DAC resistor, R, is 450 k Ω so C can be calculated to be 2.2 nF. A 2.2 nF ceramic capacitor can be chosen to yield approximately a 3 ms start-up time.

Application Information (continued)

8.1.3 Soft-Start Capacitor (C_{SS}) and Fault Conditions

Various fault conditions such as short circuit and UVLO of the LM2853 activate internal circuitry designed to control the voltage on the soft-start capacitor. For example, during a short circuit current limit event, the output voltage typically falls to a low voltage. During this time, the soft-start voltage is forced to track the output so that once the short is removed, the LM2853 can restart gracefully from whatever voltage the output reached during the short circuit event. The range of soft-start capacitors is therefore restricted to values 1 nF to 50 nF.

8.1.4 Compensation

The LM2853 provides a highly integrated solution to power supply design. The compensation of the LM2853, which is type-three, is included on-chip. The benefit of integrated compensation is straight-forward, simple power supply design. Since the output filter capacitor and inductor values impact the compensation of the control loop, the range of L_O, C_O and C_{ESR} values is restricted in order to ensure stability.

8.1.5 Output Filter Values

Table 1 details the recommended inductor and capacitor ranges for the LM2853 that are suggested for various typical output voltages. Values slightly different than those recommended may be used, however the phase margin of the power supply may be degraded. For best performance when output voltage ripple is a concern, ESR values near the minimum of the recommended range should be paired with capacitance values near the maximum. If a minimum output voltage ripple solution from a 5 V input voltage is desired, a 6.8 μH inductor can be paired with a 220 μF (50 mΩ) capacitor without degraded phase margin.

Table 1. Recommended L_O and C_O Values

V _{OUT} (V)	V _{IN} (V)	L _O (μH)		C _O (μF)		C _{ESR} (mΩ)	
		MIN	MAX	MIN	MAX	MIN	MAX
0.8	5	4.7	6.8	120	220	70	100
	3.3	4.7	4.7	150	220	50	100
1	5	4.7	6.8	120	220	70	100
	3.3	4.7	4.7	150	220	50	100
1.2	5	4.7	6.8	120	220	70	100
	3.3	4.7	4.7	120	220	60	100
1.5	5	4.7	6.8	120	220	70	100
	3.3	4.7	4.7	120	220	60	100
1.8	5	4.7	6.8	120	220	70	120
	3.3	4.7	4.7	100	220	70	120
2.5	5	4.7	6.8	120	220	70	150
	3.3	4.7	4.7	100	220	80	150
3.0	5	4.7	6.8	120	220	70	150
	3.3	4.7	4.7	100	220	80	150
3.3	5	4.7	6.8	120	220	70	150

8.1.6 Choosing an Inductance Value

The current ripple present in the output filter inductor is determined by the input voltage, output voltage, switching frequency and inductance according to Equation 3.

$$\Delta I_L = \frac{D \times (V_{IN} - V_{OUT})}{f \times L_O} \quad (3)$$

where ΔI_L is the peak to peak current ripple, D is the duty cycle V_{OUT}/V_{IN} , V_{IN} is the input voltage applied to the output stage, V_{OUT} is the output voltage of the switcher, f is the switching frequency and L_O is the inductance of the output filter inductor. Knowing the current ripple is important for inductor selection since the peak current through the inductor is the load current plus one half the ripple current. Care must be taken to ensure the peak inductor current does not reach a level high enough to trip the current limit circuitry of the LM2853. As an example, consider a 5 V to 1.2 V conversion and a 550 kHz switching frequency. According to [Table 1](#), a 4.7 μ H inductor may be used. Calculating the expected peak-to-peak ripple,

$$\Delta I_L = \frac{\frac{1.2V}{5V} \times (5V - 1.2V)}{550 \text{ kHz} \times 4.7 \mu\text{F}} = 353 \text{ mA} \quad (4)$$

The maximum inductor current for a 3A load would therefore be 3A plus 177 mA, 3.177A. As shown in the ripple equation ([Equation 4](#)), the current ripple is inversely proportional to inductance.

8.1.7 Output Filter Inductors

Once the inductance value is chosen, the key parameter for selecting the output filter inductor is its saturation current (I_{SAT}) specification. Typically I_{SAT} is given by the manufacturer as the current at which the inductance of the coil falls to a certain percentage of the nominal inductance. The I_{SAT} of an inductor used in an application should be greater than the maximum expected inductor current to avoid saturation. [Table 2](#) lists inductors that are suitable in LM2853 applications.

Table 2. Recommended Inductors

INDUCTANCE	PART NUMBER	VENDOR
4.7 μ F	DO3308P-472ML	Coilcraft
4.7 μ F	DO3316P-472ML	Coilcraft
4.7 μ F	MSS1260-472ML	Coilcraft
5.2 μ F	MSS1038-522NL	Coilcraft
5.6 μ F	MSS1260-562ML	Coilcraft
6.8 μ F	DO3316P-682ML	Coilcraft
6.8 μ F	MSS1260-682ML	Coilcraft

8.1.8 Output Filter Capacitors

The recommended capacitors that may be used in the output filter with the LM2853 are limited in value and ESR range according to [Table 1](#).

[Table 3](#) shows some examples of capacitors that can typically be used in a LM2853 application.

Table 3. Recommended Capacitors

CAPACITANCE (μ F)	PART NUMBER	CHEMISTRY	VENDOR
100	594D107X_010C2T	Tantalum	Vishay-Sprague
100	593D107X_010D2_E3	Tantalum	Vishay-Sprague
100	TPSC107M006#0075	Tantalum	AVX
100	NOSD107M006#0080	Niobium Oxide	AVX
100	NOSC107M004#0070	Niobium Oxide	AVX
120	594D127X_6R3C2T	Tantalum	Vishay-Sprague
150	594D157X_010C2T	Tantalum	Vishay-Sprague
150	595D157X_010D2T	Tantalum	Vishay-Sprague
150	591D157X_6R3C2_20H	Tantalum	Vishay-Sprague
150	TPSD157M006#0050	Tantalum	AVX
150	TPSC157M004#0070	Tantalum	AVX
150	NOSD157M006#0070	Niobium Oxide	AVX
220	594D227X_6R3D2T	Tantalum	Vishay-Sprague

Table 3. Recommended Capacitors (continued)

CAPACITANCE (μ F)	PART NUMBER	CHEMISTRY	VENDOR
220	591D227X_6R3D2_20H	Tantalum	Vishay-Sprague
220	591D227X_010D2_20H	Tantalum	Vishay-Sprague
220	593D227X_6R3D2_E3	Tantalum	Vishay-Sprague
220	TPSD227M006#0050	Tantalum	AVX
220	NOSD227M0040060	Niobium Oxide	AVX

8.1.9 Split-Rail Operation

The LM2853 can be powered using two separate voltages for AVIN and PVIN. AVIN is the supply for the control logic; PVIN is the supply for the power FETs. The output filter components need to be chosen based on the value of PVIN. For PVIN levels lower than 3.3 V, use output filter component values recommended for 3.3 V. PVIN must always be equal to or less than AVIN.

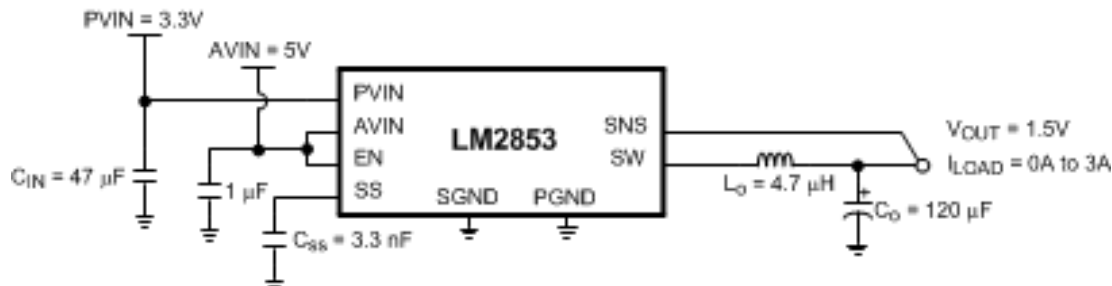

Figure 9. Split-Rail Operation Example Circuit

8.1.10 Switch Node Protection

The LM2853 includes protection circuitry that monitors the voltage on the switch pin. Under certain fault conditions, switching is disabled in order to protect the switching devices. One side effect of the protection circuitry may be observed when power to the LM2853 is applied with no or light load on the output. The output will regulate to the rated voltage, but no switching may be observed. As soon as the output is loaded, the LM2853 will begin normal switching operation.

8.2 Typical Application

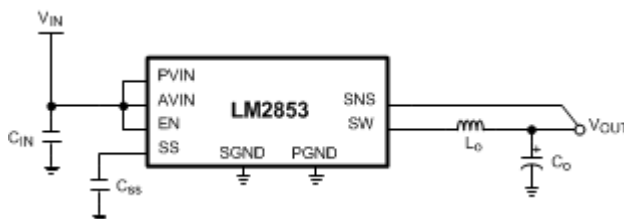

Figure 10. LM2853 Typical Application Circuit

9 Layout

9.1 Layout Guidelines

These are several guidelines to follow while designing the PCB layout for an LM2853 application.

1. The input bulk capacitor, C_{IN} , should be placed very close to the PVIN pin to keep the resistance as low as possible between the capacitor and the pin. High current levels will be present in this connection.
2. All ground connections must be tied together. Use a broad ground plane, for example a completely filled back plane, to establish the lowest resistance possible between all ground connections.
3. The sense pin connection should be made as close to the load as possible so that the voltage at the load is the expected regulated value. The sense line should not run too close to nodes with high dV/dt or dI/dt (such as the switch node) to minimize interference.
4. The switch node connections should be low resistance to reduce power losses. Low resistance means the trace between the switch pin and the inductor should be wide. However, the area of the switch node should not be too large since EMI increases with greater area. So connect the inductor to the switch pin with a short, but wide trace. Other high current connections in the application such as PVIN and V_{OUT} assume the same trade off between low resistance and EMI.
5. Allow area under the chip to solder the entire exposed die attach pad to ground for improved thermal performance. Lab measurements also show improved regulation performance when the exposed pad is well grounded.

9.2 Example Circuit Schematic and Bill of Materials

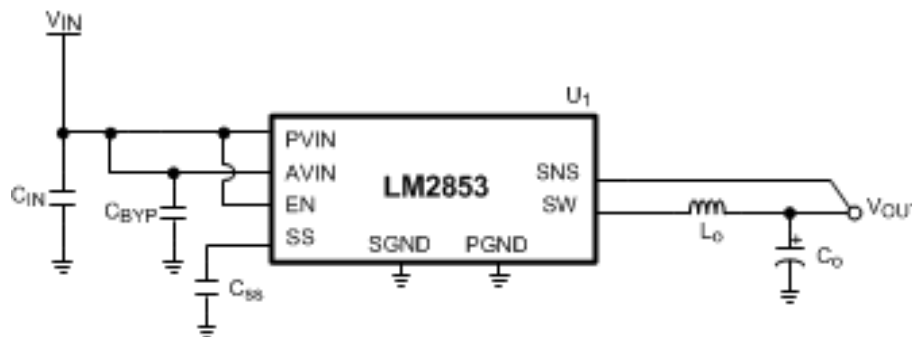

Figure 11. LM2853 Example Circuit Schematic

Table 4. Bill of Materials for 5 V to 3.3 V Conversion

ID	PART NUMBER	TYPE	SIZE	PARAMETERS	QTY	VENDOR
U ₁	LM2853MH-3.3	3A Buck	HTSSOP-14	3.3 V	1	TI
C _{IN}	GRM31CR60J476ME19	Capacitor	1206	47 μ F	1	Murata
C _{BYP}	GRM21BR71C105KA01	Capacitor	0805	1 μ F	1	Murata
C _{SS}	VJ0805Y222KXXA	Capacitor	0603	2.2 nF	1	Vishay-Vitramon
L _O	DO3316P-682	Inductor	DO3316P	6.8 μ H	1	Coilcraft
C _O	594D127X06R3C2T	Capacitor	C Case	120 μ F (85 m Ω)	1	Vishay-Sprague

Table 5. Bill of Materials for 3.3 V to 1.2 V Conversion

ID	PART NUMBER	TYPE	SIZE	PARAMETERS	QTY	VENDOR
U ₁	LM2853MH-1.2	3A Buck	HTSSOP-14	1.2 V	1	TI
C _{IN}	GRM31CR60J476ME19	Capacitor	1206	47 μ F	1	Murata
C _{BYP}	GRM21BR71C105KA01	Capacitor	0805	1 μ F	1	Murata
C _{SS}	VJ0805Y222KXXA	Capacitor	0603	2.2 nF	1	Vishay-Vitramon
L _O	DO3316P-472	Inductor	DO3316P	4.7 μ H	1	Coilcraft

Table 5. Bill of Materials for 3.3 V to 1.2 V Conversion (continued)

ID	PART NUMBER	TYPE	SIZE	PARAMETERS	QTY	VENDOR
C _O	NOSD157M006R0070	Capacitor	D Case	150 μ F (70 m Ω)	1	AVX

10 Device and Documentation Support

10.1 Receiving Notification of Documentation Updates

To receive notification of documentation updates, navigate to the device product folder on ti.com. In the upper right corner, click on *Alert me* to register and receive a weekly digest of any product information that has changed. For change details, review the revision history included in any revised document.

10.2 Community Resources

The following links connect to TI community resources. Linked contents are provided "AS IS" by the respective contributors. They do not constitute TI specifications and do not necessarily reflect TI's views; see TI's [Terms of Use](#).

TI E2E™ Online Community *TI's Engineer-to-Engineer (E2E) Community*. Created to foster collaboration among engineers. At e2e.ti.com, you can ask questions, share knowledge, explore ideas and help solve problems with fellow engineers.

Design Support *TI's Design Support* Quickly find helpful E2E forums along with design support tools and contact information for technical support.

10.3 Trademarks

E2E is a trademark of Texas Instruments.
All other trademarks are the property of their respective owners.

10.4 Electrostatic Discharge Caution



This integrated circuit can be damaged by ESD. Texas Instruments recommends that all integrated circuits be handled with appropriate precautions. Failure to observe proper handling and installation procedures can cause damage.

ESD damage can range from subtle performance degradation to complete device failure. Precision integrated circuits may be more susceptible to damage because very small parametric changes could cause the device not to meet its published specifications.

10.5 Glossary

[SLYZ022](#) — *TI Glossary*.

This glossary lists and explains terms, acronyms, and definitions.

11 Mechanical, Packaging, and Orderable Information

The following pages include mechanical, packaging, and orderable information. This information is the most current data available for the designated devices. This data is subject to change without notice and revision of this document. For browser-based versions of this data sheet, refer to the left-hand navigation.

PACKAGING INFORMATION

Orderable Device	Status (1)	Package Type	Package Drawing	Pins	Package Qty	Eco Plan (2)	Lead/Ball Finish (6)	MSL Peak Temp (3)	Op Temp (°C)	Device Marking (4/5)	Samples
LM2853MH-1.0/NOPB	ACTIVE	HTSSOP	PWP	14	94	Green (RoHS & no Sb/Br)	CU SN	Level-1-260C-UNLIM	-40 to 125	LM2853 -1.0	Samples
LM2853MH-1.2/NOPB	ACTIVE	HTSSOP	PWP	14	94	Green (RoHS & no Sb/Br)	CU SN	Level-1-260C-UNLIM	-40 to 125	LM2853 -1.2	Samples
LM2853MH-1.5/NOPB	ACTIVE	HTSSOP	PWP	14	94	Green (RoHS & no Sb/Br)	CU SN	Level-1-260C-UNLIM	-40 to 125	LM2853 -1.5	Samples
LM2853MH-1.8/NOPB	ACTIVE	HTSSOP	PWP	14	94	Green (RoHS & no Sb/Br)	CU SN	Level-1-260C-UNLIM	-40 to 125	LM2853 -1.8	Samples
LM2853MH-2.5/NOPB	ACTIVE	HTSSOP	PWP	14	94	Green (RoHS & no Sb/Br)	CU SN	Level-1-260C-UNLIM	-40 to 125	LM2853 -2.5	Samples
LM2853MH-3.0/NOPB	ACTIVE	HTSSOP	PWP	14	94	Green (RoHS & no Sb/Br)	CU SN	Level-1-260C-UNLIM	-40 to 125	LM2853 -3.0	Samples
LM2853MH-3.3/NOPB	ACTIVE	HTSSOP	PWP	14	94	Green (RoHS & no Sb/Br)	CU SN	Level-1-260C-UNLIM	-40 to 125	LM2853 -3.3	Samples
LM2853MHX-1.0/NOPB	ACTIVE	HTSSOP	PWP	14	2500	Green (RoHS & no Sb/Br)	CU SN	Level-1-260C-UNLIM	-40 to 125	LM2853 -1.0	Samples
LM2853MHX-1.2/NOPB	ACTIVE	HTSSOP	PWP	14	2500	Green (RoHS & no Sb/Br)	CU SN	Level-1-260C-UNLIM	-40 to 125	LM2853 -1.2	Samples
LM2853MHX-1.5/NOPB	ACTIVE	HTSSOP	PWP	14	2500	Green (RoHS & no Sb/Br)	CU SN	Level-1-260C-UNLIM	-40 to 125	LM2853 -1.5	Samples
LM2853MHX-1.8/NOPB	ACTIVE	HTSSOP	PWP	14	2500	Green (RoHS & no Sb/Br)	CU SN	Level-1-260C-UNLIM	-40 to 125	LM2853 -1.8	Samples
LM2853MHX-2.5/NOPB	ACTIVE	HTSSOP	PWP	14	2500	Green (RoHS & no Sb/Br)	CU SN	Level-1-260C-UNLIM	-40 to 125	LM2853 -2.5	Samples
LM2853MHX-3.3/NOPB	ACTIVE	HTSSOP	PWP	14	2500	Green (RoHS & no Sb/Br)	CU SN	Level-1-260C-UNLIM	-40 to 125	LM2853 -3.3	Samples

(1) The marketing status values are defined as follows:

ACTIVE: Product device recommended for new designs.

LIFEBUY: TI has announced that the device will be discontinued, and a lifetime-buy period is in effect.

NRND: Not recommended for new designs. Device is in production to support existing customers, but TI does not recommend using this part in a new design.

PREVIEW: Device has been announced but is not in production. Samples may or may not be available.

OBSOLETE: TI has discontinued the production of the device.

(2) **RoHS:** TI defines "RoHS" to mean semiconductor products that are compliant with the current EU RoHS requirements for all 10 RoHS substances, including the requirement that RoHS substance do not exceed 0.1% by weight in homogeneous materials. Where designed to be soldered at high temperatures, "RoHS" products are suitable for use in specified lead-free processes. TI may reference these types of products as "Pb-Free".

RoHS Exempt: TI defines "RoHS Exempt" to mean products that contain lead but are compliant with EU RoHS pursuant to a specific EU RoHS exemption.

Green: TI defines "Green" to mean the content of Chlorine (Cl) and Bromine (Br) based flame retardants meet JS709B low halogen requirements of ≤ 1000 ppm threshold. Antimony trioxide based flame retardants must also meet the ≤ 1000 ppm threshold requirement.

(3) MSL, Peak Temp. - The Moisture Sensitivity Level rating according to the JEDEC industry standard classifications, and peak solder temperature.

(4) There may be additional marking, which relates to the logo, the lot trace code information, or the environmental category on the device.

(5) Multiple Device Markings will be inside parentheses. Only one Device Marking contained in parentheses and separated by a "~" will appear on a device. If a line is indented then it is a continuation of the previous line and the two combined represent the entire Device Marking for that device.

(6) Lead/Ball Finish - Orderable Devices may have multiple material finish options. Finish options are separated by a vertical ruled line. Lead/Ball Finish values may wrap to two lines if the finish value exceeds the maximum column width.

Important Information and Disclaimer: The information provided on this page represents TI's knowledge and belief as of the date that it is provided. TI bases its knowledge and belief on information provided by third parties, and makes no representation or warranty as to the accuracy of such information. Efforts are underway to better integrate information from third parties. TI has taken and continues to take reasonable steps to provide representative and accurate information but may not have conducted destructive testing or chemical analysis on incoming materials and chemicals. TI and TI suppliers consider certain information to be proprietary, and thus CAS numbers and other limited information may not be available for release.

In no event shall TI's liability arising out of such information exceed the total purchase price of the TI part(s) at issue in this document sold by TI to Customer on an annual basis.

TAPE AND REEL INFORMATION

QUADRANT ASSIGNMENTS FOR PIN 1 ORIENTATION IN TAPE

*All dimensions are nominal

Device	Package Type	Package Drawing	Pins	SPQ	Reel Diameter (mm)	Reel Width W1 (mm)	A0 (mm)	B0 (mm)	K0 (mm)	P1 (mm)	W (mm)	Pin1 Quadrant
LM2853MHX-1.0/NOPB	HTSSOP	PWP	14	2500	330.0	12.4	6.95	5.6	1.6	8.0	12.0	Q1
LM2853MHX-1.2/NOPB	HTSSOP	PWP	14	2500	330.0	12.4	6.95	5.6	1.6	8.0	12.0	Q1
LM2853MHX-1.5/NOPB	HTSSOP	PWP	14	2500	330.0	12.4	6.95	5.6	1.6	8.0	12.0	Q1
LM2853MHX-1.8/NOPB	HTSSOP	PWP	14	2500	330.0	12.4	6.95	5.6	1.6	8.0	12.0	Q1
LM2853MHX-2.5/NOPB	HTSSOP	PWP	14	2500	330.0	12.4	6.95	5.6	1.6	8.0	12.0	Q1
LM2853MHX-3.3/NOPB	HTSSOP	PWP	14	2500	330.0	12.4	6.95	5.6	1.6	8.0	12.0	Q1

TAPE AND REEL BOX DIMENSIONS

*All dimensions are nominal

Device	Package Type	Package Drawing	Pins	SPQ	Length (mm)	Width (mm)	Height (mm)
LM2853MHX-1.0/NOPB	HTSSOP	PWP	14	2500	367.0	367.0	35.0
LM2853MHX-1.2/NOPB	HTSSOP	PWP	14	2500	367.0	367.0	35.0
LM2853MHX-1.5/NOPB	HTSSOP	PWP	14	2500	367.0	367.0	35.0
LM2853MHX-1.8/NOPB	HTSSOP	PWP	14	2500	367.0	367.0	35.0
LM2853MHX-2.5/NOPB	HTSSOP	PWP	14	2500	367.0	367.0	35.0
LM2853MHX-3.3/NOPB	HTSSOP	PWP	14	2500	367.0	367.0	35.0

IMPORTANT NOTICE AND DISCLAIMER

TI PROVIDES TECHNICAL AND RELIABILITY DATA (INCLUDING DATASHEETS), DESIGN RESOURCES (INCLUDING REFERENCE DESIGNS), APPLICATION OR OTHER DESIGN ADVICE, WEB TOOLS, SAFETY INFORMATION, AND OTHER RESOURCES "AS IS" AND WITH ALL FAULTS, AND DISCLAIMS ALL WARRANTIES, EXPRESS AND IMPLIED, INCLUDING WITHOUT LIMITATION ANY IMPLIED WARRANTIES OF MERCHANTABILITY, FITNESS FOR A PARTICULAR PURPOSE OR NON-INFRINGEMENT OF THIRD PARTY INTELLECTUAL PROPERTY RIGHTS.



These resources are intended for skilled developers designing with TI products. You are solely responsible for (1) selecting the appropriate TI products for your application, (2) designing, validating and testing your application, and (3) ensuring your application meets applicable standards, and any other safety, security, or other requirements. These resources are subject to change without notice. TI grants you permission to use these resources only for development of an application that uses the TI products described in the resource. Other reproduction and display of these resources is prohibited. No license is granted to any other TI intellectual property right or to any third party intellectual property right. TI disclaims responsibility for, and you will fully indemnify TI and its representatives against, any claims, damages, costs, losses, and liabilities arising out of your use of these resources.

TI's products are provided subject to TI's Terms of Sale (www.ti.com/legal/termsofsale.html) or other applicable terms available either on ti.com or provided in conjunction with such TI products. TI's provision of these resources does not expand or otherwise alter TI's applicable warranties or warranty disclaimers for TI products.

Mailing Address: Texas Instruments, Post Office Box 655303, Dallas, Texas 75265
Copyright © 2019, Texas Instruments Incorporated

Looking for pricing, stock, or lifecycle information?

Click below to explore more details on WIN SOURCE:

-  [View LM2853MH-1.2/NOPB on WIN SOURCE](#)
-  [Texas Instruments](#) Information

Optimize Your Supply Chain with WIN SOURCE Solutions

-  Global Sourcing Solution
-  Obsolete Management
-  Cost Control Management
-  Shortage Management
-  Alternative Solution
-  Excess Inventory Management