



THE DATASHEET OF LM2930SX-5.0



LM2930 3-Terminal Positive Regulator

Check for Samples: [LM2930](#)

FEATURES

- Input-Output Differential Less Than 0.6V
- Output Current in Excess of 150 mA
- Reverse Battery Protection
- 40V Load Dump Protection
- Internal Short Circuit Current Limit
- Internal Thermal Overload Protection
- Mirror-Image Insertion Protection
- P⁺ Product Enhancement Tested

VOLTAGE RANGE

- LM2930T-5.0: 5V
- LM2930T-8.0: 8V
- LM2930S-5.0: 5V
- LM2930S-8.0: 8V

DESCRIPTION

The LM2930 3-terminal positive regulator features an ability to source 150 mA of output current with an input-output differential of 0.6V or less. Efficient use of low input voltages obtained, for example, from an automotive battery during cold crank conditions, allows 5V circuitry to be properly powered with supply voltages as low as 5.6V. Familiar regulator features such as current limit and thermal overload protection are also provided.

Designed originally for automotive applications, the LM2930 and all regulated circuitry are protected from reverse battery installations or 2 battery jumps. During line transients, such as a load dump (40V) when the input voltage to the regulator can momentarily exceed the specified maximum operating voltage, the regulator will automatically shut down to protect both internal circuits and the load. The LM2930 cannot be harmed by temporary mirror-image insertion.

Fixed outputs of 5V and 8V are available in the plastic TO-220 and SFM power packages.

Connection Diagrams

TO-220 Plastic Package

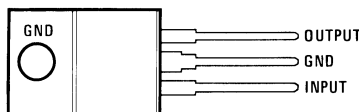

Figure 1. Front View
See Package Number NDE

SFM Plastic Surface-Mount Package

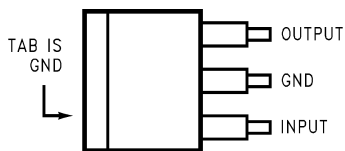

Figure 2. Top View
See Package Number KTT

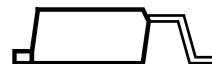

Figure 3. Side View
See Package Number KTT



Please be aware that an important notice concerning availability, standard warranty, and use in critical applications of Texas Instruments semiconductor products and disclaimers thereto appears at the end of this data sheet.

All trademarks are the property of their respective owners.



These devices have limited built-in ESD protection. The leads should be shorted together or the device placed in conductive foam during storage or handling to prevent electrostatic damage to the MOS gates.

Absolute Maximum Ratings⁽¹⁾⁽²⁾

Input Voltage	Operating Range	26V
	Overvoltage Protection	40V
	Reverse Voltage (100 ms)	-12V
	Reverse Voltage (DC)	-6V
Internal Power Dissipation ⁽³⁾		Internally Limited
Operating Temperature Range		-40°C to +85°C
Maximum Junction Temperature		125°C
Storage Temperature Range		-65°C to +150°C
Lead Temp. (Soldering, 10 seconds)		230°C

- (1) Absolute Maximum Ratings indicate limits beyond which damage to the device may occur. Operating ratings indicate conditions for which the device is functional, but do not ensure specific performance limits. Electrical Characteristics state DC and AC electrical specifications under particular test conditions which ensure specific performance limits. This assumes that the device is within the Operating Ratings. Specifications are not ensured for parameters where no limit is given, however, the typical value is a good indication of device performance.
- (2) If Military/Aerospace specified devices are required, please contact the Texas Instruments Sales Office/Distributors for availability and specifications.
- (3) Thermal resistance without a heat sink for junction to case temperature is 3°C/W and for case to ambient temperature is 50°C/W for the TO-220, 73°C/W for the SFM. If the SFM package is used, the thermal resistance can be reduced by increasing the P.C. board copper area thermally connected to the package. Using 0.5 square inches of copper area, θ_{JA} is 50°C/W; with 1 square inch of copper area, θ_{JA} is 37°C/W; and with 1.6 or more square inches of copper area, θ_{JA} is 32°C/W.

Electrical Characteristics⁽¹⁾

LM2930-5.0 $V_{IN}=14V$, $I_O=150\text{ mA}$, $T_J=25^\circ\text{C}$ ⁽²⁾, $C_2=10\text{ }\mu\text{F}$, unless otherwise specified

Parameter	Conditions	Typ	Tested Limit ⁽³⁾	Design Limit ⁽⁴⁾	Unit
Output Voltage		5	5.3		V_{MAX}
			4.7		V_{MIN}
Line Regulation	$6V \leq V_{IN} \leq 26V$, $5\text{ mA} \leq I_O \leq 150\text{ mA}$ $-40^\circ\text{C} \leq T_J \leq 125^\circ\text{C}$			5.5	V_{MAX}
				4.5	V_{MIN}
Load Regulation	$9V \leq V_{IN} \leq 16V$, $I_O=5\text{ mA}$	7	25		mV_{MAX}
	$6V \leq V_{IN} \leq 26V$, $I_O=5\text{ mA}$	30	80		mV_{MAX}
Load Regulation	$5\text{ mA} \leq I_O \leq 150\text{ mA}$	14	50		mV_{MAX}
Output Impedance	100 mA_{DC} & 10 mA_{rms} , 100 Hz–10 kHz	200			$m\Omega$
Quiescent Current	$I_O=10\text{ mA}$	4	7		mA_{MAX}
	$I_O=150\text{ mA}$	18	40		mA_{MAX}
Output Noise Voltage	10 Hz–100 kHz	140			μV_{rms}
Long Term Stability		20			$mV/1000\text{ hr}$
Ripple Rejection	$f_O=120\text{ Hz}$	56			dB
Current Limit		400	700		mA_{MAX}
			150		mA_{MIN}
Dropout Voltage	$I_O=150\text{ mA}$	0.32	0.6		V_{MAX}
Output Voltage Under	$-12V \leq V_{IN} \leq 40V$, $R_L=100\Omega$		5.5		V_{MAX}
Transient Conditions			-0.3		V_{MIN}

- (1) All characteristics are measured with a capacitor across the input of 0.1 μF and a capacitor across the output of 10 μF . All characteristics except noise voltage and ripple rejection ratio are measured using pulse techniques ($t_w \leq 10\text{ ms}$, duty cycles $\leq 5\%$). Output voltage changes due to changes in internal temperature must be taken into account separately.
- (2) To ensure constant junction temperature, low duty cycle pulse testing is used.
- (3) Ensured and 100% production tested.
- (4) Ensured (but not 100% production tested) over the operating temperature and input current ranges. These limits are not used to calculate outgoing quality levels.

Electrical Characteristics⁽¹⁾

 LM2930-8.0 ($V_{IN}=14V$, $I_O=150\text{ mA}$, $T_J=25^\circ\text{C}$ ⁽²⁾, $C_2=10\text{ }\mu\text{F}$, unless otherwise specified)

Parameter	Conditions	Typ	Tested Limit ⁽³⁾	Design Limit ⁽⁴⁾	Unit	
Output Voltage		8	8.5		V_{MAX}	
			7.5		V_{MIN}	
	$9.4V \leq V_{IN} \leq 26V$, $5\text{ mA} \leq I_O \leq 150\text{ mA}$, $-40^\circ\text{C} \leq T_J \leq 125^\circ\text{C}$				8.8	V_{MAX}
					7.2	V_{MIN}
Line Regulation	$9.4V \leq V_{IN} \leq 16V$, $I_O=5\text{ mA}$	12	50		mV_{MAX}	
	$9.4V \leq V_{IN} \leq 26V$, $I_O=5\text{ mA}$	50	100		mV_{MAX}	
Load Regulation	$5\text{ mA} \leq I_O \leq 150\text{ mA}$	25	50		mV_{MAX}	
Output Impedance	100 mA_{DC} & 10 mA_{rms} , 100 Hz–10 kHz	300			$\text{m}\Omega$	
Quiescent Current	$I_O=10\text{ mA}$	4	7		mA_{MAX}	
	$I_O=150\text{ mA}$	18	40		mA_{MAX}	
Output Noise Voltage	10 Hz–100 kHz	170			μV_{rms}	
Long Term Stability		30			$\text{mV}/1000\text{ hr}$	
Ripple Rejection	$f_O=120\text{ Hz}$	52			dB	
Current Limit		400	700		mA_{MAX}	
			150		mA_{MIN}	
Dropout Voltage	$I_O=150\text{ mA}$	0.32	0.6		V_{MAX}	
Output Voltage Under	$-12V \leq V_{IN} \leq 40V$, $R_L=100\Omega$		8.8		V_{MAX}	
Transient Conditions			-0.3		V_{MIN}	

- (1) All characteristics are measured with a capacitor across the input of $0.1\text{ }\mu\text{F}$ and a capacitor across the output of $10\text{ }\mu\text{F}$. All characteristics except noise voltage and ripple rejection ratio are measured using pulse techniques ($t_W \leq 10\text{ ms}$, duty cycle $\leq 5\%$). Output voltage changes due to changes in internal temperature must be taken into account separately.
- (2) To ensure constant junction temperature, low duty cycle pulse testing is used.
- (3) Ensured and 100% production tested.
- (4) Ensured (but not 100% production tested) over the operating temperature and input current ranges. These limits are not used to calculate outgoing quality levels.

Typical Application

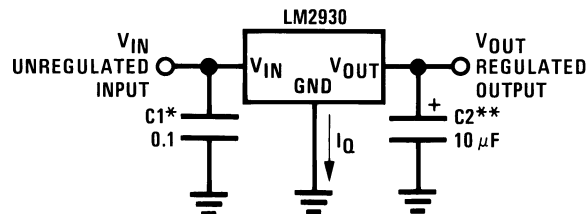

*Required if regulator is located far from power supply filter.

** C_{OUT} must be at least $10\text{ }\mu\text{F}$ to maintain stability. May be increased without bound to maintain regulation during transients. Locate as close as possible to the regulator. This capacitor must be rated over the same operating temperature range as the regulator. The equivalent series resistance (ESR) of this capacitor should be less than 1Ω over the expected operating temperature range.

Typical Performance Characteristics

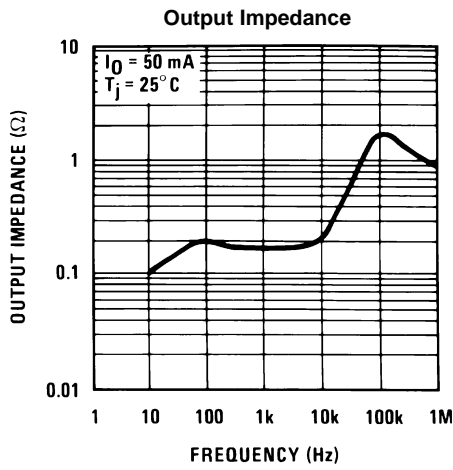

Figure 4.

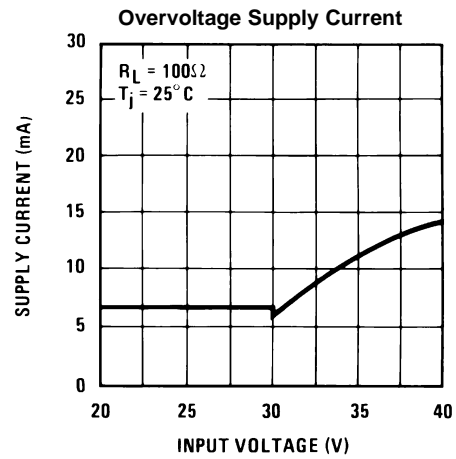

Figure 5.

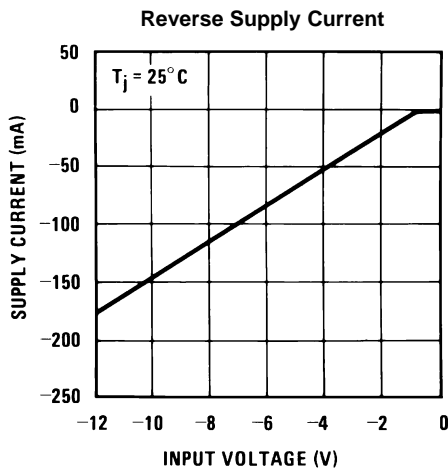

Figure 6.

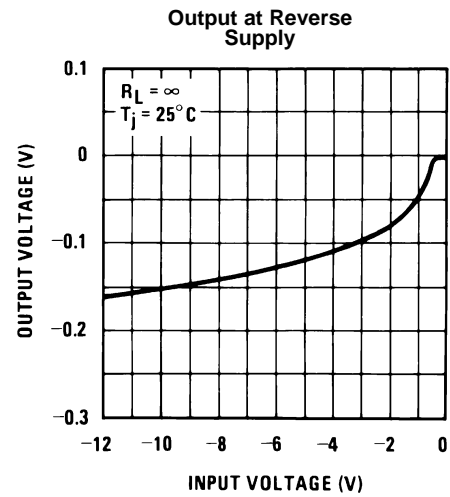

Figure 7.

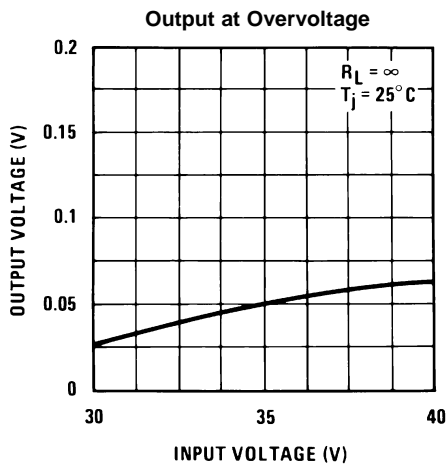

Figure 8.

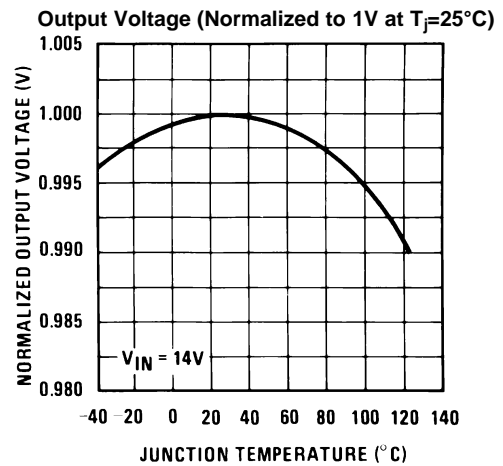

Figure 9.

Typical Performance Characteristics (continued)

Dropout Voltage

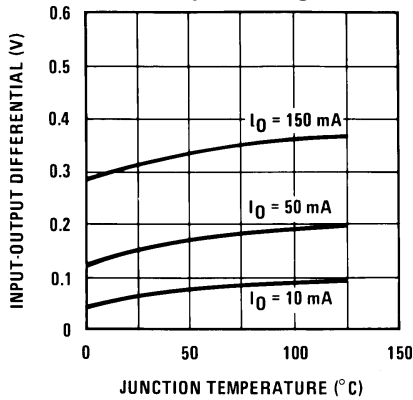

Figure 10.

Dropout Voltage

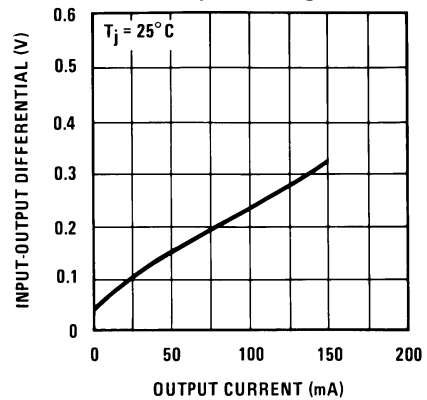

Figure 11.

Low Voltage Behavior

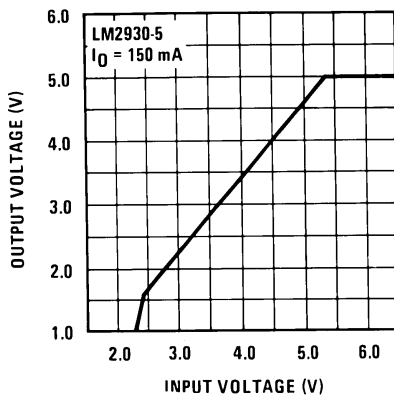

Figure 12.

High Voltage Behavior

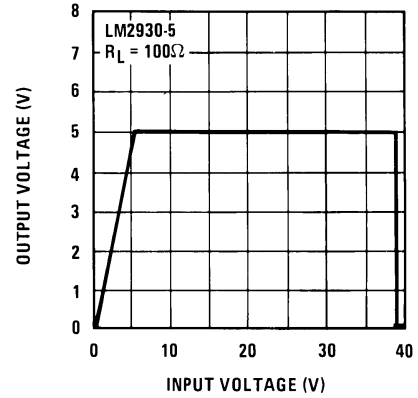

Figure 13.

Line Transient Response

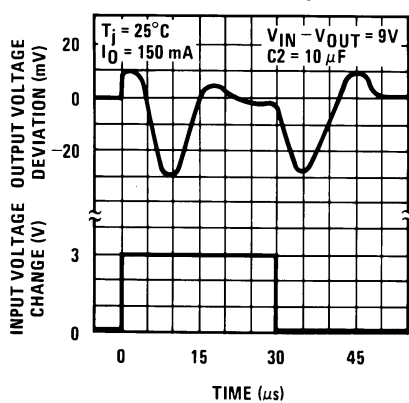

Figure 14.

Load Transient Response

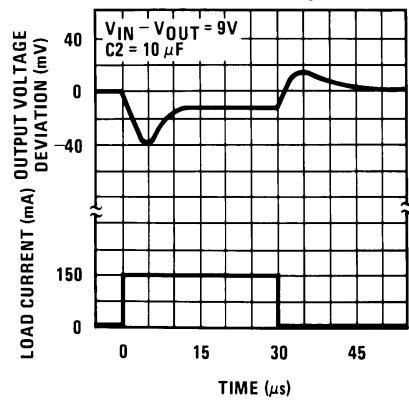

Figure 15.

Typical Performance Characteristics (continued)

Peak Output Current

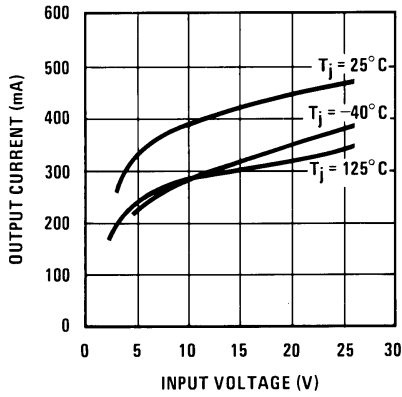

Figure 16.

Quiescent Current

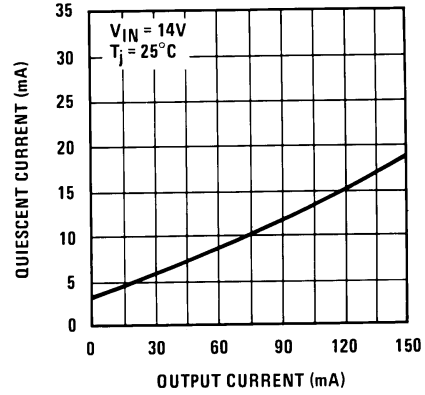

Figure 17.

Quiescent Current

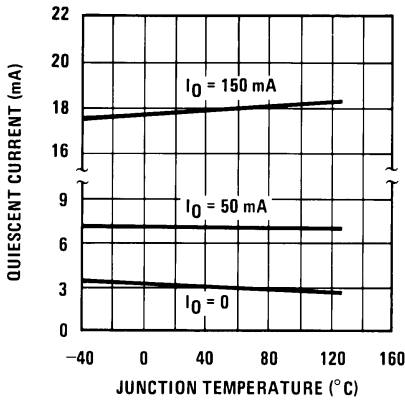

Figure 18.

Quiescent Current

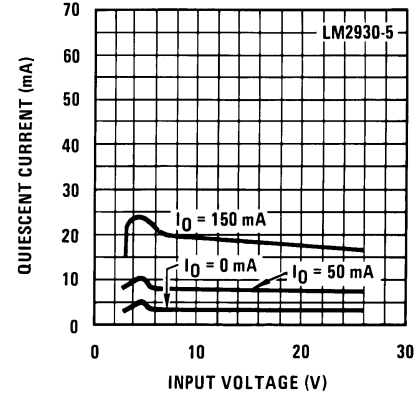

Figure 19.

Ripple Rejection

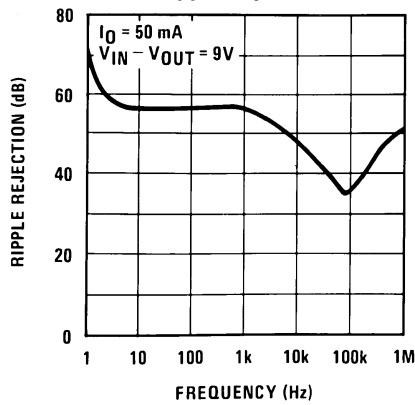

Figure 20.

Ripple Rejection

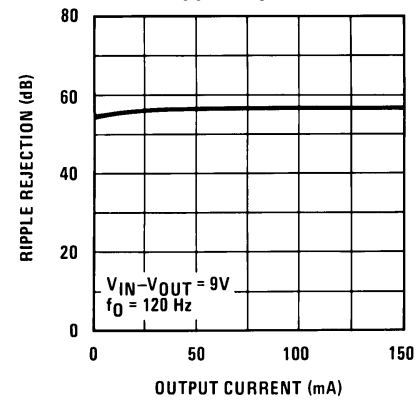

Figure 21.

Definition of Terms

Dropout Voltage: The input-output voltage differential at which the circuit ceases to regulate against further reduction in input voltage. Measured when the output voltage has dropped 100 mV from the nominal value obtained at 14V input, dropout voltage is dependent upon load current and junction temperature.

Input Voltage: The DC voltage applied to the input terminals with respect to ground.

Input-Output Differential: The voltage difference between the unregulated input voltage and the regulated output voltage for which the regulator will operate.

Line Regulation: The change in output voltage for a change in the input voltage. The measurement is made under conditions of low dissipation or by using pulse techniques such that the average chip temperature is not significantly affected.

Load Regulation: The change in output voltage for a change in load current at constant chip temperature.

Long Term Stability: Output voltage stability under accelerated life-test conditions after 1000 hours with maximum rated voltage and junction temperature.

Output Noise Voltage: The rms AC voltage at the output, with constant load and no input ripple, measured over a specified frequency range.

Quiescent Current: That part of the positive input current that does not contribute to the positive load current. The regulator ground lead current.

Ripple Rejection: The ratio of the peak-to-peak input ripple voltage to the peak-to-peak output ripple voltage.

Temperature Stability of V_O : The percentage change in output voltage for a thermal variation from room temperature to either temperature extreme.

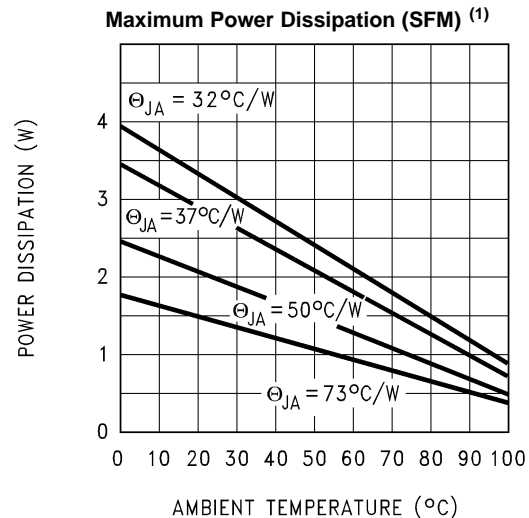
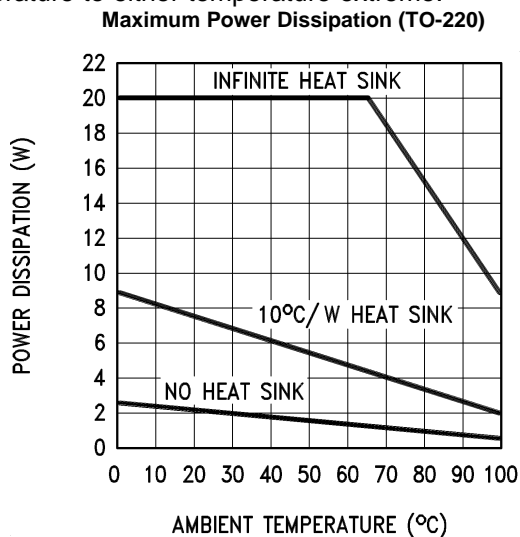

(1) Thermal resistance without a heat sink for junction to case temperature is 3°C/W and for case to ambient temperature is 50°C/W for the TO-220, 73°C/W for the SFM. If the SFM package is used, the thermal resistance can be reduced by increasing the P.C. board copper area thermally connected to the package. Using 0.5 square inches of copper area, θ_{JA} is 50°C/W; with 1 square inch of copper area, θ_{JA} is 37°C/W; and with 1.6 or more square inches of copper area, θ_{JA} is 32°C/W.

Schematic Diagram

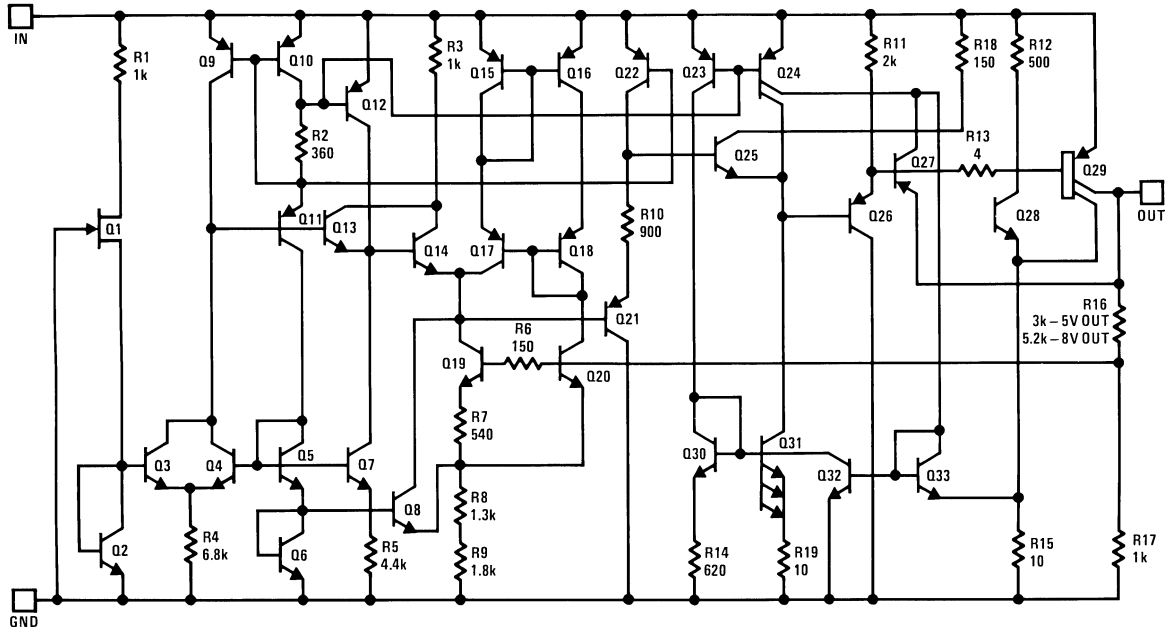

REVISION HISTORY

Changes from Revision C (April 2013) to Revision D	Page
<hr/> <ul style="list-style-type: none">• Changed layout of National Data Sheet to TI format	<hr/> 8

PACKAGING INFORMATION

Orderable Device	Status (1)	Package Type	Package Drawing	Pins	Package Qty	Eco Plan (2)	Lead/Ball Finish (6)	MSL Peak Temp (3)	Op Temp (°C)	Device Marking (4/5)	Samples
LM2930T-5.0	OBSOLETE	TO-220	NDE	3		TBD	Call TI	Call TI	-40 to 85	LM2930T -5.0 P+	
LM2930T-5.0/NOPB	ACTIVE	TO-220	NDE	3	45	Green (RoHS & no Sb/Br)	CU SN	Level-1-NA-UNLIM	-40 to 85	LM2930T -5.0 P+	Samples
LM2930T-8.0	OBSOLETE	TO-220	NDE	3		TBD	Call TI	Call TI	-40 to 85	LM2930T 8.0 P+	
LM2930T-8.0/NOPB	OBSOLETE	TO-220	NDE	3		TBD	Call TI	Call TI	-40 to 85	LM2930T 8.0 P+	

(1) The marketing status values are defined as follows:

ACTIVE: Product device recommended for new designs.

LIFEBUY: TI has announced that the device will be discontinued, and a lifetime-buy period is in effect.

NRND: Not recommended for new designs. Device is in production to support existing customers, but TI does not recommend using this part in a new design.

PREVIEW: Device has been announced but is not in production. Samples may or may not be available.

OBSOLETE: TI has discontinued the production of the device.

(2) Eco Plan - The planned eco-friendly classification: Pb-Free (RoHS), Pb-Free (RoHS Exempt), or Green (RoHS & no Sb/Br) - please check <http://www.ti.com/productcontent> for the latest availability information and additional product content details.

TBD: The Pb-Free/Green conversion plan has not been defined.

Pb-Free (RoHS): TI's terms "Lead-Free" or "Pb-Free" mean semiconductor products that are compatible with the current RoHS requirements for all 6 substances, including the requirement that lead not exceed 0.1% by weight in homogeneous materials. Where designed to be soldered at high temperatures, TI Pb-Free products are suitable for use in specified lead-free processes.

Pb-Free (RoHS Exempt): This component has a RoHS exemption for either 1) lead-based flip-chip solder bumps used between the die and package, or 2) lead-based die adhesive used between the die and leadframe. The component is otherwise considered Pb-Free (RoHS compatible) as defined above.

Green (RoHS & no Sb/Br): TI defines "Green" to mean Pb-Free (RoHS compatible), and free of Bromine (Br) and Antimony (Sb) based flame retardants (Br or Sb do not exceed 0.1% by weight in homogeneous material)

(3) MSL, Peak Temp. - The Moisture Sensitivity Level rating according to the JEDEC industry standard classifications, and peak solder temperature.

(4) There may be additional marking, which relates to the logo, the lot trace code information, or the environmental category on the device.

(5) Multiple Device Markings will be inside parentheses. Only one Device Marking contained in parentheses and separated by a "~" will appear on a device. If a line is indented then it is a continuation of the previous line and the two combined represent the entire Device Marking for that device.

(6) Lead/Ball Finish - Orderable Devices may have multiple material finish options. Finish options are separated by a vertical ruled line. Lead/Ball Finish values may wrap to two lines if the finish value exceeds the maximum column width.

Important Information and Disclaimer: The information provided on this page represents TI's knowledge and belief as of the date that it is provided. TI bases its knowledge and belief on information provided by third parties, and makes no representation or warranty as to the accuracy of such information. Efforts are underway to better integrate information from third parties. TI has taken and continues to take reasonable steps to provide representative and accurate information but may not have conducted destructive testing or chemical analysis on incoming materials and chemicals. TI and TI suppliers consider certain information to be proprietary, and thus CAS numbers and other limited information may not be available for release.

In no event shall TI's liability arising out of such information exceed the total purchase price of the TI part(s) at issue in this document sold by TI to Customer on an annual basis.

NDE0003B

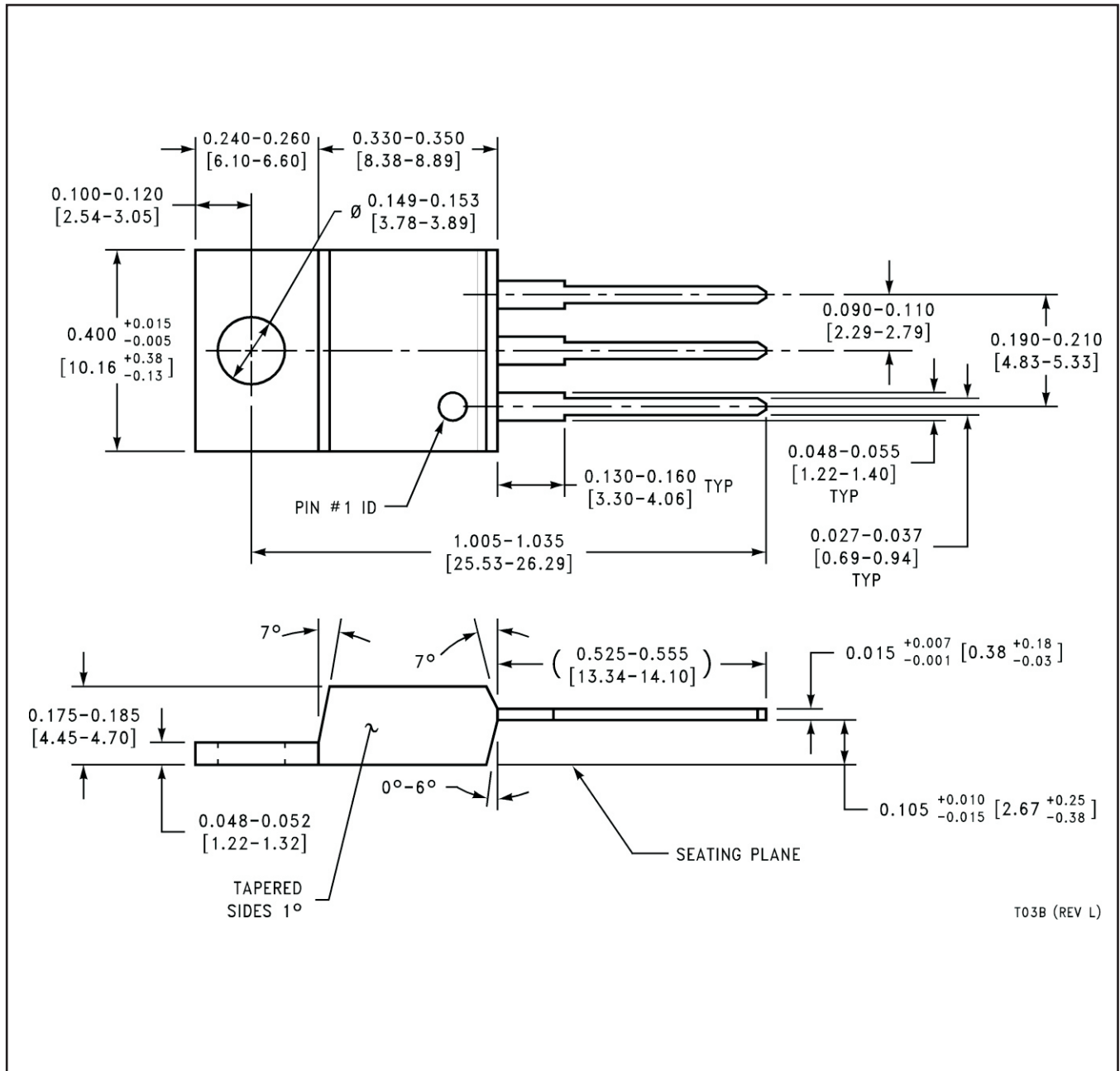

IMPORTANT NOTICE

Texas Instruments Incorporated and its subsidiaries (TI) reserve the right to make corrections, enhancements, improvements and other changes to its semiconductor products and services per JESD46, latest issue, and to discontinue any product or service per JESD48, latest issue. Buyers should obtain the latest relevant information before placing orders and should verify that such information is current and complete. All semiconductor products (also referred to herein as "components") are sold subject to TI's terms and conditions of sale supplied at the time of order acknowledgment.

TI warrants performance of its components to the specifications applicable at the time of sale, in accordance with the warranty in TI's terms and conditions of sale of semiconductor products. Testing and other quality control techniques are used to the extent TI deems necessary to support this warranty. Except where mandated by applicable law, testing of all parameters of each component is not necessarily performed.

TI assumes no liability for applications assistance or the design of Buyers' products. Buyers are responsible for their products and applications using TI components. To minimize the risks associated with Buyers' products and applications, Buyers should provide adequate design and operating safeguards.

TI does not warrant or represent that any license, either express or implied, is granted under any patent right, copyright, mask work right, or other intellectual property right relating to any combination, machine, or process in which TI components or services are used. Information published by TI regarding third-party products or services does not constitute a license to use such products or services or a warranty or endorsement thereof. Use of such information may require a license from a third party under the patents or other intellectual property of the third party, or a license from TI under the patents or other intellectual property of TI.

Reproduction of significant portions of TI information in TI data books or data sheets is permissible only if reproduction is without alteration and is accompanied by all associated warranties, conditions, limitations, and notices. TI is not responsible or liable for such altered documentation. Information of third parties may be subject to additional restrictions.

Resale of TI components or services with statements different from or beyond the parameters stated by TI for that component or service voids all express and any implied warranties for the associated TI component or service and is an unfair and deceptive business practice. TI is not responsible or liable for any such statements.

Buyer acknowledges and agrees that it is solely responsible for compliance with all legal, regulatory and safety-related requirements concerning its products, and any use of TI components in its applications, notwithstanding any applications-related information or support that may be provided by TI. Buyer represents and agrees that it has all the necessary expertise to create and implement safeguards which anticipate dangerous consequences of failures, monitor failures and their consequences, lessen the likelihood of failures that might cause harm and take appropriate remedial actions. Buyer will fully indemnify TI and its representatives against any damages arising out of the use of any TI components in safety-critical applications.

In some cases, TI components may be promoted specifically to facilitate safety-related applications. With such components, TI's goal is to help enable customers to design and create their own end-product solutions that meet applicable functional safety standards and requirements. Nonetheless, such components are subject to these terms.

No TI components are authorized for use in FDA Class III (or similar life-critical medical equipment) unless authorized officers of the parties have executed a special agreement specifically governing such use.

Only those TI components which TI has specifically designated as military grade or "enhanced plastic" are designed and intended for use in military/aerospace applications or environments. Buyer acknowledges and agrees that any military or aerospace use of TI components which have **not** been so designated is solely at the Buyer's risk, and that Buyer is solely responsible for compliance with all legal and regulatory requirements in connection with such use.

TI has specifically designated certain components as meeting ISO/TS16949 requirements, mainly for automotive use. In any case of use of non-designated products, TI will not be responsible for any failure to meet ISO/TS16949.

Products

Audio	www.ti.com/audio
Amplifiers	amplifier.ti.com
Data Converters	dataconverter.ti.com
DLP® Products	www.dlp.com
DSP	dsp.ti.com
Clocks and Timers	www.ti.com/clocks
Interface	interface.ti.com
Logic	logic.ti.com
Power Mgmt	power.ti.com
Microcontrollers	microcontroller.ti.com
RFID	www.ti-rfid.com
OMAP Applications Processors	www.ti.com/omap
Wireless Connectivity	www.ti.com/wirelessconnectivity

Applications



Automotive and Transportation	www.ti.com/automotive
Communications and Telecom	www.ti.com/communications
Computers and Peripherals	www.ti.com/computers
Consumer Electronics	www.ti.com/consumer-apps
Energy and Lighting	www.ti.com/energy
Industrial	www.ti.com/industrial
Medical	www.ti.com/medical
Security	www.ti.com/security
Space, Avionics and Defense	www.ti.com/space-avionics-defense
Video and Imaging	www.ti.com/video

TI E2E Community







e2e.ti.com

Looking for pricing, stock, or lifecycle information?

Click below to explore more details on WIN SOURCE:

-  [View LM2930SX-5.0 on WIN SOURCE](#)
-  [Texas Instruments](#) Information

Optimize Your Supply Chain with WIN SOURCE Solutions

-  Global Sourcing Solution
-  Obsolete Management
-  Cost Control Management
-  Shortage Management
-  Alternative Solution
-  Excess Inventory Management