



THE DATASHEET OF LM317MDCY



LM317M 3-Terminal Adjustable Regulator

1 Features

- Output Voltage Range Adjustable from 1.25-V to 37-V
- Output Current Greater Than 500-mA
- Internal Short-Circuit Current Limiting
- Thermal-Overload Protection
- Output Safe-Area Compensation
- Q Devices Meet Automotive Performance Requirements
- Customer-Specific Configuration Control Can Be Supported for Q Devices Along With Major-Change Approval

2 Applications

- Electronic Point-of-Sales
- Medical/Health/Fitness Applications
- Printers
- Appliances/White Goods
- TV/Set-Top Box

3 Description

The LM317M is an adjustable 3-terminal positive voltage regulator capable of supplying more than 500-mA over an output-voltage range of 1.25-V to 37-V. The LM317M is exceptionally easy to use and requires only two external resistors to set the output. Furthermore, both line and load regulation are better than standard fixed regulators.

In addition to having higher performance than fixed regulators, the LM317M includes on-chip current limiting, thermal-overload protection, and safe-operating-area protection. All overload protection remains fully functional if the ADJUST terminal is disconnected.

The LM317 is a floating regulator meaning there is no device ground terminal. Quiescent current flows to the load instead of being wasted flowing to ground. Regulated output voltage of hundreds of volts is possible if the maximum input to output differential does not exceed 40-V at any time. Device can be used as a floating current source controlled by a single resistor.

Normally, no capacitors are needed unless the device is more than six inches from the input filter capacitors, in which case an input bypass capacitor of any type is needed. An optional electrolytic or tantalum output capacitor can be added to improve transient response. Ceramic output capacitors can be used but output ringing may be present on transients. The ADJUST terminal can be bypassed with any type of capacitor to achieve high ripple-rejection ratios, which are difficult to achieve with standard three-terminal regulators.

Device Information

ORDER NUMBER	PACKAGE	BODY SIZE
LM317MDCY	SOT-223 (3)	6,5mm x 3,5mm
LM317MKVURG3	TO-252 (3)	6,6mm x 6,1mm
LM317MKTPR	PFM (3)	6,04mm x 6,15mm

DCY (SOT-223) PACKAGE
(TOP VIEW)

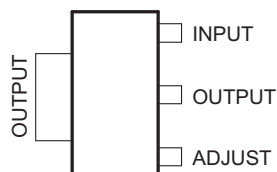

KTP (PFM) PACKAGE
(TOP VIEW)

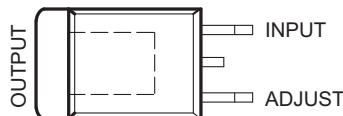

KVU (TO-252) PACKAGE
(TOP VIEW)

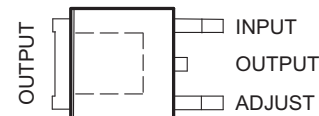

Table of Contents

1 Features	1	7.3 Feature Description	7
2 Applications	1	7.4 Device Functional Modes	8
3 Description	1	8 Applications and Implementation	9
4 Revision History	2	8.1 Application Information	9
5 Terminal Configuration and Functions	3	8.2 Typical Application	9
6 Specifications	3	9 Power Supply Recommendations	11
6.1 Absolute Maximum Ratings	3	10 Layout	11
6.2 Handling Ratings	3	10.1 Layout Guidelines	11
6.3 Recommended Operating Conditions	3	10.2 Layout Example	11
6.4 Thermal Information	4	11 Device and Documentation Support	12
6.5 Electrical Characteristics	4	11.1 Trademarks	12
6.6 Typical Characteristics	5	11.2 Electrostatic Discharge Caution	12
7 Detailed Description	7	11.3 Glossary	12
7.1 Overview	7	12 Mechanical, Packaging, and Orderable Information	12
7.2 Functional Block Diagram	7		

4 Revision History

Changes from Revision O (July 2006) to Revision P	Page
• Removed Ordering Information Table	1
• Clarified T_J package field	3

5 Terminal Configuration and Functions

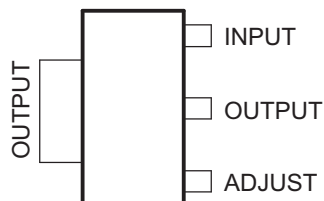
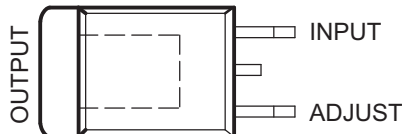
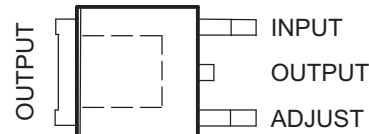
**DCY (SOT-223) PACKAGE
(TOP VIEW)**

**KTP (PFM) PACKAGE
(TOP VIEW)**

**KVU (TO-252) PACKAGE
(TOP VIEW)**

Terminal Functions

TERMINAL		I/O	DESCRIPTION
NAME	NO.		
ADJUST	1	I	Output feedback voltage
OUTPUT	2	O	Regulated output voltage
INPUT	3	–	Input supply voltage, 2.5 to 40V relative to OUTPUT terminal

6 Specifications

6.1 Absolute Maximum Ratings⁽¹⁾

over operating temperature range (unless otherwise noted)

		MIN	MAX	UNIT
$V_I - V_O$	Input-to-output differential voltage		40	V
T_J	Operating virtual junction temperature		150	°C

(1) Stresses beyond those listed under "absolute maximum ratings" may cause permanent damage to the device. These are stress ratings only, and functional operation of the device at these or any other conditions beyond those indicated under "recommended operating conditions" is not implied. Exposure to absolute-maximum-rated conditions for extended periods may affect device reliability.

6.2 Handling Ratings

		MIN	MAX	UNIT
T_{STG}	Storage temperature range	–65	150	°C

6.3 Recommended Operating Conditions

		MIN	MAX	UNIT	
$V_I - V_O$	Input-to-output voltage differential	2.5	37	V	
I_O	Output current	0.01	0.5	A	
T_J	Operating virtual junction temperature		0	125	°C
			–40	125	

6.4 Thermal Information

THERMAL METRIC ⁽¹⁾		LM317M	UNIT
		DCY	
		4 TERMINALS	
R _{θJA}	Junction-to-ambient thermal resistance	60.2	°C/W
R _{θJctop}	Junction-to-case (top) thermal resistance	42.0	
R _{θJB}	Junction-to-board thermal resistance	9.4	
ψ _{JT}	Junction-to-top characterization parameter	3.4	
ψ _{JB}	Junction-to-board characterization parameter	9.3	
R _{θJcbot}	Junction-to-case (bottom) thermal resistance	n/a	

(1) For more information about traditional and new thermal metrics, see the *IC Package Thermal Metrics* application report, [SPRA953](#).

6.5 Electrical Characteristics

over recommended operating virtual-junction temperature range, $V_I - V_O = 5\text{ V}$, $I_O = 0.1\text{ A}$ (unless otherwise noted)

PARAMETER	TEST CONDITIONS ⁽¹⁾	MIN	TYP	MAX	UNIT
Line regulation ⁽²⁾	$V_I - V_O = 3\text{ V to }40\text{ V}$	$T_J = 25^\circ\text{C}$	0.01	0.04	%V
		Full temperature range	0.02	0.07	
Load regulation	$I_O = 10\text{ mA to }500\text{ mA}$	$T_J = 25^\circ\text{C}$	0.1	0.5	%V _O
		Full temperature range	0.3	1.5	
ADJUST terminal current			50	100	μA
Change in ADJUST terminal current	$V_I - V_O = 3\text{ V to }40\text{ V}$, $I_O = 10\text{ mA to }500\text{ mA}$		0.2	5	μA
Reference voltage	$V_I - V_O = 3\text{ V to }40\text{ V}$, $I_O = 10\text{ mA to }500\text{ mA}$	1.2	1.25	1.3	V
Output-voltage temperature stability			0.7		%
Minimum load current to maintain regulation			3.5	10	mA
Maximum output current	$V_I - V_O \leq 15\text{ V}$	500	900		mA
	$V_I - V_O = 40\text{ V}$, $P_D \leq P_{D(\text{max})}$, $T_J = 25^\circ\text{C}$	150	250		
RMS output noise voltage (% of V _O)	$f = 10\text{ Hz to }10\text{ kHz}$, $T_J = 25^\circ\text{C}$		0.003		%V _O
Ripple rejection	$V_O = 10\text{ V}$, $f = 120\text{ Hz}$, $T_J = 25^\circ\text{C}$	$C_{\text{ADJ}} = 0^{(3)}$		65	dB
		$C_{\text{ADJ}} = 10\text{ }\mu\text{F}^{(3)}$	66	80	
Long-term stability	$T_J = 25^\circ\text{C}$		0.3	1	%/1k hrs

(1) Pulse-testing techniques are used to maintain the junction temperature as close to the ambient temperature as possible.

(2) Line voltage regulation is expressed here as the percentage change in output voltage per 1-V change at the input.

(3) C_{ADJ} is connected between the ADJUST terminal and ground.

6.6 Typical Characteristics

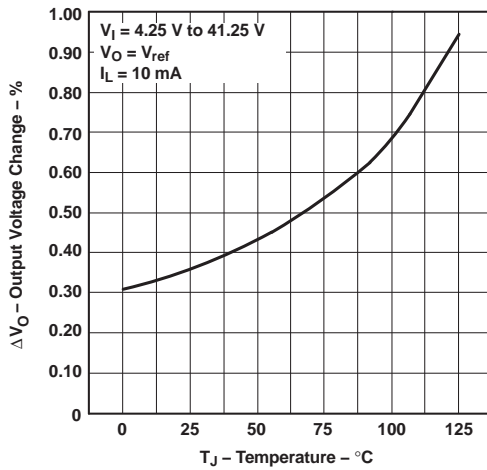

Figure 1. Line Regulation vs Temperature

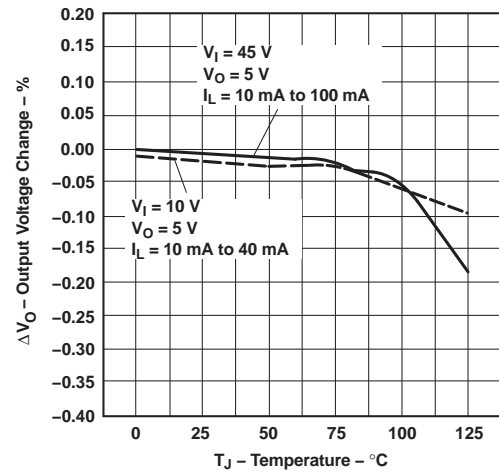

Figure 2. Load Regulation vs Temperature

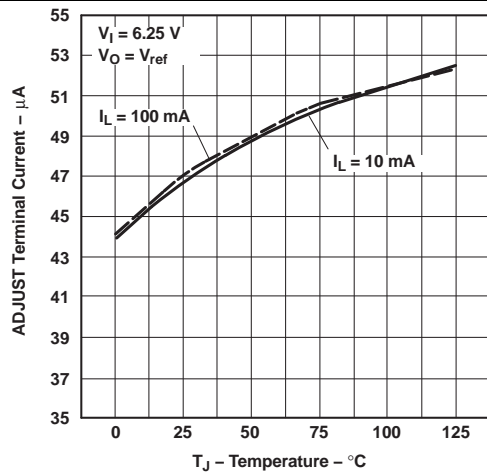

Figure 3. Adjust Terminal Current vs Temperature

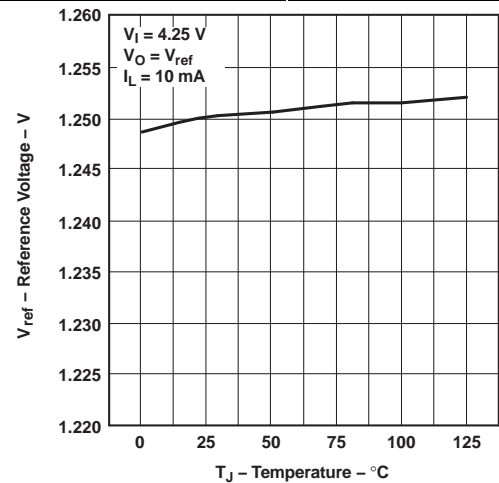

Figure 4. Temperature Stability vs Temperature

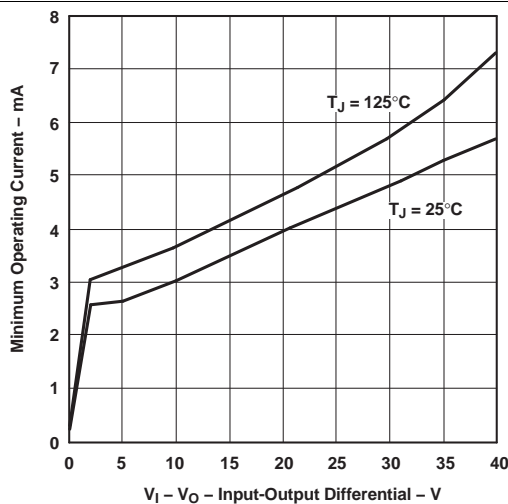

Figure 5. Minimum Operating Current vs Input-output Differential Voltage

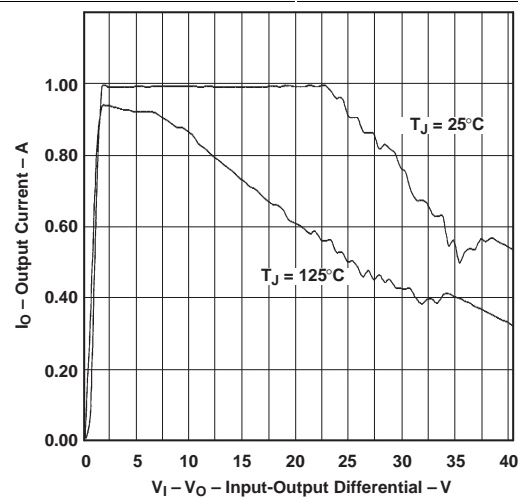

Figure 6. Output Current Limit vs Input-output Differential Voltage

Typical Characteristics (continued)

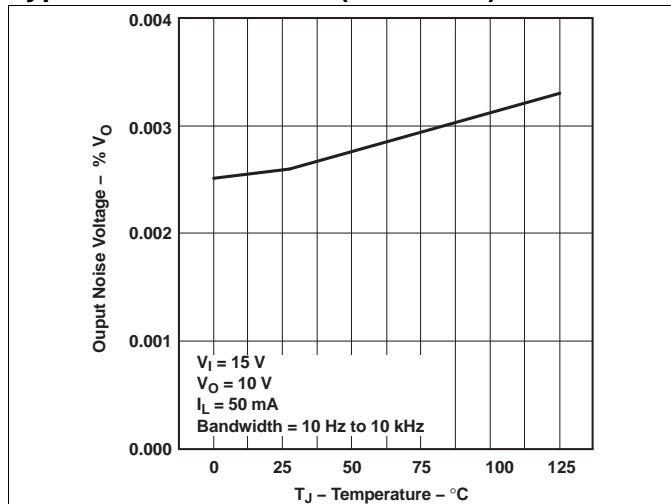

Figure 7. Output Noise Voltage vs Temperature

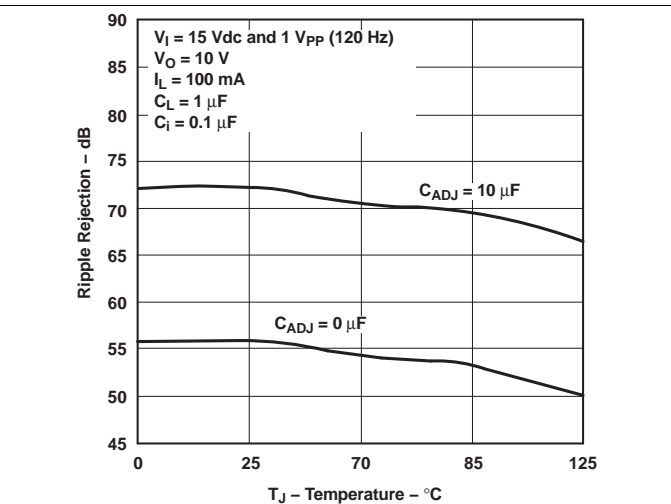

Figure 8. Ripple Rejection vs Temperature

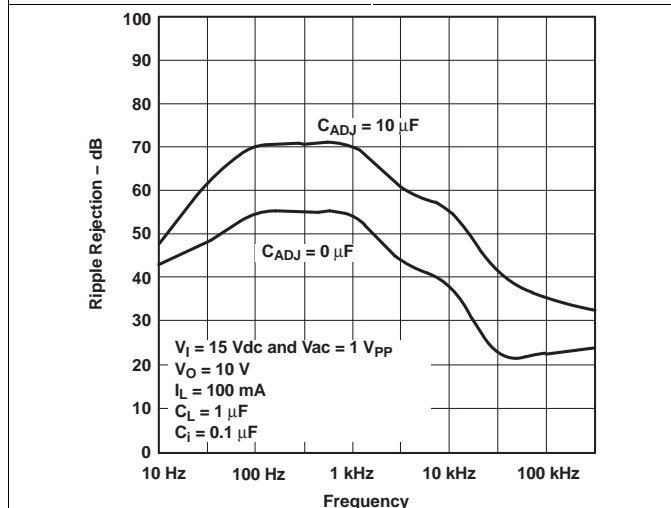

Figure 9. Ripple Rejection vs Frequency

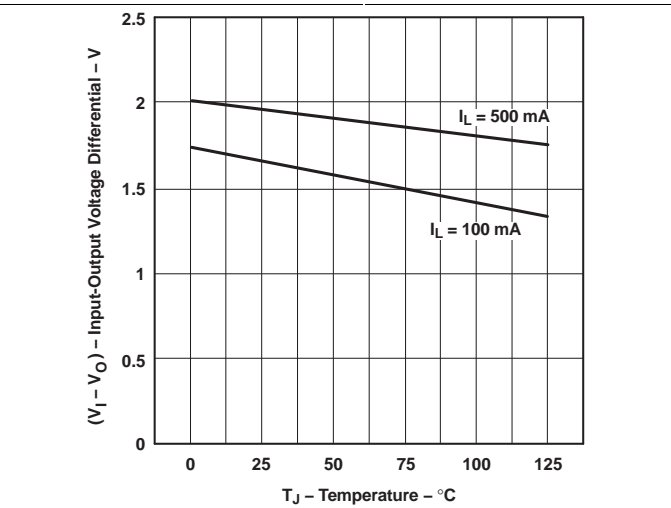

Figure 10. Input-output Voltage Differential vs Temperature

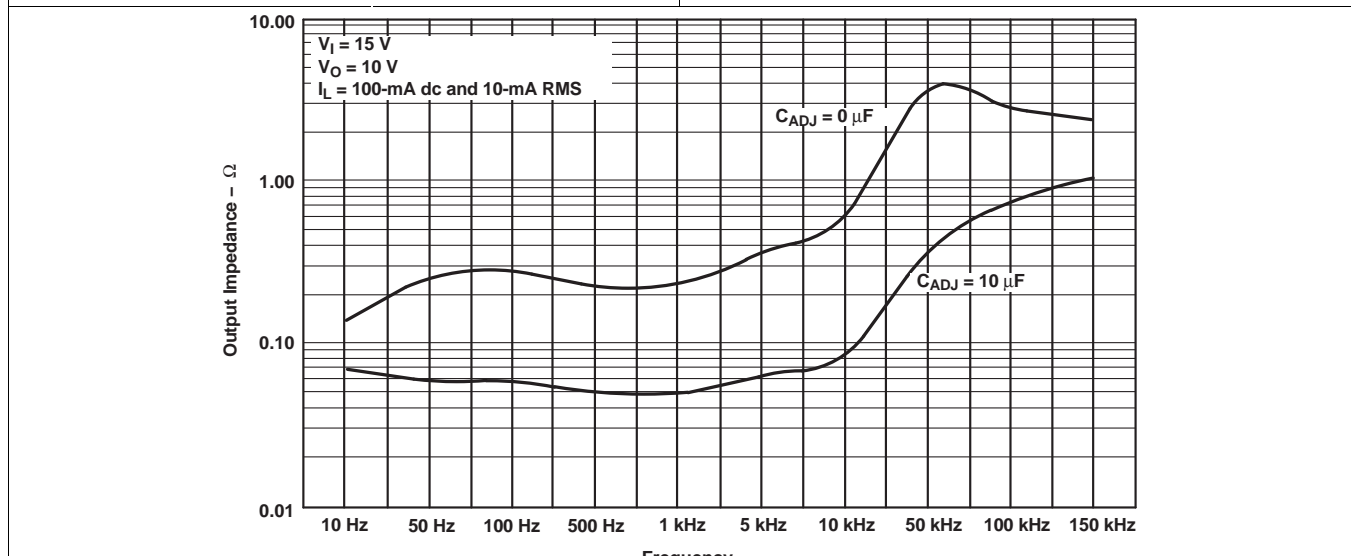

Figure 11. Output Impedance vs Frequency

7 Detailed Description

7.1 Overview

The LM317 is a 500-mA linear regulator with high voltage tolerance up to 40-V. The device has a feedback voltage that is relative to the output instead of ground. This ungrounded design allows the LM317 to have superior line and load regulation. It also allows the LM317 to be used as a current source or current sink using a single resistor. Any output voltage output voltage from 1.25-V to 37-V can be obtained by using two resistors. The bias current of the device, up to 10-mA, flows to the output; this current must be used by the load or the feedback resistors. The power dissipation will be the product of pass element voltage and current, mathematically:

$$(V[\text{input}] - V[\text{output}]) \times I[\text{output}] \quad (1)$$

The application heat sink must be able to absorb this power.

7.2 Functional Block Diagram

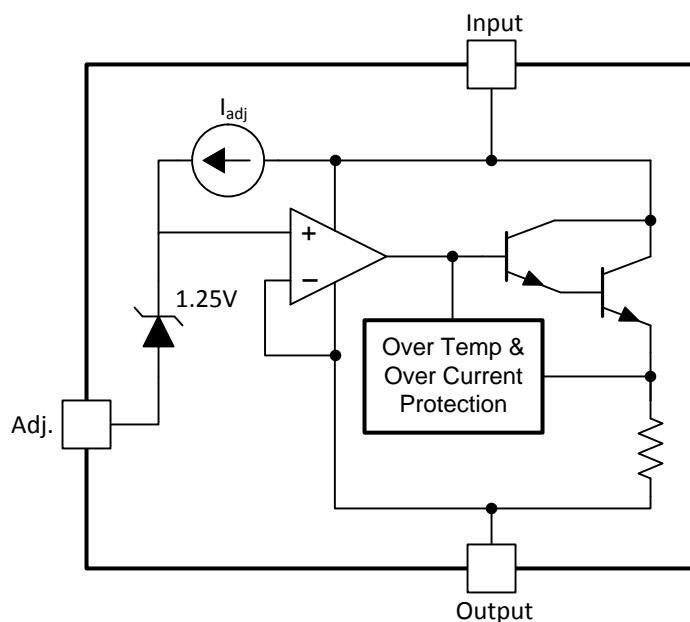

7.3 Feature Description

7.3.1 NPN Darlington Output Drive

NPN Darlington output topology provides naturally low output impedance and an output capacitor is optional. To support maximum current and lowest temperature, 2.5-V headroom is recommended ($V_I - V_O$).

7.3.2 Overload Block

Current limit scales with higher voltage to provide a safe operation area for the NPN pass elements. Over temperature shutdown protects against overload or under heat sinking.

7.3.3 Programmable Feedback

Op amp with 1.25-V offset input at the ADJUST terminal provides easy output voltage or current (not both) programming. For current regulation applications, a single resistor whose resistance value is $1.25V/I_{OUT}$ and power rating is greater than $(1.25V)^2/R$ should be used. For voltage regulation applications, two resistors set the output voltage. See the [Typical Application](#) section for schematic and resistor formula.

Feature Description (continued)

7.3.4 Current Sources

The two current sources represent the typical 'adjust terminal current' and typical 'minimum current for regulation'.

7.4 Device Functional Modes

7.4.1 Normal operation

The device OUTPUT terminal will source current necessary to make OUTPUT terminal 1.25-V greater than ADJUST terminal to provide output regulation.

7.4.2 Operation With Low Input Voltage

The device requires up to 2.5-V headroom ($V_{in} - V_{out}$) to operate in regulation. With less headroom, the device may drop out and OUTPUT voltage will be INPUT voltage minus drop out voltage.

7.4.3 Operation at Light Loads

The device passes its bias current to the OUTPUT terminal. The load or feedback must consume this minimum current for regulation or the output may be too high.

7.4.4 Operation In Self Protection

When an overload occurs the device will shut down Darlington NPN output stage or reduce the output current to prevent device damage. The device will automatically reset from the overload. The output may be reduced or alternate between on and off until the overload is removed.

7.4.5 Operation at Light Loads

The device passes its bias current to the OUTPUT terminal. The load or feedback must consume this minimum current for regulation or the output may be too high.

8 Applications and Implementation

8.1 Application Information

The LM317M is a linear voltage regulator. The feedback is the output terminal to adjust terminal differential. The output voltage can be set to any value from 1.25-V to V_{out} maximum with two resistors.

8.2 Typical Application

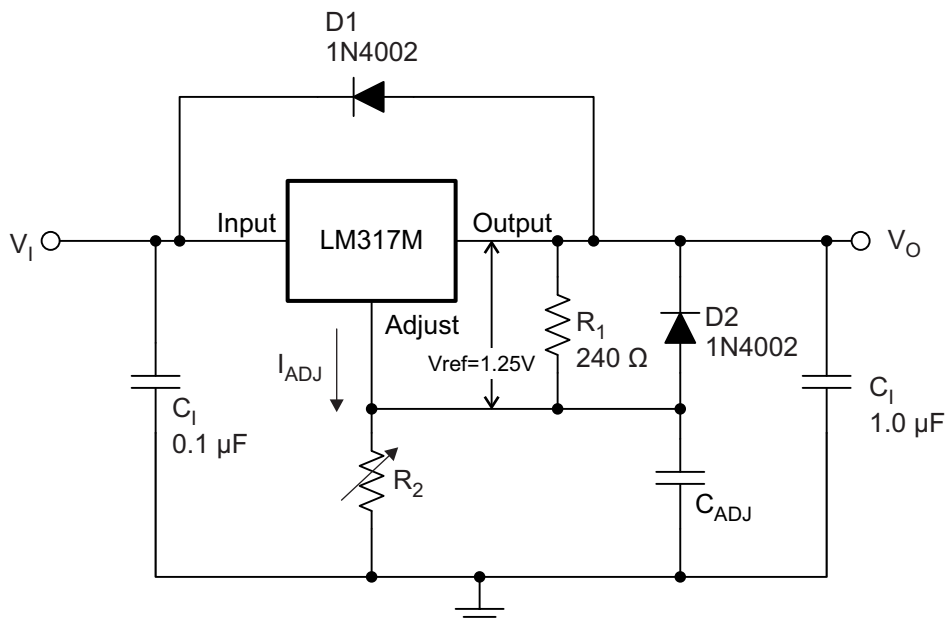

8.2.1 Design Requirements

For this design example, use the parameters listed in [Table 1](#).

Table 1. Design Parameters

DESIGN PARAMETER	EXAMPLE VALUE
Input voltage range	(Output Voltage + 2.5V) to 37V
Output voltage	$V_{ref} \times (1 + R_2/R_1) + I_{adj} \times R_2$

8.2.2 Detailed Design Procedure

8.2.2.1 Input Capacitor

An input capacitor is not required, but it is recommended, particularly if the regulator is not in close proximity to the power-supply filter capacitors. A 0.1-µF ceramic or 1-µF tantalum provides sufficient bypassing for most applications, especially when adjustment and output capacitors are used.

8.2.2.2 Output Capacitor

An output capacitor improves transient response, but it not needed for stability.

8.2.2.3 Feedback Resistors

The feedback resistor set the output voltage using [Equation 2](#).

$$V_{ref} \times (1 + R_2/R_1) + I_{adj} \times R_2 \quad (2)$$

8.2.2.4 Adjustment Terminal Capacitor

The optional adjustment terminal capacitor will improve ripple rejection by preventing the amplification of the ripple. When capacitor is used and $V_{OUT} > 6V$, a protection diode from adjust to output is recommended.

8.2.2.5 Protection Diodes

If the input is shorted to ground during a fault condition, protection diode (D1) prevents discharge through the LM317M. If the output is shorted to ground during a fault condition, protection diode (D2) prevents adjust terminal capacitor discharge through the LM317M.

8.2.2.6 Design Options and Parameters

Common Linear Regulator designs are concerned with the following parameters:

- Input voltage range
- Input Capacitor range
- Output voltage
- Output current rating
- Output capacitor range
- Input Short Protection
- Stability
- Ripple Rejection

8.2.2.7 Output Voltage

V_o is calculated as shown:

$$V_o = V_{ref} \times \left(1 + \frac{R_2}{R_1}\right) + (I_{adj} \times R_2) \tag{3}$$

Because I_{adj} typically is 50- μ A, it is negligible in most applications.

8.2.2.8 Ripple Rejection

C_{ADJ} is used to improve ripple rejection; it prevents amplification of the ripple as the output voltage is adjusted higher. If C_{ADJ} is used, it is best to include protection diodes.

8.2.2.9 Input Short Protection

If the input is shorted to ground during a fault condition, protection diodes provide measures to prevent the possibility of external capacitors discharging through low-impedance paths in the IC. By providing low-impedance discharge paths for C_o and C_{ADJ} , respectively, D1 and D2 prevent the capacitors from discharging into the output of the regulator.

8.2.3 Application Curves

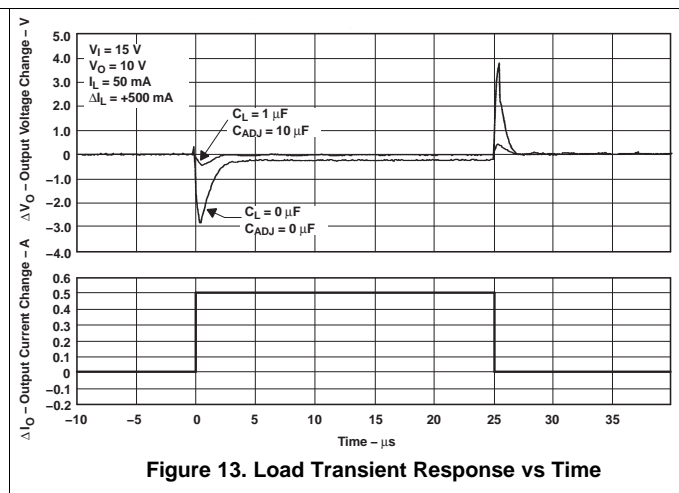
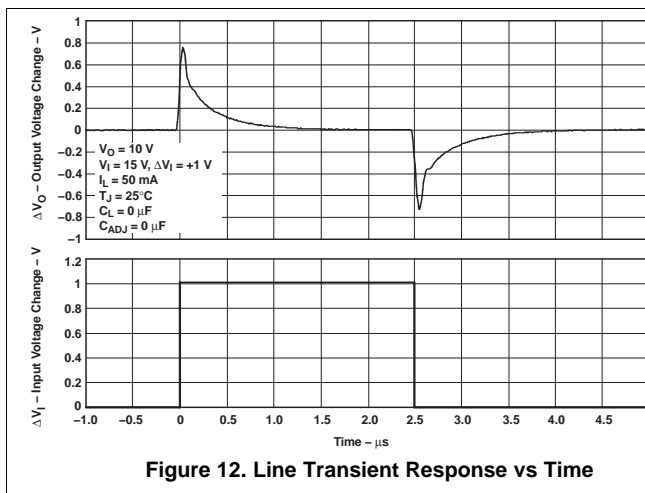

9 Power Supply Recommendations

The LM317 is designed to operate from an input voltage supply range between 2.5-V to 40-V greater than the output voltage. If the device is more than six inches from the input filter capacitors, an input bypass capacitor, 0.1- μ F or greater, of any type is needed for stability.

10 Layout

10.1 Layout Guidelines

- It is recommended that the input terminal be bypassed to ground with a bypass-capacitor.
- The optimum placement is closest to the VIN and GND terminals of the device. Care must be taken to minimize the loop area formed by the bypass-capacitor connection, the VIN terminal, and the GND terminal of the IC.
- For operation at full rated load, it is recommended to use wide trace lengths to eliminate IR drop and heat dissipation.

10.2 Layout Example

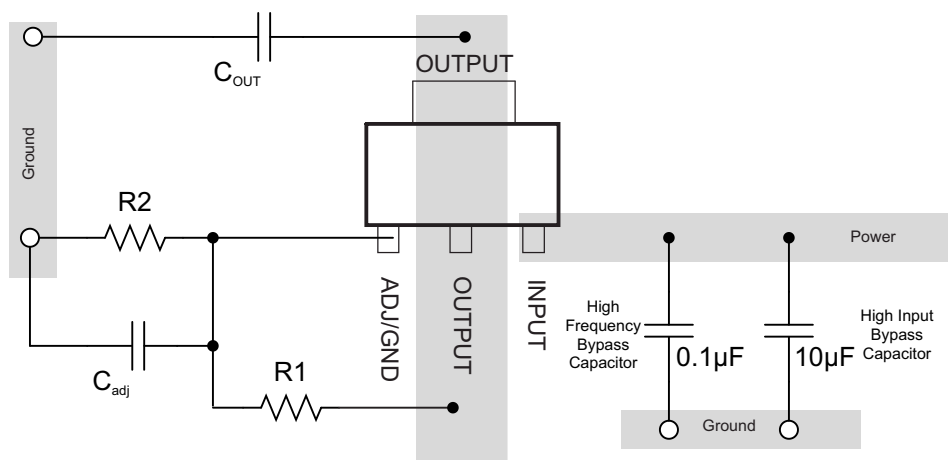

11 Device and Documentation Support

11.1 Trademarks

All trademarks are the property of their respective owners.

11.2 Electrostatic Discharge Caution



This integrated circuit can be damaged by ESD. Texas Instruments recommends that all integrated circuits be handled with appropriate precautions. Failure to observe proper handling and installation procedures can cause damage.

ESD damage can range from subtle performance degradation to complete device failure. Precision integrated circuits may be more susceptible to damage because very small parametric changes could cause the device not to meet its published specifications.

11.3 Glossary

[SLYZ022](#) — *TI Glossary*.

This glossary lists and explains terms, acronyms and definitions.

12 Mechanical, Packaging, and Orderable Information

The following pages include mechanical packaging and orderable information. This information is the most current data available for the designated devices. This data is subject to change without notice and revision of this document. For browser-based versions of this data sheet, refer to the left-hand navigation.

PACKAGING INFORMATION

Orderable Device	Status (1)	Package Type	Package Drawing	Pins	Package Qty	Eco Plan (2)	Lead/Ball Finish (6)	MSL Peak Temp (3)	Op Temp (°C)	Device Marking (4/5)	Samples
LM317MDCY	ACTIVE	SOT-223	DCY	4	80	Green (RoHS & no Sb/Br)	CU SN	Level-2-260C-1 YEAR	-40 to 125	L4	Samples
LM317MDCYG3	ACTIVE	SOT-223	DCY	4	80	Green (RoHS & no Sb/Br)	CU SN	Level-2-260C-1 YEAR	-40 to 125	L4	Samples
LM317MDCYR	ACTIVE	SOT-223	DCY	4	2500	Green (RoHS & no Sb/Br)	CU SN	Level-2-260C-1 YEAR	-40 to 125	L4	Samples
LM317MDCYRG3	ACTIVE	SOT-223	DCY	4	2500	Green (RoHS & no Sb/Br)	CU SN	Level-2-260C-1 YEAR	-40 to 125	L4	Samples
LM317MKVURG3	ACTIVE	TO-252	KVU	3	2500	Green (RoHS & no Sb/Br)	CU SN	Level-3-260C-168 HR	-40 to 125	LM317M	Samples
LM317MQDCYR	ACTIVE	SOT-223	DCY	4	2500	Green (RoHS & no Sb/Br)	CU NIPDAU	Level-2-260C-1 YEAR	-40 to 125	L5	Samples
LM317MQDCYRG4	ACTIVE	SOT-223	DCY	4	2500	Green (RoHS & no Sb/Br)	CU NIPDAU	Level-2-260C-1 YEAR	-40 to 125	L5	Samples

(1) The marketing status values are defined as follows:

ACTIVE: Product device recommended for new designs.

LIFEBUY: TI has announced that the device will be discontinued, and a lifetime-buy period is in effect.

NRND: Not recommended for new designs. Device is in production to support existing customers, but TI does not recommend using this part in a new design.

PREVIEW: Device has been announced but is not in production. Samples may or may not be available.

OBSELETE: TI has discontinued the production of the device.

(2) Eco Plan - The planned eco-friendly classification: Pb-Free (RoHS), Pb-Free (RoHS Exempt), or Green (RoHS & no Sb/Br) - please check <http://www.ti.com/productcontent> for the latest availability information and additional product content details.

TBD: The Pb-Free/Green conversion plan has not been defined.

Pb-Free (RoHS): TI's terms "Lead-Free" or "Pb-Free" mean semiconductor products that are compatible with the current RoHS requirements for all 6 substances, including the requirement that lead not exceed 0.1% by weight in homogeneous materials. Where designed to be soldered at high temperatures, TI Pb-Free products are suitable for use in specified lead-free processes.

Pb-Free (RoHS Exempt): This component has a RoHS exemption for either 1) lead-based flip-chip solder bumps used between the die and package, or 2) lead-based die adhesive used between the die and leadframe. The component is otherwise considered Pb-Free (RoHS compatible) as defined above.

Green (RoHS & no Sb/Br): TI defines "Green" to mean Pb-Free (RoHS compatible), and free of Bromine (Br) and Antimony (Sb) based flame retardants (Br or Sb do not exceed 0.1% by weight in homogeneous material)

(3) MSL, Peak Temp. - The Moisture Sensitivity Level rating according to the JEDEC industry standard classifications, and peak solder temperature.

(4) There may be additional marking, which relates to the logo, the lot trace code information, or the environmental category on the device.

⁽⁵⁾ Multiple Device Markings will be inside parentheses. Only one Device Marking contained in parentheses and separated by a "-" will appear on a device. If a line is indented then it is a continuation of the previous line and the two combined represent the entire Device Marking for that device.

⁽⁶⁾ Lead/Ball Finish - Orderable Devices may have multiple material finish options. Finish options are separated by a vertical ruled line. Lead/Ball Finish values may wrap to two lines if the finish value exceeds the maximum column width.

Important Information and Disclaimer:The information provided on this page represents TI's knowledge and belief as of the date that it is provided. TI bases its knowledge and belief on information provided by third parties, and makes no representation or warranty as to the accuracy of such information. Efforts are underway to better integrate information from third parties. TI has taken and continues to take reasonable steps to provide representative and accurate information but may not have conducted destructive testing or chemical analysis on incoming materials and chemicals. TI and TI suppliers consider certain information to be proprietary, and thus CAS numbers and other limited information may not be available for release.

In no event shall TI's liability arising out of such information exceed the total purchase price of the TI part(s) at issue in this document sold by TI to Customer on an annual basis.

TAPE AND REEL INFORMATION

QUADRANT ASSIGNMENTS FOR PIN 1 ORIENTATION IN TAPE



*All dimensions are nominal

Device	Package Type	Package Drawing	Pins	SPQ	Reel Diameter (mm)	Reel Width W1 (mm)	A0 (mm)	B0 (mm)	K0 (mm)	P1 (mm)	W (mm)	Pin1 Quadrant
LM317MDCYR	SOT-223	DCY	4	2500	330.0	12.4	6.55	7.25	1.9	8.0	12.0	Q3
LM317MDCYR	SOT-223	DCY	4	2500	330.0	12.4	7.0	7.42	2.0	8.0	12.0	Q3
LM317MDCYR	SOT-223	DCY	4	2500	330.0	12.4	7.05	7.4	1.9	8.0	12.0	Q3
LM317MKVURG3	TO-252	KVU	3	2500	330.0	16.4	6.9	10.5	2.8	8.0	16.0	Q2
LM317MQDCYR	SOT-223	DCY	4	2500	330.0	12.4	6.83	7.42	1.88	8.0	12.0	Q3
LM317MQDCYRG4	SOT-223	DCY	4	2500	330.0	12.4	6.83	7.42	1.88	8.0	12.0	Q3

TAPE AND REEL BOX DIMENSIONS

*All dimensions are nominal

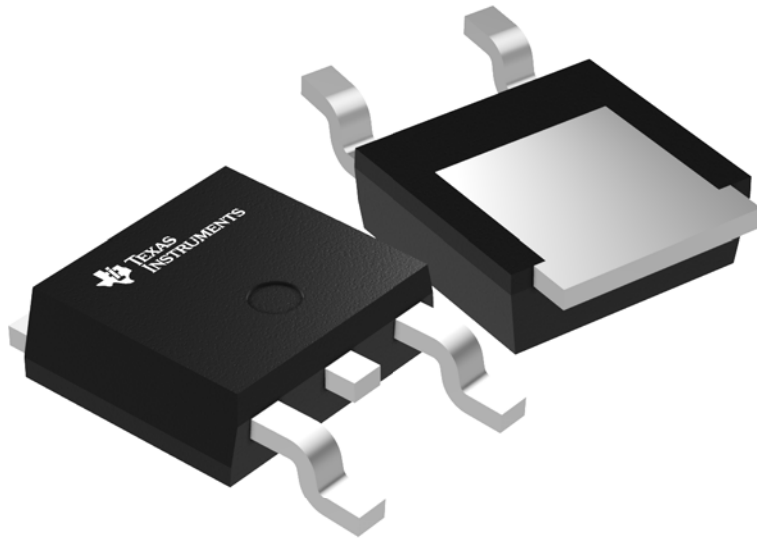
Device	Package Type	Package Drawing	Pins	SPQ	Length (mm)	Width (mm)	Height (mm)
LM317MDCYR	SOT-223	DCY	4	2500	336.0	336.0	48.0
LM317MDCYR	SOT-223	DCY	4	2500	350.0	334.0	47.0
LM317MDCYR	SOT-223	DCY	4	2500	340.0	340.0	38.0
LM317MKVURG3	TO-252	KVU	3	2500	350.0	334.0	47.0
LM317MQDCYR	SOT-223	DCY	4	2500	346.0	346.0	29.0
LM317MQDCYRG4	SOT-223	DCY	4	2500	346.0	346.0	29.0



Images above are just a representation of the package family, actual package may vary.
Refer to the product data sheet for package details.

EXAMPLE BOARD LAYOUT

KVU0003A

TO-252 - 2.52 mm max height

TO-252

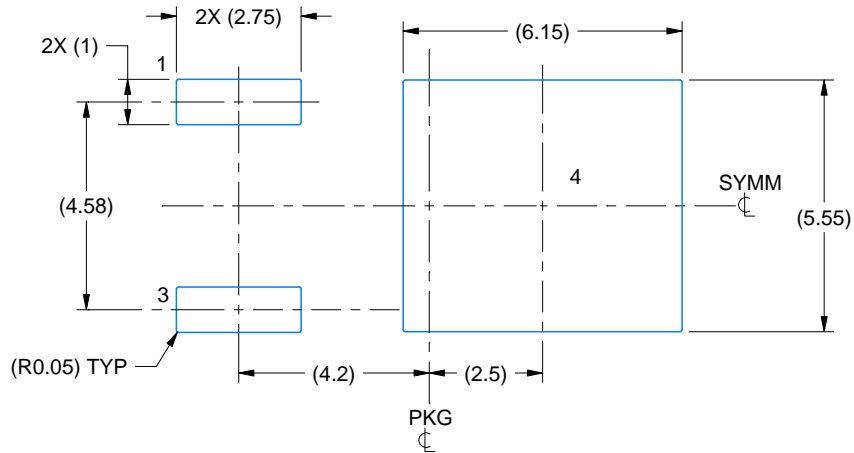

LAND PATTERN EXAMPLE
EXPOSED METAL SHOWN
SCALE:6X

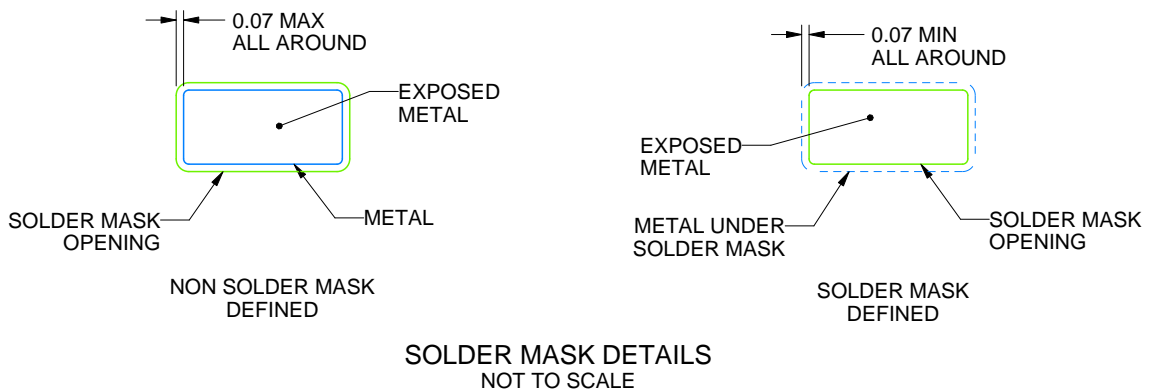

SOLDER MASK DETAILS
NOT TO SCALE

4218915/A 02/2017

NOTES: (continued)

5. This package is designed to be soldered to a thermal pad on the board. For more information, see Texas Instruments literature numbers SLMA002 (www.ti.com/lit/slm002) and SLMA004 (www.ti.com/lit/slma004).
6. Vias are optional depending on application, refer to device data sheet. It is recommended that vias under paste be filled, plugged or tented.

EXAMPLE STENCIL DESIGN

KVU0003A

TO-252 - 2.52 mm max height

TO-252

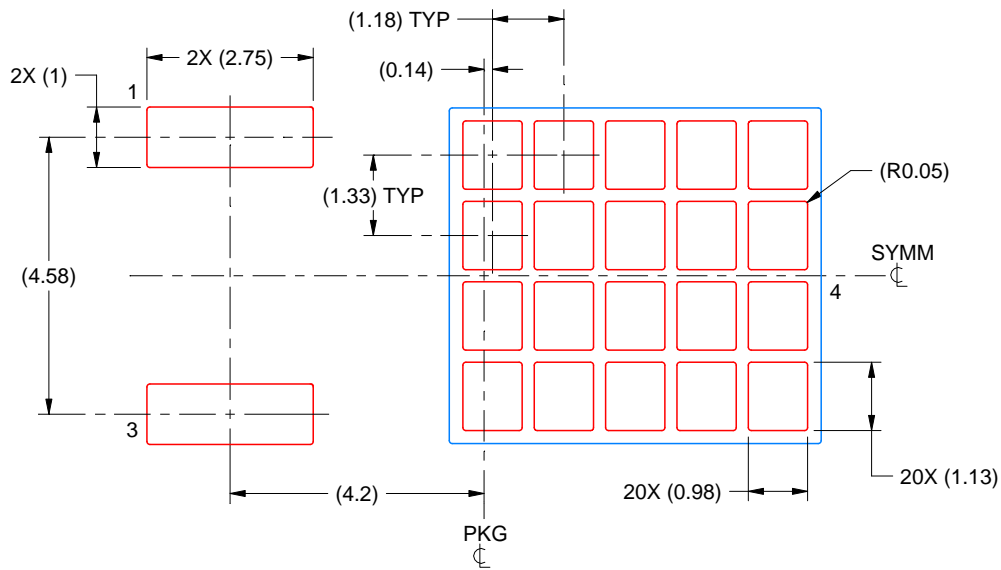

SOLDER PASTE EXAMPLE
BASED ON 0.125 mm THICK STENCIL

EXPOSED PAD
65% PRINTED SOLDER COVERAGE BY AREA
SCALE:8X

4218915/A 02/2017

NOTES: (continued)

7. Laser cutting apertures with trapezoidal walls and rounded corners may offer better paste release. IPC-7525 may have alternate design recommendations.
8. Board assembly site may have different recommendations for stencil design.

DCY (R-PDSO-G4)

PLASTIC SMALL-OUTLINE



- NOTES: A. All linear dimensions are in millimeters (inches).
 B. This drawing is subject to change without notice.
 C. Body dimensions do not include mold flash or protrusion.
 D. Falls within JEDEC TO-261 Variation AA.

DCY (R-PDSO-G4)

PLASTIC SMALL OUTLINE

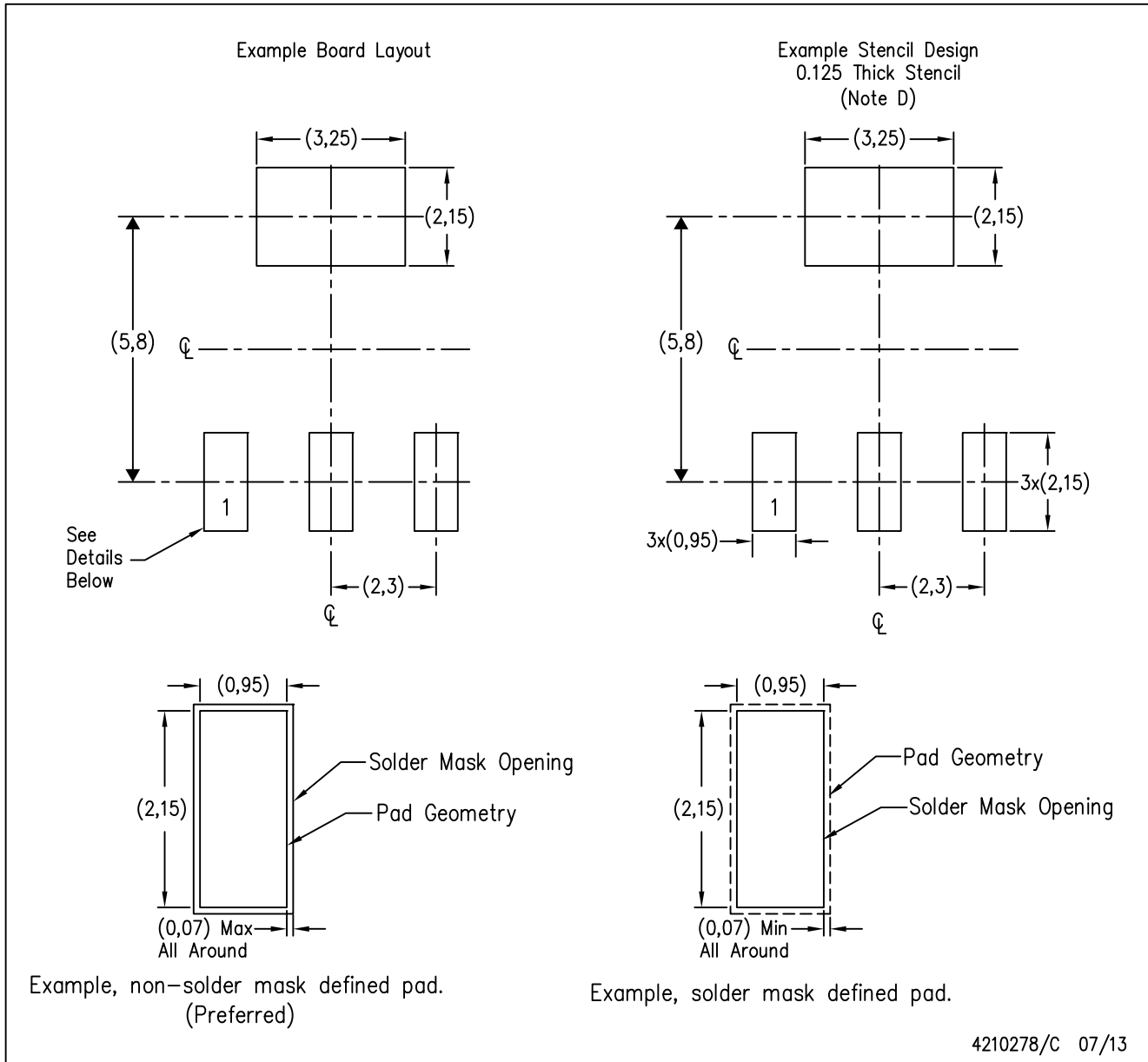

- NOTES:
- A. All linear dimensions are in millimeters.
 - B. This drawing is subject to change without notice.
 - C. Publication IPC-7351 is recommended for alternate designs.
 - D. Laser cutting apertures with trapezoidal walls and also rounding corners will offer better paste release. Customers should contact their board assembly site for stencil recommendations. Refer to IPC 7525 for stencil design considerations.

IMPORTANT NOTICE AND DISCLAIMER

TI PROVIDES TECHNICAL AND RELIABILITY DATA (INCLUDING DATASHEETS), DESIGN RESOURCES (INCLUDING REFERENCE DESIGNS), APPLICATION OR OTHER DESIGN ADVICE, WEB TOOLS, SAFETY INFORMATION, AND OTHER RESOURCES "AS IS" AND WITH ALL FAULTS, AND DISCLAIMS ALL WARRANTIES, EXPRESS AND IMPLIED, INCLUDING WITHOUT LIMITATION ANY IMPLIED WARRANTIES OF MERCHANTABILITY, FITNESS FOR A PARTICULAR PURPOSE OR NON-INFRINGEMENT OF THIRD PARTY INTELLECTUAL PROPERTY RIGHTS.

These resources are intended for skilled developers designing with TI products. You are solely responsible for (1) selecting the appropriate TI products for your application, (2) designing, validating and testing your application, and (3) ensuring your application meets applicable standards, and any other safety, security, or other requirements. These resources are subject to change without notice. TI grants you permission to use these resources only for development of an application that uses the TI products described in the resource. Other reproduction and display of these resources is prohibited. No license is granted to any other TI intellectual property right or to any third party intellectual property right. TI disclaims responsibility for, and you will fully indemnify TI and its representatives against, any claims, damages, costs, losses, and liabilities arising out of your use of these resources.

TI's products are provided subject to TI's Terms of Sale (www.ti.com/legal/termsofsale.html) or other applicable terms available either on ti.com or provided in conjunction with such TI products. TI's provision of these resources does not expand or otherwise alter TI's applicable warranties or warranty disclaimers for TI products.

Mailing Address: Texas Instruments, Post Office Box 655303, Dallas, Texas 75265
Copyright © 2019, Texas Instruments Incorporated

Looking for pricing, stock, or lifecycle information?

Click below to explore more details on WIN SOURCE:

 [View LM317MDCY on WIN SOURCE](#)

 [Texas Instruments](#) Information

Optimize Your Supply Chain with WIN SOURCE Solutions

-  Global Sourcing Solution
-  Obsolete Management
-  Cost Control Management
-  Shortage Management
-  Alternative Solution
-  Excess Inventory Management