



THE DATASHEET OF LM337LZ/NOPB



LM337L 3-Terminal Adjustable Regulator

1 Features

- Adjustable Output Down to 1.2 V
- Ensured 100-mA Output Current
- Line Regulation Typically 0.01%/V
- Load Regulation Typically 0.1%
- Current Limit Constant With Temperature
- Eliminates the Need to Stock Many Voltages
- Standard 3-Pin Transistor Package
- 80-dB Ripple Rejection
- Output is Short Circuit Protected

2 Applications

- Industrial Power Supplies
- Factory Automation Systems
- Building Automation Systems
- PLC Systems
- Instrumentation
- IGBT Drive Negative Gate Supplies
- Networking
- Set-Top Boxes

3 Description

The LM337L is an adjustable 3-pin negative voltage regulator capable of supplying 100 mA over a -1.2V to -37V output range. The LM337L is easy to use and requires only two external resistors to set the output voltage. Both line and load regulation are better than standard fixed regulators. The LM337L is packaged in a standard, easy-to-use TO-92 transistor package.

In addition to higher performance than fixed regulators, the LM337L offers full overload protection. Included on the chip are current limit, thermal overload protection, and safe area protection. All overload protection circuitry remains fully functional even if the adjustment pin is disconnected.

Normally, only a single $1\text{-}\mu\text{F}$ solid tantalum output capacitor is required unless the device is situated more than 6 inches from the input filter capacitors, in which case an input bypass is required. A larger output capacitor can be added to improve transient response. The adjustment pin can be bypassed to achieve very high ripple rejection ratios, which are difficult to achieve with standard 3-pin regulators.

Besides replacing fixed regulators, the LM337L is useful in a wide variety of other applications. Because the regulator is *floating* and monitors only the input-to-output differential voltage, supplies of several hundred volts can be regulated as long as the maximum input-to-output differential is not exceeded.

The LM337L makes a simple adjustable switching regulator, a programmable output regulator, or by connecting a fixed resistor between the adjustment and output, the LM337L can be used as a precision current regulator. Supplies with electronic shutdown can be achieved by clamping the adjustment pin to ground, which programs the output to 1.2 V, where most loads draw little current.

The LM337L is available in a standard TO-92 transistor package and a standard SO-8 surface mount package. The LM337L is rated for operation over a -25°C to 125°C range.

For applications requiring output current in excess of 0.5 A and 1.5 A, The [LM137](#) series may be suitable. For the positive complement, the [LM117](#) and [LM317L](#) series are options.

Device Information⁽¹⁾

PART NUMBER	PACKAGE	BODY SIZE (NOM)
LM337L	SOIC (8)	3.91 mm x 4.90 mm
	TO-92 (3)	4.30 mm x 4.30 mm

(1) For all available packages, see the orderable addendum at the end of the data sheet.

1.2-V to 25-V Adjustable Regulator

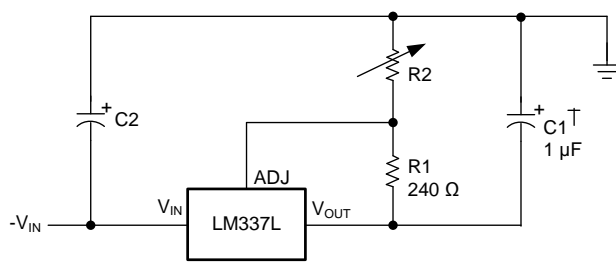

Copyright © 2016, Texas Instruments Incorporated

LM337L Available Packages

Pin 1. Output
2. Adjustment
3. Input

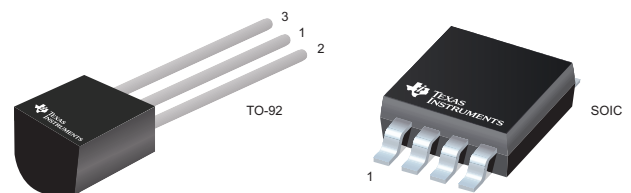

Table of Contents

1 Features	1	7.4 Device Functional Modes.....	6
2 Applications	1	8 Application and Implementation	8
3 Description	1	8.1 Application Information.....	8
4 Revision History	2	8.2 Typical Applications	8
5 Pin Configuration and Functions	3	9 Power Supply Recommendations	10
6 Specifications	3	10 Layout	10
6.1 Absolute Maximum Ratings	3	10.1 Layout Guidelines	10
6.2 ESD Ratings.....	3	10.2 Layout Example	10
6.3 Recommended Operating Conditions.....	3	11 Device and Documentation Support	11
6.4 Thermal Information	4	11.1 Documentation Support	11
6.5 Electrical Characteristics.....	4	11.2 Receiving Notification of Documentation Updates	11
6.6 Typical Characteristics	5	11.3 Community Resources.....	11
7 Detailed Description	6	11.4 Trademarks	11
7.1 Overview	6	11.5 Electrostatic Discharge Caution.....	11
7.2 Functional Block Diagram	6	11.6 Glossary	11
7.3 Feature Description.....	6	12 Mechanical, Packaging, and Orderable Information	11

4 Revision History

NOTE: Page numbers for previous revisions may differ from page numbers in the current version.

Changes from Revision D (May 2013) to Revision E	Page
• Added <i>Applications</i> section, <i>Device Information</i> table, <i>Pin Configuration and Functions</i> section, <i>ESD Ratings</i> table, <i>Recommended Operating Conditions</i> table, <i>Typical Characteristics</i> section, <i>Detailed Description</i> section, <i>Application and Implementation</i> section, <i>Power Supply Recommendations</i> section, <i>Layout</i> section, <i>Device and Documentation Support</i> section, and <i>Mechanical, Packaging, and Orderable Information</i> section	1
• Deleted DSBGA Package references throughout the data sheet	1
• Deleted soldering information rows from Absolute Maximum Ratings table	3
• Added <i>Thermal Information</i> table	4
• Changed R _{θJA} values for D (SOIC) package From: 180 To: 111.3 and for LP (TO-92) package From: 160 To: 156.9	4

Changes from Revision C (May 2013) to Revision D	Page
• Changed layout of National Semiconductor Data Sheet to TI format	1

5 Pin Configuration and Functions

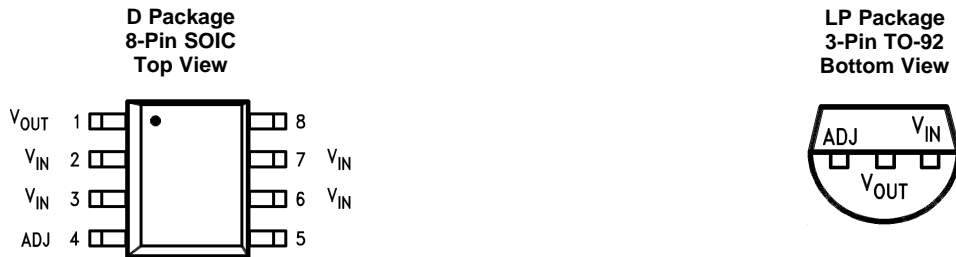

Pin Functions

NAME	PIN		I/O	DESCRIPTION
	TO-92	SOIC		
ADJ	1	4	—	Adjust pin
NC	—	5, 8	—	No connection
VIN	3	2, 3, 6, 7	Input	Input voltage pin for the regulator
VOUT	2	1	Output	Output voltage pin for the regulator

6 Specifications

6.1 Absolute Maximum Ratings

See ⁽¹⁾⁽²⁾

	MIN	MAX	UNIT
Input-output voltage differential		40	V
Power dissipation	Internally Limited		
Storage temperature, T_{stg}	-55	150	°C

- (1) Stresses beyond those listed under *Absolute Maximum Ratings* may cause permanent damage to the device. These are stress ratings only, which do not imply functional operation of the device at these or any other conditions beyond those indicated under *Recommended Operating Conditions*. Exposure to absolute-maximum-rated conditions for extended periods may affect device reliability.
- (2) If Military/Aerospace specified devices are required, please contact the Texas Instruments Sales Office/Distributors for availability and specifications.

6.2 ESD Ratings

$V_{(ESD)}$	Electrostatic discharge	Human-body model (HBM), per ANSI/ESDA/JEDEC JS-001 ⁽¹⁾⁽²⁾	VALUE	UNIT
			±1500	V

- (1) JEDEC document JEP155 states that 500-V HBM allows safe manufacturing with a standard ESD control process. Pins listed as ±1500 V may actually have higher performance.
- (2) Human-body model, 1.5k Ω in series with 100 pF.

6.3 Recommended Operating Conditions

over operating free-air temperature range (unless otherwise noted)

	MIN	MAX	UNIT
Operating junction temperature	-25	125	°C

6.4 Thermal Information

THERMAL METRIC ⁽¹⁾		LM337L		UNIT
		D (SOIC)	LP (TO-92)	
		8 PINS	3 PINS	
$R_{\theta JA}$	Junction-to-ambient thermal resistance	111.3	156.9	°C/W
$R_{\theta JC(top)}$	Junction-to-case (top) thermal resistance	56.1	80.2	°C/W
$R_{\theta JB}$	Junction-to-board thermal resistance	51.9	—	°C/W
ψ_{JT}	Junction-to-top characterization parameter	10.6	24.7	°C/W
ψ_{JB}	Junction-to-board characterization parameter	51.3	136.2	°C/W

(1) For more information about traditional and new thermal metrics, see the [Semiconductor and IC Package Thermal Metrics](#) application report.

6.5 Electrical Characteristics⁽¹⁾

PARAMETER	TEST CONDITIONS	MIN	TYP	MAX	UNIT
Line regulation ⁽²⁾	$T_A = 25^\circ\text{C}$, $3\text{ V} \leq V_{IN} - V_{OUT} \leq 40\text{ V}$		0.01	0.04	%/V
Load regulation ⁽²⁾	$T_A = 25^\circ\text{C}$, $5\text{ mA} \leq I_{OUT} \leq I_{MAX}$		0.1%	0.5%	
Thermal regulation	$T_A = 25^\circ\text{C}$, 10-ms Pulse		0.04	0.2	%/W
Adjustment pin current			50	100	μA
Adjustment pin current change	$5\text{ mA} \leq I_L \leq 100\text{ mA}$, $3\text{ V} \leq V_{IN} - V_{OUT} \leq 40\text{ V}$		0.2	5	μA
Reference voltage	$3\text{ V} \leq V_{IN} - V_{OUT} \leq 40\text{ V}$, $10\text{ mA} \leq I_{OUT} \leq 100\text{ mA}$, $P \leq 625\text{ mW}$	1.2	1.25	1.3	V
Line regulation ⁽²⁾	$3\text{ V} \leq V_{IN} - V_{OUT} \leq 40\text{ V}$		0.02	0.07	%/V
Load regulation ⁽²⁾	$5\text{ mA} \leq I_{OUT} \leq 100\text{ mA}$		0.3%	1.5%	
Temperature stability	$T_{MIN} \leq T_J \leq T_{MAX}$		0.65%		
Minimum load current	$ V_{IN} - V_{OUT} \leq 40\text{ V}$		3.5	5	mA
	$3\text{ V} \leq V_{IN} - V_{OUT} \leq 15\text{ V}$		2.2	3.5	mA
Current limit	$3\text{ V} \leq V_{IN} - V_{OUT} \leq 13\text{ V}$	100	200	320	mA
	$ V_{IN} - V_{OUT} = 40\text{ V}$	25	50	120	mA
RMS output noise, % of V_{OUT}	$T_A = 25^\circ\text{C}$, $10\text{ Hz} \leq f \leq 10\text{ kHz}$		0.003%		
Ripple rejection ratio	$V_{OUT} = -10\text{ V}$, $F = 120\text{ Hz}$, $C_{ADJ} = 0$		65		dB
	$C_{ADJ} = 10\ \mu\text{F}$	66	80		dB
Long-term stability	$T_A = 125^\circ\text{C}$		0.3%	1%	

- (1) Unless otherwise specified, these specifications apply $-25^\circ\text{C} \leq T_J \leq 125^\circ\text{C}$ for the LM337L; $|V_{IN} - V_{OUT}| = 5\text{ V}$ and $I_{OUT} = 40\text{ mA}$. Although power dissipation is internally limited, these specifications are applicable for power dissipations up to 625 mW. I_{MAX} is 100 mA.
- (2) Regulation is measured at constant junction temperature, using pulse testing with a low duty cycle. Changes in output voltage due to heating effects are covered under the specification for thermal regulation.

6.6 Typical Characteristics

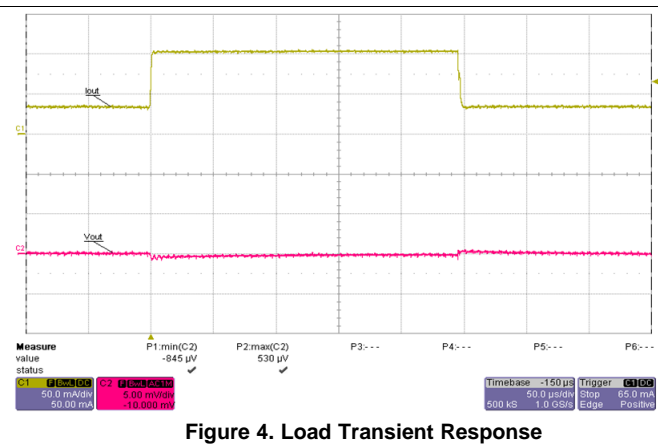
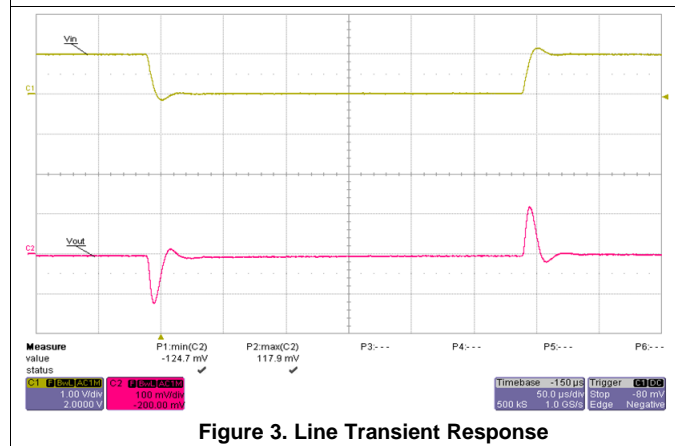
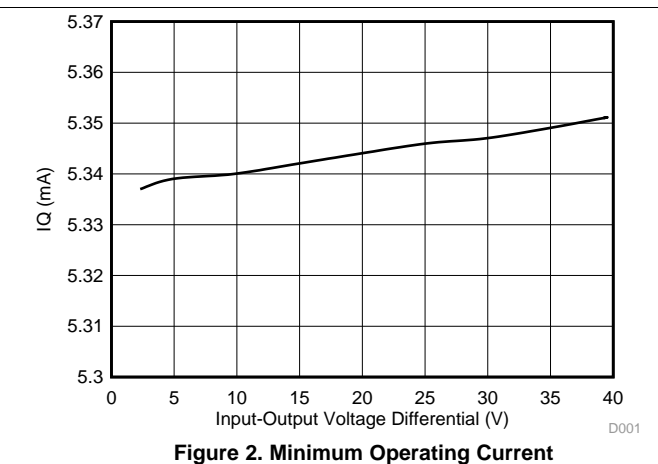
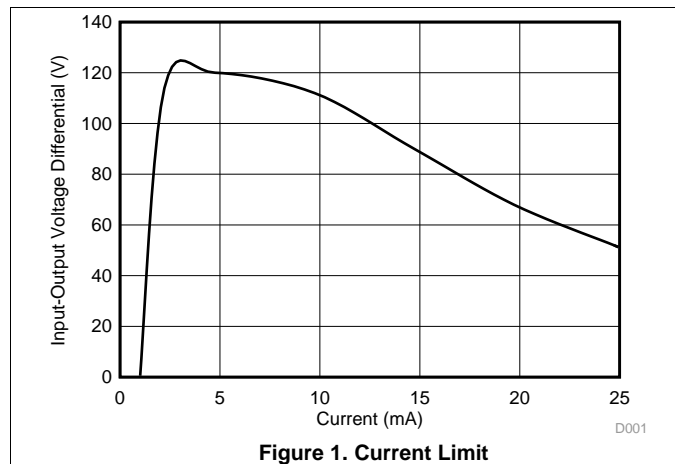

7 Detailed Description

7.1 Overview

The LM337L devices are adjustable 3-terminal negative-voltage regulators capable of supplying 100 mA over an output voltage range of -1.2 V to -37 V . They are exceptionally easy to use, requiring only two external resistors to set the output voltage and one output capacitor for frequency compensation. In addition, LM337L offers full overload protection. Included on the chip are current limit, thermal overload protection and safe area protection. All overload protection circuitry remains fully functional even if the adjustment terminal is disconnected. The LMx37 devices serve a wide variety of applications, including local on-card regulation, programmable output-voltage regulation, and precision current regulation.

7.2 Functional Block Diagram

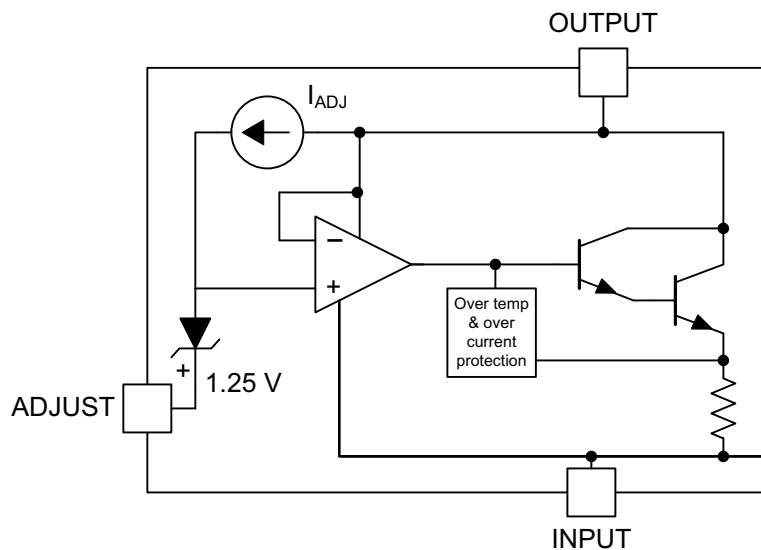

Copyright © 2016, Texas Instruments Incorporated

7.3 Feature Description

7.3.1 Output Voltage Adjustment

The Adjustment (ADJ) pin serves as a voltage adjustment reference for the output. The ADJ pin can be attached to a resistor divider circuit to adjust the output voltage level. The reference voltage V_{ADJ} will typically be 1.25 V higher than V_O .

7.4 Device Functional Modes

7.4.1 Protection Diodes

When external capacitors are used with any IC regulator, it is sometimes necessary to add protection diodes to prevent the capacitors from discharging through low current points into the regulator. Most 10- μF capacitors have low enough internal series resistance to deliver 20-A spikes when shorted. Although the surge is short, there is enough energy to damage parts of the IC. When an output capacitor is connected to a negative output regulator and the input is shorted, the output capacitor pulls current out of the output of the regulator. The current depends on the value of the capacitor, the output voltage of the regulator, and the rate at which V_{IN} is shorted to ground. The bypass capacitor on the adjustment terminal can discharge through a low current junction. Discharge occurs when either the input, or the output, is shorted. Figure 15 shows the placement of the protection diodes.

Device Functional Modes (continued)

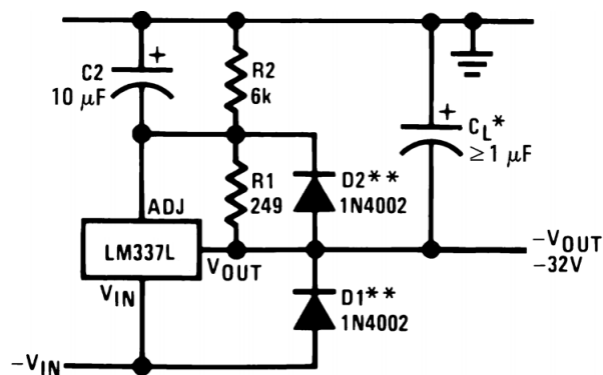

When C_L is larger than $20 \mu\text{F}$, D1 protects the LM337L in case the input supply is shorted.

When C_2 is larger than $10 \mu\text{F}$ and $-V_{OUT}$ is larger than -25V , D2 protects the LM337L in case the output is shorted.

Figure 5. Regulator With Protection Diodes

8 Application and Implementation

NOTE

Information in the following applications sections is not part of the TI component specification, and TI does not warrant its accuracy or completeness. TI's customers are responsible for determining suitability of components for their purposes. Customers should validate and test their design implementation to confirm system functionality.

8.1 Application Information

The LM337L is a negative output linear regulator with high accuracy and a wide temperature range. An output capacitor can be added to further improve transient response, and the ADJ pin can be bypassed to achieve very high ripple-rejection ratios. The device's functionality can be utilized in many different applications that require negative voltage supplies, such as bipolar amplifiers, operational amplifiers, and constant current regulators.

8.2 Typical Applications

8.2.1 1.2-V to 25-V Adjustable Regulator

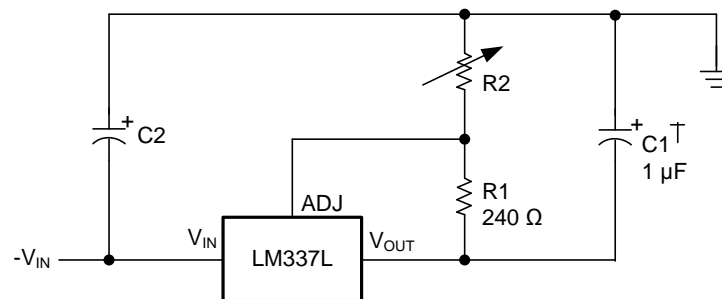

Copyright © 2016, Texas Instruments Incorporated

Full output current not available at high input-output voltages

†C1 = 1-μF solid tantalum or 10-μF aluminum electrolytic required for stability

*C2 = 1-μF solid tantalum is required only if regulator is more than 4" from power supply filter capacitor

Figure 6. 1.2-V to 25-V Adjustable Regulator Diagram

8.2.1.1 Design Requirements

The device component count is very minimal, employing two resistors as part of a voltage divider circuit and an output capacitor for load regulation. An input capacitor is needed if the device is more than 4 in. from the filter capacitors.

8.2.1.2 Detailed Design Procedure

The output voltage is set based on the selection of the two resistors (R1 and R2) as shown in [Equation 1](#).

$$-V_{\text{OUT}} = -1.25 \text{ V} \left(1 + \frac{R2}{240 \Omega} \right) \quad (1)$$

Typical Applications (continued)

8.2.1.3 Application Curve

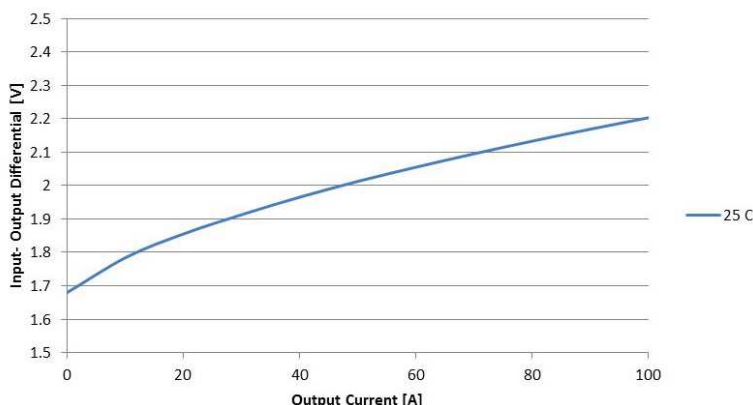
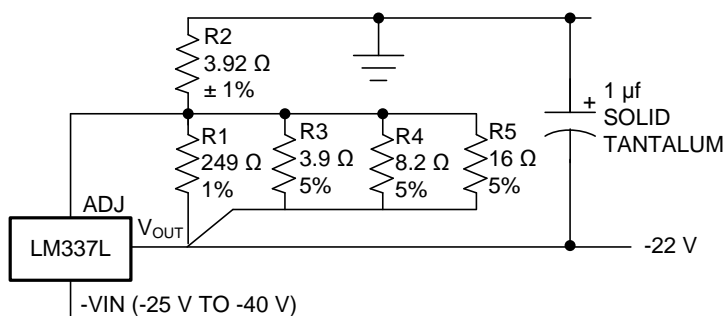

Figure 7. Dropout Voltage across Load Current at 25°C ($\Delta V_{out} < 100 \text{ mV}$)

8.2.2 Regulator With Trimmable Output Voltage



Copyright © 2016, Texas Instruments Incorporated

Figure 8. Regulator with Trimmable Output Voltage Diagram

8.2.2.1 Design Requirements

This design uses five resistors with two being used for a voltage divider circuit and the other three used for trimming the output voltage. The benefit is lower cost as compared to using a trim pot. An output capacitor is needed to improve load regulation.

8.2.2.2 Detailed Design Procedure

This design will trim the output voltage to within 1% of -22 V . The parallel combination of R1, R3, R4 and R5 serve as the bottom resistance and R2 as the top resistance in the voltage divider that sets the output voltage.

Trim Procedure:

- If V_{OUT} is -23.08 V or larger, do not use R3, otherwise leave it in.
- Then if V_{OUT} is -22.47 V or bigger, do not use R4, otherwise leave it in.
- Then if V_{OUT} is -22.16 V or bigger, do not use R5, otherwise leave it in.

This will trim the output to well within 1% of -22 V_{DC} , without any of the expense or trouble of a trim pot (see LB-46). This technique can be used at any output voltage level.

9 Power Supply Recommendations

The input supply to the LM337L must be kept at a voltage level such that its maximum input to output differential voltage rating is not exceeded. The minimum dropout voltage must also be met with extra headroom when possible to keep the LM337L in regulation. TI recommends an input capacitor, especially when the input pin is placed more than 4 in. away from the power-supply filter capacitor.

10 Layout

10.1 Layout Guidelines

Some layout guidelines must be followed to ensure proper regulation of the output voltage with minimum noise. Traces carrying the load current must be wide to reduce the amount of parasitic trace inductance and the feedback loop from VOUT to ADJ must be kept as short as possible. To improve PSRR, a bypass capacitor can be placed at the ADJ pin and must be placed as close as possible to the IC. In cases when VIN shorts to ground, an external diode must be placed from VIN to VOUT to divert the surge current into the output capacitor and protect the IC. Similarly, in cases when a large bypass capacitor is placed at the ADJ pin and VOUT shorts to ground, an external diode must be placed from VOUT to ADJ to provide a path for the bypass capacitor to discharge. These diodes must be placed close to the corresponding IC pins to increase their effectiveness.

10.2 Layout Example

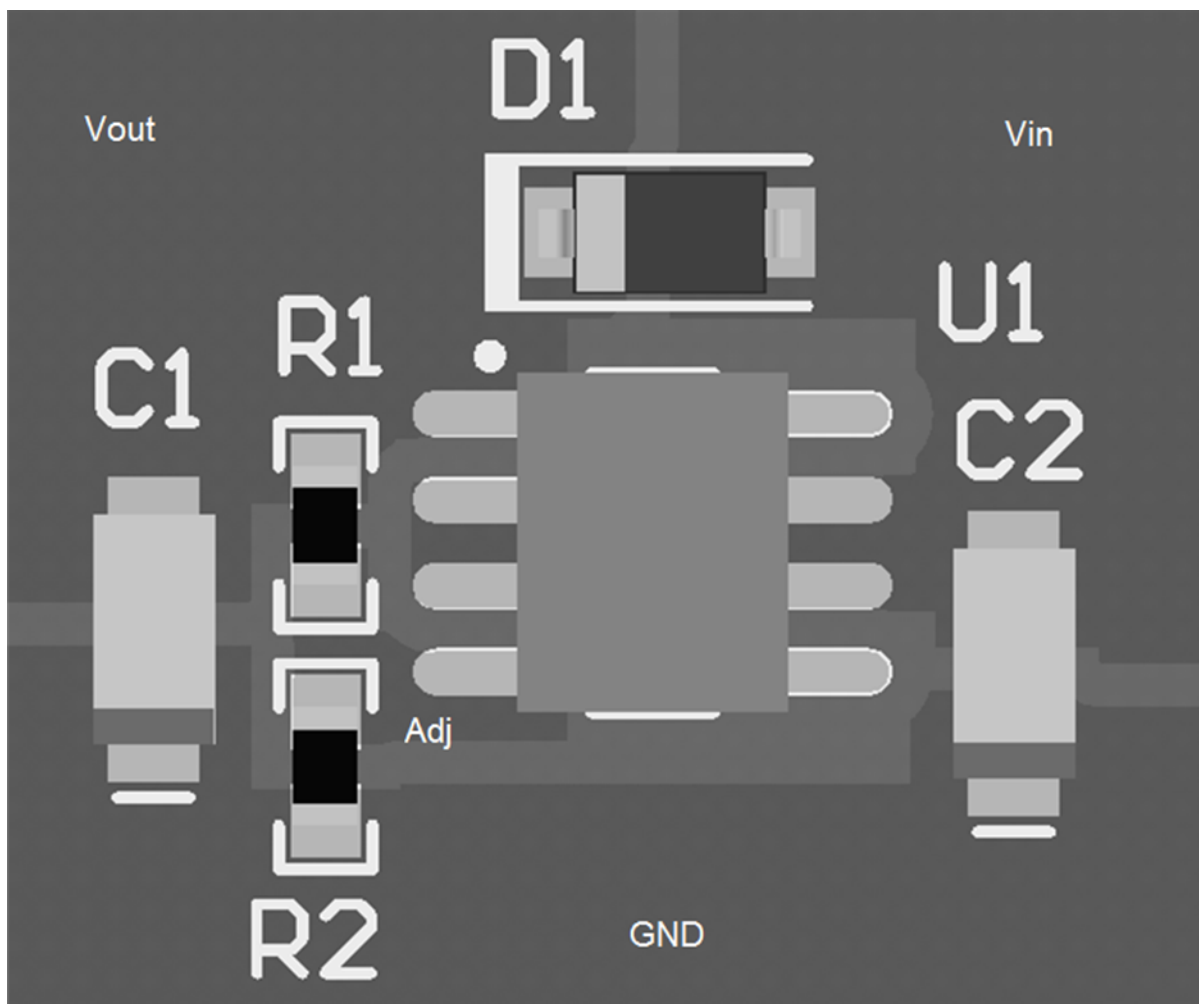

Figure 9. LM337L Layout Example

11 Device and Documentation Support

11.1 Documentation Support

11.1.1 Related Documentation

For related documentation see the following:

- [LM317L-N 3-Terminal Adjustable Regulator](#) (SNOSBW2)
- [LM117, LM317-N Wide Temperature Three-Pin Adjustable Regulator](#) (SNVS774)
- [LM317L-N 3-Terminal Adjustable Regulator](#) (SNVS775)

11.2 Receiving Notification of Documentation Updates

To receive notification of documentation updates, navigate to the device product folder on ti.com. In the upper right corner, click on *Alert me* to register and receive a weekly digest of any product information that has changed. For change details, review the revision history included in any revised document.

11.3 Community Resources

The following links connect to TI community resources. Linked contents are provided "AS IS" by the respective contributors. They do not constitute TI specifications and do not necessarily reflect TI's views; see TI's [Terms of Use](#).

TI E2E™ Online Community *TI's Engineer-to-Engineer (E2E) Community*. Created to foster collaboration among engineers. At e2e.ti.com, you can ask questions, share knowledge, explore ideas and help solve problems with fellow engineers.

Design Support *TI's Design Support* Quickly find helpful E2E forums along with design support tools and contact information for technical support.

11.4 Trademarks

E2E is a trademark of Texas Instruments.
All other trademarks are the property of their respective owners.

11.5 Electrostatic Discharge Caution



This integrated circuit can be damaged by ESD. Texas Instruments recommends that all integrated circuits be handled with appropriate precautions. Failure to observe proper handling and installation procedures can cause damage.

ESD damage can range from subtle performance degradation to complete device failure. Precision integrated circuits may be more susceptible to damage because very small parametric changes could cause the device not to meet its published specifications.

11.6 Glossary

[SLYZ022](#) — *TI Glossary*.

This glossary lists and explains terms, acronyms, and definitions.

12 Mechanical, Packaging, and Orderable Information

The following pages include mechanical, packaging, and orderable information. This information is the most current data available for the designated devices. This data is subject to change without notice and revision of this document. For browser-based versions of this data sheet, refer to the left-hand navigation.

PACKAGING INFORMATION

Orderable Device	Status (1)	Package Type	Package Drawing	Pins	Package Qty	Eco Plan (2)	Lead/Ball Finish (6)	MSL Peak Temp (3)	Op Temp (°C)	Device Marking (4/5)	Samples
LM337LM	NRND	SOIC	D	8	95	TBD	Call TI	Call TI	-25 to 100	LM337 LM	
LM337LM/NOPB	ACTIVE	SOIC	D	8	95	Green (RoHS & no Sb/Br)	CU SN	Level-1-260C-UNLIM	-25 to 100	LM337 LM	Samples
LM337LMX	NRND	SOIC	D	8	2500	TBD	Call TI	Call TI	-25 to 100	LM337 LM	
LM337LMX/NOPB	ACTIVE	SOIC	D	8	2500	Green (RoHS & no Sb/Br)	CU SN	Level-1-260C-UNLIM	-25 to 100	LM337 LM	Samples
LM337LZ/LFT3	ACTIVE	TO-92	LP	3	2000	Green (RoHS & no Sb/Br)	CU SN	N / A for Pkg Type		LM337 LZ	Samples
LM337LZ/NOPB	ACTIVE	TO-92	LP	3	1800	Green (RoHS & no Sb/Br)	CU SN	N / A for Pkg Type	-25 to 100	LM337 LZ	Samples

(1) The marketing status values are defined as follows:

ACTIVE: Product device recommended for new designs.

LIFEBUY: TI has announced that the device will be discontinued, and a lifetime-buy period is in effect.

NRND: Not recommended for new designs. Device is in production to support existing customers, but TI does not recommend using this part in a new design.

PREVIEW: Device has been announced but is not in production. Samples may or may not be available.

OBSELETE: TI has discontinued the production of the device.

(2) Eco Plan - The planned eco-friendly classification: Pb-Free (RoHS), Pb-Free (RoHS Exempt), or Green (RoHS & no Sb/Br) - please check <http://www.ti.com/productcontent> for the latest availability information and additional product content details.

TBD: The Pb-Free/Green conversion plan has not been defined.

Pb-Free (RoHS): TI's terms "Lead-Free" or "Pb-Free" mean semiconductor products that are compatible with the current RoHS requirements for all 6 substances, including the requirement that lead not exceed 0.1% by weight in homogeneous materials. Where designed to be soldered at high temperatures, TI Pb-Free products are suitable for use in specified lead-free processes.

Pb-Free (RoHS Exempt): This component has a RoHS exemption for either 1) lead-based flip-chip solder bumps used between the die and package, or 2) lead-based die adhesive used between the die and leadframe. The component is otherwise considered Pb-Free (RoHS compatible) as defined above.

Green (RoHS & no Sb/Br): TI defines "Green" to mean Pb-Free (RoHS compatible), and free of Bromine (Br) and Antimony (Sb) based flame retardants (Br or Sb do not exceed 0.1% by weight in homogeneous material)

(3) MSL, Peak Temp. - The Moisture Sensitivity Level rating according to the JEDEC industry standard classifications, and peak solder temperature.

(4) There may be additional marking, which relates to the logo, the lot trace code information, or the environmental category on the device.

(5) Multiple Device Markings will be inside parentheses. Only one Device Marking contained in parentheses and separated by a "~" will appear on a device. If a line is indented then it is a continuation of the previous line and the two combined represent the entire Device Marking for that device.

⁽⁶⁾ Lead/Ball Finish - Orderable Devices may have multiple material finish options. Finish options are separated by a vertical ruled line. Lead/Ball Finish values may wrap to two lines if the finish value exceeds the maximum column width.

Important Information and Disclaimer: The information provided on this page represents TI's knowledge and belief as of the date that it is provided. TI bases its knowledge and belief on information provided by third parties, and makes no representation or warranty as to the accuracy of such information. Efforts are underway to better integrate information from third parties. TI has taken and continues to take reasonable steps to provide representative and accurate information but may not have conducted destructive testing or chemical analysis on incoming materials and chemicals. TI and TI suppliers consider certain information to be proprietary, and thus CAS numbers and other limited information may not be available for release.

In no event shall TI's liability arising out of such information exceed the total purchase price of the TI part(s) at issue in this document sold by TI to Customer on an annual basis.

TAPE AND REEL INFORMATION

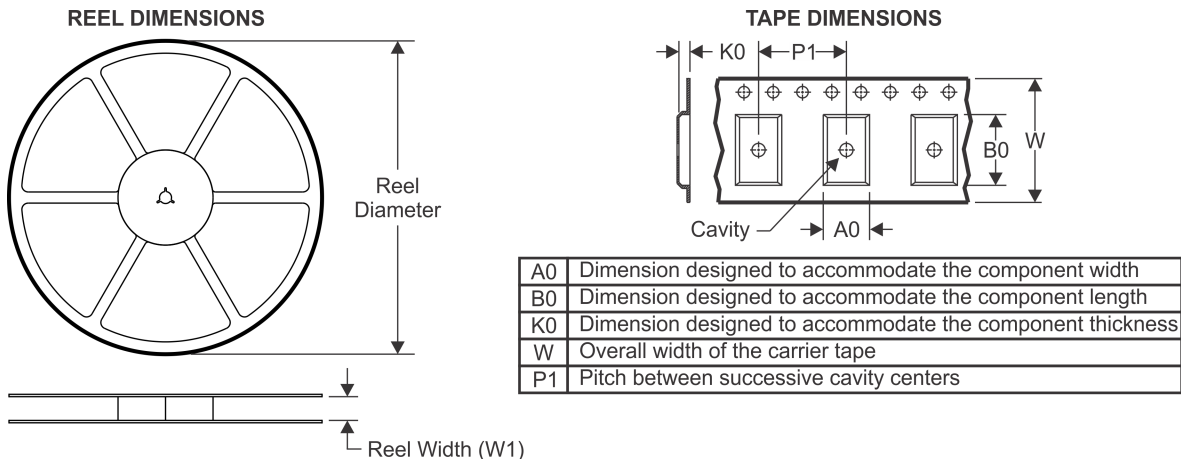

QUADRANT ASSIGNMENTS FOR PIN 1 ORIENTATION IN TAPE



*All dimensions are nominal

Device	Package Type	Package Drawing	Pins	SPQ	Reel Diameter (mm)	Reel Width W1 (mm)	A0 (mm)	B0 (mm)	K0 (mm)	P1 (mm)	W (mm)	Pin1 Quadrant
LM337LMX	SOIC	D	8	2500	330.0	12.4	6.5	5.4	2.0	8.0	12.0	Q1
LM337LMX/NOPB	SOIC	D	8	2500	330.0	12.4	6.5	5.4	2.0	8.0	12.0	Q1

TAPE AND REEL BOX DIMENSIONS



*All dimensions are nominal

Device	Package Type	Package Drawing	Pins	SPQ	Length (mm)	Width (mm)	Height (mm)
LM337LMX	SOIC	D	8	2500	367.0	367.0	35.0
LM337LMX/NOPB	SOIC	D	8	2500	367.0	367.0	35.0



D0008A

PACKAGE OUTLINE

SOIC - 1.75 mm max height

SMALL OUTLINE INTEGRATED CIRCUIT



4214825/C 02/2019

NOTES:

- Linear dimensions are in inches [millimeters]. Dimensions in parenthesis are for reference only. Controlling dimensions are in inches. Dimensioning and tolerancing per ASME Y14.5M.
- This drawing is subject to change without notice.
- This dimension does not include mold flash, protrusions, or gate burrs. Mold flash, protrusions, or gate burrs shall not exceed .006 [0.15] per side.
- This dimension does not include interlead flash.
- Reference JEDEC registration MS-012, variation AA.

EXAMPLE BOARD LAYOUT

D0008A

SOIC - 1.75 mm max height

SMALL OUTLINE INTEGRATED CIRCUIT



LAND PATTERN EXAMPLE
EXPOSED METAL SHOWN
SCALE:8X



SOLDER MASK DETAILS

4214825/C 02/2019

NOTES: (continued)

6. Publication IPC-7351 may have alternate designs.

7. Solder mask tolerances between and around signal pads can vary based on board fabrication site.

EXAMPLE STENCIL DESIGN

D0008A

SOIC - 1.75 mm max height

SMALL OUTLINE INTEGRATED CIRCUIT



SOLDER PASTE EXAMPLE
BASED ON .005 INCH [0.125 MM] THICK STENCIL
SCALE:8X

4214825/C 02/2019

NOTES: (continued)

8. Laser cutting apertures with trapezoidal walls and rounded corners may offer better paste release. IPC-7525 may have alternate design recommendations.
9. Board assembly site may have different recommendations for stencil design.

GENERIC PACKAGE VIEW

LP 3

TO-92 - 5.34 mm max height

TRANSISTOR OUTLINE



Images above are just a representation of the package family, actual package may vary.
Refer to the product data sheet for package details.

4040001-2/F

LP0003A



PACKAGE OUTLINE

TO-92 - 5.34 mm max height

TO-92



4215214/B 04/2017

NOTES:

1. All linear dimensions are in millimeters. Any dimensions in parenthesis are for reference only. Dimensioning and tolerancing per ASME Y14.5M.
2. This drawing is subject to change without notice.
3. Lead dimensions are not controlled within this area.
4. Reference JEDEC TO-226, variation AA.
5. Shipping method:
 - a. Straight lead option available in bulk pack only.
 - b. Formed lead option available in tape and reel or ammo pack.
 - c. Specific products can be offered in limited combinations of shipping medium and lead options.
 - d. Consult product folder for more information on available options.

EXAMPLE BOARD LAYOUT

LP0003A

TO-92 - 5.34 mm max height

TO-92

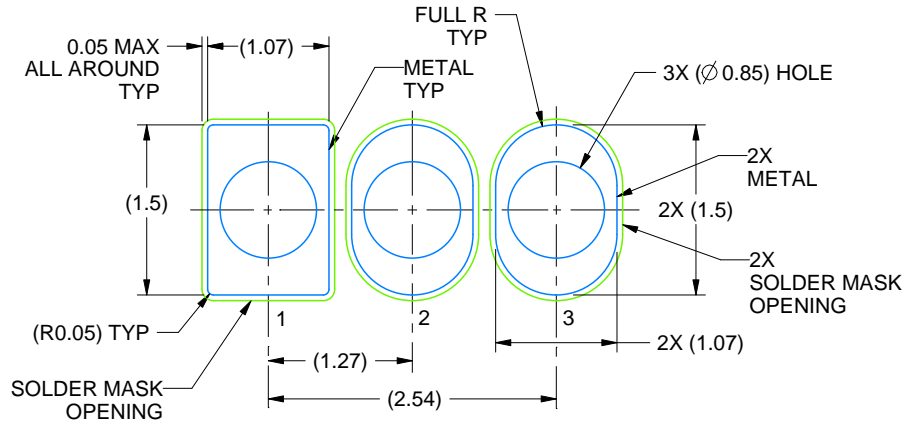

LAND PATTERN EXAMPLE
STRAIGHT LEAD OPTION
NON-SOLDER MASK DEFINED
SCALE:15X



LAND PATTERN EXAMPLE
FORMED LEAD OPTION
NON-SOLDER MASK DEFINED
SCALE:15X

4215214/B 04/2017

TAPE SPECIFICATIONS

LP0003A

TO-92 - 5.34 mm max height

TO-92

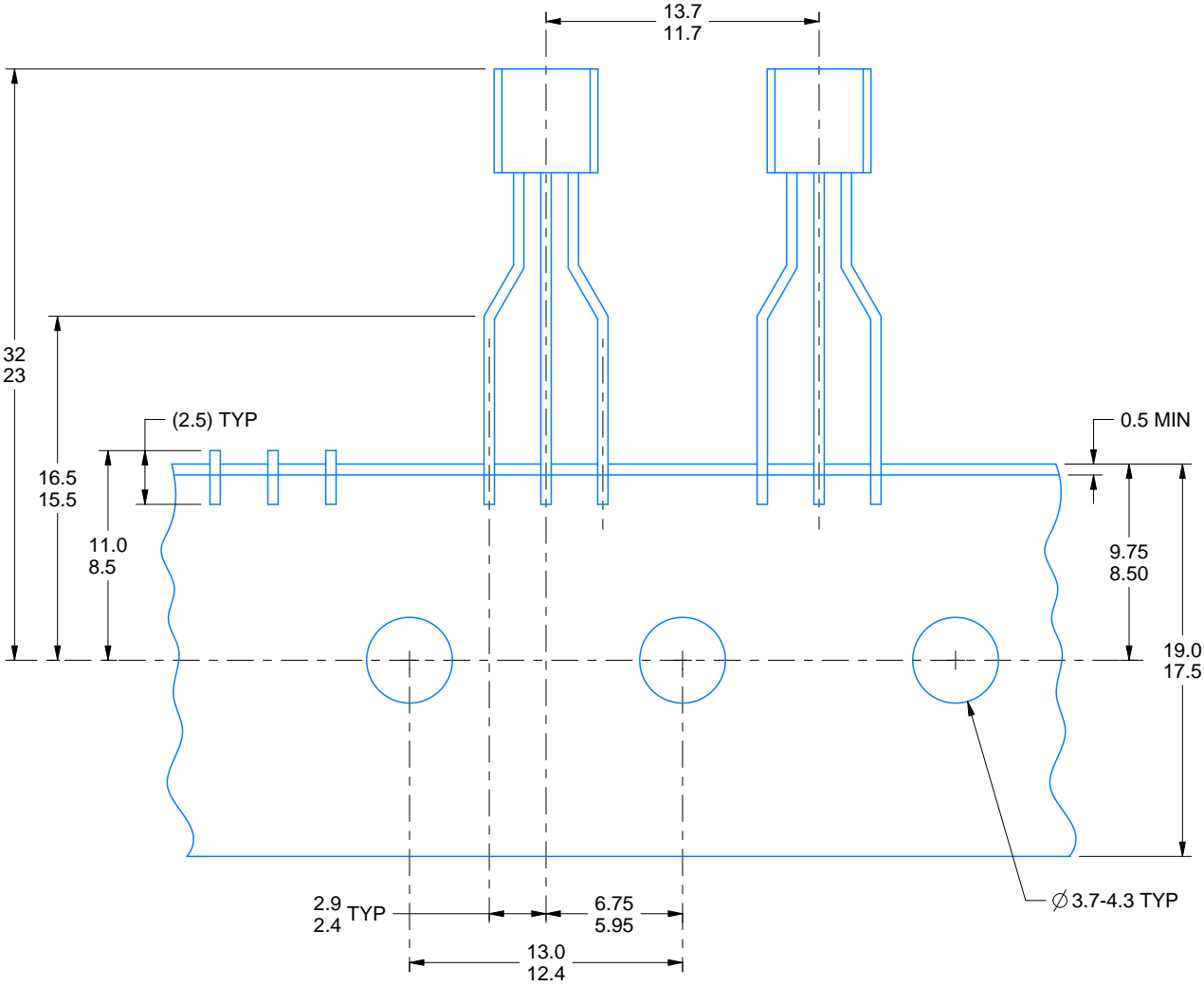

FOR FORMED LEAD OPTION PACKAGE

4215214/B 04/2017

IMPORTANT NOTICE AND DISCLAIMER

TI PROVIDES TECHNICAL AND RELIABILITY DATA (INCLUDING DATASHEETS), DESIGN RESOURCES (INCLUDING REFERENCE DESIGNS), APPLICATION OR OTHER DESIGN ADVICE, WEB TOOLS, SAFETY INFORMATION, AND OTHER RESOURCES "AS IS" AND WITH ALL FAULTS, AND DISCLAIMS ALL WARRANTIES, EXPRESS AND IMPLIED, INCLUDING WITHOUT LIMITATION ANY IMPLIED WARRANTIES OF MERCHANTABILITY, FITNESS FOR A PARTICULAR PURPOSE OR NON-INFRINGEMENT OF THIRD PARTY INTELLECTUAL PROPERTY RIGHTS.

These resources are intended for skilled developers designing with TI products. You are solely responsible for (1) selecting the appropriate TI products for your application, (2) designing, validating and testing your application, and (3) ensuring your application meets applicable standards, and any other safety, security, or other requirements. These resources are subject to change without notice. TI grants you permission to use these resources only for development of an application that uses the TI products described in the resource. Other reproduction and display of these resources is prohibited. No license is granted to any other TI intellectual property right or to any third party intellectual property right. TI disclaims responsibility for, and you will fully indemnify TI and its representatives against, any claims, damages, costs, losses, and liabilities arising out of your use of these resources.

TI's products are provided subject to TI's Terms of Sale (www.ti.com/legal/termsofsale.html) or other applicable terms available either on ti.com or provided in conjunction with such TI products. TI's provision of these resources does not expand or otherwise alter TI's applicable warranties or warranty disclaimers for TI products.

Mailing Address: Texas Instruments, Post Office Box 655303, Dallas, Texas 75265
Copyright © 2019, Texas Instruments Incorporated





Looking for pricing, stock, or lifecycle information?

Click below to explore more details on WIN SOURCE:

 [View LM337LZ/NOPB on WIN SOURCE](#)

 [Texas Instruments](#) Information

Optimize Your Supply Chain with WIN SOURCE Solutions

-  Global Sourcing Solution
-  Obsolete Management
-  Cost Control Management
-  Shortage Management
-  Alternative Solution
-  Excess Inventory Management