



**THE DATASHEET OF
LM3480IM3X-3.3/NOPB**





LM3480 100-mA, SOT-23, Quasi Low-Dropout Linear Voltage Regulator

1 Features

- Input Voltage Range: up to 30 V
- 3.3-V, 5-V, 12-V, and 15-V Versions Available
- Packaged in the Tiny 3-Lead SOT-23 Package
- 30-V Maximum Input for Operation
- 1.2-V Ensured Maximum Dropout Over Full Load and Temperature Ranges
- 100-mA Ensured Minimum Load Current
- $\pm 5\%$ Ensured Output Voltage Tolerance Over Full Load and Temperature Ranges
- -40 to $+125^\circ\text{C}$ Junction Temperature Range for Operation

2 Applications

- Tiny Alternative to LM78Lxx Series and Similar Devices
- Tiny 5-V $\pm 5\%$ to 3.3-V, 100-mA Converter
- Post Regulator for Switching DC/DC Converter
- Bias Supply for Analog Circuits

3 Description

The LM3480 is an integrated linear voltage regulator. It features operation from an input as high as 30 V and an ensured maximum dropout of 1.2 V at the full 100-mA load. Standard packaging for the LM3480 is the 3-lead SOT-23 package.

The 5-V, 12-V, and 15-V members of the LM3480 series are intended as tiny alternatives to industry standard LM78Lxx series and similar devices. The 1.2-V quasi-low dropout of LM3480 series devices makes them a nice fit in many applications where the 2-V to 2.5-V dropout of LM78Lxx series devices precludes their (LM78Lxx series devices) use.

The LM3480 series also features a 3.3-V member. The SOT-23 packaging and quasi-low dropout features of the LM3480 series converge in this device to provide a very nice, very tiny, 3.3-V, 100-mA bias supply that regulates directly off the system 5-V $\pm 5\%$ power supply.

Device Information⁽¹⁾

PART NUMBER	PACKAGE	BODY SIZE (NOM)
LM3480	SOT-23 (3)	2.92 mm x 1.30 mm

(1) For all available packages, see the orderable addendum at the end of the data sheet.

Typical Application Circuit

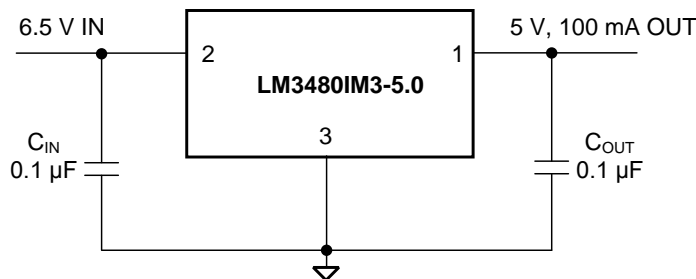

Table of Contents

1 Features	1	7.3 Feature Description.....	10
2 Applications	1	7.4 Device Functional Modes.....	10
3 Description	1	8 Application and Implementation	11
4 Revision History	2	8.1 Application Information.....	11
5 Pin Configuration and Functions	3	8.2 Typical Application	11
6 Specifications	4	9 Power Supply Recommendations	13
6.1 Absolute Maximum Ratings	4	10 Layout	13
6.2 ESD Ratings.....	4	10.1 Layout Guidelines	13
6.3 Recommended Operating Conditions.....	4	10.2 Layout Example	13
6.4 Thermal Information	4	11 Device and Documentation Support	14
6.5 Electrical Characteristics: LM3480-3.3, LM3480-5 ...	5	11.1 Community Resources.....	14
6.6 Electrical Characteristics: LM3480-12, LM3480-15 ..	6	11.2 Trademarks	14
6.7 Typical Characteristics	7	11.3 Electrostatic Discharge Caution.....	14
7 Detailed Description	10	11.4 Glossary	14
7.1 Overview	10	12 Mechanical, Packaging, and Orderable Information	14
7.2 Functional Block Diagram	10		

4 Revision History

NOTE: Page numbers for previous revisions may differ from page numbers in the current version.

Changes from Revision G (February 2015) to Revision H	Page
• Replaced <i>Functional Block Diagram</i>	10
• Changed text of <i>External Capacitors</i> subsection	11
• Changed text of <i>Output Capacitor</i> subsection	11

Changes from Revision F (December 2014) to Revision G	Page
• Changed pin numbers indicated in <i>Typical Application</i> drawing; fix typos.....	1
• Deleted soldering specs - found in POA	4
• Changed <i>Handling Ratings</i> to <i>ESD Ratings</i> format	4

Changes from Revision E (March 2013) to Revision F	Page
• Added <i>Pin Configuration and Functions</i> section, <i>Handling Rating</i> table, <i>Feature Description</i> section, <i>Device Functional Modes</i> , <i>Application and Implementation</i> section, <i>Power Supply Recommendations</i> section, <i>Layout</i> section, <i>Device and Documentation Support</i> section, and <i>Mechanical, Packaging, and Orderable Information</i> section; add updated <i>Thermal Information</i>	1

Changes from Revision D (March 2013) to Revision E	Page
• Changed layout of National Data Sheet to TI format	9

5 Pin Configuration and Functions

**DBZ Package
3-Pin SOT-23
Top View**

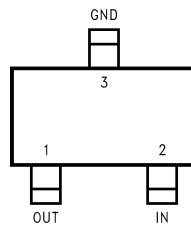

Pin Functions

PIN		I/O	DESCRIPTION
NAME	NO.		
OUT	1	O	Output voltage
IN	2	I	Input voltage supply
GND	3	—	Common ground

6 Specifications

6.1 Absolute Maximum Ratings⁽¹⁾⁽²⁾

	MIN	MAX	UNIT
Input voltage (IN to GND)	–0.3	35	V
Power dissipation ⁽³⁾		Internally Limited	
Junction temperature ⁽³⁾	–40	150	°C
Storage temperature, T _{stg}	–65	150	°C

- (1) *Absolute Maximum Ratings* are limits beyond which damage to the device may occur. *Recommended Operating Conditions* are conditions under which operation of the device is ensured. Recommended operating ratings do not imply ensured performance limits. For ensured performance limits and associated test conditions, see the [Electrical Characteristics: LM3480-3.3, LM3480-5](#).
- (2) If Military- or Aerospace-specified devices are required, please contact the TI Sales Office/Distributors for availability and specifications.
- (3) The Absolute Maximum power dissipation depends on the ambient temperature and can be calculated using $P = (T_J - T_A) / R_{\theta JA}$ where T_J is the junction temperature, T_A is the ambient temperature, and $R_{\theta JA}$ is the junction-to-ambient thermal resistance. The 370-mW rating results from substituting the Absolute Maximum junction temperature, 150°C for T_J , 50°C for T_A , and 269.6°C/W for $R_{\theta JA}$. More power can be safely dissipated at lower ambient temperatures. Less power can be safely dissipated at higher ambient temperatures. The Absolute Maximum power dissipation can be increased by 3.7 mW for each °C below 50°C ambient. It must be derated by 3.7 mW for each °C above 50°C ambient. Heat sinking enables the safe dissipation of more power. The LM3480 actively limits its junction temperature to about 150°C.

6.2 ESD Ratings

		VALUE	UNIT
V _(ESD)	Electrostatic discharge	Human-body model (HBM), per ANSI/ESDA/JEDEC JS-001 ⁽¹⁾	±2000
		Charged-device model (CDM), per JEDEC specification JESD22-C101 ⁽²⁾	±500

- (1) JEDEC document JEP155 states that 500-V HBM allows safe manufacturing with a standard ESD control process.
- (2) JEDEC document JEP157 states that 250-V CDM allows safe manufacturing with a standard ESD control process.

6.3 Recommended Operating Conditions

over operating free-air temperature range (unless otherwise noted)⁽¹⁾

	MIN	MAX	UNIT
Maximum input voltage (IN to GND)	0	30	V
Junction temperature (T _J)	–40	125	°C

- (1) *Absolute Maximum Ratings* are limits beyond which damage to the device may occur. *Recommended Operating Conditions* are conditions under which operation of the device is ensured. Recommended operating ratings do not imply ensured performance limits. For ensured performance limits and associated test conditions, see the [Electrical Characteristics: LM3480-3.3, LM3480-5](#).

6.4 Thermal Information

THERMAL METRIC ⁽¹⁾		LM3480	UNIT
		SOT-23 (DBZ)	
		3 PINS	
R _{θJA}	Junction-to-ambient thermal resistance	269.6	°C/W
R _{θJC(top)}	Junction-to-case (top) thermal resistance	141.1	
R _{θJB}	Junction-to-board thermal resistance	63.1	
ψ _{JT}	Junction-to-top characterization parameter	24.2	
ψ _{JB}	Junction-to-board characterization parameter	62.1	

- (1) For more information about traditional and new thermal metrics, see the *IC Package Thermal Metrics* application report, [SPRA953](#).

6.5 Electrical Characteristics: LM3480-3.3, LM3480-5

Typical and other limits apply for $T_A = T_J = 25^\circ\text{C}$, unless otherwise specified. Nominal output voltage (V_{NOM}) = 3.3 V or 5 V. ⁽¹⁾⁽²⁾⁽³⁾

PARAMETER	TEST CONDITIONS	$V_{\text{NOM}} = 3.3 \text{ V}$			$V_{\text{NOM}} = 5 \text{ V}$			UNIT
		MIN	TYP	MAX	MIN	TYP	MAX	
V_{OUT} Output voltage	$V_{\text{IN}} = V_{\text{NOM}} + 1.5 \text{ V}$ $1 \text{ mA} \leq I_{\text{OUT}} \leq 100 \text{ mA}$	3.17	3.3	3.43	4.8	5	5.2	V
	$V_{\text{IN}} = V_{\text{NOM}} + 1.5 \text{ V}$ $1 \text{ mA} \leq I_{\text{OUT}} \leq 100 \text{ mA}$ $-40^\circ\text{C} \leq T_J \leq 125^\circ\text{C}$	3.14		3.46	4.75		5.25	
ΔV_{OUT} Line regulation	$V_{\text{NOM}} + 1.5 \text{ V} \leq V_{\text{IN}} \leq 30 \text{ V}$ $I_{\text{OUT}} = 1 \text{ mA}$		10			12		mV
	$V_{\text{NOM}} + 1.5 \text{ V} \leq V_{\text{IN}} \leq 30 \text{ V}$ $I_{\text{OUT}} = 1 \text{ mA}$ $-40^\circ\text{C} \leq T_J \leq 125^\circ\text{C}$			25			25	
ΔV_{OUT} Load regulation	$V_{\text{IN}} = V_{\text{NOM}} + 1.5 \text{ V}$ $10 \text{ mA} \leq I_{\text{OUT}} \leq 100 \text{ mA}$		20			20		mV
	$V_{\text{IN}} = V_{\text{NOM}} + 1.5 \text{ V}$ $10 \text{ mA} \leq I_{\text{OUT}} \leq 100 \text{ m}$ $-40^\circ\text{C} \leq T_J \leq 125^\circ\text{C}$			40			40	
I_{GND} Ground pin current	$V_{\text{NOM}} + 1.5 \text{ V} \leq V_{\text{IN}} \leq 30 \text{ V}$ No Load		2			2		mA
	$V_{\text{NOM}} + 1.5 \text{ V} \leq V_{\text{IN}} \leq 30 \text{ V}$ No Load, $-40^\circ\text{C} \leq T_J \leq 125^\circ\text{C}$			4			4	
$V_{\text{IN}} - V_{\text{OUT}}$ Dropout voltage	$I_{\text{OUT}} = 10 \text{ mA}$		0.7	0.9		0.7	0.9	V
	$I_{\text{OUT}} = 10 \text{ mA}$ $-40^\circ\text{C} \leq T_J \leq 125^\circ\text{C}$			1			1	
	$I_{\text{OUT}} = 100 \text{ mA}$		0.9	1.1		0.9	1.1	V
	$I_{\text{OUT}} = 100 \text{ mA}$ $-40^\circ\text{C} \leq T_J \leq 125^\circ\text{C}$			1.2			1.2	
e_n Output noise voltage	$V_{\text{IN}} = 10 \text{ V}$ Bandwidth: 10 Hz to 100 kHz		100			150		μV_{rms}

- (1) A typical is the center of characterization data taken with $T_A = T_J = 25^\circ\text{C}$. Typical values are not ensured.
- (2) All limits are ensured. All electrical characteristics having room-temperature limits are tested during production with $T_A = T_J = 25^\circ\text{C}$. All hot and cold limits are ensured by correlating the electrical characteristics to process and temperature variations and applying statistical process control.
- (3) All voltages except dropout are with respect to the voltage at the GND pin.

6.6 Electrical Characteristics: LM3480-12, LM3480-15

Typical and other limits apply for $T_A = T_J = 25^\circ\text{C}$, unless otherwise specified. Nominal output voltage (V_{NOM}) = 12 V or 15 V.⁽¹⁾⁽²⁾⁽³⁾

PARAMETER	TEST CONDITIONS	$V_{\text{NOM}} = 12\text{ V}$			$V_{\text{NOM}} = 15\text{ V}$			UNIT
		MIN	TYP	MAX	MIN	TYP	MAX	
V_{OUT} Output voltage	$V_{\text{IN}} = V_{\text{NOM}} + 1.5\text{ V}$ $1\text{ mA} \leq I_{\text{OUT}} \leq 100\text{ mA}$	11.52	12	12.48	14.4	15	15.6	V
	$V_{\text{IN}} = V_{\text{NOM}} + 1.5\text{ V}$ $1\text{ mA} \leq I_{\text{OUT}} \leq 100\text{ mA}$ $-40^\circ\text{C} \leq T_J \leq 125^\circ\text{C}$	11.4		12.6	14.25		15.75	
ΔV_{OUT} Line regulation	$V_{\text{NOM}} + 1.5\text{ V} \leq V_{\text{IN}} \leq 30\text{ V}$ $I_{\text{OUT}} = 1\text{ mA}$		14			16		mV
	$V_{\text{NOM}} + 1.5\text{ V} \leq V_{\text{IN}} \leq 30\text{ V}$ $I_{\text{OUT}} = 1\text{ mA}$ $-40^\circ\text{C} \leq T_J \leq 125^\circ\text{C}$			40			40	
ΔV_{OUT} Load regulation	$V_{\text{IN}} = V_{\text{NOM}} + 1.5\text{ V}$ $10\text{ mA} \leq I_{\text{OUT}} \leq 100\text{ mA}$		36			45		mV
	$V_{\text{IN}} = V_{\text{NOM}} + 1.5\text{ V}$ $10\text{ mA} \leq I_{\text{OUT}} \leq 100\text{ mA}$ $-40^\circ\text{C} \leq T_J \leq 125^\circ\text{C}$			60			75	
I_{GND} Ground pin current	$V_{\text{NOM}} + 1.5\text{ V} \leq V_{\text{IN}} \leq 30\text{ V}$ No Load		2			2		mA
	$V_{\text{NOM}} + 1.5\text{ V} \leq V_{\text{IN}} \leq 30\text{ V}$ No Load, $-40^\circ\text{C} \leq T_J \leq 125^\circ\text{C}$			4			4	
$V_{\text{IN}} - V_{\text{OUT}}$ Dropout voltage	$I_{\text{OUT}} = 10\text{ mA}$		0.7	0.9		0.7	0.9	V
	$I_{\text{OUT}} = 10\text{ mA}$, $-40^\circ\text{C} \leq T_J \leq 125^\circ\text{C}$			1			1	
	$I_{\text{OUT}} = 100\text{ mA}$		0.9	1.1		0.9	1.1	V
	$I_{\text{OUT}} = 100\text{ mA}$, $-40^\circ\text{C} \leq T_J \leq 125^\circ\text{C}$			1.2			1.2	
e_n Output noise voltage	$V_{\text{IN}} = 10\text{ V}$ Bandwidth: 10 Hz to 100 kHz		360			450		μV_{rms}

- (1) A typical is the center of characterization data taken with $T_A = T_J = 25^\circ\text{C}$. Typical values are not ensured.
- (2) All limits are ensured. All electrical characteristics having room-temperature limits are tested during production with $T_A = T_J = 25^\circ\text{C}$. All hot and cold limits are ensured by correlating the electrical characteristics to process and temperature variations and applying statistical process control.
- (3) All voltages except dropout are with respect to the voltage at the GND pin.

6.7 Typical Characteristics

Unless indicated otherwise, $V_{IN} = V_{NOM} + 1.5\text{ V}$, $C_{IN} = 0.1\ \mu\text{F}$, $C_{OUT} = 0.1\ \mu\text{F}$, and $T_A = 25^\circ\text{C}$.

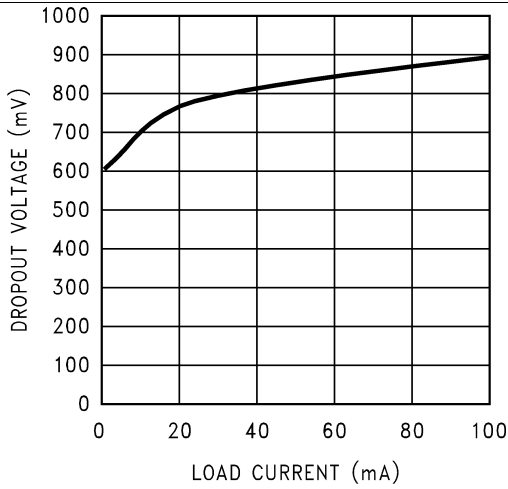

Figure 1. Dropout Voltage vs Load Current

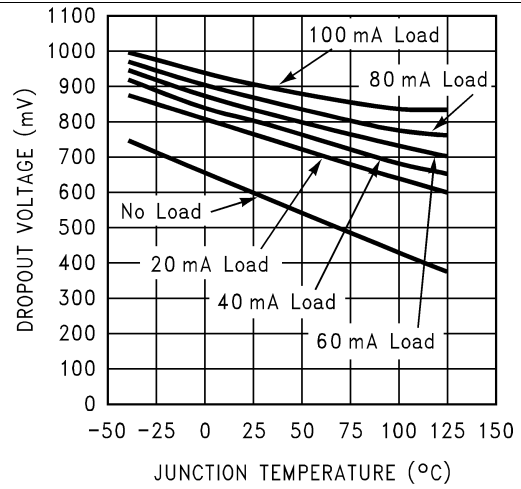

Figure 2. Dropout Voltage vs Junction Temperature

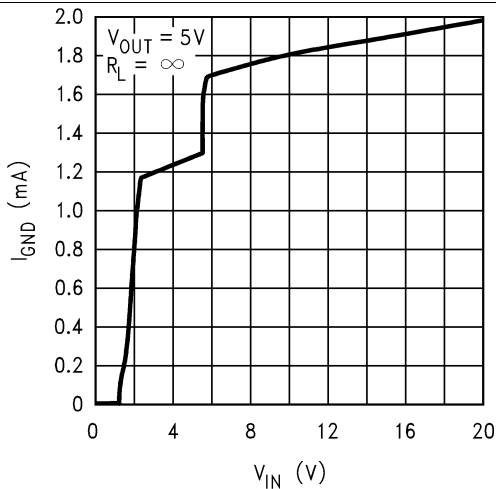

Figure 3. Ground Pin Current vs Input Voltage

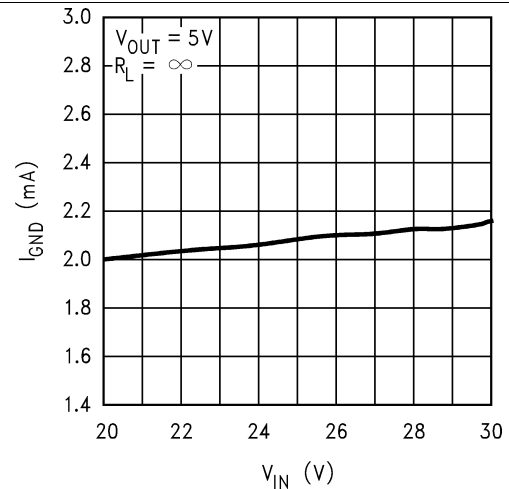

Figure 4. Ground Pin Current vs Input Voltage

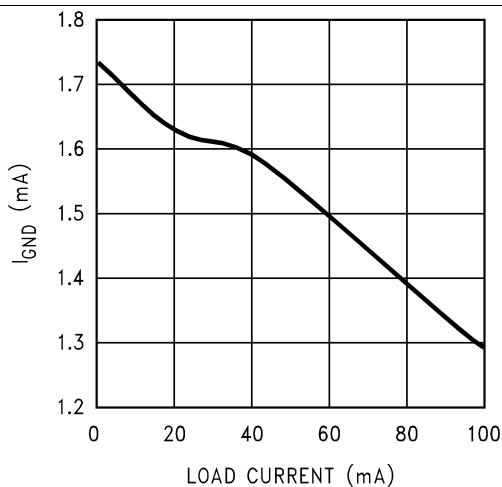

Figure 5. Ground Pin Current vs Load Current

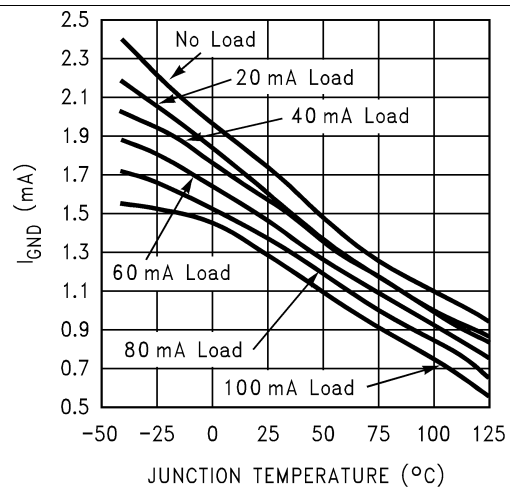

Figure 6. Ground Pin Current vs Junction Temperature

Typical Characteristics (continued)

Unless indicated otherwise, $V_{IN} = V_{NOM} + 1.5\text{ V}$, $C_{IN} = 0.1\ \mu\text{F}$, $C_{OUT} = 0.1\ \mu\text{F}$, and $T_A = 25^\circ\text{C}$.

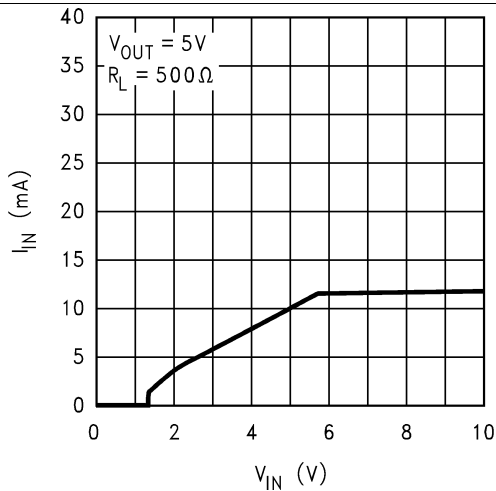

Figure 7. Input Current vs Input Voltage

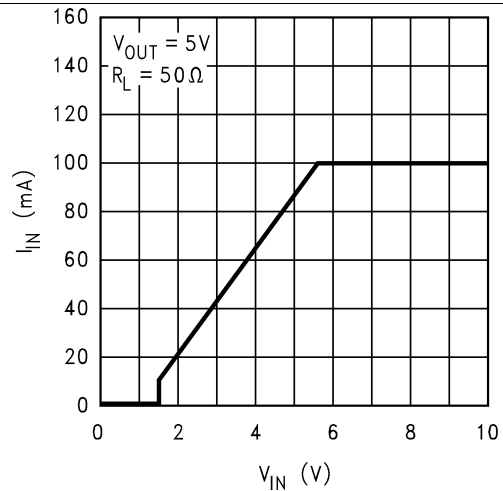

Figure 8. Input Current vs Input Voltage

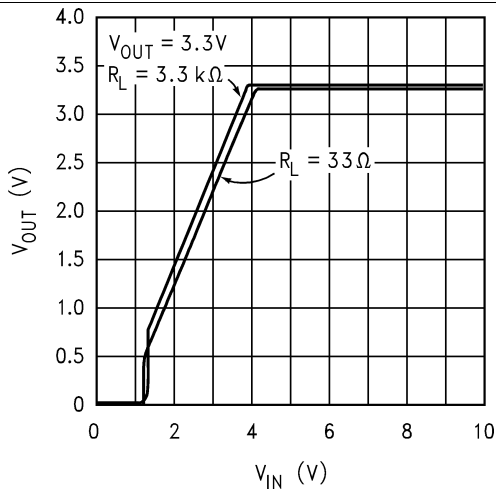

Figure 9. Output Voltage vs Input Voltage

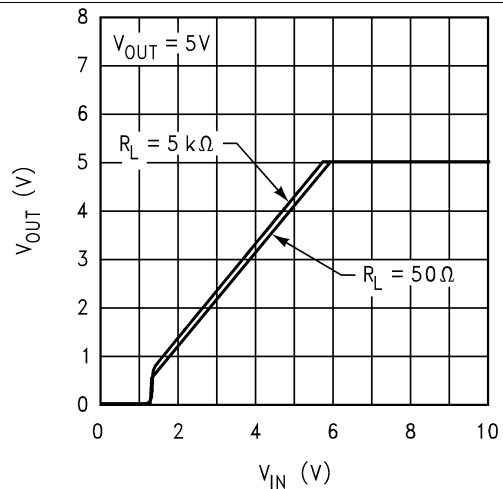

Figure 10. Output Voltage vs Input Voltage

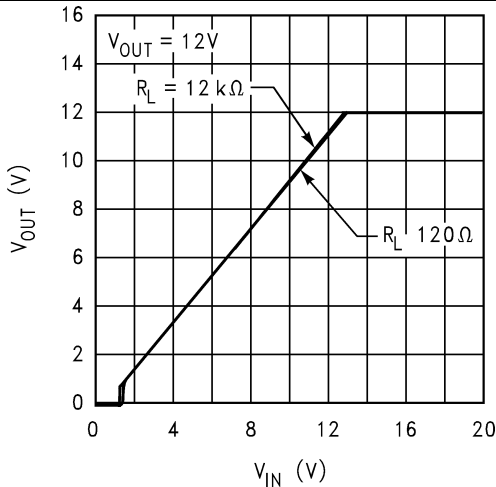

Figure 11. Output Voltage vs Input Voltage

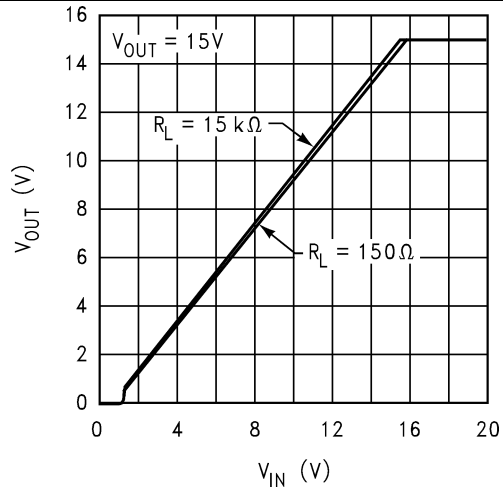

Figure 12. Output Voltage vs Input Voltage

Typical Characteristics (continued)

Unless indicated otherwise, $V_{IN} = V_{NOM} + 1.5\text{ V}$, $C_{IN} = 0.1\ \mu\text{F}$, $C_{OUT} = 0.1\ \mu\text{F}$, and $T_A = 25^\circ\text{C}$.

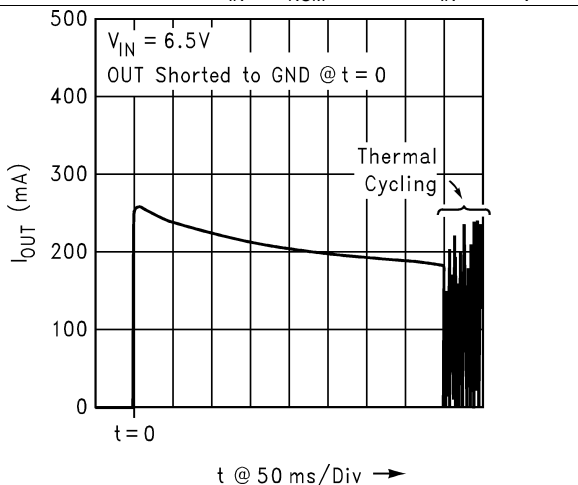

Figure 13. Output Short-Circuit Current

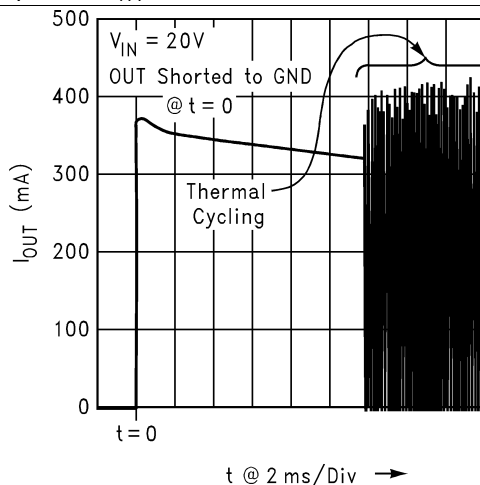

Figure 14. Output Short-Circuit Current

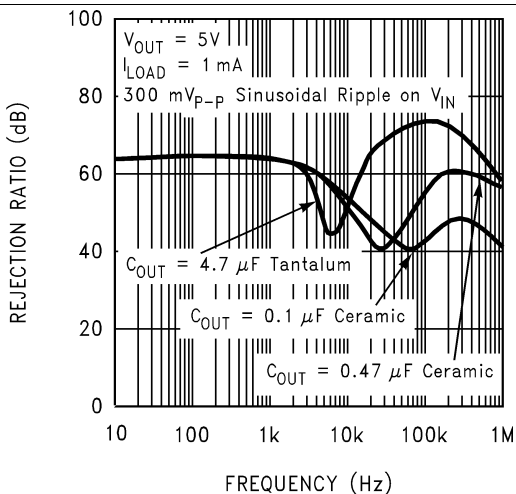

Figure 15. Power Supply Rejection Ratio

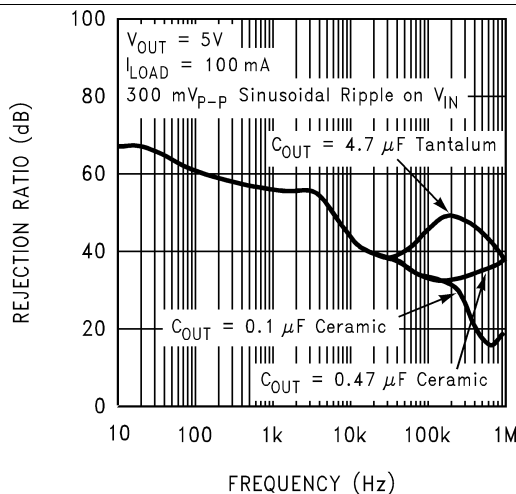

Figure 16. Power Supply Rejection Ratio

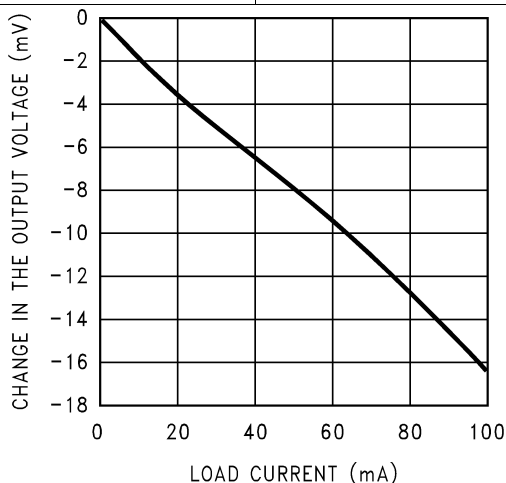

Figure 17. DC Load Regulation

8 Application and Implementation

NOTE

Information in the following applications sections is not part of the TI component specification, and TI does not warrant its accuracy or completeness. TI's customers are responsible for determining suitability of components for their purposes. Customers should validate and test their design implementation to confirm system functionality.

8.1 Application Information

The LM3480 is a linear voltage regulator with 1.2-V ensured maximum dropout and 100-mA ensured minimum load current. This device has 3.3-V, 5-V, 12-V, and 15-V versions. The implementation of LM3480 is discussed in this section.

8.2 Typical Application

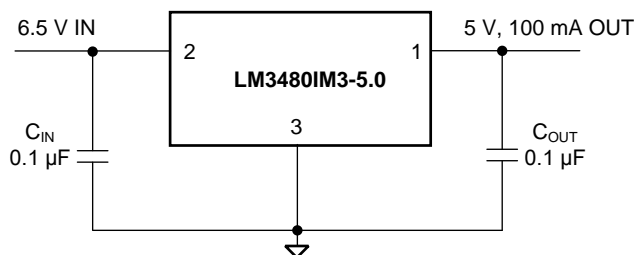

8.2.1 Design Requirements

DESIGN PARAMETER	EXAMPLE VALUE
Input voltage	6.5 V
Output voltage	5 V
Output current	100 mA

8.2.2 Detailed Design Procedure

8.2.2.1 External Capacitors

A minimum input and output capacitance value of 0.1 μF is required for stability and adequate transient performance. There is no specific ESR limitation, although excessively high ESR will compromise transient performance. There is no specific limitation on a maximum capacitance value on the input or the output.

8.2.2.1.1 Output Capacitor

The minimum output capacitance required to maintain stability is 0.1 μF . Larger values of output capacitance can be used to improve transient behavior.

8.2.3 Application Curves

Unless indicated otherwise, $V_{\text{IN}} = 6.5 \text{ V}$, $V_{\text{OUT}} = 5 \text{ V}$, $C_{\text{OUT}} = 0.1 \mu\text{F}$, and $T_{\text{A}} = 25^\circ\text{C}$

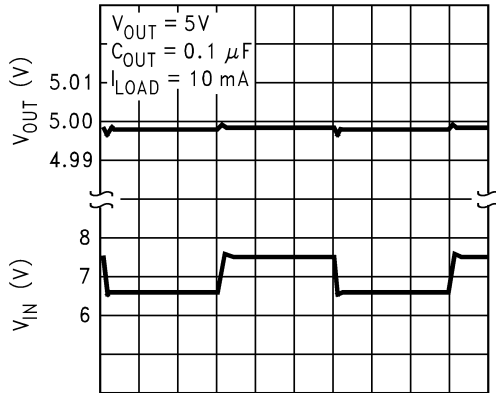
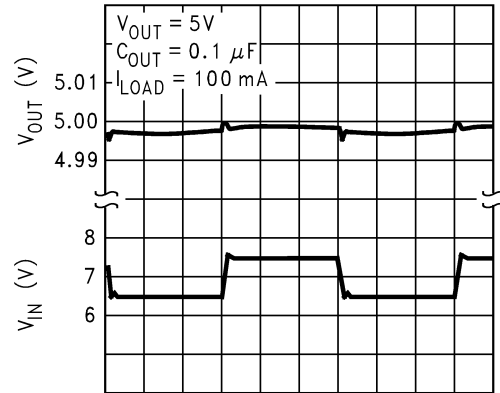
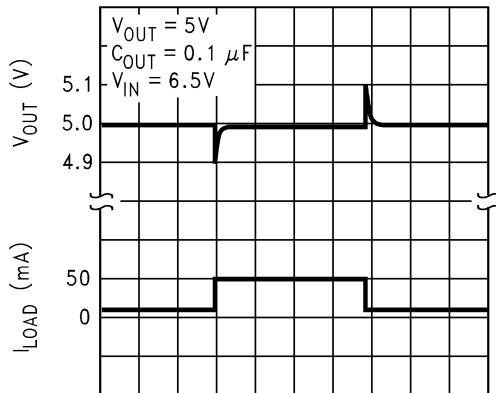
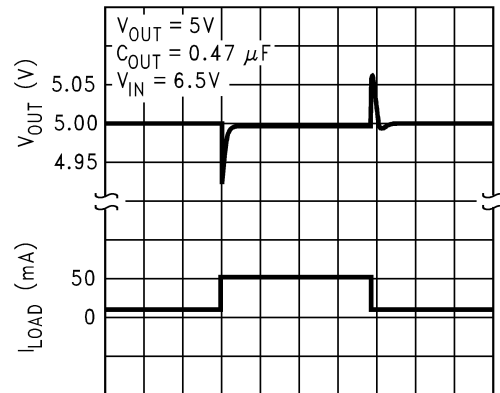
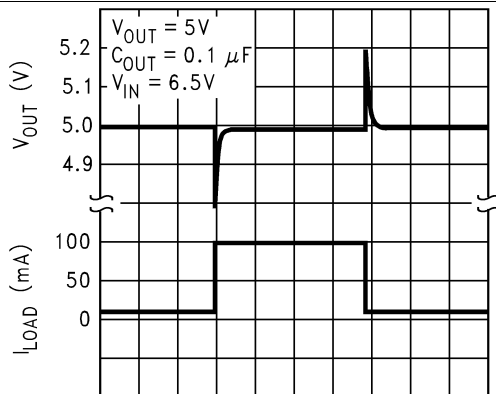
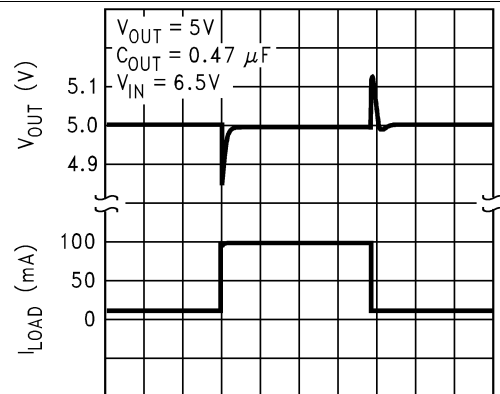
 200 $\mu\text{s}/\text{Div}$
Figure 18. Line Transient Response

 200 $\mu\text{s}/\text{Div}$
Figure 19. Line Transient Response

 50 $\mu\text{s}/\text{Div}$
Figure 20. Load Transient Response

 50 $\mu\text{s}/\text{Div}$
Figure 21. Load Transient Response

 50 $\mu\text{s}/\text{Div}$
Figure 22. Load Transient Response

 50 $\mu\text{s}/\text{Div}$
Figure 23. Load Transient Response

9 Power Supply Recommendations

The LM3480 is designed to operate from up to a 30-V input voltage supply. This input supply must be well regulated. If the input supply is noisy, additional input capacitors with low ESR can help to improve the output noise performance.

10 Layout

10.1 Layout Guidelines

For best overall performance, place all the circuit components on the same side of the circuit board and as near as practical to the respective LDO pin connections. Place ground return connections to the input and output capacitors, and to the LDO ground pin as close to each other as possible, connected by a wide, component-side, copper surface. The use of vias and long traces to create LDO circuit connections is strongly discouraged and negatively affects system performance. This grounding and layout scheme minimizes the inductive parasitic, and thereby reduces load-current transients, minimizes noise, and increases circuit stability.

A ground reference plane is also recommended and is either embedded in the PCB itself or located on the bottom side of the PCB opposite the components. This reference plane serves to assure accuracy of the output voltage, shield noise, and behaves similar to a thermal plane to spread heat from the LDO device. In most applications, this ground plane is necessary to meet thermal requirements.

10.2 Layout Example

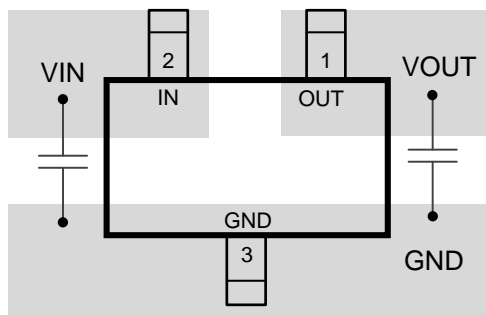

11 Device and Documentation Support

11.1 Community Resources

The following links connect to TI community resources. Linked contents are provided "AS IS" by the respective contributors. They do not constitute TI specifications and do not necessarily reflect TI's views; see TI's [Terms of Use](#).

TI E2E™ Online Community *TI's Engineer-to-Engineer (E2E) Community*. Created to foster collaboration among engineers. At e2e.ti.com, you can ask questions, share knowledge, explore ideas and help solve problems with fellow engineers.

Design Support *TI's Design Support* Quickly find helpful E2E forums along with design support tools and contact information for technical support.

11.2 Trademarks

E2E is a trademark of Texas Instruments.
All other trademarks are the property of their respective owners.

11.3 Electrostatic Discharge Caution



These devices have limited built-in ESD protection. The leads should be shorted together or the device placed in conductive foam during storage or handling to prevent electrostatic damage to the MOS gates.

11.4 Glossary

[SLYZ022](#) — *TI Glossary*.

This glossary lists and explains terms, acronyms, and definitions.

12 Mechanical, Packaging, and Orderable Information

The following pages include mechanical, packaging, and orderable information. This information is the most current data available for the designated devices. This data is subject to change without notice and revision of this document. For browser-based versions of this data sheet, refer to the left-hand navigation.

PACKAGING INFORMATION

Orderable Device	Status (1)	Package Type	Package Drawing	Pins	Package Qty	Eco Plan (2)	Lead finish/ Ball material (6)	MSL Peak Temp (3)	Op Temp (°C)	Device Marking (4/5)	Samples
LM3480IM3-12/NOPB	ACTIVE	SOT-23	DBZ	3	1000	RoHS & Green	SN	Level-1-260C-UNLIM	-40 to 125	L0C	Samples
LM3480IM3-15/NOPB	ACTIVE	SOT-23	DBZ	3	1000	RoHS & Green	SN	Level-1-260C-UNLIM	-40 to 125	L0D	Samples
LM3480IM3-3.3/NOPB	ACTIVE	SOT-23	DBZ	3	1000	RoHS & Green	SN	Level-1-260C-UNLIM	-40 to 125	L0A	Samples
LM3480IM3-5.0/NOPB	ACTIVE	SOT-23	DBZ	3	1000	RoHS & Green	SN	Level-1-260C-UNLIM	-40 to 125	L0B	Samples
LM3480IM3X-12/NOPB	ACTIVE	SOT-23	DBZ	3	3000	RoHS & Green	SN	Level-1-260C-UNLIM	-40 to 125	L0C	Samples
LM3480IM3X-15/NOPB	ACTIVE	SOT-23	DBZ	3	3000	RoHS & Green	SN	Level-1-260C-UNLIM	-40 to 125	L0D	Samples
LM3480IM3X-3.3/NOPB	ACTIVE	SOT-23	DBZ	3	3000	RoHS & Green	SN	Level-1-260C-UNLIM	-40 to 125	L0A	Samples
LM3480IM3X-5.0/NOPB	ACTIVE	SOT-23	DBZ	3	3000	RoHS & Green	SN	Level-1-260C-UNLIM	-40 to 125	L0B	Samples

(1) The marketing status values are defined as follows:

ACTIVE: Product device recommended for new designs.

LIFEBUY: TI has announced that the device will be discontinued, and a lifetime-buy period is in effect.

NRND: Not recommended for new designs. Device is in production to support existing customers, but TI does not recommend using this part in a new design.

PREVIEW: Device has been announced but is not in production. Samples may or may not be available.

OBSOLETE: TI has discontinued the production of the device.

(2) **RoHS:** TI defines "RoHS" to mean semiconductor products that are compliant with the current EU RoHS requirements for all 10 RoHS substances, including the requirement that RoHS substance do not exceed 0.1% by weight in homogeneous materials. Where designed to be soldered at high temperatures, "RoHS" products are suitable for use in specified lead-free processes. TI may reference these types of products as "Pb-Free".

RoHS Exempt: TI defines "RoHS Exempt" to mean products that contain lead but are compliant with EU RoHS pursuant to a specific EU RoHS exemption.

Green: TI defines "Green" to mean the content of Chlorine (Cl) and Bromine (Br) based flame retardants meet JS709B low halogen requirements of <=1000ppm threshold. Antimony trioxide based flame retardants must also meet the <=1000ppm threshold requirement.

(3) MSL, Peak Temp. - The Moisture Sensitivity Level rating according to the JEDEC industry standard classifications, and peak solder temperature.

(4) There may be additional marking, which relates to the logo, the lot trace code information, or the environmental category on the device.

(5) Multiple Device Markings will be inside parentheses. Only one Device Marking contained in parentheses and separated by a "~" will appear on a device. If a line is indented then it is a continuation of the previous line and the two combined represent the entire Device Marking for that device.

⁽⁶⁾ Lead finish/Ball material - Orderable Devices may have multiple material finish options. Finish options are separated by a vertical ruled line. Lead finish/Ball material values may wrap to two lines if the finish value exceeds the maximum column width.

Important Information and Disclaimer:The information provided on this page represents TI's knowledge and belief as of the date that it is provided. TI bases its knowledge and belief on information provided by third parties, and makes no representation or warranty as to the accuracy of such information. Efforts are underway to better integrate information from third parties. TI has taken and continues to take reasonable steps to provide representative and accurate information but may not have conducted destructive testing or chemical analysis on incoming materials and chemicals. TI and TI suppliers consider certain information to be proprietary, and thus CAS numbers and other limited information may not be available for release.

In no event shall TI's liability arising out of such information exceed the total purchase price of the TI part(s) at issue in this document sold by TI to Customer on an annual basis.

TAPE AND REEL INFORMATION

QUADRANT ASSIGNMENTS FOR PIN 1 ORIENTATION IN TAPE

*All dimensions are nominal

Device	Package Type	Package Drawing	Pins	SPQ	Reel Diameter (mm)	Reel Width W1 (mm)	A0 (mm)	B0 (mm)	K0 (mm)	P1 (mm)	W (mm)	Pin1 Quadrant
LM3480IM3-12/NOPB	SOT-23	DBZ	3	1000	178.0	8.4	3.3	2.9	1.22	4.0	8.0	Q3
LM3480IM3-15/NOPB	SOT-23	DBZ	3	1000	178.0	8.4	3.3	2.9	1.22	4.0	8.0	Q3
LM3480IM3-3.3/NOPB	SOT-23	DBZ	3	1000	178.0	8.4	3.3	2.9	1.22	4.0	8.0	Q3
LM3480IM3-5.0/NOPB	SOT-23	DBZ	3	1000	178.0	8.4	3.3	2.9	1.22	4.0	8.0	Q3
LM3480IM3X-12/NOPB	SOT-23	DBZ	3	3000	178.0	8.4	3.3	2.9	1.22	4.0	8.0	Q3
LM3480IM3X-15/NOPB	SOT-23	DBZ	3	3000	178.0	8.4	3.3	2.9	1.22	4.0	8.0	Q3
LM3480IM3X-3.3/NOPB	SOT-23	DBZ	3	3000	178.0	8.4	3.3	2.9	1.22	4.0	8.0	Q3
LM3480IM3X-5.0/NOPB	SOT-23	DBZ	3	3000	178.0	8.4	3.3	2.9	1.22	4.0	8.0	Q3

TAPE AND REEL BOX DIMENSIONS

*All dimensions are nominal

Device	Package Type	Package Drawing	Pins	SPQ	Length (mm)	Width (mm)	Height (mm)
LM3480IM3-12/NOPB	SOT-23	DBZ	3	1000	208.0	191.0	35.0
LM3480IM3-15/NOPB	SOT-23	DBZ	3	1000	208.0	191.0	35.0
LM3480IM3-3.3/NOPB	SOT-23	DBZ	3	1000	208.0	191.0	35.0
LM3480IM3-5.0/NOPB	SOT-23	DBZ	3	1000	208.0	191.0	35.0
LM3480IM3X-12/NOPB	SOT-23	DBZ	3	3000	208.0	191.0	35.0
LM3480IM3X-15/NOPB	SOT-23	DBZ	3	3000	208.0	191.0	35.0
LM3480IM3X-3.3/NOPB	SOT-23	DBZ	3	3000	208.0	191.0	35.0
LM3480IM3X-5.0/NOPB	SOT-23	DBZ	3	3000	208.0	191.0	35.0

EXAMPLE BOARD LAYOUT

DBZ0003A

SOT-23 - 1.12 mm max height

SMALL OUTLINE TRANSISTOR

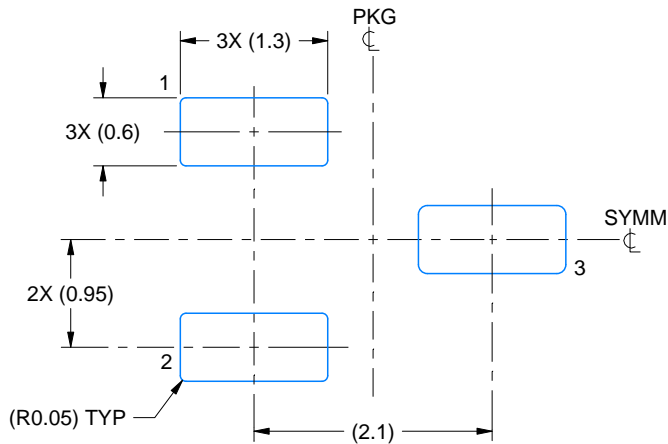

LAND PATTERN EXAMPLE
SCALE:15X

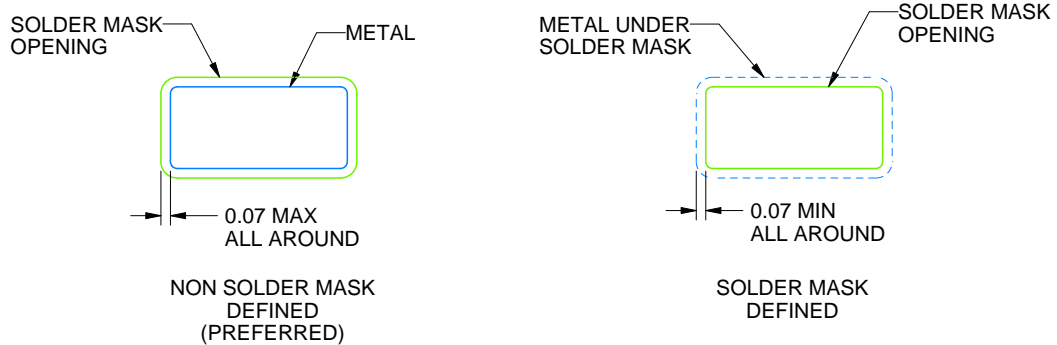

SOLDER MASK DETAILS

4214838/D 03/2023

NOTES: (continued)

4. Publication IPC-7351 may have alternate designs.
5. Solder mask tolerances between and around signal pads can vary based on board fabrication site.

EXAMPLE STENCIL DESIGN

DBZ0003A

SOT-23 - 1.12 mm max height

SMALL OUTLINE TRANSISTOR

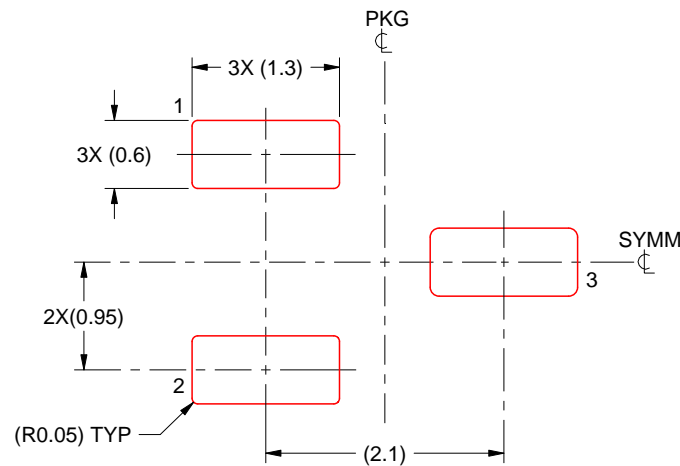

SOLDER PASTE EXAMPLE
BASED ON 0.125 THICK STENCIL
SCALE:15X

4214838/D 03/2023

NOTES: (continued)

6. Laser cutting apertures with trapezoidal walls and rounded corners may offer better paste release. IPC-7525 may have alternate design recommendations.
7. Board assembly site may have different recommendations for stencil design.

IMPORTANT NOTICE AND DISCLAIMER

TI PROVIDES TECHNICAL AND RELIABILITY DATA (INCLUDING DATA SHEETS), DESIGN RESOURCES (INCLUDING REFERENCE DESIGNS), APPLICATION OR OTHER DESIGN ADVICE, WEB TOOLS, SAFETY INFORMATION, AND OTHER RESOURCES "AS IS" AND WITH ALL FAULTS, AND DISCLAIMS ALL WARRANTIES, EXPRESS AND IMPLIED, INCLUDING WITHOUT LIMITATION ANY IMPLIED WARRANTIES OF MERCHANTABILITY, FITNESS FOR A PARTICULAR PURPOSE OR NON-INFRINGEMENT OF THIRD PARTY INTELLECTUAL PROPERTY RIGHTS.

These resources are intended for skilled developers designing with TI products. You are solely responsible for (1) selecting the appropriate TI products for your application, (2) designing, validating and testing your application, and (3) ensuring your application meets applicable standards, and any other safety, security, regulatory or other requirements.

These resources are subject to change without notice. TI grants you permission to use these resources only for development of an application that uses the TI products described in the resource. Other reproduction and display of these resources is prohibited. No license is granted to any other TI intellectual property right or to any third party intellectual property right. TI disclaims responsibility for, and you will fully indemnify TI and its representatives against, any claims, damages, costs, losses, and liabilities arising out of your use of these resources.

TI's products are provided subject to [TI's Terms of Sale](#) or other applicable terms available either on [ti.com](https://www.ti.com) or provided in conjunction with such TI products. TI's provision of these resources does not expand or otherwise alter TI's applicable warranties or warranty disclaimers for TI products.

TI objects to and rejects any additional or different terms you may have proposed.

Mailing Address: Texas Instruments, Post Office Box 655303, Dallas, Texas 75265
Copyright © 2024, Texas Instruments Incorporated

Looking for pricing, stock, or lifecycle information?

Click below to explore more details on WIN SOURCE:

 [View LM3480IM3X-3.3/NOPB on WIN SOURCE](#)

 [Texas Instruments](#) Information

Optimize Your Supply Chain with WIN SOURCE Solutions

-  Global Sourcing Solution
-  Obsolete Management
-  Cost Control Management
-  Shortage Management
-  Alternative Solution
-  Excess Inventory Management