



# THE DATASHEET OF LM4040B50FTA



## Description

The LM4040 is a family of bandgap circuits designed to achieve precision micro-power voltage references of 2.5V, 3.0V and 5.0V. The devices are available in 0.2% B-grade, 0.5% C-grade and 1% D-grade initial tolerances.

They are available in small outline SOT23 surface mount packages which are ideal for applications where space is at a premium.

Excellent performance is maintained over the 60µA to 15mA operating current range with a typical temperature coefficient of only 20ppm/°C. The device has been designed to be highly tolerant of capacitive loads so maintaining excellent stability.

This device offers a pin for pin compatible alternative to the LM4040 voltage reference.

## Features

- Small Package: SOT23
  - SC70-5 Variants Are End of Life (EOL)
- No Output Capacitor Required
- Output Voltage Tolerance
  - LM4040B ±0.2% at +25°C
  - LM4040C ±0.5% at +25°C
  - LM4040D ±1% at +25°C
- Low Output Noise
- (10Hz to 10kHz) ..... 45µVRMS
- Wide Operating Current Range 60µA to 15mA
- Extended Temperature Range -40°C to +125°C
- Low Temperature Coefficient 100 ppm/°C (max)
- Green Molding in Small Package SOT23
- **Totally Lead-Free & Fully RoHS Compliant (Notes 1 & 2)**
- **Halogen and Antimony Free. "Green" Device (Note 3)**
- **An Automotive-Compliant Part is Available Under Separate Datasheet ([LM4040Q](#))**

## Applications

- Battery Powered Equipment
- Precision Power Supplies
- Portable Instrumentation
- Portable Communications Devices
- Notebook and Palmtop Computers
- Data Acquisition Systems

Notes:

1. No purposely added lead. Fully EU Directive 2002/95/EC (RoHS) & 2011/65/EU (RoHS 2) compliant.
2. See [http://www.diodes.com/quality/lead\\_free.html](http://www.diodes.com/quality/lead_free.html) for more information about Diodes Incorporated's definitions of Halogen- and Antimony-free, "Green" and Lead-free.
3. Halogen- and Antimony-free "Green" products are defined as those which contain <900ppm bromine, <900ppm chlorine (<1500ppm total Br + Cl) and <1000ppm antimony compounds.

## Pin Assignments

(Top View)

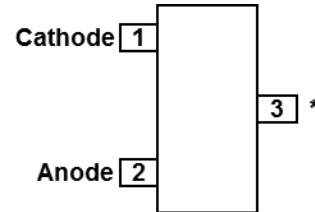

\* Pin 3 must be left floating or connected to pin 2  
**SOT23**

(Top View)

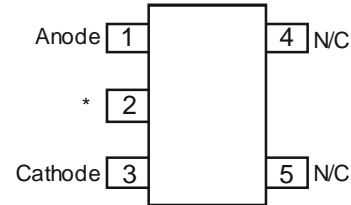

\* Pin 2 must be left floating or connected to pin 1.  
\*\* SC70-5 variants are End of Life (EOL).  
**SC70-5\*\***

**Absolute Maximum Ratings** (Voltages to Anode Unless Otherwise Stated)

Parameter	Rating	Unit
Continuous Reverse Current	20	mA
Continuous Forward Current	10	mA
Operating Junction Temperature	-40 to +150	°C
Storage Temperature	-55 to +150	°C

Caution: Stresses greater than the 'Absolute Maximum Ratings' specified above, may cause permanent damage to the device. These are stress ratings only; functional operation of the device at conditions between maximum recommended operating conditions and absolute maximum ratings is not implied. Device reliability may be affected by exposure to absolute maximum rating conditions for extended periods of time.

(Semiconductor devices are ESD sensitive and may be damaged by exposure to ESD events. Suitable ESD precautions should be taken when handling and transporting these devices.)

Unless otherwise stated voltages specified are relative to the Anode pin.

**Package Thermal Data**

Package	$\theta_{JA}$	$P_{DIS}$ $T_A = +25^\circ\text{C}, T_J = +125^\circ\text{C}$
SOT23	380°C/W	330mW

**Recommended Operating Conditions**

Parameter	Min	Max	Unit
Reverse Current	0.06	15	mA
Operating Ambient Temperature Range	-40	+125	°C

**Electrical Characteristics** (Test conditions:  $T_A = +25^\circ\text{C}$ , unless otherwise specified.)

**LM4040-2.5**

Symbol	Parameter	Conditions		Typ	LM4040 B Limits	LM4040 C Limits	LM4040 D Limits	Unit
		—	$T_A$					
$V_{REF}$	Reverse Breakdown Voltage	$I_R = 100\mu\text{A}$	+25°C	2.5	—	—	—	V
	Reverse Breakdown Voltage Tolerance	$I_R = 100\mu\text{A}$	+25°C	—	±5	±12	±25	mV
			-40 to +85°C	—	±21	±29	±49	
$I_{RMIN}$	Minimum Operating Current	—	+25°C	45	60	60	65	µA
			-40 to +85°C	—	65	65	70	
			-40 to +125°C	—	68	68	73	
$\Delta V_R/\Delta T$	Average Reverse Breakdown Voltage Temperature Coefficient	$I_R = 10\text{mA}$	-40 to +125°C	±20	—	—	—	ppm/°C
		$I_R = 1\text{mA}$		±15	±100	±100	±150	
		$I_R = 100\mu\text{A}$		±15	—	—	—	
$\Delta V_R/\Delta I_R$	Reverse Breakdown Change with Current	$I_{RMIN} \leq I_R \leq 1\text{mA}$	+25°C	0.3	0.8	0.8	1.0	mV
			-40 to +85°C	—	1.0	1.0	1.2	
			-40 to +125°C	—	1.0	1.0	1.2	
		$1\text{mA} \leq I_R \leq 15\text{mA}$	+25°C	2.5	6.0	6.0	8.0	
			-40 to +85°C	—	8.0	8.0	10.0	
			-40 to +125°C	—	8.0	8.0	10.0	
$Z_R$	Dynamic Output Impedance	$I_R = 1\text{mA}, f = 120\text{Hz}$ $I_{AC} = 0.1I_R$		0.3	0.8	0.9	1.1	Ω
$e_n$	Noise Voltage	$I_R = 100\mu\text{A}$ $10\text{Hz} < f < 10\text{kHz}$		35	—	—	—	µV <sub>RMS</sub>
$V_R$	Long Term Stability (Non Cumulative)	$t = 1000\text{Hrs}, I_R = 100\mu\text{A}$		120	—	—	—	ppm
$V_{HYST}$	Thermal Hysteresis	$\Delta T = -40^\circ\text{C to } +125^\circ\text{C}$		0.08	—	—	—	%

**Electrical Characteristics** (Cont.) (Test conditions:  $T_A = +25^\circ\text{C}$ , unless otherwise specified.)

**LM4040-3.0**

Symbol	Parameter	Conditions		Typ	LM4040 B Limits	LM4040 C Limits	LM4040 D Limits	Unit
		—	$T_A$					
$V_{REF}$	Reverse Breakdown Voltage	$I_R = 100\mu\text{A}$	$+25^\circ\text{C}$	3.0	—	—	—	V
	Reverse Breakdown Voltage Tolerance	$I_R = 100\mu\text{A}$	$+25^\circ\text{C}$ $-40$ to $+85^\circ\text{C}$ $-40$ to $+125^\circ\text{C}$	—	$\pm 6$ $\pm 26$ TBD	$\pm 15$ $\pm 34$ $\pm 45$	$\pm 30$ $\pm 59$ $\pm 75$	mV
$I_{RMIN}$	Minimum Operating Current	—	$+25^\circ\text{C}$	47	62	62	67	$\mu\text{A}$
			$-40$ to $+85^\circ\text{C}$	—	67	67	72	
			$-40$ to $+125^\circ\text{C}$	—	70	70	75	
$\Delta V_R/\Delta T$	Average Reverse Breakdown Voltage Temperature Coefficient	$I_R = 10\text{mA}$ $I_R = 1\text{mA}$ $I_R = 100\mu\text{A}$	$-40$ to $+125^\circ\text{C}$	$\pm 20$	—	—	—	ppm/ $^\circ\text{C}$
				$\pm 15$	$\pm 100$	$\pm 100$	$\pm 150$	
				$\pm 15$	—	—	—	
$\Delta V_R/\Delta I_R$	Reverse Breakdown Change with Current	$I_{RMIN} \leq I_R \leq 1\text{mA}$	$+25^\circ\text{C}$	0.4	0.8	0.8	1.0	mV
			$-40$ to $+85^\circ\text{C}$	—	1.1	1.1	1.3	
			$-40$ to $+125^\circ\text{C}$	—	1.1	1.1	1.3	
		$1\text{mA} \leq I_R \leq 15\text{mA}$	$+25^\circ\text{C}$	2.7	6.0	6.0	8.0	
			$-40$ to $+85^\circ\text{C}$	—	9.0	9.0	11.0	
			$-40$ to $+125^\circ\text{C}$	—	9.0	9.0	11.0	
$Z_R$	Dynamic Output Impedance	$I_R = 1\text{mA}$ , $f = 120\text{Hz}$ $I_{AC} = 0.1I_R$		0.4	0.9	0.9	1.2	$\Omega$
$e_n$	Noise Voltage	$I_R = 100\mu\text{A}$ $10\text{Hz} < f < 10\text{kHz}$		35	—	—	—	$\mu\text{V}_{RMS}$
$V_R$	Long Term Stability (Non Cumulative)	$t = 1000\text{Hrs}$ , $I_R = 100\mu\text{A}$		120	—	—	—	ppm
$V_{HYST}$	Thermal Hysteresis	$\Delta T = -40^\circ\text{C}$ to $+125^\circ\text{C}$		0.08	—	—	—	%

**Electrical Characteristics** (Cont.) (Test conditions:  $T_A = +25^\circ\text{C}$ , unless otherwise specified.)

**LM4040-5.0**

Symbol	Parameter	Conditions		Typ	LM4040 B Limits	LM4040 C Limits	LM4040 D Limits	Units
		—	$T_A$					
$V_{REF}$	Reverse Breakdown Voltage	$I_R = 100\mu\text{A}$	$+25^\circ\text{C}$	5.0	—	—	—	V
	Reverse Breakdown Voltage Tolerance	$I_R = 100\mu\text{A}$	$+25^\circ\text{C}$ $-40$ to $+85^\circ\text{C}$ $-40$ to $+125^\circ\text{C}$	—	$\pm 10$ $\pm 43$ $\pm 60$	$\pm 25$ $\pm 58$ $\pm 75$	$\pm 50$ $\pm 99$ $\pm 125$	mV
$I_{RMIN}$	Minimum Operating Current	—	$+25^\circ\text{C}$	54	74	74	79	$\mu\text{A}$
			$-40$ to $+85^\circ\text{C}$	—	80	80	85	
			$-40$ to $+125^\circ\text{C}$	—	83	83	88	
$\Delta V_R/\Delta T$	Average Reverse Breakdown Voltage Temperature Coefficient	$I_R = 10\text{mA}$ $I_R = 1\text{mA}$ $I_R = 100\mu\text{A}$	$-40$ to $+125^\circ\text{C}$	$\pm 30$	—	—	—	ppm/ $^\circ\text{C}$
				$\pm 20$	$\pm 100$	$\pm 100$	$\pm 150$	
				$\pm 20$	—	—	—	
$\Delta V_R/\Delta I_R$	Reverse Breakdown Change with Current	$I_{RMIN} \leq I_R \leq 1\text{mA}$	$+25^\circ\text{C}$	0.5	1.0	1.0	1.3	mV
			$-40$ to $+85^\circ\text{C}$	—	1.4	1.4	1.8	
			$-40$ to $+125^\circ\text{C}$	—	1.4	1.4	1.8	
		$1\text{mA} \leq I_R \leq 15\text{mA}$	$+25^\circ\text{C}$	3.5	8.0	8.0	10.0	
			$-40$ to $+85^\circ\text{C}$	—	12.0	12.0	15.0	
			$-40$ to $+125^\circ\text{C}$	—	12.0	12.0	15.0	
$Z_R$	Dynamic Output Impedance	$I_R = 1\text{mA}$ , $f = 120\text{Hz}$ $I_{AC} = 0.1I_R$		0.5	1.1	1.1	1.5	$\Omega$
$e_n$	Noise Voltage	$I_R = 100\mu\text{A}$ $10\text{Hz} < f < 10\text{kHz}$		80	—	—	—	$\mu\text{V}_{RMS}$
$V_R$	Long Term Stability (Non Cumulative)	$t = 1000\text{Hrs}$ , $I_R = 100\mu\text{A}$		120	—	—	—	ppm
$V_{HYST}$	Thermal Hysteresis	$\Delta T = -40^\circ\text{C}$ to $+125^\circ\text{C}$		0.08	—	—	—	%

**Typical Characteristics LM4040-2.5**

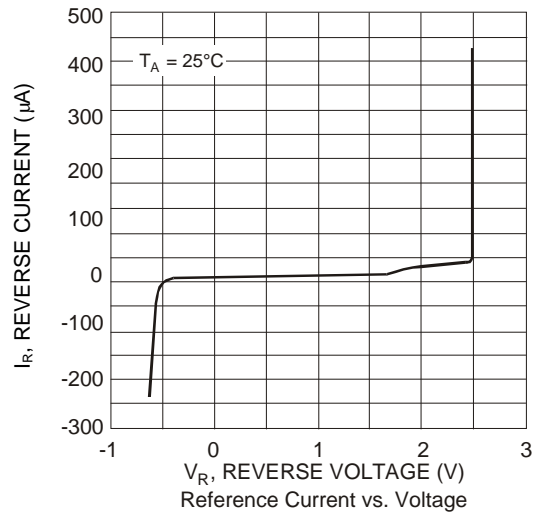
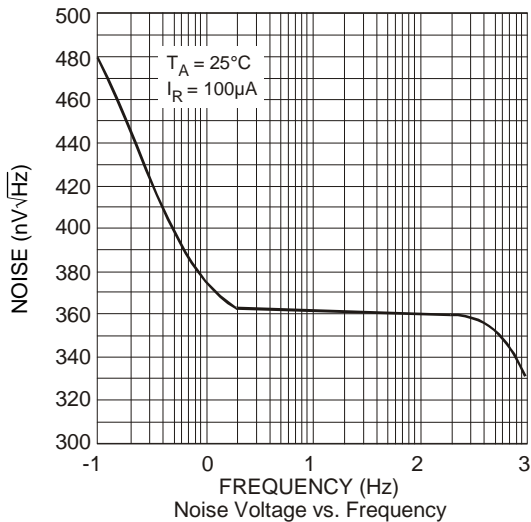
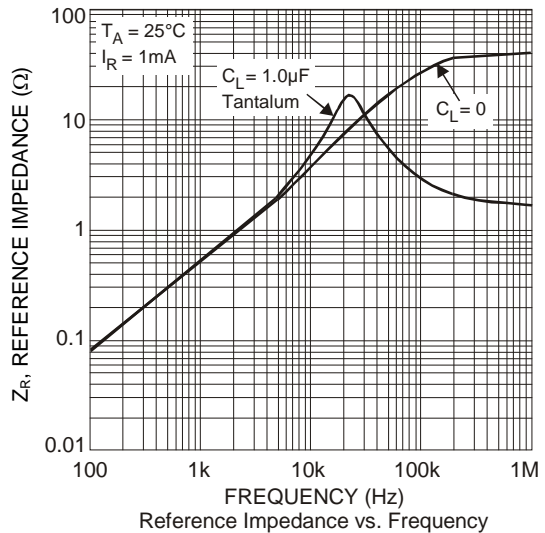
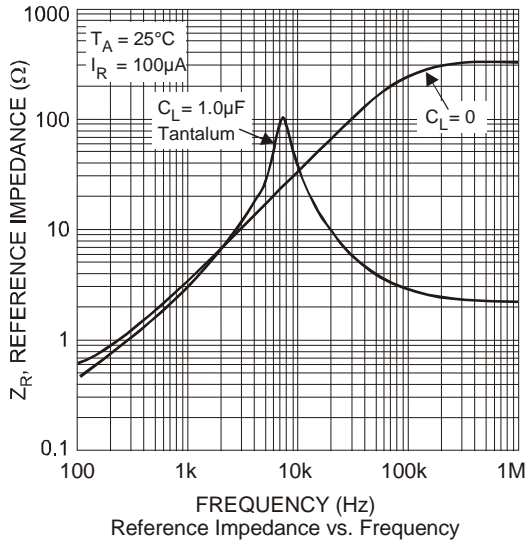
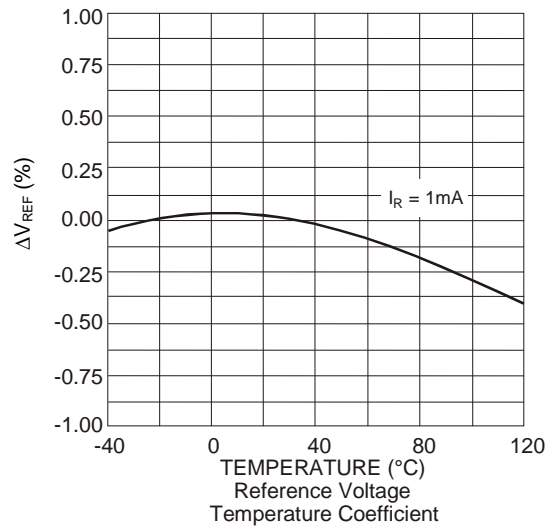
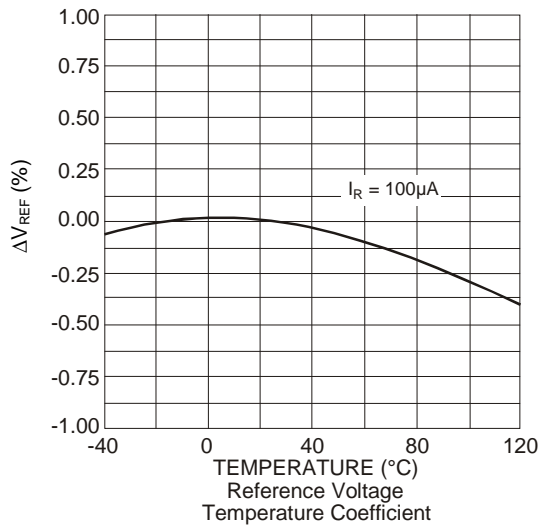

**Typical Characteristics LM4040-3.0**

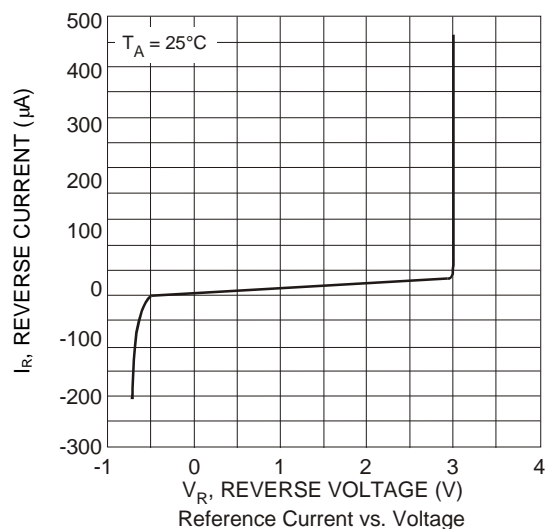
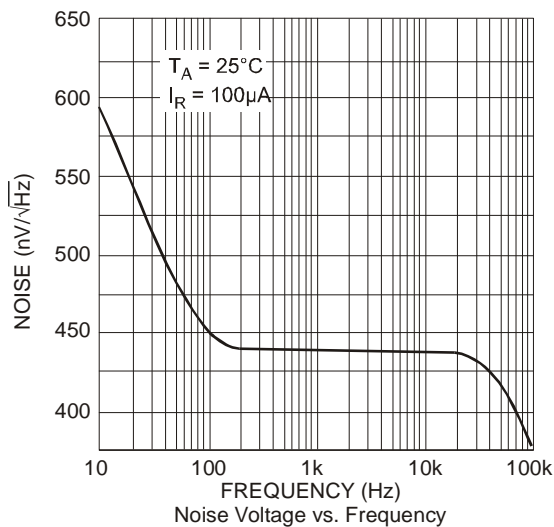
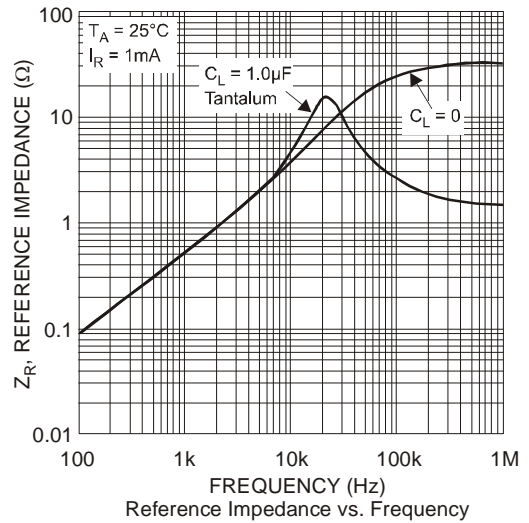
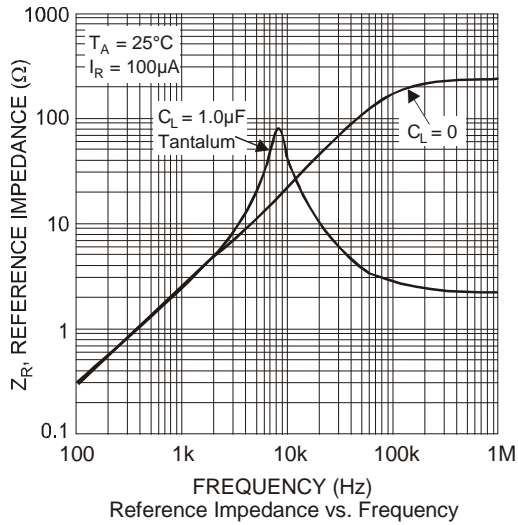
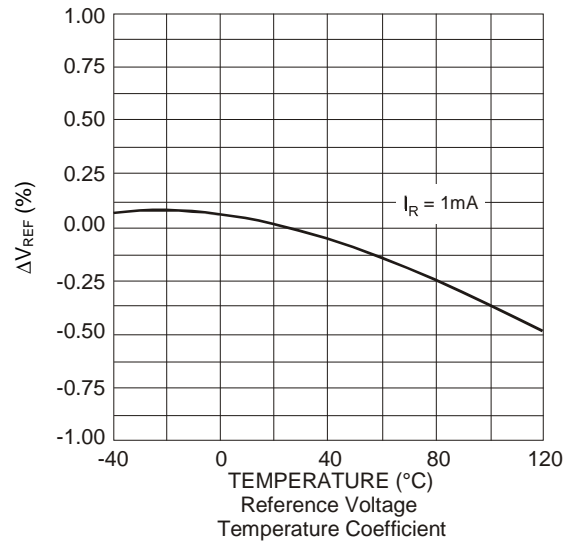
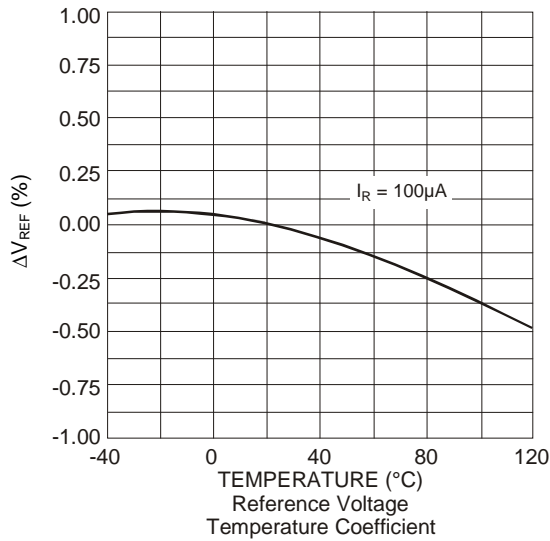

**Typical Characteristics LM4040-5.0**

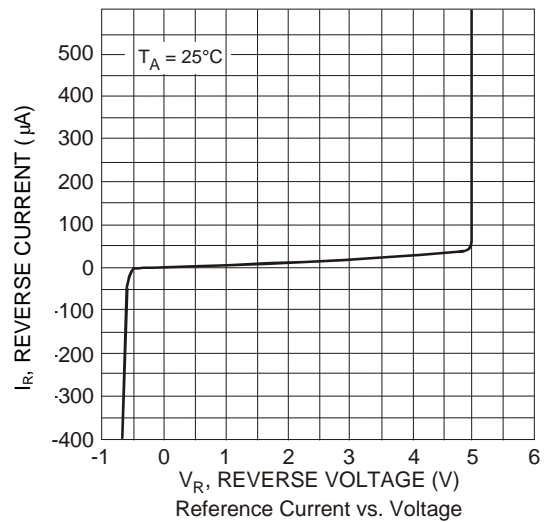
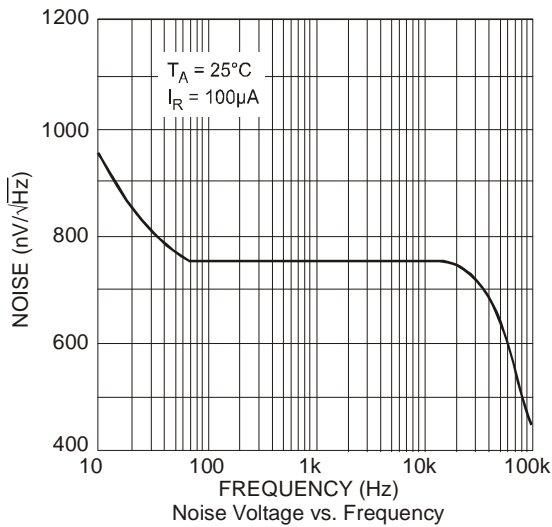
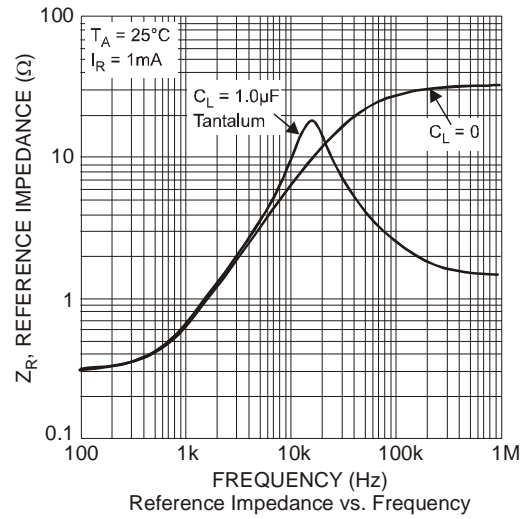
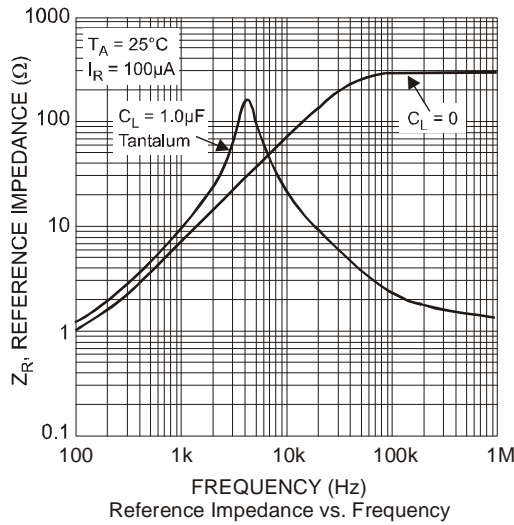
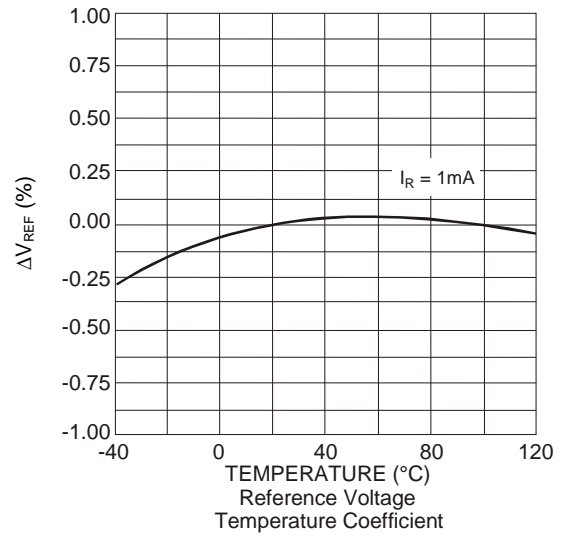
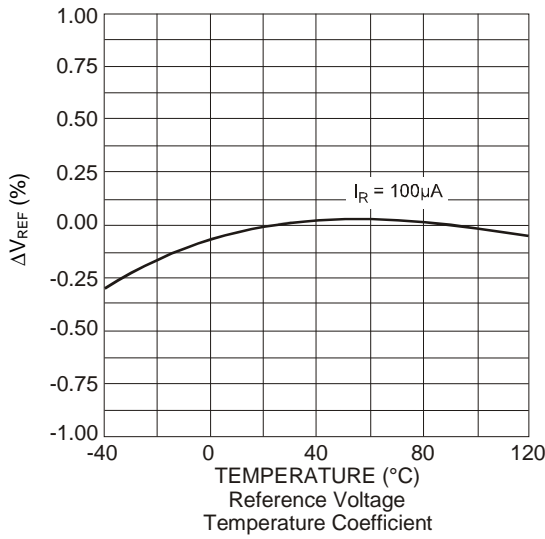

**Start Up Characteristics LM4040-2.5, 3.0 and 5.0**

**LM4040-2.5**

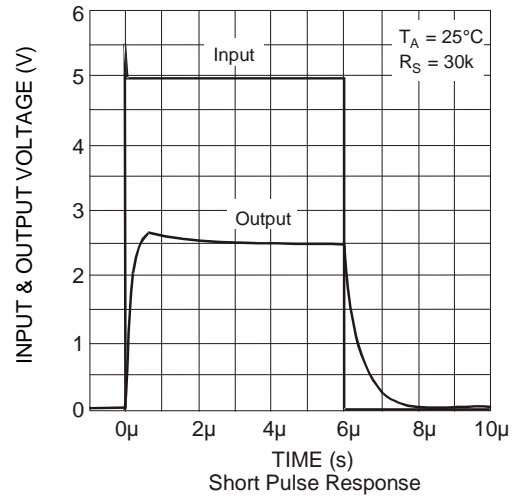
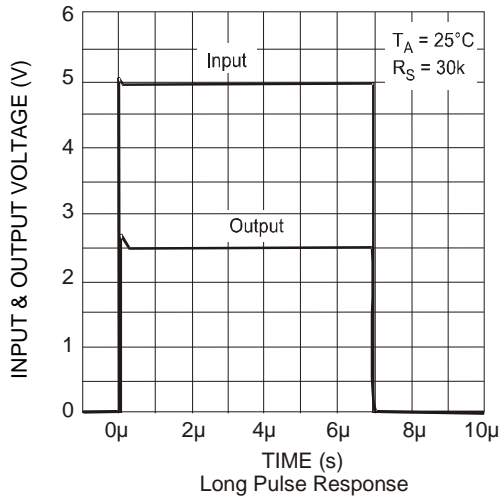

**LM4040-3.0**

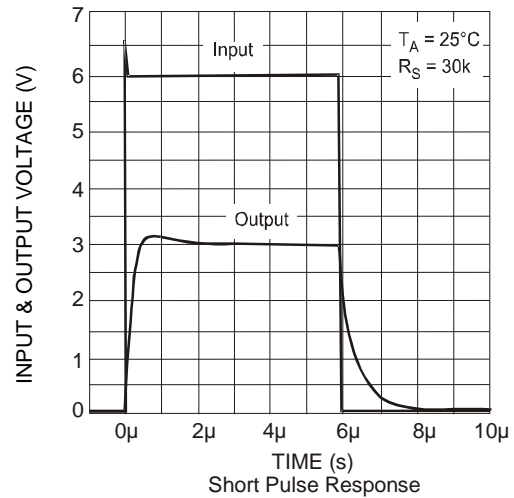
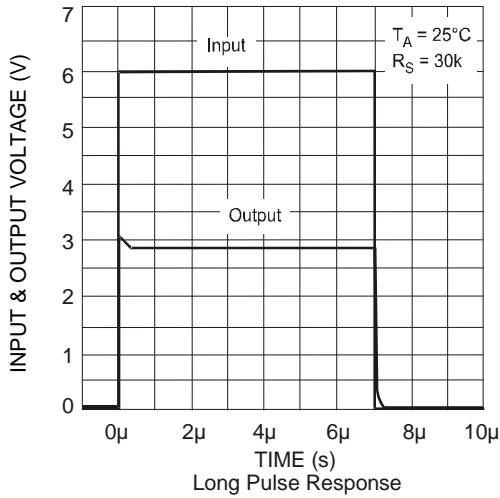

**LM4040-5.0**

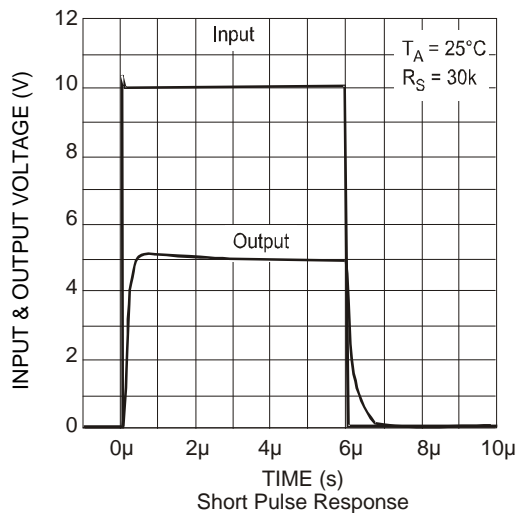
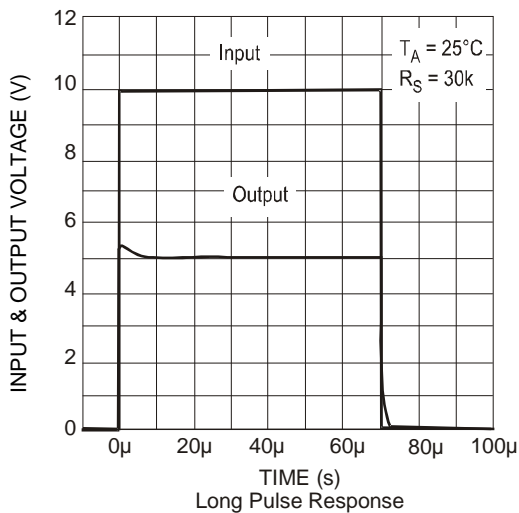

## Application Information

In a conventional shunt regulator application (Figure 1), an external series resistor ( $R_S$ ) is connected between the supply voltage,  $V_S$ , and the LM4040.

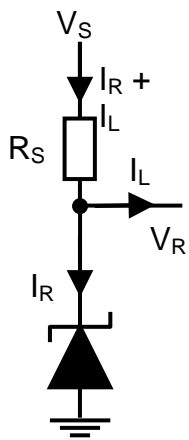

$R_S$  determines the current that flows through the load ( $I_L$ ) and the LM4040 ( $I_R$ ). Since load current and supply voltage may vary,  $R_S$  should be small enough to supply at least the minimum acceptable  $I_R$  to the LM4040 even when the supply voltage is at its minimum and the load current is at its maximum value. When the supply voltage is at its maximum and  $I_L$  is at its minimum,  $R_S$  should be large enough so that the current flowing through the LM4040 is less than 15mA.

$R_S$  is determined by the supply voltage, ( $V_S$ ), the load and operating current, ( $I_L$  and  $I_R$ ), and the LM4040's reverse breakdown voltage,  $V_R$ .

$$R_S = \frac{V_S - V_R}{I_L + I_R}$$

Figure 1

### Printed Circuit Board Layout Considerations

LM4040s in the SOT23 package have the die attached to pin 1, which results in an electrical contact between pin 2 and pin 3. Therefore, pin 1 of the SOT23 package must be left floating or connected to pin 2.

LM4040s in the SC70-5 (Note 4) package have the die attached to pin 2, which results in an electrical contact between pin 2 and pin 1. Therefore, pin 2 must be left floating or connected to pin 1.

Note: 4. SC70-5 variants are End of Life (EOL).

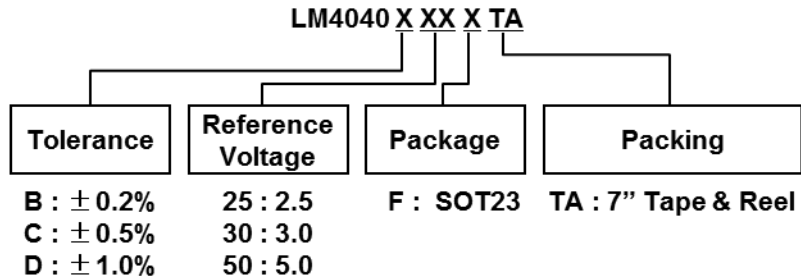
**Ordering Information**

+25°C Tol	Voltage (V)	Part Number	Status (Note 4)	Package (Note 5)	Identification Code	Reel Size	Tape Width	Quantity per Reel
0.2%	2.5	LM4040B25FTA	Full Production	SOT23	R2B	7", 180mm	8mm	3000
		LM4040B25H5TA	End of Life	SC70-5	R2B	7", 180mm	8mm	3000
	3.0	LM4040B30FTA	Full Production	SOT23	R3B	7", 180mm	8mm	3000
		LM4040B30H5TA	End of Life	SC70-5	R3B	7", 180mm	8mm	3000
	5.0	LM4040B50FTA	Full Production	SOT23	R5B	7", 180mm	8mm	3000
		LM4040B50H5TA	End of Life	SC70-5	R5B	7", 180mm	8mm	3000
0.5%	2.5	LM4040C25FTA	Full Production	SOT23	R2C	7", 180mm	8mm	3000
		LM4040C25H5TA	End of Life	SC70-5	R2C	7", 180mm	8mm	3000
	3.0	LM4040C30FTA	Full Production	SOT23	R3C	7", 180mm	8mm	3000
		LM4040C30H5TA	End of Life	SC70-5	R3C	7", 180mm	8mm	3000
	5.0	LM4040C50FTA	Full Production	SOT23	R5C	7", 180mm	8mm	3000
		LM4040C50H5TA	End of Life	SC70-5	R5C	7", 180mm	8mm	3000
1%	2.5	LM4040D25FTA	Full Production	SOT23	R2D	7", 180mm	8mm	3000
		LM4040D25H5TA	End of Life	SC70-5	R2D	7", 180mm	8mm	3000
	3.0	LM4040D30FTA	Full Production	SOT23	R3D	7", 180mm	8mm	3000
		LM4040D30H5TA	End of Life	SC70-5	R3D	7", 180mm	8mm	3000
	5.0	LM4040D50FTA	Full Production	SOT23	R5D	7", 180mm	8mm	3000
		LM4040D50H5TA	End of Life	SC70-5	R5D	7", 180mm	8mm	3000

Notes: 4. SC70-5 variants are End of Life.  
5. Package dimensions and pad layout can be found on our website at <http://www.diodes.com/package-outlines.html>.

**Marking Information**

(1) SOT23

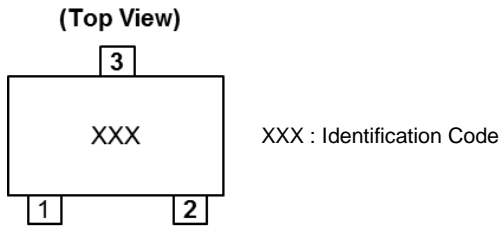

Part Number	Identification Code
LM4040B25FTA	R2B
LM4040B30FTA	R3B
LM4040B50FTA	R5B
LM4040C25FTA	R2C
LM4040C30FTA	R3C
LM4040C50FTA	R5C
LM4040D25FTA	R2D
LM4040D30FTA	R3D
LM4040D50FTA	R5D

(2) SC70-5 (Note 4)

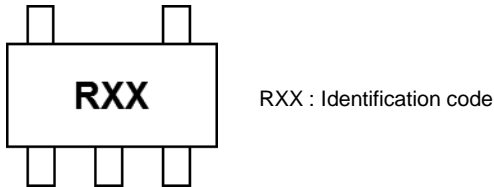

**Package Outline Dimensions**

Please see <http://www.diodes.com/package-outlines.html> for the latest version.

(1) Package Type: SOT23

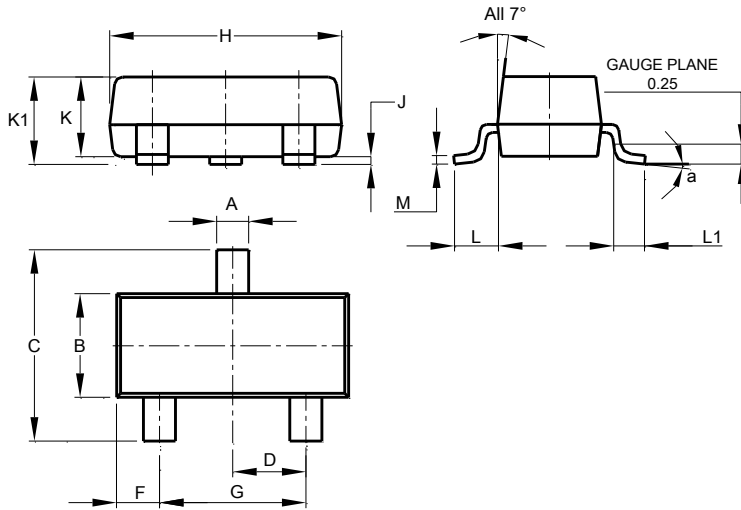

SOT23			
Dim	Min	Max	Typ
A	0.37	0.51	0.40
B	1.20	1.40	1.30
C	2.30	2.50	2.40
D	0.89	1.03	0.915
F	0.45	0.60	0.535
G	1.78	2.05	1.83
H	2.80	3.00	2.90
J	0.013	0.10	0.05
K	0.890	1.00	0.975
K1	0.903	1.10	1.025
L	0.45	0.61	0.55
L1	0.25	0.55	0.40
M	0.085	0.150	0.110
a	0°	8°	--
All Dimensions in mm			

(2) SC70-5 (Note 4)

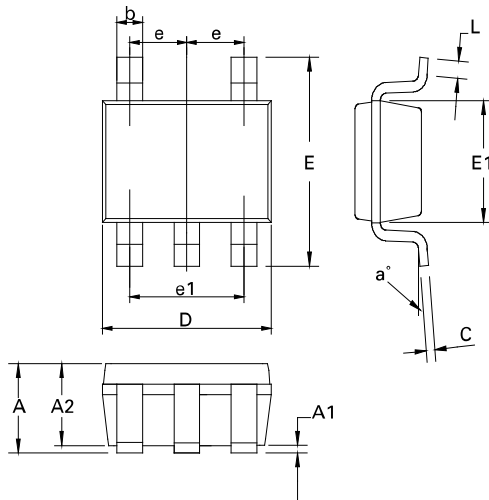

Dim.	Min.	Max.	Typ.
A	1.1	0.8	-
A1	0.1	-	-
A2	1	0.8	-
b	0.3	0.15	-
C	0.25	0.08	-
D	2.00 BSC		
E	2.10 BSC		
E1	1.25 BSC		
e	0.65 BSC		
e1	1.30 BSC		
L	0.46	0.26	-
a°	0	8	-

## Suggested Pad Layout

Please see <http://www.diodes.com/package-outlines.html> for the latest version.

### (1) Package Type: SOT23

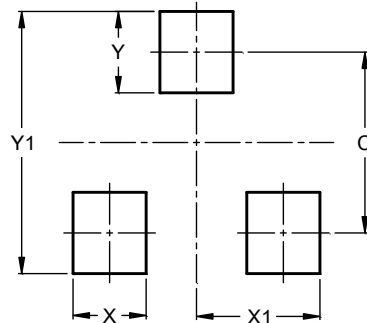

Dimensions	Value (in mm)
C	2.0
X	0.8
X1	1.35
Y	0.9
Y1	2.9

### IMPORTANT NOTICE

DIODES INCORPORATED MAKES NO WARRANTY OF ANY KIND, EXPRESS OR IMPLIED, WITH REGARDS TO THIS DOCUMENT, INCLUDING, BUT NOT LIMITED TO, THE IMPLIED WARRANTIES OF MERCHANTABILITY AND FITNESS FOR A PARTICULAR PURPOSE (AND THEIR EQUIVALENTS UNDER THE LAWS OF ANY JURISDICTION).

Diodes Incorporated and its subsidiaries reserve the right to make modifications, enhancements, improvements, corrections or other changes without further notice to this document and any product described herein. Diodes Incorporated does not assume any liability arising out of the application or use of this document or any product described herein; neither does Diodes Incorporated convey any license under its patent or trademark rights, nor the rights of others. Any Customer or user of this document or products described herein in such applications shall assume all risks of such use and will agree to hold Diodes Incorporated and all the companies whose products are represented on Diodes Incorporated website, harmless against all damages.

Diodes Incorporated does not warrant or accept any liability whatsoever in respect of any products purchased through unauthorized sales channel. Should Customers purchase or use Diodes Incorporated products for any unintended or unauthorized application, Customers shall indemnify and hold Diodes Incorporated and its representatives harmless against all claims, damages, expenses, and attorney fees arising out of, directly or indirectly, any claim of personal injury or death associated with such unintended or unauthorized application.

Products described herein may be covered by one or more United States, international or foreign patents pending. Product names and markings noted herein may also be covered by one or more United States, international or foreign trademarks.

This document is written in English but may be translated into multiple languages for reference. Only the English version of this document is the final and determinative format released by Diodes Incorporated.

### LIFE SUPPORT

Diodes Incorporated products are specifically not authorized for use as critical components in life support devices or systems without the express written approval of the Chief Executive Officer of Diodes Incorporated. As used herein:

A. Life support devices or systems are devices or systems which:

1. are intended to implant into the body, or
2. support or sustain life and whose failure to perform when properly used in accordance with instructions for use provided in the labeling can be reasonably expected to result in significant injury to the user.

B. A critical component is any component in a life support device or system whose failure to perform can be reasonably expected to cause the failure of the life support device or to affect its safety or effectiveness.

Customers represent that they have all necessary expertise in the safety and regulatory ramifications of their life support devices or systems, and acknowledge and agree that they are solely responsible for all legal, regulatory and safety-related requirements concerning their products and any use of Diodes Incorporated products in such safety-critical, life support devices or systems, notwithstanding any devices- or systems-related information or support that may be provided by Diodes Incorporated. Further, Customers must fully indemnify Diodes Incorporated and its representatives against any damages arising out of the use of Diodes Incorporated products in such safety-critical, life support devices or systems.

Copyright © 2017, Diodes Incorporated

[www.diodes.com](http://www.diodes.com)

## Looking for pricing, stock, or lifecycle information?

Click below to explore more details on WIN SOURCE:

 [View LM4040B50FTA on WIN SOURCE](#)

 [Diodes Incorporated](#) Information

## Optimize Your Supply Chain with WIN SOURCE Solutions

-  Global Sourcing Solution
-  Obsolete Management
-  Cost Control Management
-  Shortage Management
-  Alternative Solution
-  Excess Inventory Management