



**THE DATASHEET OF
LM4130AIM5X-4.1**



LM4130 Precision Micropower Low Dropout Voltage Reference

Check for Samples: [LM4130](#)

FEATURES

- Small SOT23-5 package
- High output voltage accuracy 0.05%
- Low Temperature Coefficient 10 ppm/°C
- Stable with capacitive loads to 100µF
- Low dropout voltage ≤ 275 mV @ 10 mA
- Supply Current ≤ 75 µA
- Full accuracy -40°C to 85°C
- Extended operation to 125°C
- Excellent load and line regulation
- Output current 20 mA
- Output impedance $< 1\Omega$
- Voltage options: 2.500V and 4.096V

APPLICATIONS SUMMARY

- Portable, battery powered equipment
- Instrumentation and process control
- Automotive & Industrial
- Test equipment
- Data acquisition systems
- Precision regulators
- Battery chargers
- Base stations
- Communications
- Medical equipment
- Servo systems

Connection Diagram and Pin Configuration

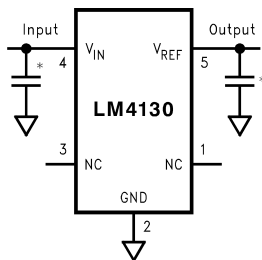

*Optional, Recommended for improved transient response and input noise reduction.
(See Application Information)

DESCRIPTION

The LM4130 family of precision voltage references performs comparable to the best laser-trimmed bipolar references, but in cost effective CMOS technology. Key to this break through is the use of EEPROM registers for correction of curvature, tempco, and accuracy on a CMOS bandgap architecture that allows package level programming to overcome assembly shift. The shifts in voltage accuracy and tempco during assembly of die into plastic packages limit the accuracy of references trimmed with laser techniques.

Unlike other LDO references, the LM4130 requires no output capacitor. Neither is a buffer amplifier required, even with loads up to 20mA. These advantages and the SOT23 packaging are important for cost-critical and space-critical applications.

Series references provide lower power consumption than shunt references, since they don't have to idle the maximum possible load current under no load conditions. This advantage, the low quiescent current (75µA), and the low dropout voltage(275mV) make the LM4130 ideal for battery-powered solutions.

The LM4130 is available in five grades (A, B, C, D and E) for greater flexibility. The best grade devices (A) have an initial accuracy of 0.05% with ensured temperature coefficient of 10ppm/°C or less, while the lowest grade parts (E) have an initial accuracy of 0.5% and a tempco of 30ppm/°C.



Please be aware that an important notice concerning availability, standard warranty, and use in critical applications of Texas Instruments semiconductor products and disclaimers thereto appears at the end of this data sheet.

All trademarks are the property of their respective owners.

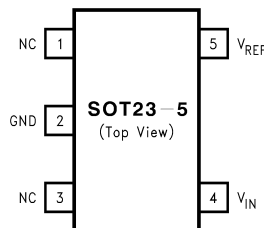

Refer to the Ordering Information Table in this Data Sheet for Specific Part Number

Figure 1. SOT23-5 Surface Mount Package

Table 1. SOT23-5 Package Marking Information Only four fields of marking are possible on the SOT23-5's small surface. This table gives the meaning of the four fields.

Field Information
First Field:
R = Reference
Second and Third Field:
03 = 2.50V Voltage Option
04 = 4.096V Voltage Option
Fourth Field:
A-E = Initial Reference Voltage Tolerance and Temperature Coefficient
A = $\pm 0.05\%$, 10ppm/ $^{\circ}\text{C}$
B = $\pm 0.2\%$, 10ppm/ $^{\circ}\text{C}$
C = $\pm 0.1\%$, 20ppm/ $^{\circ}\text{C}$
D = $\pm 0.4\%$, 20ppm/ $^{\circ}\text{C}$
E = $\pm 0.5\%$, 30ppm/ $^{\circ}\text{C}$



These devices have limited built-in ESD protection. The leads should be shorted together or the device placed in conductive foam during storage or handling to prevent electrostatic damage to the MOS gates.

Absolute Maximum Ratings ⁽¹⁾

Maximum Voltage on any Input	-0.3V to 6V
Output Short-Circuit Duration	Indefinite
Power Dissipation ($T_A = 25^{\circ}\text{C}$)	350 mW
⁽²⁾	
ESD Susceptibility ⁽³⁾	
Human Body Model	2 kV
Machine Model	200V
Lead Temperature:	
Soldering, (10 sec.)	+260 $^{\circ}\text{C}$
Vapor Phase (60 sec.)	+215 $^{\circ}\text{C}$
Infrared (15 sec.)	+220 $^{\circ}\text{C}$

- (1) Absolute Maximum Ratings indicate limits beyond which damage to the device may occur. Operating Ratings indicate conditions for which the device is intended to be functional, but do not ensure specific performance limits. For ensured specifications and test conditions, see Electrical Characteristics. The ensured specifications apply only for the test conditions listed. Some performance characteristics may degrade when the device is not operated under the listed test conditions.
- (2) Without PCB copper enhancements. The maximum power dissipation must be de-rated at elevated temperatures and is limited by T_{JMAX} (maximum junction temperature), θ_{J-A} (junction to ambient thermal resistance) and T_A (ambient temperature). The maximum power dissipation at any temperature is: $P_{DissMAX} = (T_{JMAX} - T_A)/\theta_{J-A}$ up to the value listed in the Absolute Maximum Ratings. θ_{J-A} for SOT23-5 package is 220 $^{\circ}\text{C}/\text{W}$, $T_{JMAX} = 125^{\circ}\text{C}$.
- (3) The human body model is a 100 pF capacitor discharged through a 1.5 k Ω resistor into each pin. The machine model is a 200 pF capacitor discharged directly into each pin.

Operating Range ⁽¹⁾

Storage Temperature Range	-65°C to +150°C
Operating Temperature Range	-40°C to +85°C

- (1) Absolute Maximum Ratings indicate limits beyond which damage to the device may occur. Operating Ratings indicate conditions for which the device is intended to be functional, but do not ensure specific performance limits. For ensured specifications and test conditions, see Electrical Characteristics. The ensured specifications apply only for the test conditions listed. Some performance characteristics may degrade when the device is not operated under the listed test conditions.

LM4130-2.500

Electrical Characteristics

Unless otherwise specified $V_{CC} = 5V$, $I_{LOAD} = 0$ $T_A = 25^\circ C$. Limits with standard typeface are for $T_A = 25^\circ C$, and limits in **boldface type** apply over the operating temperature range.

Symbol	Parameter	Conditions	Min (1)	Typ (2)	Max (1)	Units
V_{REF}	Output Voltage Initial Accuracy LM4130A-2.500 LM4130B-2.500 LM4130C-2.500 LM4130D-2.500 LM4130E-2.500				± 0.05 ± 0.2 ± 0.1 ± 0.4 ± 0.5	%
$TCV_{REF}/^\circ C$ (3)	Temperature Coefficient					ppm/ $^\circ C$
	LM4130A, B	$0^\circ C \leq T_A \leq +85^\circ C$ $-40^\circ C \leq T_A \leq +85^\circ C$			10 20	
	LM4130C, D				20	
	LM4130E				30	
$\Delta V_{REF}/\Delta V_{IN}$	Line Regulation	$I_{LOAD} = 100\mu A$				ppm/V
		$V_{REF} + 200\text{ mV} \leq V_{IN} \leq 5.5V$		30	100	
		$V_{REF} + 400\text{ mV} \leq V_{IN} \leq 5.5V$			150	
$\Delta V_{REF}/\Delta I_{LOAD}$	Load Regulation	$0\text{ mA} \leq I_{LOAD} \leq 20\text{ mA}$		25	60 80	ppm/mA
ΔV_{REF}	Long-Term Stability (4)	1000 Hrs		50		ppm
	Thermal Hysteresis (5)	$-40^\circ C \leq T_A \leq +125^\circ C$		50		
$V_{IN} - V_{REF}$	Dropout Voltage (6)	$I_{LOAD} = 10\text{ mA}$			275 400	mV
V_N	Output Noise Voltage	0.1 Hz to 10 Hz		150		μV_{PP}
I_S	Supply Current			50	75 90	μA
I_{SC}	Short Circuit Current		30		60	mA
					65	mA

- (1) Limits are 100% production tested at $25^\circ C$. Limits over the operating temperature range are ensured through correlation using Statistical Quality Control (SQC) methods. The limits are used to calculate TI's Average Outgoing Quality Level (AOQL).
- (2) Typical numbers are at $25^\circ C$ and represent the most likely parametric norm.
- (3) Temperature coefficient is measured by the "Box" method; i.e., the maximum ΔV_{REF} is divided by the maximum ΔT .
- (4) Long term stability is V_{REF} @ $25^\circ C$ measured during 1000 hrs.
- (5) Thermal hysteresis is defined as the change in $+25^\circ C$ output voltage before and after cycling the device from $-40^\circ C$ to $125^\circ C$.
- (6) Dropout voltage is defined as the minimum input to output differential at which the output voltage drops by 0.5% below the value measured with a 5V input.

LM4130-4.096 Electrical Characteristics

Unless otherwise specified $V_{CC} = 5.0V$, $I_{LOAD} = 0$ $T_A = 25^\circ C$. Limits with standard typeface are for $T_A = 25^\circ C$, and limits in **boldface type** apply over the operating temperature range.

Symbol	Parameter	Conditions	Min (1)	Typ (2)	Max (1)	Units
V_{REF}	Output Voltage Initial Accuracy LM4130-4.096A LM4130-4.096B LM4130-4.096C LM4130-4.096D LM4130-4.096E				± 0.05 ± 0.2 ± 0.1 ± 0.4 ± 0.5	%
$TCV_{REF}/^\circ C$ (3)	Temperature Coefficient					ppm/ $^\circ C$
	LM4130A, B	$0^\circ C \leq T_A \leq +85^\circ C$ $-40^\circ C \leq T_A \leq +85^\circ C$			10 20	
	LM4130C, D				20	
	LM4130E				30	
$\Delta V_{REF}/\Delta V_{IN}$	Line Regulation	$I_{LOAD} = 100\mu A$				ppm/V
		$V_{REF} + 500\text{ mV} \leq V_{IN} \leq 5.5V$		75	250 400	
$\Delta V_{REF}/\Delta I_{LOAD}$	Load Regulation	$0\text{ mA} \leq I_{LOAD} \leq 20\text{ mA}$		16	60 80	ppm/mA
ΔV_{REF}	Long-Term Stability (4)	1000 Hrs		50		ppm
	Thermal Hysteresis (5)	$-40^\circ C \leq T_A \leq +125^\circ C$		50		
$V_{IN} - V_{REF}$	Dropout Voltage (6)	$I_{LOAD} = 10\text{ mA}$			275 500	mV
V_N	Output Noise Voltage	0.1 Hz to 10 Hz		245		μV_{PP}
I_S	Supply Current			50	75 90	μA
I_{SC}	Short Circuit Current		30		60	mA
					65	mA

- (1) Limits are 100% production tested at $25^\circ C$. Limits over the operating temperature range are ensured through correlation using Statistical Quality Control (SQC) methods. The limits are used to calculate TI's Average Outgoing Quality Level (AOQL).
- (2) Typical numbers are at $25^\circ C$ and represent the most likely parametric norm.
- (3) Temperature coefficient is measured by the "Box" method; i.e., the maximum ΔV_{REF} is divided by the maximum ΔT .
- (4) Long term stability is V_{REF} @ $25^\circ C$ measured during 1000 hrs.
- (5) Thermal hysteresis is defined as the change in $+25^\circ C$ output voltage before and after cycling the device from $-40^\circ C$ to $125^\circ C$.
- (6) Dropout voltage is defined as the minimum input to output differential at which the output voltage drops by 0.5% below the value measured with a 5V input.

LM4130 Typical Performance Characteristics

$T_A = 25^\circ\text{C}$, No Load, $V_{IN} = 5.0\text{V}$, unless otherwise noted.

Temperature Drift Characteristics

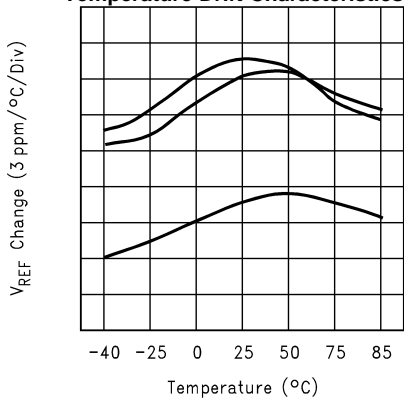

Load Regulation vs Temperature

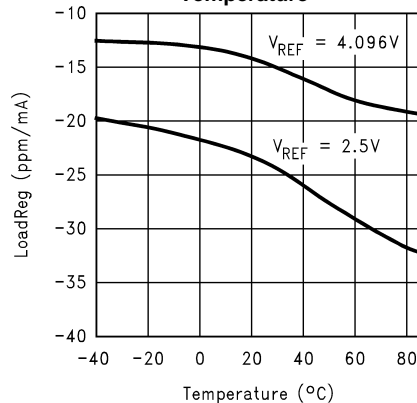

Line Regulation vs Load

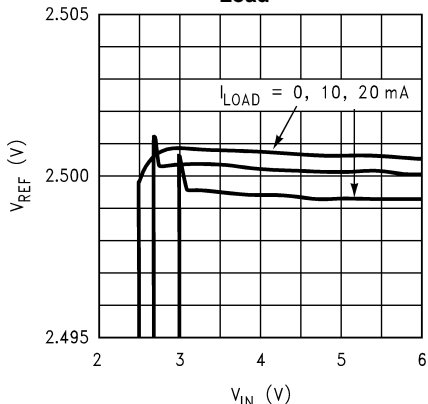

Line Regulation vs Temperature

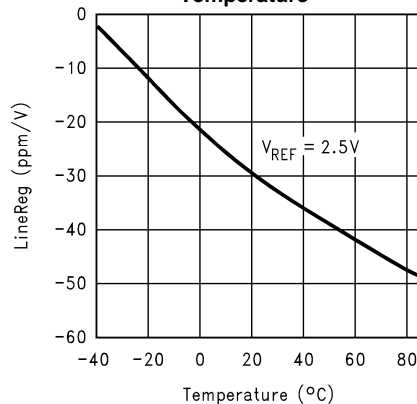

Output Voltage vs Load Current

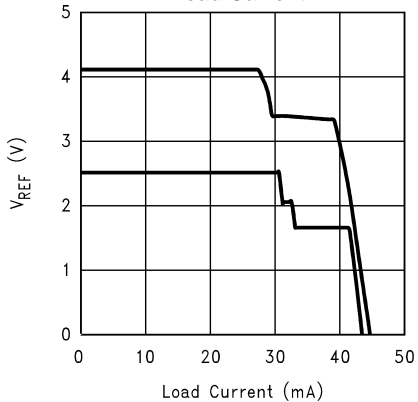

Dropout vs Load ($V_{REF} = 2.5$)

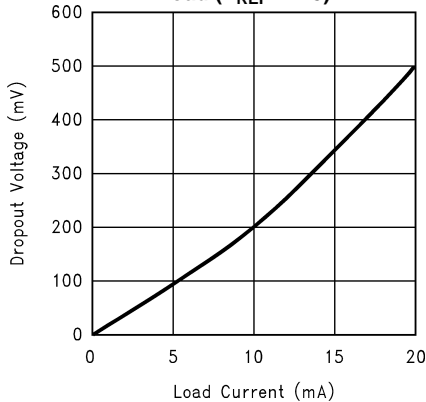

LM4130 Typical Performance Characteristics (continued)

$T_A = 25^\circ\text{C}$, No Load, $V_{IN} = 5.0\text{V}$, unless otherwise noted.

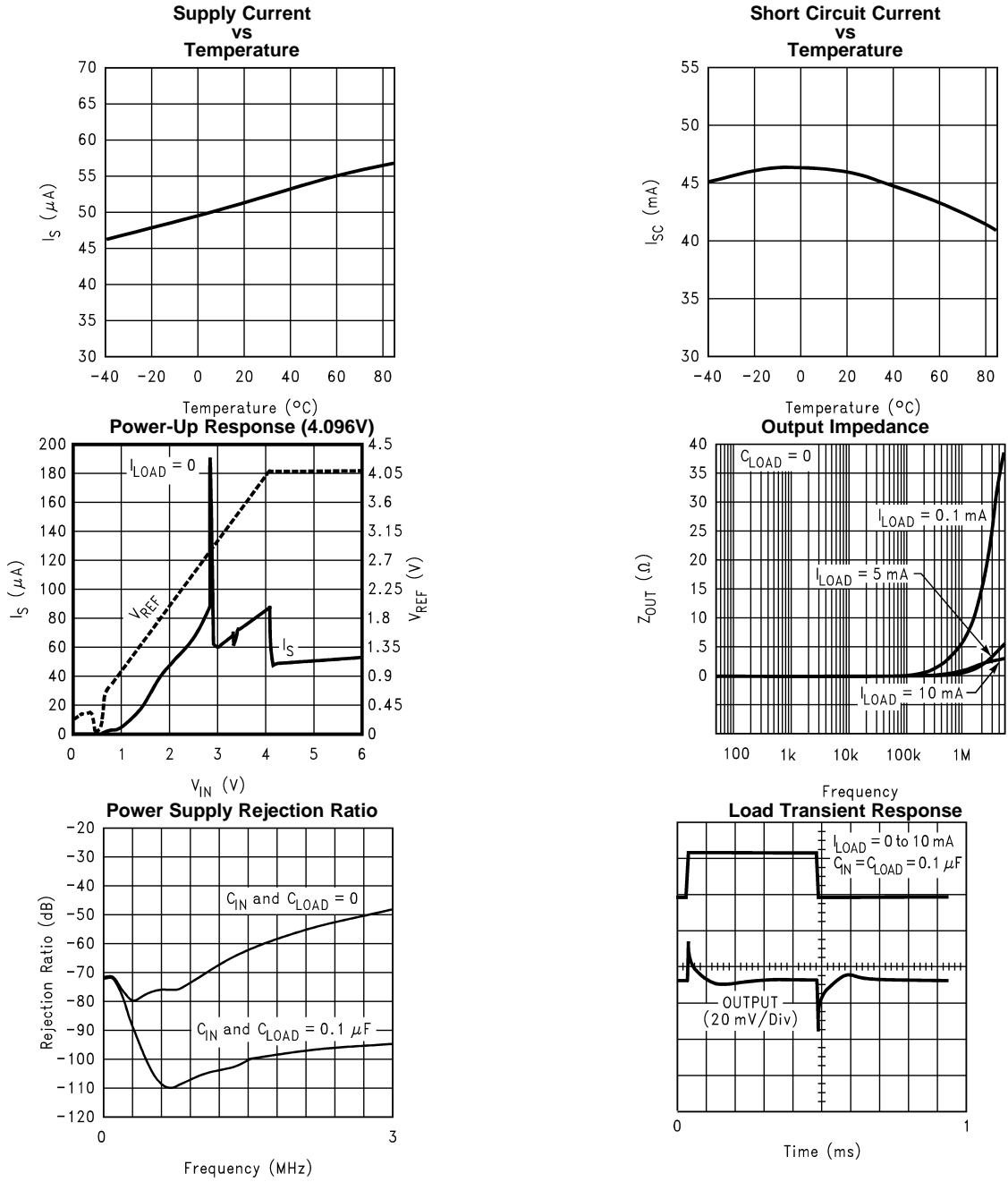

LM4130 Typical Performance Characteristics (continued)

$T_A = 25^\circ\text{C}$, No Load, $V_{IN} = 5.0\text{V}$, unless otherwise noted.

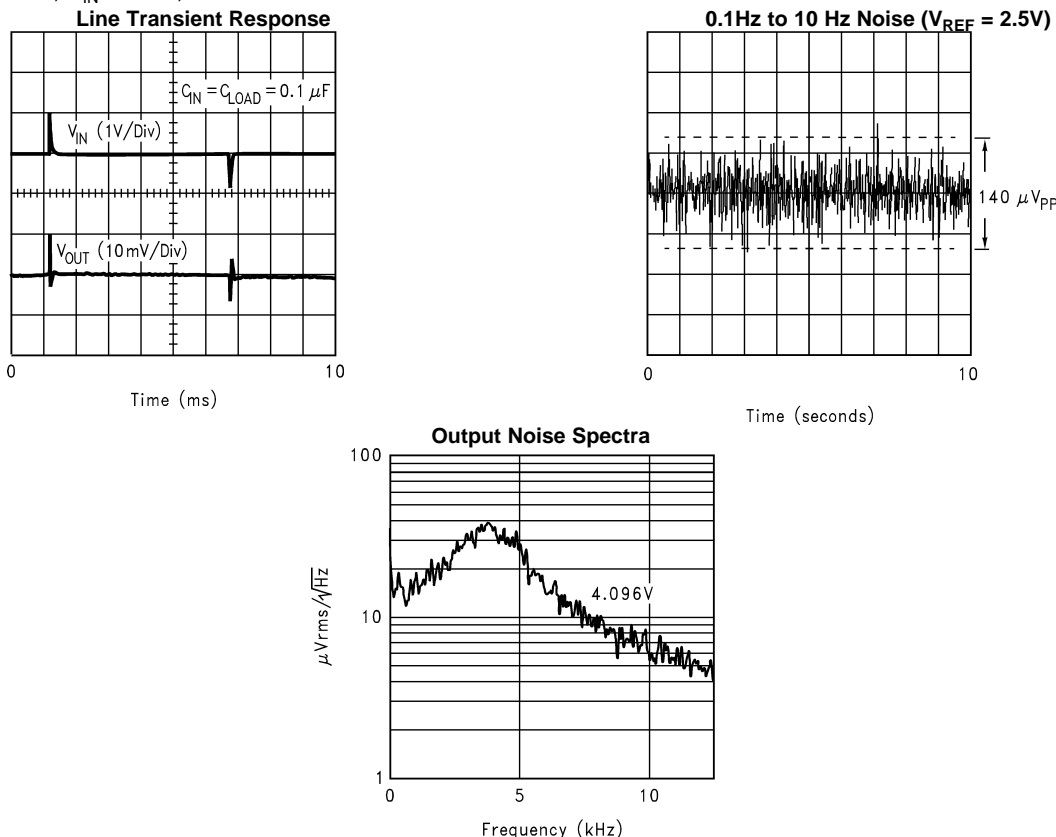

Pin Functions

V_{REF} (Pin 5): Reference Output. The output of the LM4130 can source up to 20 mA. It is stable with output capacitor ranges from 0 to 100 μF .

V_{IN} (Pin 4): Positive Supply. Bypassing with a 0.1 μF capacitor is recommended if the output loading changes or input is noisy.

Ground (Pin 2): Negative Supply or Ground Connection.

NC (Pins 1, 3): No Connection (internally terminated). These pins must be left unconnected.

Application Information

OUTPUT CAPACITOR

The LM4130 is designed to operate with or without an output capacitor and is stable with capacitive loads of up to 100 μF .

Connecting a capacitor between the output and ground will significantly improve the load transient response when switching from a light load to a heavy load. However, the output capacitor should not be made arbitrarily large because it will effect the turn-on time as well as line and load transients.

INPUT CAPACITOR

A small 0.1 μF capacitor on the input significantly improves stability under a wide range of load conditions. With an input bypass capacitor, the LM4130 will drive any combination of resistance and capacitance up to $V_{REF}/20\text{mA}$ and 100 μF respectively.

Noise on the power-supply input can effect the output noise, but it can be reduced by using an optional bypass capacitor between the input pin and the ground.

PRINTED CIRCUIT BOARD LAYOUT CONSIDERATION

References in SOT packages are generally less prone to assembly stress than devices in Small Outline (SOIC) package.

To minimize the mechanical stress due to PC board mounting that can cause the output voltage to shift from its initial value, mount the reference on a low flex area of the PC board, such as near the edge or a corner.

Typical Application Circuits

Figure 2. Precision High Current Low Dropout Regulator

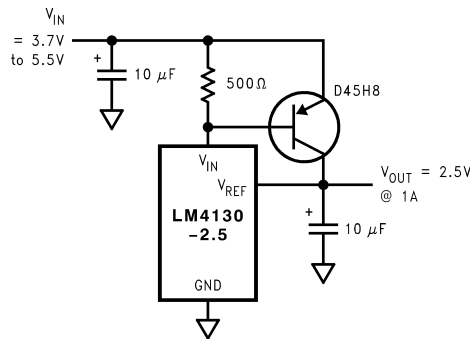

Figure 3. Voltage Reference with Complimentary Output

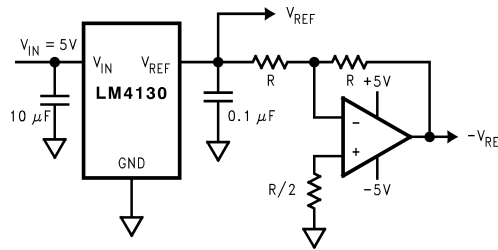

Figure 4. Precision High Current Low Dropout Regulator

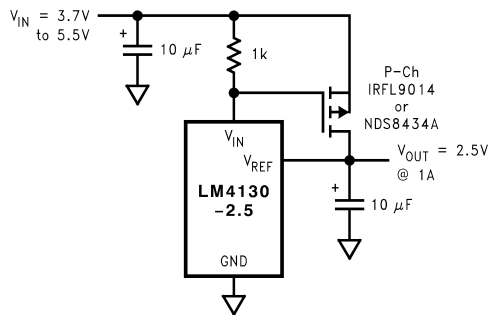

Figure 5. Precision Voltage Reference with Force and Sense Output

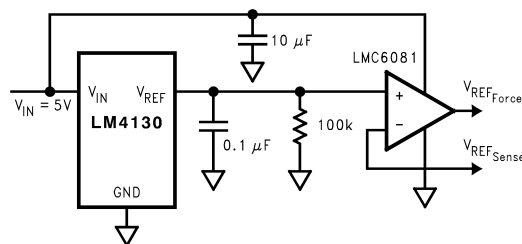
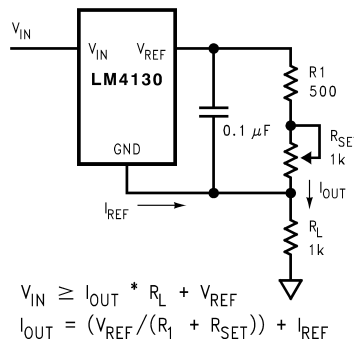
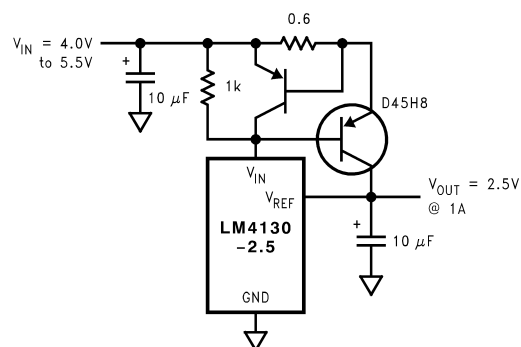
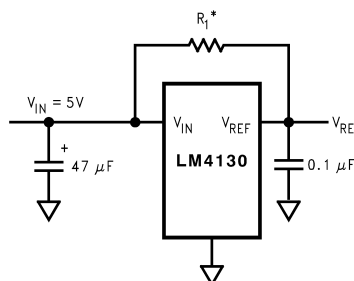
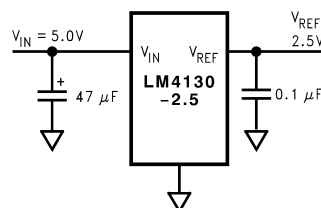

Figure 6. Programmable Current Source**Figure 7. Precision Regulator with Current Limiting Circuit****Figure 8. Low Cost Higher Output Current Circuit**

* Select R_1 to deliver 80% of typical load current. The LM4130 then will source as necessary, up to 20mA, to maintain the output regulation. Care must be taken not to remove the load as the output will be driven to the rail. This approach will effect line regulation.

Figure 9. Supply Splitter

REVISION HISTORY

Changes from Revision C (April 2013) to Revision D	Page
• Changed layout of National Data Sheet to TI format	10

IMPORTANT NOTICE

Texas Instruments Incorporated and its subsidiaries (TI) reserve the right to make corrections, enhancements, improvements and other changes to its semiconductor products and services per JESD46, latest issue, and to discontinue any product or service per JESD48, latest issue. Buyers should obtain the latest relevant information before placing orders and should verify that such information is current and complete. All semiconductor products (also referred to herein as "components") are sold subject to TI's terms and conditions of sale supplied at the time of order acknowledgment.

TI warrants performance of its components to the specifications applicable at the time of sale, in accordance with the warranty in TI's terms and conditions of sale of semiconductor products. Testing and other quality control techniques are used to the extent TI deems necessary to support this warranty. Except where mandated by applicable law, testing of all parameters of each component is not necessarily performed.

TI assumes no liability for applications assistance or the design of Buyers' products. Buyers are responsible for their products and applications using TI components. To minimize the risks associated with Buyers' products and applications, Buyers should provide adequate design and operating safeguards.

TI does not warrant or represent that any license, either express or implied, is granted under any patent right, copyright, mask work right, or other intellectual property right relating to any combination, machine, or process in which TI components or services are used. Information published by TI regarding third-party products or services does not constitute a license to use such products or services or a warranty or endorsement thereof. Use of such information may require a license from a third party under the patents or other intellectual property of the third party, or a license from TI under the patents or other intellectual property of TI.

Reproduction of significant portions of TI information in TI data books or data sheets is permissible only if reproduction is without alteration and is accompanied by all associated warranties, conditions, limitations, and notices. TI is not responsible or liable for such altered documentation. Information of third parties may be subject to additional restrictions.

Resale of TI components or services with statements different from or beyond the parameters stated by TI for that component or service voids all express and any implied warranties for the associated TI component or service and is an unfair and deceptive business practice. TI is not responsible or liable for any such statements.

Buyer acknowledges and agrees that it is solely responsible for compliance with all legal, regulatory and safety-related requirements concerning its products, and any use of TI components in its applications, notwithstanding any applications-related information or support that may be provided by TI. Buyer represents and agrees that it has all the necessary expertise to create and implement safeguards which anticipate dangerous consequences of failures, monitor failures and their consequences, lessen the likelihood of failures that might cause harm and take appropriate remedial actions. Buyer will fully indemnify TI and its representatives against any damages arising out of the use of any TI components in safety-critical applications.

In some cases, TI components may be promoted specifically to facilitate safety-related applications. With such components, TI's goal is to help enable customers to design and create their own end-product solutions that meet applicable functional safety standards and requirements. Nonetheless, such components are subject to these terms.

No TI components are authorized for use in FDA Class III (or similar life-critical medical equipment) unless authorized officers of the parties have executed a special agreement specifically governing such use.

Only those TI components which TI has specifically designated as military grade or "enhanced plastic" are designed and intended for use in military/aerospace applications or environments. Buyer acknowledges and agrees that any military or aerospace use of TI components which have **not** been so designated is solely at the Buyer's risk, and that Buyer is solely responsible for compliance with all legal and regulatory requirements in connection with such use.

TI has specifically designated certain components as meeting ISO/TS16949 requirements, mainly for automotive use. In any case of use of non-designated products, TI will not be responsible for any failure to meet ISO/TS16949.

Products

Audio	www.ti.com/audio
Amplifiers	amplifier.ti.com
Data Converters	dataconverter.ti.com
DLP® Products	www.dlp.com
DSP	dsp.ti.com
Clocks and Timers	www.ti.com/clocks
Interface	interface.ti.com
Logic	logic.ti.com
Power Mgmt	power.ti.com
Microcontrollers	microcontroller.ti.com
RFID	www.ti-rfid.com
OMAP Applications Processors	www.ti.com/omap
Wireless Connectivity	www.ti.com/wirelessconnectivity

Applications

Automotive and Transportation	www.ti.com/automotive
Communications and Telecom	www.ti.com/communications
Computers and Peripherals	www.ti.com/computers
Consumer Electronics	www.ti.com/consumer-apps
Energy and Lighting	www.ti.com/energy
Industrial	www.ti.com/industrial
Medical	www.ti.com/medical
Security	www.ti.com/security
Space, Avionics and Defense	www.ti.com/space-avionics-defense
Video and Imaging	www.ti.com/video

TI E2E Community

e2e.ti.com

Looking for pricing, stock, or lifecycle information?

Click below to explore more details on WIN SOURCE:

 [View LM4130AIM5X-4.1 on WIN SOURCE](#)

 [Texas Instruments](#) Information

Optimize Your Supply Chain with WIN SOURCE Solutions

-  Global Sourcing Solution
-  Obsolete Management
-  Cost Control Management
-  Shortage Management
-  Alternative Solution
-  Excess Inventory Management