

# Power Transistor (−40V, −2A)

2SB1183 / 2SB1239 / 2SB786F

●Features

- 1) Darlington connection for high DC current gain.
- 2) Built-in 4 kΩ resistor between base and emitter.
- 3) Complements the 2SD1759/2SD1861/2SD947F.

●Circuit schematic

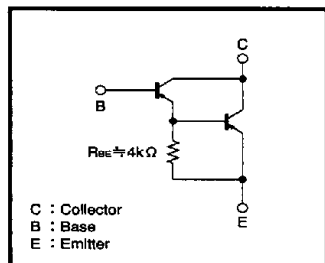

●Absolute maximum ratings (Ta=25°C)

Parameter	Symbol	Limits	Unit
Collector-base voltage	V <sub>CB0</sub>	−40	V
Collector-emitter voltage	V <sub>CE0</sub>	−40	V
Emitter-base voltage	V <sub>EB0</sub>	−5	V
Collector current	I <sub>c</sub>	−2	A (DC)
		−3	A (Pulse) *1
Collector power dissipation	P <sub>c</sub>	1	W
		10	W (T <sub>c</sub> =25°C)
		1	W *2
		1.2	W
		5	W (T <sub>c</sub> =25°C)
Junction temperature	T <sub>j</sub>	150	°C
Storage temperature	T <sub>stg</sub>	−55~150	°C

\*1 Single pulse P<sub>w</sub>=10ms \*2 Printed circuit board 1.7mm thick, collector plating 1cm<sup>2</sup> or larger.

●Packaging specifications and h<sub>FE</sub>

Type	2SB1183	2SB1239	2SB786F
Package	CPT3	ATV	TO-126FP
h <sub>FE</sub>	1k~200k	1k~	1k~
Code	TL	T148	—
Basic ordering unit (pieces)	2500	2500	1000

●Electrical characteristics (Ta=25°C)

Parameter	Symbol	Min.	Typ.	Max.	Unit	Conditions
Collector-base breakdown voltage	BV <sub>CB0</sub>	−40	—	—	V	I <sub>c</sub> =−50 μA
Collector-emitter breakdown voltage	BV <sub>CE0</sub>	−40	—	—	V	I <sub>c</sub> =−1mA, R <sub>BE</sub> =10kΩ
Emitter-base breakdown voltage	BV <sub>EB0</sub>	−5	—	—	V	I <sub>E</sub> =−50 μA
Collector cutoff current	I <sub>CB0</sub>	—	—	−1	μA	V <sub>CB</sub> =−24V
Emitter cutoff current	I <sub>EB0</sub>	—	—	−1	μA	V <sub>EB</sub> =−4V
Collector-emitter saturation voltage	V <sub>CE(sat)</sub>	—	—	−1.5	V	I <sub>c</sub> /I <sub>B</sub> =−0.6A/−1.2mA
DC current transfer ratio	h <sub>FE</sub>	1000	—	20000	—	V <sub>CE</sub> /I <sub>c</sub> =−2V/−0.5A
		1000	—	—	—	
Output capacitance	C <sub>ob</sub>	—	11	—	pF	V <sub>CB</sub> =−10V, I <sub>E</sub> =0A, f=1MHz

(96-126-B23)

# Power Transistor (40V, 2A)

2SD1759 / 2SD1861 / 2SD947F

●Features

- 1) Darlington connection for high DC current gain.
- 2) Built-in 4kΩ resistor between base and emitter.
- 3) Complements the 2SB1183/2SB1239/2SB786F.

●Circuit schematic

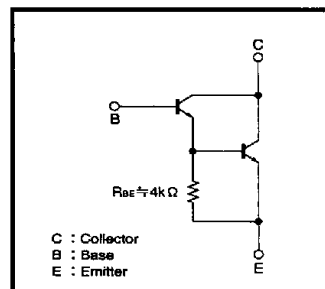

●Absolute maximum ratings (Ta=25°C)

Parameter	Symbol	Limits	Unit
Collector-base voltage	V <sub>CB0</sub>	40	V
Collector-emitter voltage	V <sub>CE0</sub>	40	V (R <sub>BE</sub> =10kΩ)
Emitter-base voltage	V <sub>EB0</sub>	5	V
Collector current	I <sub>c</sub>	2	A (DC)
		3	A (Pulse) *1
Collector power dissipation	P <sub>c</sub>	1	W *2
		1	W
		10	W (T <sub>c</sub> =25°C)
		1.2	W
		5	W (T <sub>c</sub> =25°C)
Junction temperature	T <sub>j</sub>	150	°C
Storage temperature	T <sub>stg</sub>	−55~150	°C

\*1 Single pulse P<sub>w</sub>=10ms \*2 Printed circuit board 1.7mm thick, collector plating 1cm<sup>2</sup> or larger.

●Packaging specifications and h<sub>FE</sub>

Type	2SD1759	2SD1861	2SD947F
Package	CPT3	ATV	TO-126FP
h <sub>FE</sub>	1k~200k	1k~	1k~
Code	TL	TV2	—
Basic ordering unit (pieces)	2500	2500	1000

●Electrical characteristics (Ta=25°C)

Parameter	Symbol	Min.	Typ.	Max.	Unit	Conditions
Collector-base breakdown voltage	BV <sub>CB0</sub>	40	—	—	V	I <sub>c</sub> =50 μA
Collector-emitter breakdown voltage	BV <sub>CE0</sub>	40	—	—	V	I <sub>c</sub> =1mA, R <sub>BE</sub> =10kΩ
Emitter-base breakdown voltage	BV <sub>EB0</sub>	5	—	—	V	I <sub>E</sub> =50 μA
Collector cutoff current	I <sub>CB0</sub>	—	—	1	μA	V <sub>CB</sub> =24V
Emitter cutoff current	I <sub>EB0</sub>	—	—	1	μA	V <sub>EB</sub> =4V
Collector-emitter saturation voltage	V <sub>CE(sat)</sub>	—	—	1.5	V	I <sub>c</sub> /I <sub>B</sub> =0.6mA/1.2mA
DC current transfer ratio	h <sub>FE</sub>	1000	—	20000	—	V <sub>CE</sub> /I <sub>c</sub> =3V/0.5A
		1000	—	—	—	
Output capacitance	C <sub>ob</sub>	—	11	—	pF	V <sub>CB</sub> =10V, I <sub>E</sub> =0A, f=1MHz

# Packages

ROHM has been manufacturing transistors since 1975. In the development of products, we constantly strive to anticipate the needs of our customers. Regarding packages, the demands of the market for compactness, low power consumption, low power dissipation and automatic mounting support are becoming ever greater, and we are strengthening our product development system to meet these needs.

●Types and features of surface-mount packages

Type	External dimensions (Units : mm)	Features
<p>EMT3 SC-75A type</p>		<p>A more compact version of the UMT3 (SC-70), the EMT3 is the world's smallest transistor with a mold size of 1.6 × 0.8 mm. The mounting area is approximately 60% of the UMT3 and 30% of the SMT3, making it ideal for ultra-high density mounting. Mounting is possible with the same type of automatic mounting machine as the UMT3.</p>
<p>UMT3 SC-70 type</p>		<p>The UMT3 is a smaller version of the SMT3 (SC-59). The mounting area is approximately 60% of the SMT3, making it optimum for high density mounting. The taping size is the same as the SMT3, allowing use of conventional automatic mounting machines. Electrical characteristics and reliability are the same as the SMT3.</p>
<p>SMT3 SC-59 type</p>		<p>The SMT3 is a compact package suitable for small electronic devices and hybrid IC applications. With proven performance, this is one of the most basic small packages. With the exception of <math>P_c</math> (collector power dissipation), electrical characteristics are similar to leaded packages. Reliability is on the same level as the TO-92.</p>
<p>MPT3 SC-62 type</p>		<p>By itself the MPT3 has a <math>P_c</math> of 0.5 W (<math>T_a = 25^\circ\text{C}</math>), but when used on a 40 × 40 × 0.7 mm ceramic board, <math>P_c = 2</math> W (<math>T_c = 25^\circ\text{C}</math>), allowing high power to be obtained with a small package. The flat package makes it suitable for applications requiring compactness such as hybrid ICs. Available on tape for automatic mounting.</p>

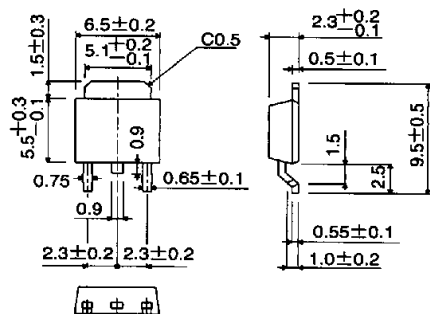
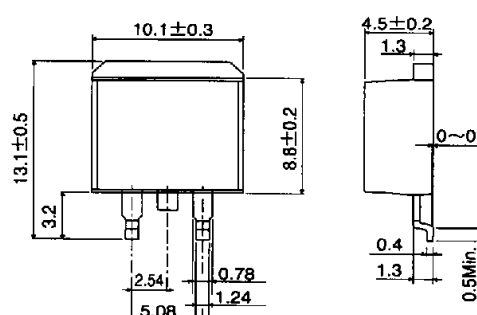
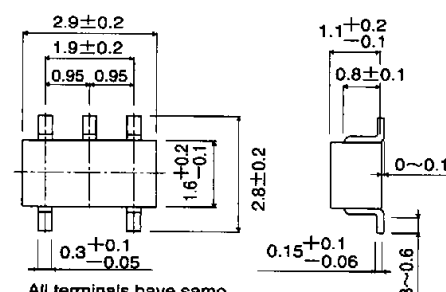
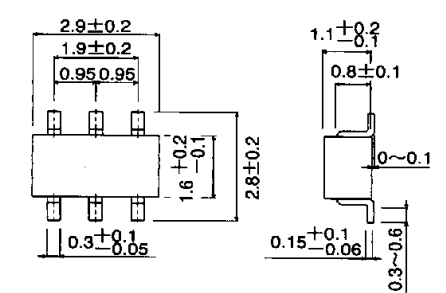
Type	External dimensions (Units : mm)	Features
<p>CPT 3 SC-63 type</p>	 <p>Technical drawing of CPT 3 SC-63 type transistor. Top view dimensions: 6.5±0.2, 5.1±0.2, 1.5±0.3, 0.9, 0.65±0.1, 2.3±0.2, 2.3±0.2. Side view dimensions: 2.3±0.2, 0.5±0.1, 1.5, 2.5, 9.5±0.5, 0.55±0.1, 1.0±0.2. Lead angle: C0.5.</p>	<p>By itself the CPT3 has a <math>P_c</math> of 1 W (<math>T_a = 25^\circ\text{C}</math>), but a large <math>P_c</math> of several watts can be obtained with an appropriate mounting surface. At the same time the CPT3 is compact, making it suitable for high density mounting and hybrid ICs. Available on tape for automatic mounting. For vertical high density mounting, the leaded CPT (SC-64) type with the same mold size is also available.</p>
<p>PSD3</p>	 <p>Technical drawing of PSD3 transistor. Top view dimensions: 10.1±0.3, 13.1±0.5, 8.6±0.2, 3.2, 2.54, 5.08, 0.78, 1.24. Side view dimensions: 4.5±0.2, 1.3, 0~0.3, 0.4, 1.3, 0.5Min.</p>	<p>The PSD3 is a TO-220 class surface-mount package. A high <math>P_c</math> can be obtained with an appropriate mounting surface. Surface mounting allows a high vertical density, enabling the design of slim and compact devices. The PSD3 is available on tape for automatic mounting, and it helps improve mounting efficiency and reduce mounting cost.</p>
<p>SMT5 SC-74A type</p>	 <p>Technical drawing of SMT5 SC-74A type transistor. Top view dimensions: 2.9±0.2, 1.9±0.2, 0.95, 0.95, 1.6±0.2, 2.8±0.2, 0.3±0.1, 0.05. Side view dimensions: 1.1±0.2, 0.1, 0.8±0.1, 0~0.1, 0.15±0.1, 0.06, 0.3~0.6.</p> <p>All terminals have same dimensions</p>	<p>The SMT5 consists of two connected transistors or digital transistors in an SMT3 (SC-59) package. The mounting area can be reduced by 50% compared to the SMT3 and the internal circuitry is complete, making this package ideal for high density mounting at half the assembly cost.</p>
<p>SMT6 SC-74 type</p>	 <p>Technical drawing of SMT6 SC-74 type transistor. Top view dimensions: 2.9±0.2, 1.9±0.2, 0.95, 0.95, 1.6±0.2, 2.8±0.2, 0.3±0.1, 0.05. Side view dimensions: 1.1±0.2, 0.1, 0.8±0.1, 0~0.1, 0.15±0.1, 0.06, 0.3~0.6.</p>	<p>The SMT6 consists of two independent transistors or two independent digital transistors in an SMT3 (SC-59) package. The mounting area and mounting cost can be reduced by 50% compared to the SMT3, and the two transistors are independent to allow free configuration of a high density circuit.</p>

EXPLANATION

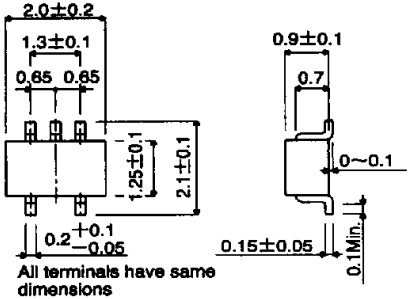
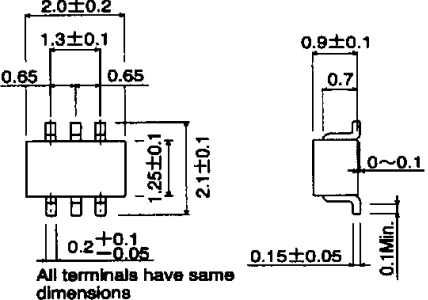
Type	External dimensions (Units : mm)	Features
<p>UMT5 SC-88A type</p>	 <p>All terminals have same dimensions</p>	<p>The UMT5 consists of two connected transistors or digital transistors in a UMT3 (SC-70) package. The mounting area can be reduced by 50% compared to the UMT3 and the internal circuitry is completed, making this package ideal for high density mounting at half the assembly cost.</p>
<p>UMT6 SC-88 type</p>	 <p>All terminals have same dimensions</p>	<p>The UMT6 consists of two independent transistors or two independent digital transistors in a UMT (SC-70) package. The mounting area and mounting cost can be reduced by 50% compared to the UMT3, and the two transistors are independent to allow free configuration of a high density circuit.</p>

●Types and features of leaded packages

Type	External dimensions (Units : mm)	Features
<p>SPT (SC-72 type)</p>		<p>The SPT is a smaller version of the conventional TO-92 type. The body size (3X4X2 mm<sup>3</sup>) has been reduced to 1/4 that of the TO-92 (5X5X4 mm<sup>3</sup>). The SPT is available on tape for automatic insertion, and less space is occupied on the printed circuit board than the TO-92. Reliability is the same as the TO-92.</p>
<p>FTR</p>		<p>SIL type with a height of 3.4 mm and a lead pitch of 2.54 mm.</p>
<p>FTL</p>		<p>The FTL is a radial taping version of the highly popular FTR. This enables automatic high-density mounting with a radial insertion machine.</p>
<p>ATR (SC-71 type)</p>		<p>SC-71type with a height of 4.4 mm and a P<sub>c</sub>=1W type.</p>

EXPLANATION

Type	External dimensions (Units : mm)	Features
ATV		<p>The ATV is a radial tapering version of the highly popular ATR. This enables automatic high-density mounting with a radial insertion machine.</p>
TO-92 (SC-43 type)		<p>The SC-43 is for general purpose small signals.</p>
TO-126FP		<p>The TO-126FP is an isolation type package based on a TO-126 full mold. In addition to the features of the TO-126, molded heat sink fins allow easy isolation of the heat sink.</p>
TO-220FP (SC-67 type)		<p>The TO-220FP is an isolation type package based on a TO-220 full mold. In addition to the features of the TO-126 and TO-220, molded heat sink fins allow easy isolation of the heat sink.</p>

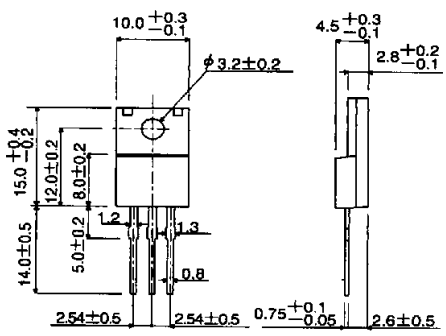
Type	External dimensions (Units : mm)	Features
TO-220FN	 <p>Technical drawing of the TO-220FN transistor package showing front and side views with dimensions in mm. The front view shows a total width of 10.0 ± 0.3 mm and a diameter of 3.2 ± 0.2 mm. The side view shows a total height of 14.0 ± 0.5 mm and a base thickness of 2.6 ± 0.5 mm. Other dimensions include 15.0 ± 0.4 mm, 12.0 ± 0.2 mm, 8.0 ± 0.2 mm, 5.0 ± 0.2 mm, 1.2 mm, 1.3 mm, 0.8 mm, 2.54 ± 0.5 mm, 0.75 ± 0.1 mm, 4.5 ± 0.3 mm, and 2.8 ± 0.2 mm.</p>	<p>The TO-220FN features the same performance as the TO-220FP with approximately 2 mm less height, allowing the design of slimmer devices. Furthermore, the elimination of support pins in the fin (collector electrode) solves short-circuiting problems with neighboring components and the chassis.</p> <p>To make the height to the installation hole the same as the TO-220FP, it can be replaced as is from the TO-220FP.</p>

EXPLANATION

## Looking for pricing, stock, or lifecycle information?

Click below to explore more details on WIN SOURCE:

- [View 2SB1183 on WIN SOURCE](#)
- [Rohm Semiconductor Information](#)

## Optimize Your Supply Chain with WIN SOURCE Solutions

- ✓ Global Sourcing Solution
- ✓ Obsolete Management
- ✓ Cost Control Management
- ✓ Shortage Management
- ✓ Alternative Solution
- ✓ Excess Inventory Management