



# THE DATASHEET OF LM614CWMX



# LM614

## Quad Operational Amplifier and Adjustable Reference

### General Description

The LM614 consists of four op-amps and a programmable voltage reference in a 16-pin package. The op-amp out-performs most single-supply op-amps by providing higher speed and bandwidth along with low supply current. This device was specifically designed to lower cost and board space requirements in transducer, test, measurement and data acquisition systems.

Combining a stable voltage reference with four wide output swing op-amps makes the LM614 ideal for single supply transducers, signal conditioning and bridge driving where large common-mode-signals are common. The voltage reference consists of a reliable band-gap design that maintains low dynamic output impedance ( $1\Omega$  typical), initial tolerance (2.0%), and the ability to be programmed from 1.2V to 5.0V via two external resistors. The voltage reference is very stable even when driving large capacitive loads, as are commonly encountered in CMOS data acquisition systems.

As a member of National's new Super-Block™ family, the LM614 is a space-saving monolithic alternative to a multichip solution, offering a high level of integration without sacrificing performance.

### Features

#### Op Amp

- Low operating current: 450 $\mu$ A
- Wide supply voltage range: 4V to 36V
- Wide common-mode range:  $V^-$  to  $(V^+ - 1.8V)$
- Wide differential input voltage:  $\pm 36V$

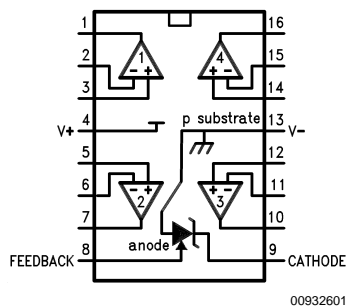
#### Reference

- Adjustable output voltage: 1.2V to 5.0V
- Initial tolerance:  $\pm 2.0\%$
- Wide operating current range: 17 $\mu$ A to 20mA
- Tolerant of load capacitance

### Applications

- Transducer bridge driver and signal processing
- Process and mass flow control systems
- Power supply voltage monitor
- Buffered voltage references for A/D's

### Connection Diagram



### Ordering Information

Package	Temperature Range	Part Number	Package Marking	Transport Media	NSC Drawing
16-Pin Wide Body SOIC	0°C to 70°C	LM614CWM	LM614CWM	Rails	M16B
		LM614CWMX	LM614CWM	1k Units Tape and Reel	
	-40°C to 85°C	LM614IWM	LM614IWM	Rails	
		LM614IWMX	LM614IWM	1k Units Tape and Reel	

Super-Block™ is a trademark of National Semiconductor Corporation.

**Absolute Maximum Ratings** (Note 1)

If Military/Aerospace specified devices are required, please contact the National Semiconductor Sales Office/Distributors for availability and specifications.

Voltage on Any Pins except  $V_R$   
(referred to  $V^-$  pin)

(Note 2) 36V (Max)  
(Note 3) -0.3V (Min)

Current through Any Input Pin &

$V_R$  Pin  $\pm 20$  mA

Differential Input Voltage

LM614I  $\pm 36$ V  
LM614C  $\pm 32$ V

Storage Temperature Range  $-65^\circ\text{C} \leq T_J \leq +150^\circ\text{C}$   
Maximum Junction Temperature 150°C  
Thermal Resistance,  
Junction-to-Ambient (Note 4) 150°C  
Soldering Information (Soldering,  
10 sec.) 220°C  
ESD Tolerance (Note 5)  $\pm 1$ kV

**Operating Temperature Range**

LM614I  $-40^\circ\text{C} \leq T_J \leq +85^\circ\text{C}$   
LM614C  $0^\circ\text{C} \leq T_J \leq +70^\circ\text{C}$

**Electrical Characteristics**

These specifications apply for  $V^- = \text{GND} = 0\text{V}$ ,  $V^+ = 5\text{V}$ ,  $V_{\text{CM}} = V_{\text{OUT}} = 2.5\text{V}$ ,  $I_R = 100\mu\text{A}$ , FEEDBACK pin shorted to GND, unless otherwise specified. Limits in standard typeface are for  $T_J = 25^\circ\text{C}$ ; limits in **Boldface type** apply over the **Operating Temperature Range**.

Symbol	Parameter	Conditions	Typ (Note 6)	LM614I LM614C Limits (Note 7)	Units
$I_S$	Total Supply Current	$R_{\text{LOAD}} = \infty$ , $4\text{V} \leq V^+ \leq 36\text{V}$ (32V for LM614C)	450	1000	$\mu\text{A}$ max
			<b>550</b>	<b>1070</b>	$\mu\text{A}$ max
$V_S$	Supply Voltage Range		2.2	2.8	V min
			<b>2.9</b>	<b>3</b>	V min
			46	32	V max
			<b>43</b>	<b>32</b>	V max
<b>OPERATIONAL AMPLIFIER</b>					
$V_{\text{OS1}}$	$V_{\text{OS}}$ Over Supply	$4\text{V} \leq V^+ \leq 36\text{V}$ ( $4\text{V} \leq V^+ \leq 32\text{V}$ for LM614C)	1.5	5.0	mV max
			<b>2.0</b>	<b>7.0</b>	mV max
$V_{\text{OS2}}$	$V_{\text{OS}}$ Over $V_{\text{CM}}$	$V_{\text{CM}} = 0\text{V}$ through $V_{\text{CM}} =$ ( $V^+ - 1.8\text{V}$ ), $V^+ = 30\text{V}$	1.0	5.0	mV max
			<b>1.5</b>	<b>7.0</b>	mV max
$\frac{V_{\text{OS3}}}{\Delta T}$	Average $V_{\text{OS}}$ Drift	(Note 7)	<b>15</b>		$\mu\text{V}/^\circ\text{C}$ max
$I_B$	Input Bias Current		10	35	nA max
			<b>11</b>	<b>40</b>	nA max
$I_{\text{OS}}$	Input Offset Current		0.2	4	nA max
			<b>0.3</b>	<b>5</b>	nA max
$\frac{I_{\text{OS1}}}{\Delta T}$	Average Offset Drift Current		<b>4</b>		$\text{pA}/^\circ\text{C}$
$R_{\text{IN}}$	Input Resistance	Differential	1800		$\text{M}\Omega$
		Common-Mode	3800		$\text{M}\Omega$
$C_{\text{IN}}$	Input Capacitance	Common-Mode Input	5.7		pF
$e_n$	Voltage Noise	$f = 100$ Hz, Input Referred	74		$\text{nV}/\sqrt{\text{Hz}}$
$I_n$	Current Noise	$f = 100$ Hz, Input Referred	58		$\text{fA}/\sqrt{\text{Hz}}$
CMRR	Common-Mode Rejection Ratio	$V^+ = 30\text{V}$ , $0\text{V} \leq V_{\text{CM}} \leq (V^+ - 1.8\text{V})$ , $\text{CMRR} = 20 \log (\Delta V_{\text{CM}}/\Delta V_{\text{OS}})$	95	75	dB min
			<b>90</b>	<b>70</b>	dB min
PSRR	Power Supply Rejection Ratio	$4\text{V} \leq V^+ \leq 30\text{V}$ , $V_{\text{CM}} = V^+/2$ , $\text{PSRR} = 20 \log (\Delta V^+/\Delta V_{\text{OS}})$	110	75	dB min
			<b>100</b>	<b>70</b>	dB min

## Electrical Characteristics (Continued)

These specifications apply for  $V^- = \text{GND} = 0\text{V}$ ,  $V^+ = 5\text{V}$ ,  $V_{\text{CM}} = V_{\text{OUT}} = 2.5\text{V}$ ,  $I_{\text{R}} = 100\mu\text{A}$ , FEEDBACK pin shorted to GND, unless otherwise specified. Limits in standard typeface are for  $T_{\text{J}} = 25^\circ\text{C}$ ; limits in **Boldface type** apply over the **Operating Temperature Range**.

Symbol	Parameter	Conditions	Typ (Note 6)	LM614 LM614C Limits (Note 7)	Units
$A_V$	Open Loop Voltage Gain	$R_L = 10\text{ k}\Omega$ to GND, $V^+ = 30\text{V}$ , $5\text{V} \leq V_{\text{OUT}} \leq 25\text{V}$	500 <b>50</b>	94 <b>40</b>	V/mV min
SR	Slew Rate	$V^+ = 30\text{V}$ (Note 8)	$\pm 0.70$ <b><math>\pm 0.65</math></b>	$\pm 0.50$ <b><math>\pm 0.45</math></b>	V/ $\mu\text{s}$
GBW	Gain Bandwidth	$C_L = 50\text{ pF}$	0.8 <b>0.52</b>		MHz MHz
$V_{\text{O1}}$	Output Voltage Swing High	$R_L = 10\text{ k}\Omega$ to GND $V^+ = 36\text{V}$ (32V for LM614C)	$V^+ - 1.4$ <b><math>V^+ - 1.6</math></b>	$V^+ - 1.8$ <b><math>V^+ - 1.9</math></b>	V min V min
$V_{\text{O2}}$	Output Voltage Swing Low	$R_L = 10\text{ k}\Omega$ to $V^+$ $V^+ = 36\text{V}$ (32V for LM614C)	$V^- + 0.8$ <b><math>V^- + 0.9</math></b>	$V^- + 0.95$ <b><math>V^- + 1.0</math></b>	V max V max
$I_{\text{OUT}}$	Output Source	$V_{\text{OUT}} = 2.5\text{V}$ , $V_{+\text{IN}} = 0\text{V}$ , $V_{-\text{IN}} = -0.3\text{V}$	25 <b>15</b>	16 <b>13</b>	mA min mA min
$I_{\text{SINK}}$	Output Sink Current	$V_{\text{OUT}} = 1.6\text{V}$ , $V_{+\text{IN}} = 0\text{V}$ , $V_{-\text{IN}} = 0.3\text{V}$	17 <b>9</b>	13 <b>8</b>	mA min mA min
$I_{\text{SHORT}}$	Short Circuit Current	$V_{\text{OUT}} = 0\text{V}$ , $V_{+\text{IN}} = 3\text{V}$ , $V_{-\text{IN}} = 2\text{V}$ , Source	30 <b>40</b>	50 <b>60</b>	mA max mA max
		$V_{\text{OUT}} = 5\text{V}$ , $V_{+\text{IN}} = 2\text{V}$ , $V_{-\text{IN}} = 3\text{V}$ , Sink	30 <b>32</b>	70 <b>90</b>	mA max mA max
<b>VOLTAGE REFERENCE</b>					
$V_{\text{R}}$	Voltage Reference	(Note 9)	1.244	1.2191 1.2689 ( $\pm 2.0\%$ )	V min V max
$\frac{\Delta V_{\text{R}}}{\Delta T}$	Average Temperature Drift	(Note 10)	<b>10</b>	<b>150</b>	PPM/ $^\circ\text{C}$ max
$\frac{\Delta V_{\text{R}}}{\Delta T_{\text{J}}}$	Hysteresis	(Note 11)	<b>3.2</b>		$\mu\text{V}/^\circ\text{C}$
$\frac{\Delta V_{\text{R}}}{\Delta I_{\text{R}}}$	$V_{\text{R}}$ Change with Current	$V_{\text{R}(100\mu\text{A})} - V_{\text{R}(17\mu\text{A})}$	0.05 <b>0.1</b>	1 <b>1.1</b>	mV max mV max
		$V_{\text{R}(10\text{mA})} - V_{\text{R}(100\mu\text{A})}$ (Note 12)	1.5 <b>2.0</b>	5 <b>5.5</b>	mV max mV max
R	Resistance	$\Delta V_{\text{R}(10 \rightarrow 0.1\text{mA})} / 9.9\text{mA}$ $\Delta V_{\text{R}(100 \rightarrow 17\mu\text{A})} / 83\mu\text{A}$	<b>0.2</b> <b>0.6</b>	<b>0.56</b> <b>13</b>	$\Omega$ max $\Omega$ max
$\frac{\Delta V_{\text{R}}}{\Delta V_{\text{RO}}}$	$V_{\text{R}}$ Change with High $V_{\text{RO}}$	$V_{\text{R}(V_{\text{ro}} = V_{\text{r}})} - V_{\text{R}(V_{\text{ro}} = 5.0\text{V})}$ (3.76V between Anode and FEEDBACK)	2.5 <b>2.8</b>	7 <b>10</b>	mV max mV max
$\frac{\Delta V_{\text{R}}}{\Delta V^+}$	$V_{\text{R}}$ Change with $V^+$ Change	$V_{\text{R}(V^+ = 5\text{V})} - V_{\text{R}(V^+ = 36\text{V})}$ ( $V^+ = 32\text{V}$ for LM614C)	0.1 <b>0.1</b>	1.2 <b>1.3</b>	mV max mV max
		$V_{\text{R}(V^+ = 5\text{V})} - V_{\text{R}(V^+ = 3\text{V})}$	0.01 <b>0.01</b>	1 <b>1.5</b>	mV max mV max
$I_{\text{FB}}$	FEEDBACK Bias Current	$V_{\text{ANODE}} \leq V_{\text{FB}} \leq 5.06\text{V}$	22 <b>29</b>	50 <b>55</b>	nA max nA max
$e_{\text{n}}$	Voltage Noise	BW = 10 Hz to 10 kHz,	30		$\mu\text{V}_{\text{RMS}}$

## Electrical Characteristics (Continued)

These specifications apply for  $V^- = \text{GND} = 0\text{V}$ ,  $V^+ = 5\text{V}$ ,  $V_{\text{CM}} = V_{\text{OUT}} = 2.5\text{V}$ ,  $I_{\text{R}} = 100\mu\text{A}$ , FEEDBACK pin shorted to GND, unless otherwise specified. Limits in standard typeface are for  $T_{\text{J}} = 25^\circ\text{C}$ ; limits in **Boldface type** apply over the **Operating Temperature Range**.

Symbol	Parameter	Conditions	Typ (Note 6)	LM614 LM614C Limits (Note 7)	Units
		$V_{\text{RO}} = V_{\text{R}}$			

**Note 1:** Absolute maximum ratings indicate limits beyond which damage to the component may occur. Electrical specifications do not apply when operating the device beyond its rated operating conditions.

**Note 2:** Input voltage above  $V^+$  is allowed.

**Note 3:** More accurately, it is excessive current flow, with resulting excess heating, that limits the voltages on all pins. When any pin is pulled a diode drop below  $V^-$ , a parasitic NPN transistor turns ON. No latch-up will occur as long as the current through that pin remains below the Maximum Rating. Operation is undefined and unpredictable when any parasitic diode or transistor is conducting.

**Note 4:** Junction temperature may be calculated using  $T_{\text{J}} = T_{\text{A}} + P_{\text{D}}\theta_{\text{JA}}$ . The given thermal resistance is worst-case for packages in sockets in still air. For packages soldered to copper-clad board with dissipation from one comparator or reference output transistor, nominal  $\theta_{\text{JA}}$  is  $90^\circ\text{C}/\text{W}$  for the WM package.

**Note 5:** Human body model, 100 pF discharged through a 1.5 kΩ resistor.

**Note 6:** Typical values in standard typeface are for  $T_{\text{J}} = 25^\circ\text{C}$ ; values in **boldface type** apply for the full operating temperature range. These values represent the most likely parametric norm.

**Note 7:** All limits are guaranteed at room temperature (standard type face) or at operating temperature extremes (**bold type face**).

**Note 8:** Slew rate is measured with op amp in a voltage follower configuration. For rising slew rate, the input voltage is driven from 5V to 25V, and the output voltage transition is sampled at 10V and @20V. For falling slew rate, the input voltage is driven from 25V to 5V, and the output voltage transition is sampled at 20V and 10V.

**Note 9:**  $V_{\text{R}}$  is the Cathode-feedback voltage, nominally 1.244V.

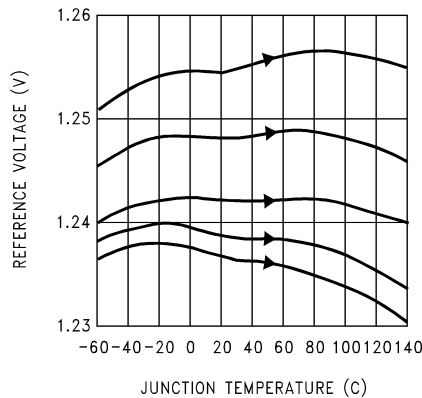
**Note 10:** Average reference drift is calculated from the measurement of the reference voltage at  $25^\circ\text{C}$  and at the temperature extremes. The drift, in ppm/ $^\circ\text{C}$ , is  $10^6 \cdot \Delta V_{\text{R}} / (V_{\text{R}[25^\circ\text{C}]} \cdot \Delta T_{\text{J}})$ , where  $\Delta V_{\text{R}}$  is the lowest value subtracted from the highest,  $V_{\text{R}[25^\circ\text{C}]}$  is the value at  $25^\circ\text{C}$ , and  $\Delta T_{\text{J}}$  is the temperature range. This parameter is guaranteed by design and sample testing.

**Note 11:** Hysteresis is the change in  $V_{\text{R}}$  caused by a change in  $T_{\text{J}}$ , after the reference has been "dehysterized". To dehysterize the reference; that is minimize the hysteresis to the typical value, cycle its junction temperature in the following pattern, spiraling in toward  $25^\circ\text{C}$ :  $25^\circ\text{C}$ ,  $85^\circ\text{C}$ ,  $-40^\circ\text{C}$ ,  $70^\circ\text{C}$ ,  $0^\circ\text{C}$ ,  $25^\circ\text{C}$ .

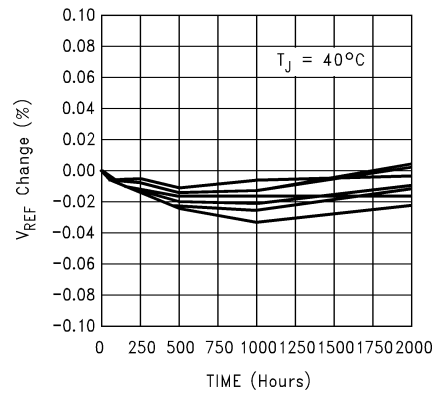
**Note 12:** Low contact resistance is required for accurate measurement.

## Typical Performance Characteristics (Reference) $T_{\text{J}} = 25^\circ\text{C}$ , FEEDBACK pin shorted to $V^- = 0\text{V}$ , unless otherwise noted

Reference Voltage vs. Temperature on 5 Representative Units

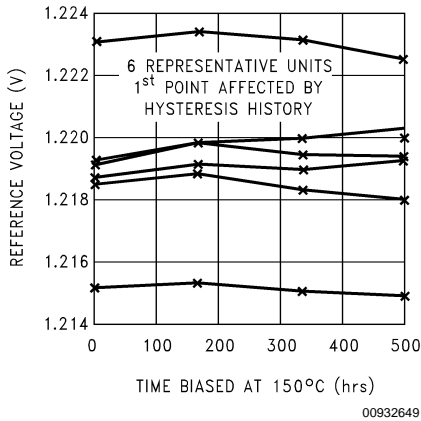


Reference Voltage Drift

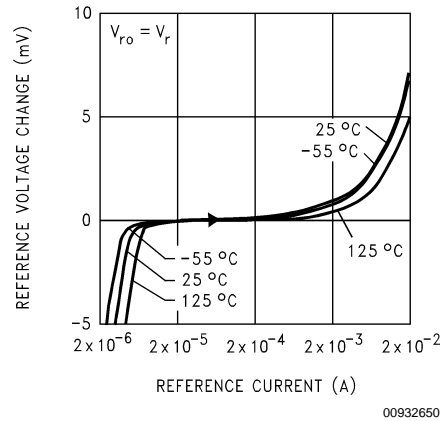


**Typical Performance Characteristics (Reference)**  $T_J = 25^\circ\text{C}$ , FEEDBACK pin shorted to  $V^- = 0\text{V}$ , unless otherwise noted (Continued)

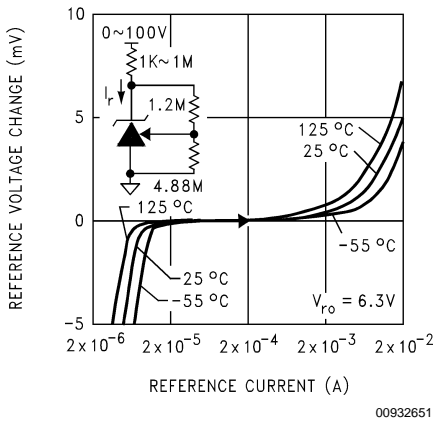
**Accelerated Reference Voltage Drift vs. Time**



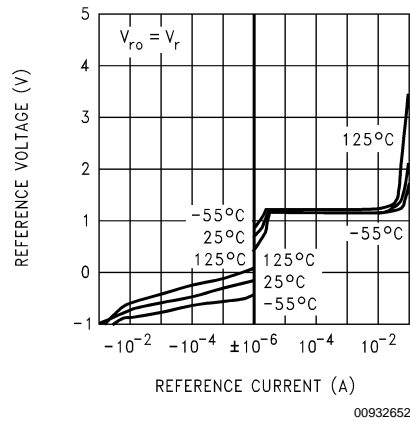
**Reference Voltage vs. Current and Temperature**



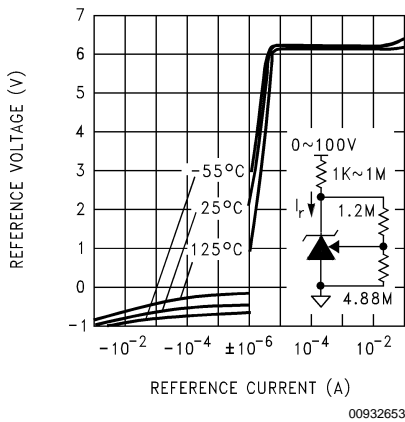
**Reference Voltage vs. Current and Temperature**



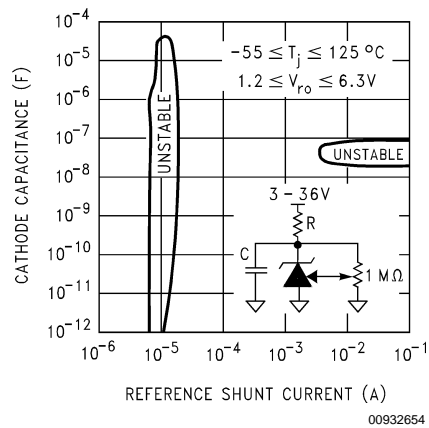
**Reference Voltage vs. Reference Current**



**Reference Voltage vs. Reference Current**

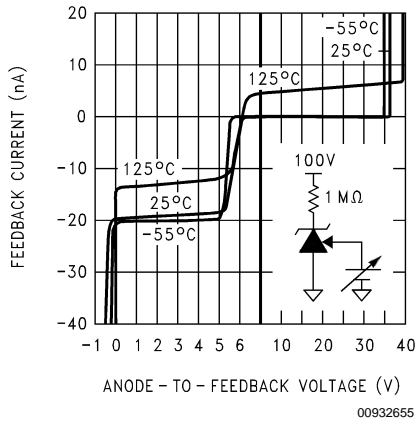


**Reference AC Stability Range**

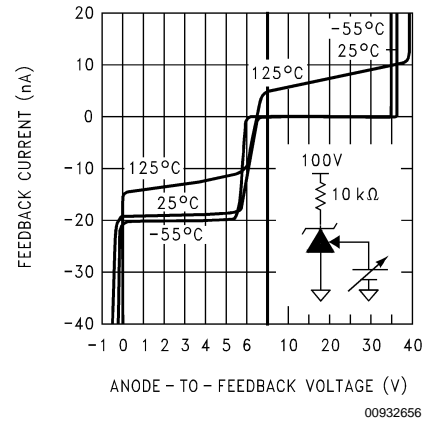


**Typical Performance Characteristics (Reference)**  $T_J = 25^\circ\text{C}$ , FEEDBACK pin shorted to  $V^- = 0\text{V}$ , unless otherwise noted (Continued)

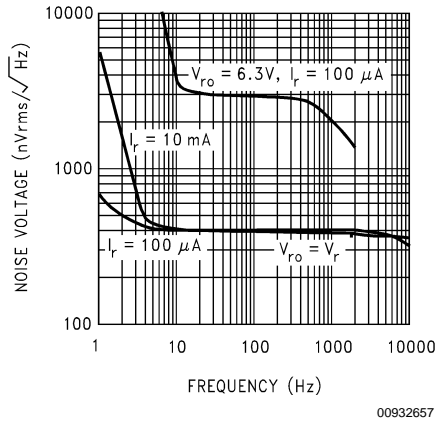
**FEEDBACK Current vs. FEEDBACK-to-Anode Voltage**



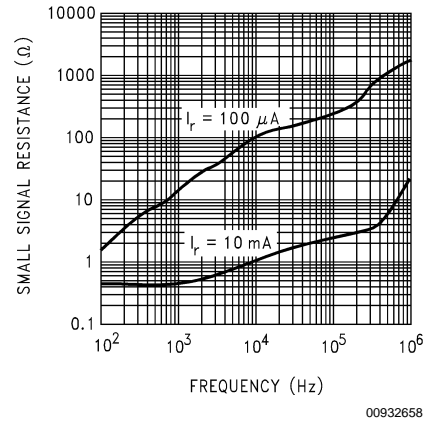
**FEEDBACK Current vs. FEEDBACK-to-Anode Voltage**



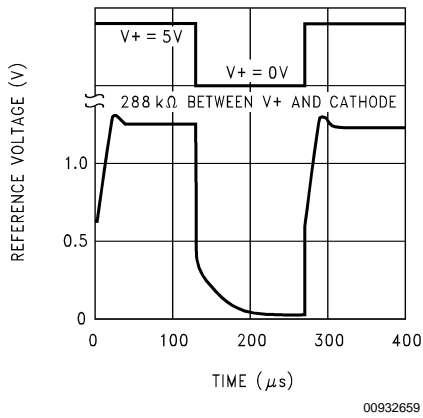
**Reference Noise Voltage vs. Frequency**



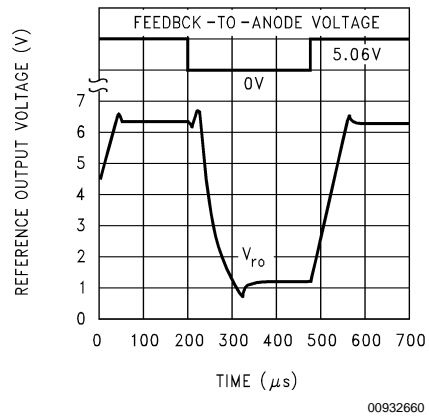
**Reference Small-Signal Resistance vs. Frequency**



**Reference Power-Up Time**

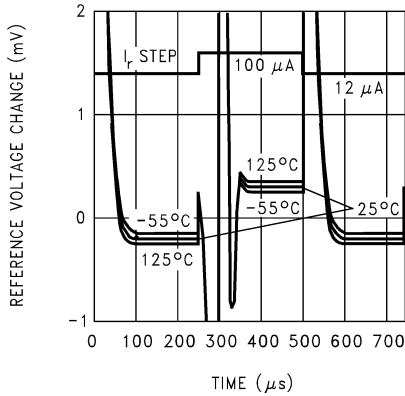


**Reference Voltage with FEEDBACK Voltage Step**



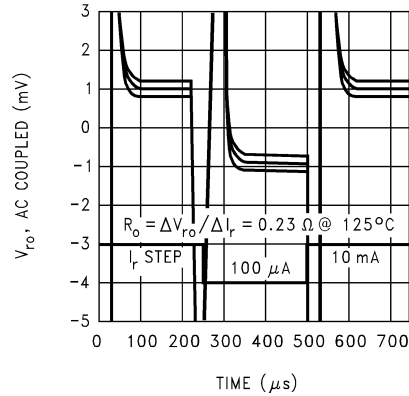
**Typical Performance Characteristics (Reference)**  $T_J = 25^\circ\text{C}$ , FEEDBACK pin shorted to  $V^- = 0\text{V}$ , unless otherwise noted (Continued)

Reference Voltage with 100–12  $\mu\text{A}$  Current Step



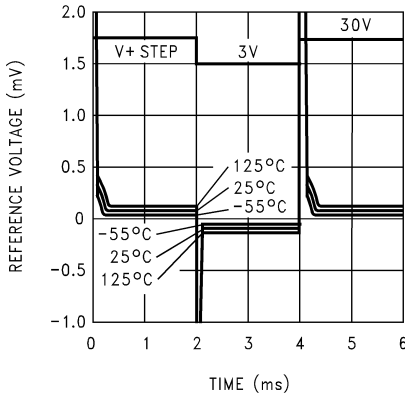
00932661

Reference Step Response for 100  $\mu\text{A}$  ~ 10 mA Current Step



00932662

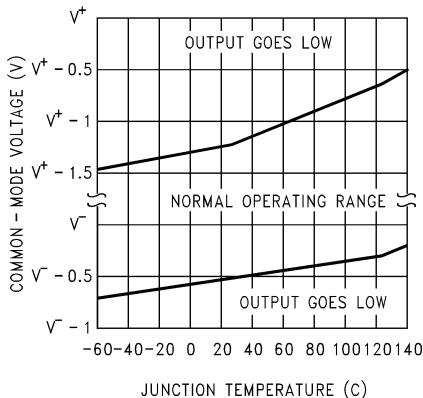
Reference Voltage Change with Supply Voltage Step



00932663

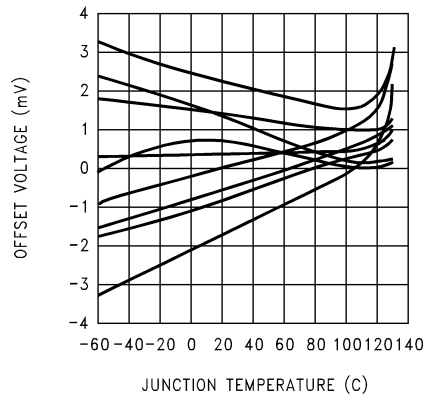
**Typical Performance Characteristics (Op Amps)**  $V^+ = 5\text{V}$ ,  $V^- = \text{GND} = 0\text{V}$ ,  $V_{CM} = V^+/2$ ,  $V_{OUT} = V^+/2$ ,  $T_J = 25^\circ\text{C}$ , unless otherwise noted

Input Common-Mode Voltage Range vs. Temperature



00932664

$V_{OS}$  vs. Junction Temperature on 9 Representative Units



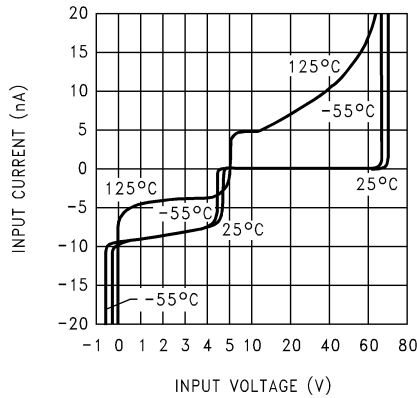
00932665

# Typical Performance Characteristics (Op Amps)

$V_{OUT} = V^+ / 2$ ,  $T_J = 25^\circ\text{C}$ , unless otherwise noted (Continued)

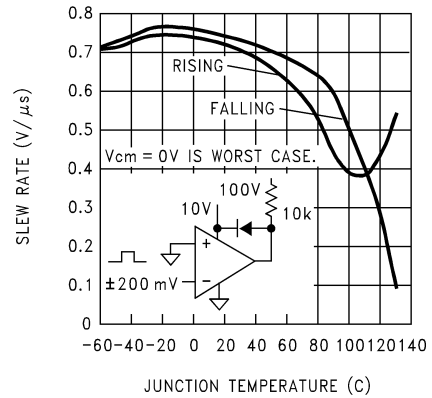
$V^+ = 5\text{V}$ ,  $V^- = \text{GND} = 0\text{V}$ ,  $V_{CM} = V^+ / 2$

**Input Bias Current vs. Common-Mode Voltage**



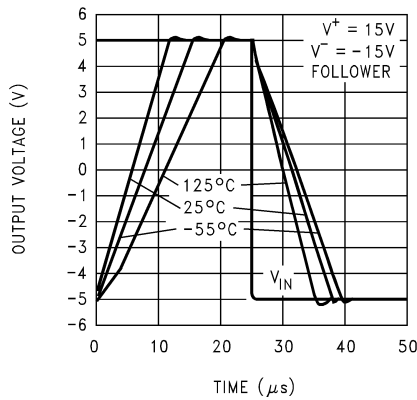
00932666

**Slew Rate vs. Temperature and Output Sink Current**



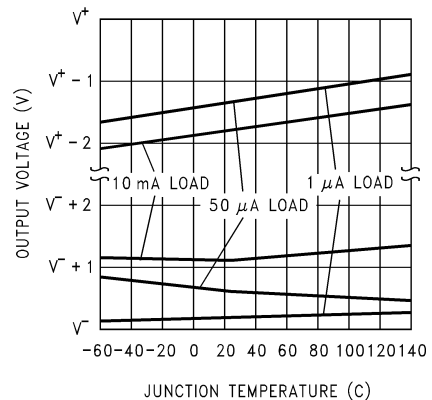
00932667

**Large-Signal Step Response**



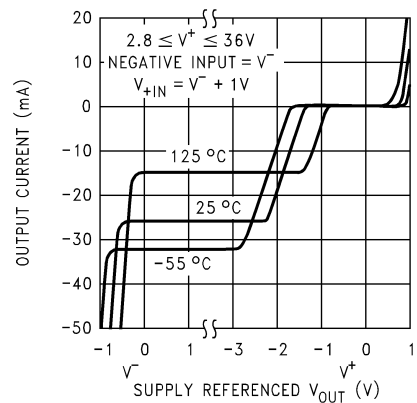
00932668

**Output Voltage Swing vs. Temp. and Current**



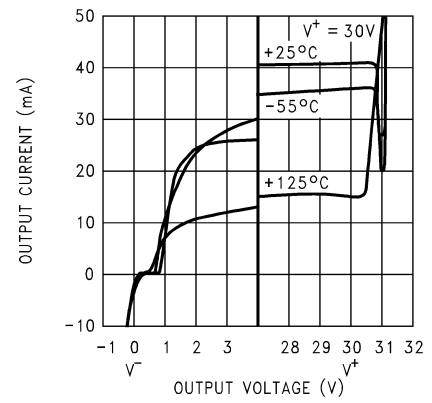
00932669

**Output Source Current vs. Output Voltage and Temp.**



00932670

**Output Sink Current vs. Output Voltage and Temp.**

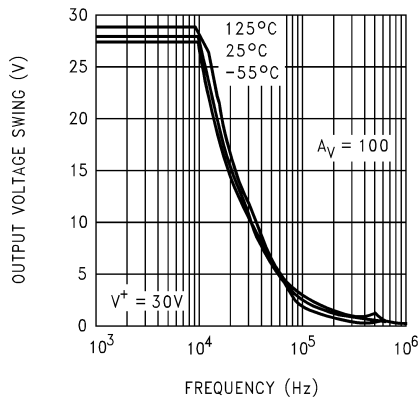


00932671

# Typical Performance Characteristics (Op Amps) $V^+ = 5V, V^- = GND = 0V, V_{CM} = V^+/2,$

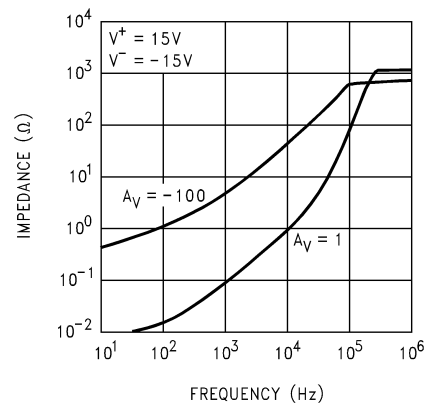
$V_{OUT} = V^+/2, T_J = 25^\circ C,$  unless otherwise noted (Continued)

**Output Swing, Large Signal**



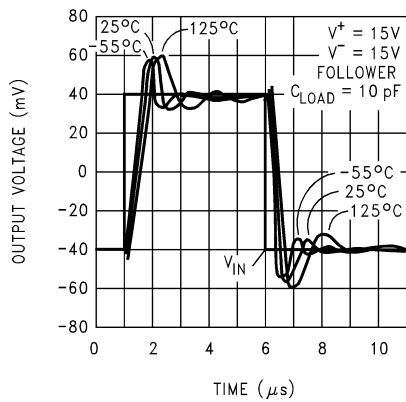
00932672

**Output Impedance vs. Frequency and Gain**



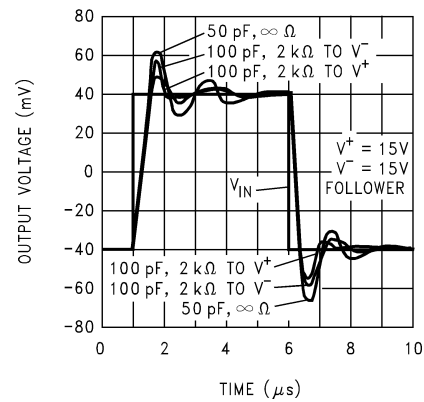
00932673

**Small-Signal Pulse Response vs. Temp.**



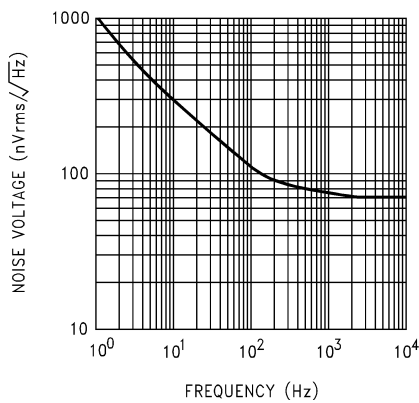
00932674

**Small-Signal Pulse Response vs. Load**



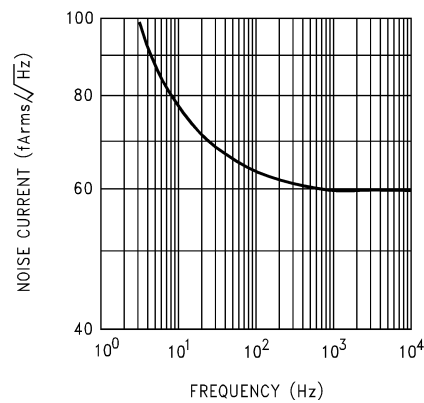
00932675

**Op Amp Voltage Noise vs. Frequency**



00932676

**Op Amp Current Noise vs. Frequency**

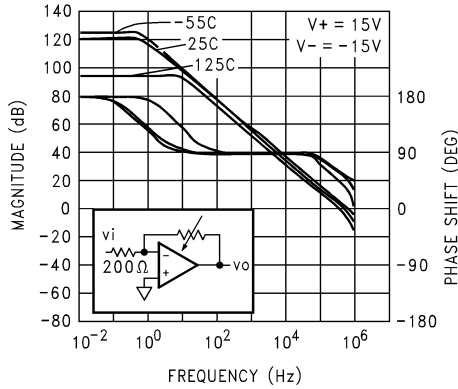


00932677

# Typical Performance Characteristics (Op Amps)

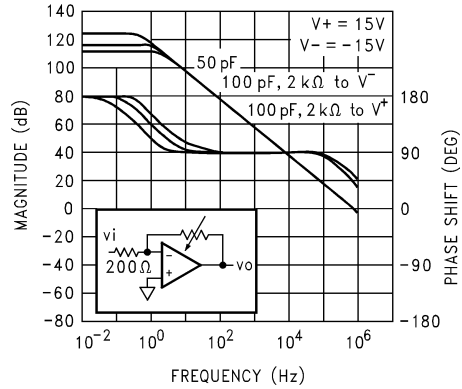
$V^+ = 5V, V^- = GND = 0V, V_{CM} = V^+/2, V_{OUT} = V^+/2, T_J = 25^\circ C$ , unless otherwise noted (Continued)

**Small-Signal Voltage Gain vs. Frequency and Temperature**



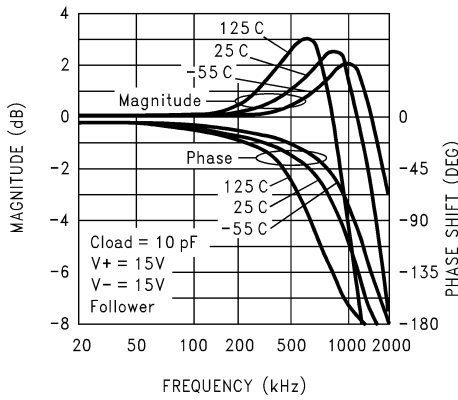
00932678

**Small-Signal Voltage Gain vs. Frequency and Load**



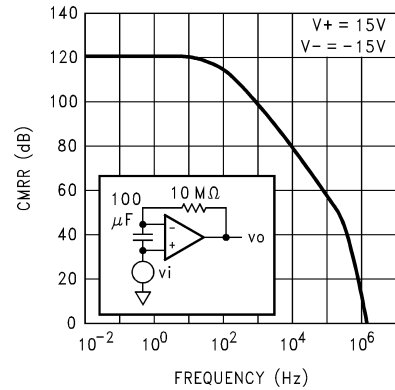
00932679

**Follower Small-Signal Frequency Response**



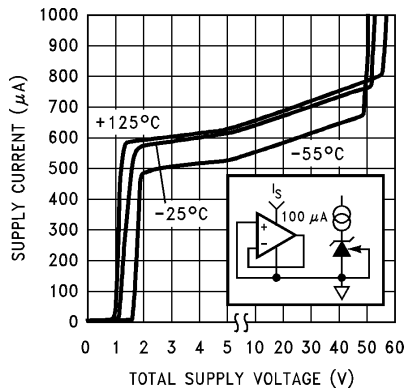
00932680

**Common-Mode Input Voltage Rejection Ratio**



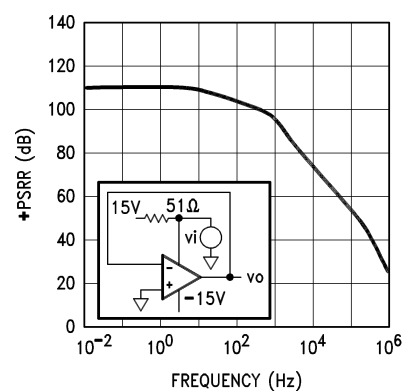
00932681

**Power Supply Current vs. Power Supply Voltage**



00932607

**Positive Power Supply Voltage Rejection Ratio**

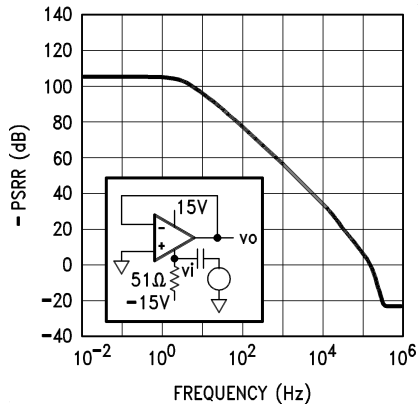


00932621

# Typical Performance Characteristics (Op Amps) $V^+ = 5V, V^- = GND = 0V, V_{CM} = V^+/2,$

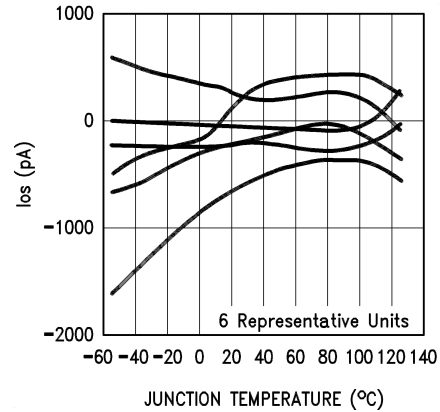
$V_{OUT} = V^+/2, T_J = 25^\circ C,$  unless otherwise noted (Continued)

**Negative Power Supply Voltage Rejection Ratio**



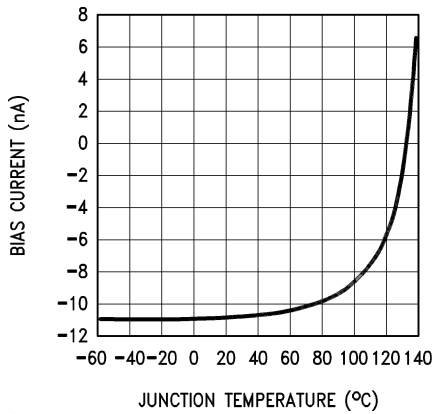
00932622

**Input Offset Current vs. Junction Temperature**



00932624

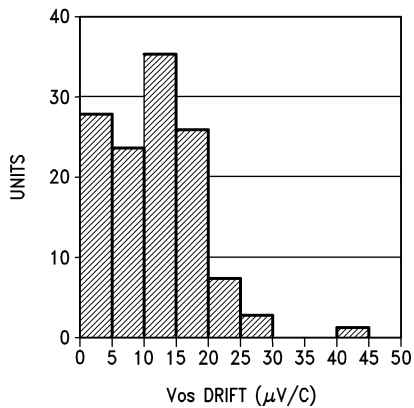
**Input Bias Current vs. Junction Temperature**



00932638

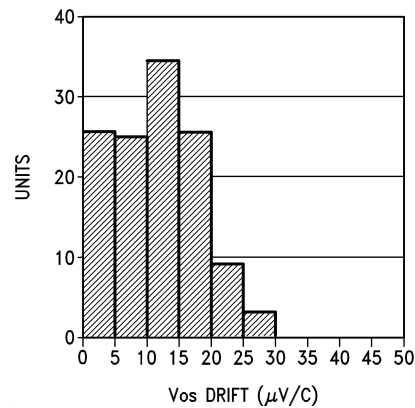
## Typical Performance Distributions

**Average  $V_{OS}$  Drift Industrial Temperature Range**



00932630

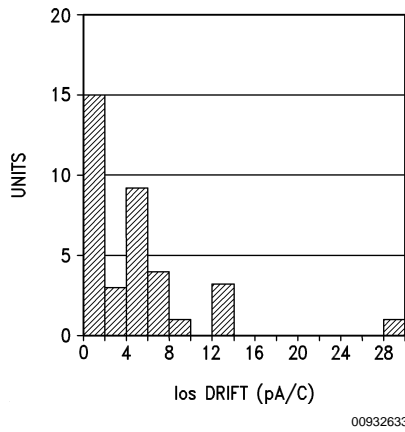
**Average  $V_{OS}$  Drift Commercial Temperature Range**



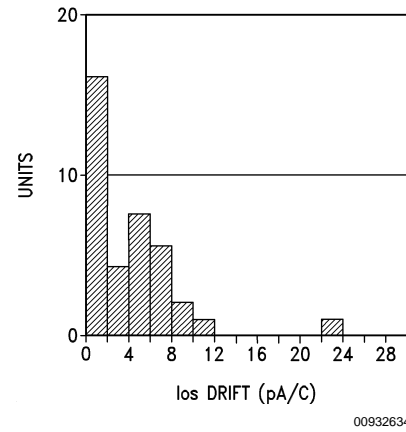
00932631

# Typical Performance Distributions (Continued)

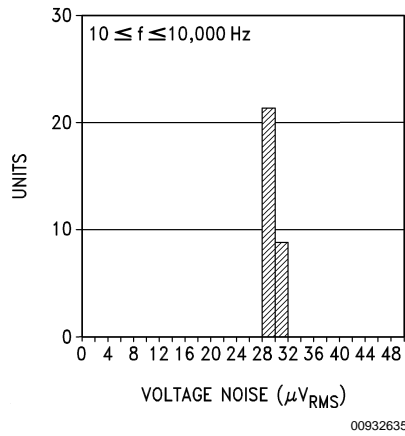
Average  $I_{OS}$  Drift Industrial Temperature Range



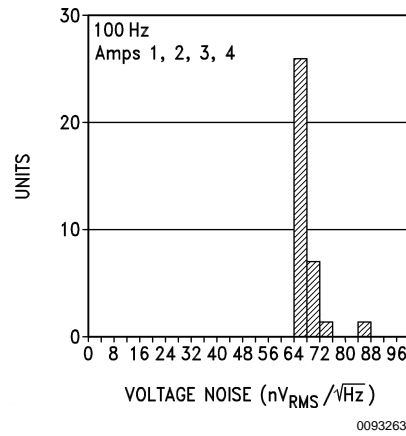
Average  $I_{OS}$  Drift Commercial Temperature Range



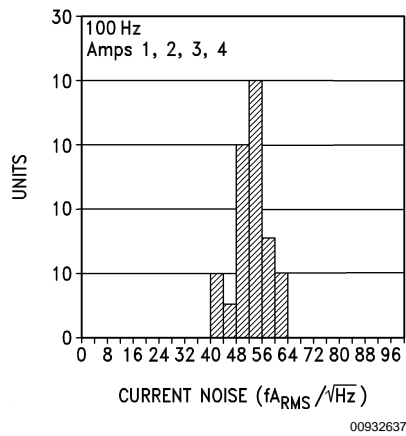
Voltage Reference Broad-Band Noise Distribution



Op Amp Voltage Noise Distribution



Op Amp Current Noise Distribution

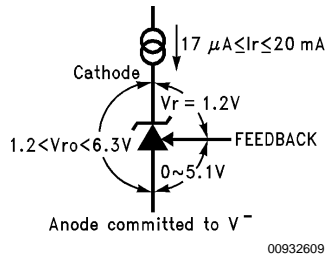


## Application Information

### VOLTAGE REFERENCE

#### Reference Biasing

The voltage reference is of a shunt regulator topology that models as a simple zener diode. With current  $I_r$  flowing in the “forward” direction there is the familiar diode transfer function.  $I_r$  flowing in the reverse direction forces the reference voltage to be developed from cathode to anode. The cathode may swing from a diode drop below  $V^-$  to the reference voltage or to the avalanche voltage of the parallel protection diode, nominally 7V. A 5.0V reference with  $V^+ = 3V$  is allowed.



**FIGURE 1. Voltages Associated with Reference (Current Source  $I_r$  is External)**

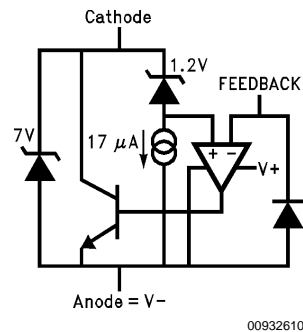
The reference equivalent circuit reveals how  $V_r$  is held at the constant 1.2V by feedback, and how the FEEDBACK pin passes little current.

To generate the required reverse current, typically a resistor is connected from a supply voltage higher than the reference voltage. Varying that voltage, and so varying  $I_r$ , has small effect with the equivalent series resistance of less than an ohm at the higher currents. Alternatively, an active current source, such as the LM134 series, may generate  $I_r$ .

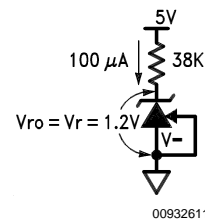
#### Adjustable Reference

The FEEDBACK pin allows the reference output voltage,  $V_{ro}$ , to vary from 1.24V to 5.0V. The reference attempts to hold  $V_r$  at 1.24V. If  $V_r$  is above 1.24V, the reference will conduct current from Cathode to Anode; FEEDBACK current always remains low. If FEEDBACK is connected to Anode, then  $V_{ro} = V_r = 1.24V$ . For higher voltages FEEDBACK is held at a constant voltage above Anode—say 3.76V for  $V_{ro} = 5V$ . Connecting a resistor across the constant  $V_r$  generates a current  $I = V_r/R1$  flowing from Cathode into FEEDBACK node. A Thevenin equivalent 3.76V is generated from FEEDBACK to Anode with  $R2 = 3.76/I$ . For a 1% error, use  $R1$  such that  $I$  is greater than one hundred times the FEEDBACK bias current. For example, keep  $I \geq 5.5 \mu A$ .

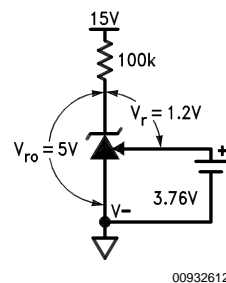
Capacitors in parallel with the reference are allowed. See the Reference AC Stability Range typical curve for capacitance values—from 20  $\mu A$  to 3 mA any capacitor value is stable. With the reference's wide stability range with resistive and capacitive loads, a wide range of RC filter values will perform noise filtering.



**FIGURE 2. Reference Equivalent Circuit**

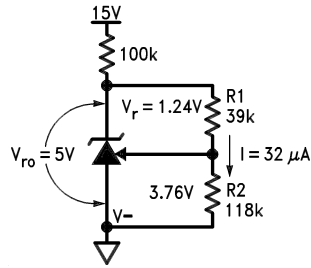


**FIGURE 3. 1.2V Reference**



**FIGURE 4. Thevenin Equivalent of Reference with 5V Output**

Application Information (Continued)

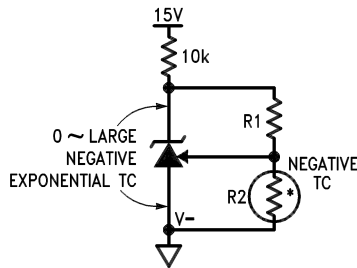


00932613

$R1 = Vr/I = 1.24/32\mu = 39k$   
 $R2 = R1 \{(Vro/Vr) - 1\} = 39k \{(5/1.24) - 1\} = 118k$

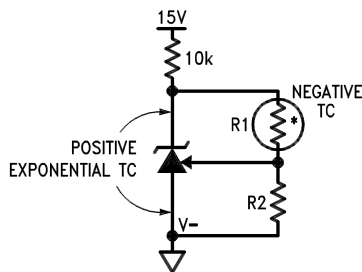
FIGURE 5. Resistors R1 and R2 Program Reference Output Voltage to be 5V

Understanding that  $V_r$  is fixed and that voltage sources, resistors, and capacitors may be tied to the FEEDBACK pin, a range of  $V_r$  temperature coefficients may be synthesized.



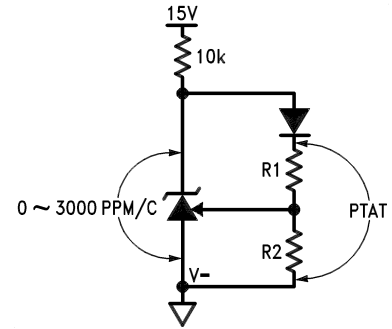
00932614

FIGURE 6. Output Voltage has Negative Temperature Coefficient (TC) if R2 has Negative TC



00932615

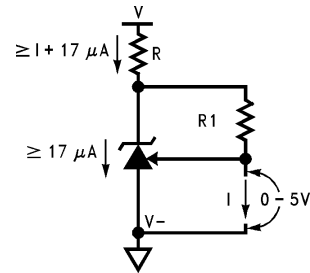
FIGURE 7. Output Voltage has Positive TC if R1 has Negative TC



00932616

FIGURE 8. Diode in Series with R1 Causes Voltage across R1 and R2 to be Proportional to Absolute Temperature (PTAT)

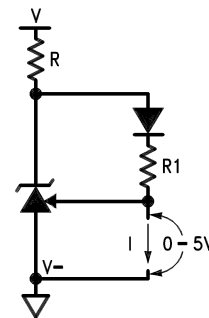
Connecting a resistor across Cathode-to-FEEDBACK creates a 0 TC current source, but a range of TCs may be synthesized.



00932617

$I = Vr/R1 = 1.24/R1$

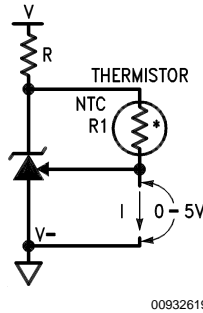
FIGURE 9. Current Source is Programmed by R1



00932618

FIGURE 10. Proportional-to-Absolute-Temperature Current Source

## Application Information (Continued)



**FIGURE 11. Negative-TC Current Source**

### Hysteresis

The reference voltage depends, slightly, on the thermal history of the die. Competitive micro-power products vary—always check the data sheet for any given device. Do not assume that no specification means no hysteresis.

### OPERATIONAL AMPLIFIERS

Any amp or the reference may be biased in any way with no effect on the other amps or reference, except when a substrate diode conducts (see Guaranteed Electrical Characteristics (Note 1)). One amp input may be outside the common-mode range, another amp may be operated as a comparator, another with all terminals floating with no effect on the others (tying inverting input to output and

non-inverting input to  $V^-$  on unused amps is preferred). Choosing operating points that cause oscillation, such as driving too large a capacitive load, is best avoided.

### Op Amp Output Stage

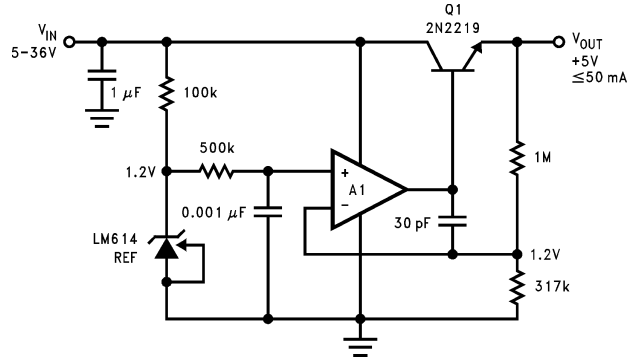
These op amps, like their LM124 series, have flexible and relatively wide-swing output stages. There are simple rules to optimize output swing, reduce cross-over distortion, and optimize capacitive drive capability:

1. **Output Swing:** Unloaded, the  $42\mu\text{A}$  pull-down will bring the output within 300 mV of  $V^-$  over the military temperature range. If more than  $42\mu\text{A}$  is required, a resistor from output to  $V^-$  will help. Swing across any load may be improved slightly if the load can be tied to  $V^+$ , at the cost of poorer sinking open-loop voltage gain
2. **Cross-over Distortion:** The LM614 has lower cross-over distortion (a  $1 V_{BE}$  deadband versus  $3 V_{BE}$  for the LM124), and increased slew rate as shown in the characteristic curves. A resistor pull-up or pull-down will force class-A operation with only the PNP or NPN output transistor conducting, eliminating cross-over distortion
3. **Capacitive Drive:** Limited by the output pole caused by the output resistance driving capacitive loads, a pull-down resistor conducting 1 mA or more reduces the output stage NPN  $r_o$  until the output resistance is that of the current limit  $25\Omega$ . 200pF may then be driven without oscillation.

### Op Amp Input Stage

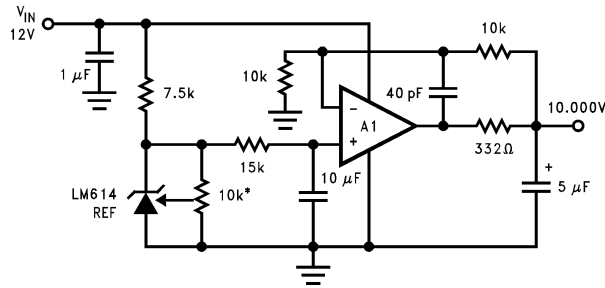
The lateral PNP input transistors, unlike most op amps, have  $BV_{EBO}$  equal to the absolute maximum supply voltage. Also, they have no diode clamps to the positive supply nor across the inputs. These features make the inputs look like high impedances to input sources producing large differential and common-mode voltages.

## Typical Applications



00932642

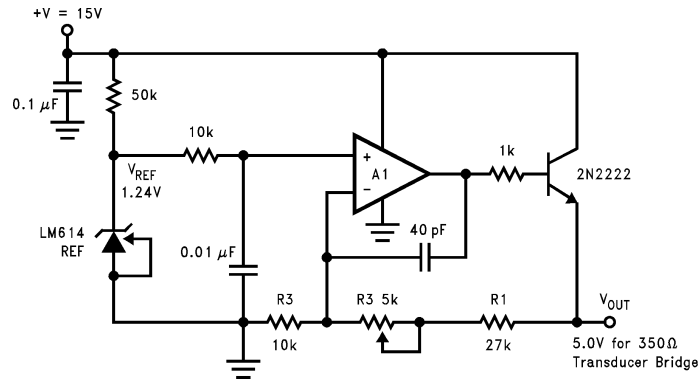
FIGURE 12. Simple Low Quiescent Drain Voltage Regulator. Total supply current approximately 320μA, when VIN = +5V.



00932643

\*10k must be low  
t.c. trimpot.

FIGURE 13. Ultra Low Noise 10.00V Reference. Total output noise is typically 14μVRMS.



00932644

$V_{OUT} = (R_1 / P_e + 1) V_{REF}$   
R<sub>1</sub>, R<sub>2</sub> should be 1% metal film  
P<sub>β</sub> should be low T.C. trim pot

FIGURE 14. Slow Rise Time Upon Power-Up, Adjustable Transducer Bridge Driver. Rise time is approximately 1ms.

# Typical Applications (Continued)

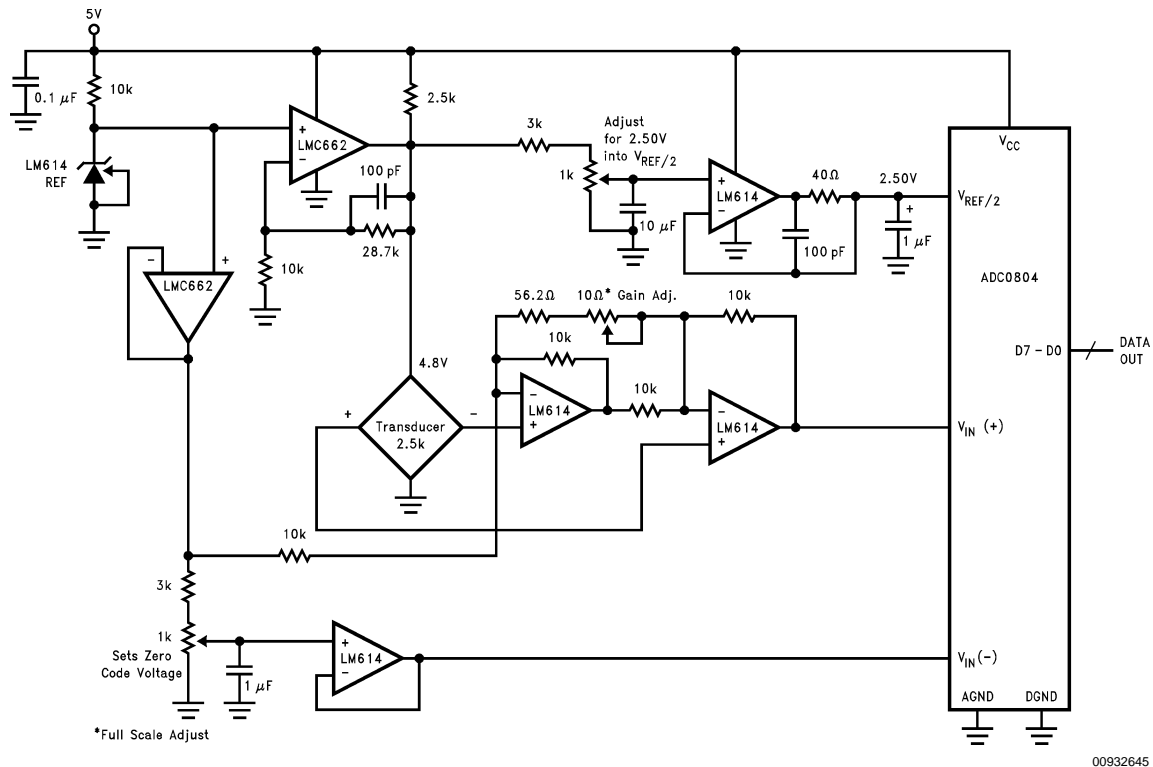
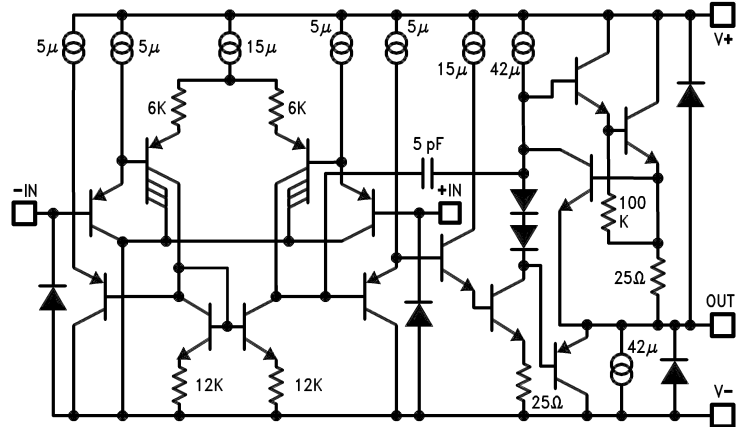


FIGURE 15. Transducer Data Acquisition System. Set zero code voltage, then adjust 10  $\Omega$  gain adjust pot for full scale.

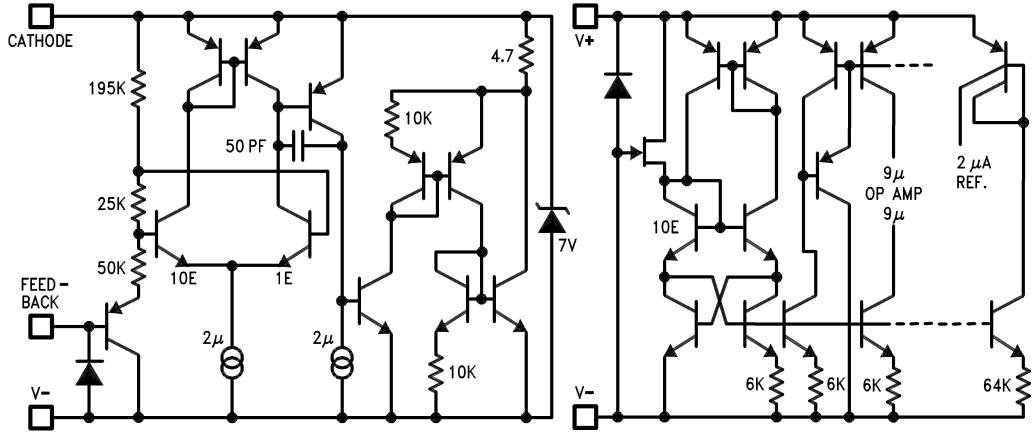
# Simplified Schematic Diagrams

Op Amp



00932602

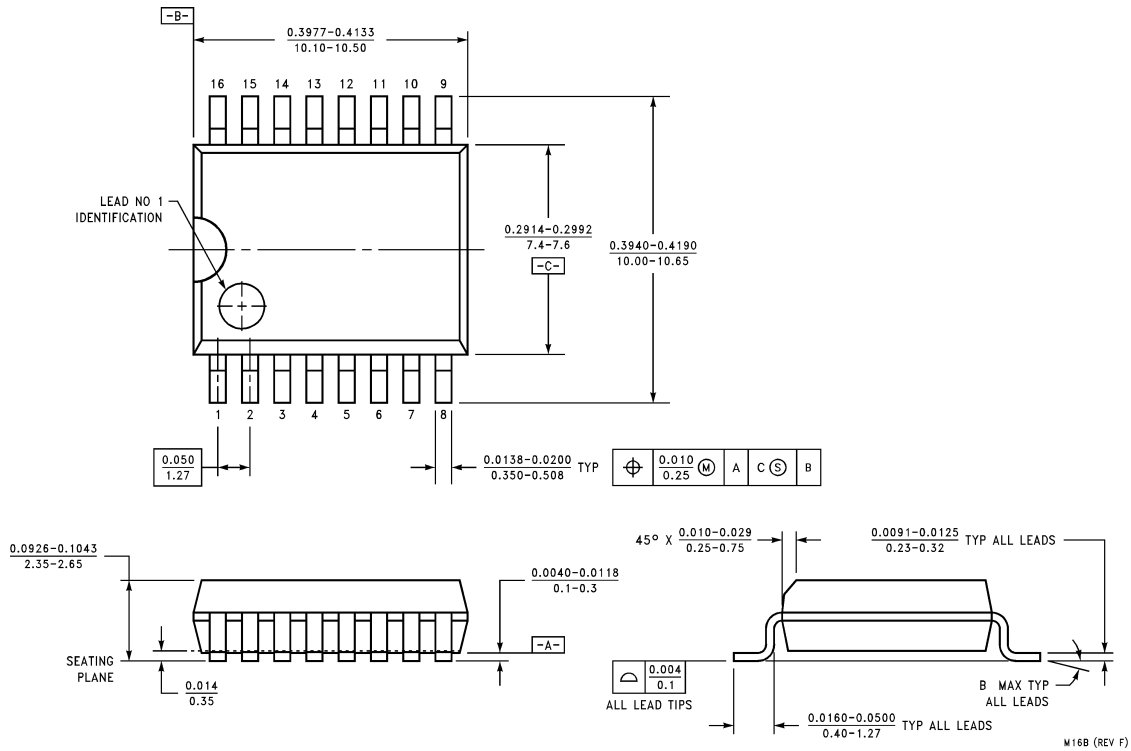
Reference / Bias



00932603

## Physical Dimensions inches (millimeters)

unless otherwise noted



**16-Lead Molded Small Outline Package (WM)  
NS Package Number M16B**

### LIFE SUPPORT POLICY

NATIONAL'S PRODUCTS ARE NOT AUTHORIZED FOR USE AS CRITICAL COMPONENTS IN LIFE SUPPORT DEVICES OR SYSTEMS WITHOUT THE EXPRESS WRITTEN APPROVAL OF THE PRESIDENT AND GENERAL COUNSEL OF NATIONAL SEMICONDUCTOR CORPORATION. As used herein:

1. Life support devices or systems are devices or systems which, (a) are intended for surgical implant into the body, or (b) support or sustain life, and whose failure to perform when properly used in accordance with instructions for use provided in the labeling, can be reasonably expected to result in a significant injury to the user.
2. A critical component is any component of a life support device or system whose failure to perform can be reasonably expected to cause the failure of the life support device or system, or to affect its safety or effectiveness.



**National Semiconductor Corporation**  
Americas  
Email: support@nsc.com

**National Semiconductor Europe**  
Fax: +49 (0) 180-530 85 86  
Email: europe.support@nsc.com  
Deutsch Tel: +49 (0) 69 9508 6208  
English Tel: +44 (0) 870 24 0 2171  
Français Tel: +33 (0) 1 41 91 8790

**National Semiconductor Asia Pacific Customer Response Group**  
Tel: 65-2544466  
Fax: 65-2504466  
Email: ap.support@nsc.com

**National Semiconductor Japan Ltd.**  
Tel: 81-3-5639-7560  
Fax: 81-3-5639-7507

www.national.com

## Looking for pricing, stock, or lifecycle information?

Click below to explore more details on WIN SOURCE:

 [View LM614CWMX on WIN SOURCE](#)

 [Texas Instruments](#) Information

## Optimize Your Supply Chain with WIN SOURCE Solutions

-  Global Sourcing Solution
-  Obsolete Management
-  Cost Control Management
-  Shortage Management
-  Alternative Solution
-  Excess Inventory Management