



THE DATASHEET OF LM837MX/NOPB



LM837 Low Noise Quad Operational Amplifier

 Check for Samples: [LM837](#)

FEATURES

- High Slew Rate 10 V/μs (typ); 8 V/μs (min)
- Wide Gain Bandwidth Product 25 MHz (typ); 15 MHz (min)
- Power Bandwidth 200 kHz (typ)
- High Output Current ±40 mA
- Excellent Output Drive Performance >600Ω
- Low Input Noise Voltage 4.5 nV/√Hz
- Low Total Harmonic Distortion 0.0015%
- Low Offset Voltage 0.3 mV

DESCRIPTION

The LM837 is a quad operational amplifier designed for low noise, high speed and wide bandwidth performance. It has a new type of output stage which can drive a 600Ω load, making it ideal for almost all digital audio, graphic equalizer, preamplifiers, and professional audio applications. Its high performance characteristics also make it suitable for instrumentation applications where low noise is the key consideration.

The LM837 is internally compensated for unity gain operation. It is pin compatible with most other standard quad op amps and can therefore be used to upgrade existing systems with little or no change.

Schematic and Connection Diagrams

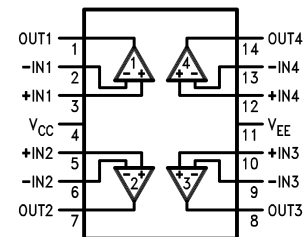
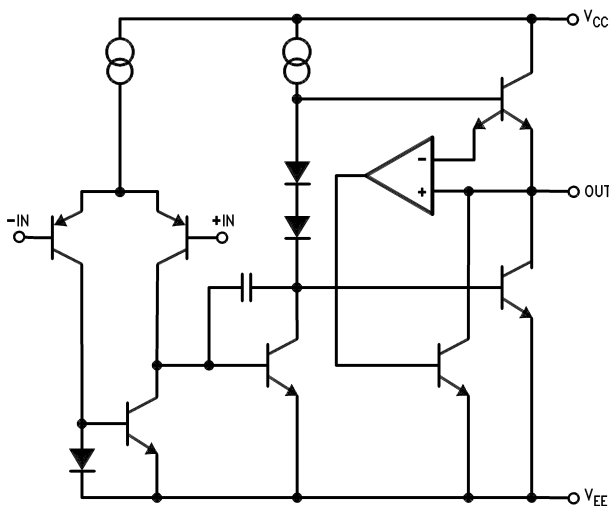

**Figure 1. PDIP Package
Top View
See Package Number
D0014A or NFF0014A**



Please be aware that an important notice concerning availability, standard warranty, and use in critical applications of Texas Instruments semiconductor products and disclaimers thereto appears at the end of this data sheet.

All trademarks are the property of their respective owners.



These devices have limited built-in ESD protection. The leads should be shorted together or the device placed in conductive foam during storage or handling to prevent electrostatic damage to the MOS gates.

ABSOLUTE MAXIMUM RATINGS⁽¹⁾⁽²⁾

Supply Voltage, V_{CC}/V_{EE}	±18V
Differential Input Voltage, $V_{ID}^{(3)}$	±30V
Common Mode Input Voltage, $V_{IC}^{(3)}$	±15V
Power Dissipation, $P_D^{(4)}$	1.2W (N) 830 mW (M)
Operating Temperature Range, T_{OPR}	-40°C to +85°C
Storage Temperature Range, T_{STG}	-60°C to +150°C
Soldering Information PDIP Package Soldering (10 seconds)	260°C
SOIC Package Vapor Phase (60 seconds)	215°C
Infrared (15 seconds)	220°C
ESD rating to be determined.	
See http://www.ti.com for other methods of soldering surface mount devices.	

- (1) Absolute Maximum Ratings indicate limits beyond which damage to the device may occur. Operating Ratings indicate conditions for which the device is functional, but do not ensure specific performance limits. Electrical Characteristics state DC and AC electrical specifications under particular test conditions which ensure specific performance limits. This assumes that the device is within the Operating Ratings. Specifications are not specified for parameters where no limit is given, however, the typical value is a good indication of device performance.
- (2) If Military/Aerospace specified devices are required, please contact the Texas Instruments Sales Office/Distributors for availability and specifications.
- (3) Unless otherwise specified the absolute maximum input voltage is equal to the power supply voltage.
- (4) For operation at ambient temperatures above 25°C, the device must be derated based on a 150°C maximum junction temperature and a thermal resistance, junction to ambient, as follows: LM837N, 90°C/W; LM837M, 150°C/W.

DC ELECTRICAL CHARACTERISTICS

$T_A = 25^\circ\text{C}$, $V_S = \pm 15\text{V}$

Symbol	Parameter	Condition	Min	Typ	Max	Units
V_{OS}	Input Offset Voltage	$R_S = 50\Omega$		0.3	5	mV
I_{OS}	Input Offset Current			10	200	nA
I_B	Input Bias Current			500	1000	nA
A_V	Large Signal Voltage Gain	$R_L = 2\text{ k}\Omega$, $V_{OUT} = \pm 10\text{V}$	90	110		dB
V_{OM}	Output Voltage Swing	$R_L = 2\text{ k}\Omega$	±12	±13.5		V
		$R_L = 600\Omega$	±10	±12.5		V
V_{CM}	Common Mode Input Voltage		±12	±14.0		V
CMRR	Common Mode Rejection Ratio	$V_{IN} = \pm 12\text{V}$	80	100		dB
PSRR	Power Supply Rejection Ratio	$V_S = 15 \sim 5$, $-15 \sim -5$	80	100		dB
I_S	Power Supply Current	$R_L = \infty$, Four Amps		10	15	mA

AC ELECTRICAL CHARACTERISTICS

$T_A = 25^\circ\text{C}$, $V_S = \pm 15\text{V}$

Symbol	Parameter	Condition	Min	Typ	Max	Units
SR	Slew Rate	$R_L = 600\Omega$	8	10		V/μs
GBW	Gain Bandwidth Product	$f = 100\text{ kHz}$, $R_L = 600\Omega$	15	25		MHz

DESIGN ELECTRICAL CHARACTERISTICS

 $T_A = 25^\circ\text{C}$, $V_S = \pm 15\text{V}$ ⁽¹⁾

Symbol	Parameter	Condition	Min	Typ	Max	Units
PBW	Power Bandwidth	$V_O = 25\text{ V}_{P-P}$, $R_L = 600\Omega$, THD < 1%		200		kHz
e_{n1}	Equivalent Input Noise Voltage	JIS A, $R_S = 100\Omega$		0.5		μV
e_{n2}	Equivalent Input Noise Voltage	$f = 1\text{ kHz}$		4.5		$\text{nV}/\sqrt{\text{Hz}}$
i_n	Equivalent Input Noise Current	$f = 1\text{ kHz}$		0.7		$\text{pA}/\sqrt{\text{Hz}}$
THD	Total Harmonic Distortion	$A_V = 1$, $V_{OUT} = 3\text{ V}_{rms}$, $f = 20 \sim 20\text{ kHz}$, $R_L = 600\Omega$		0.0015		%
f_U	Zero Cross Frequency	Open Loop		12		MHz
Φ_m	Phase Margin	Open Loop		45		deg
	Input-Referred Crosstalk	$f = 20 \sim 20\text{ kHz}$		-120		dB
$\frac{\Delta V_{OS}}{\Delta T}$	Average TC of Input Offset Voltage			2		$\mu\text{V}/^\circ\text{C}$

(1) The following parameters are not tested or ensured.

DETAILED SCHEMATIC

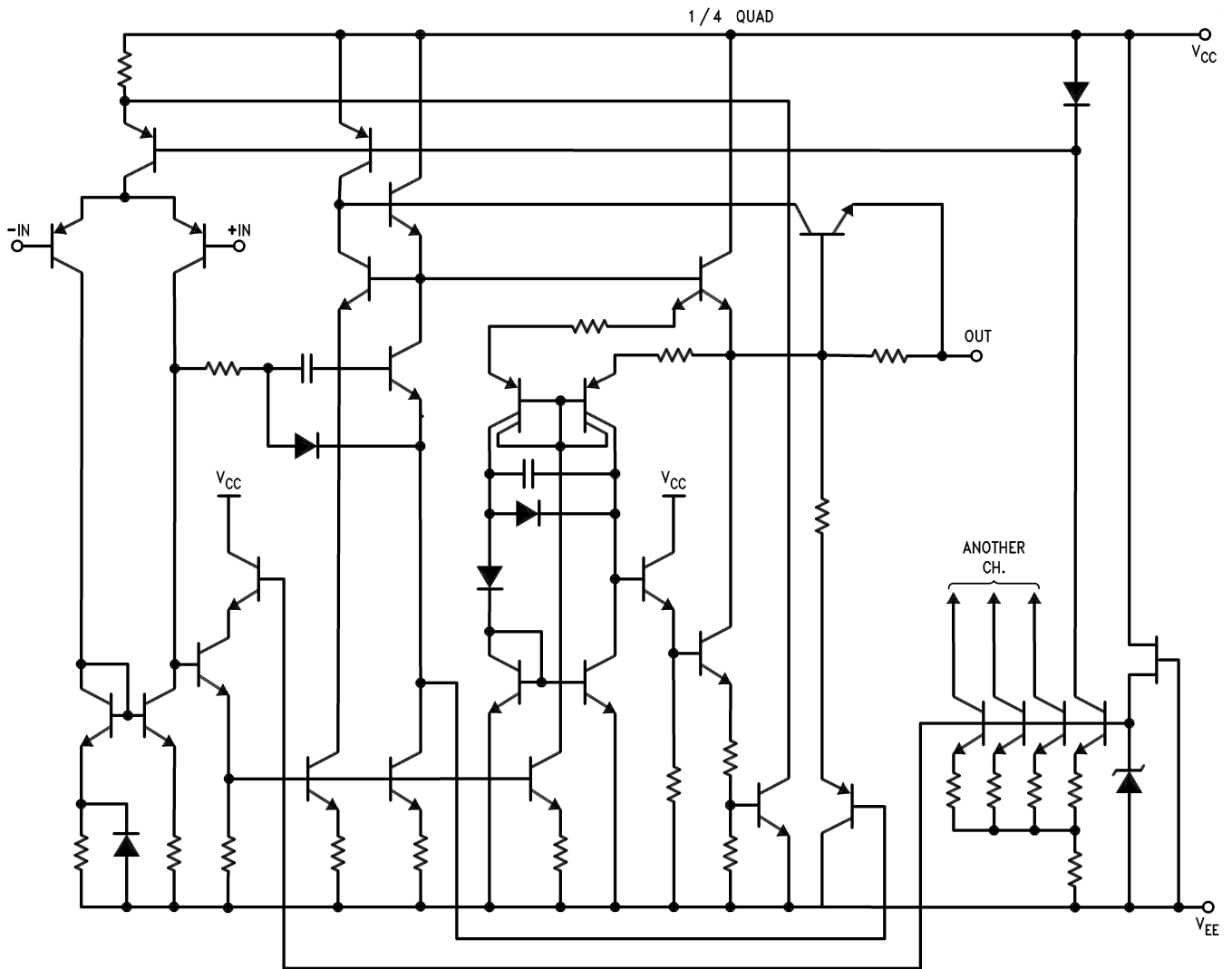

TYPICAL PERFORMANCE CHARACTERISTICS

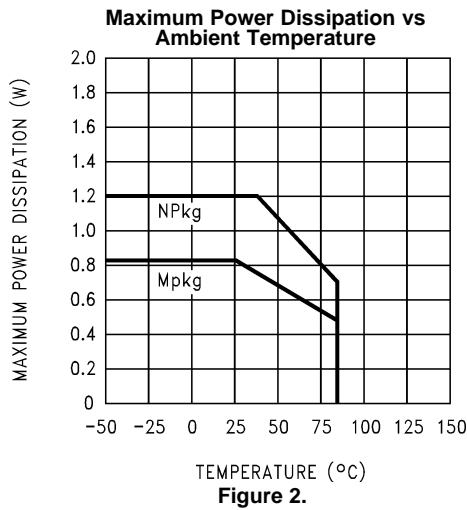

Figure 2.

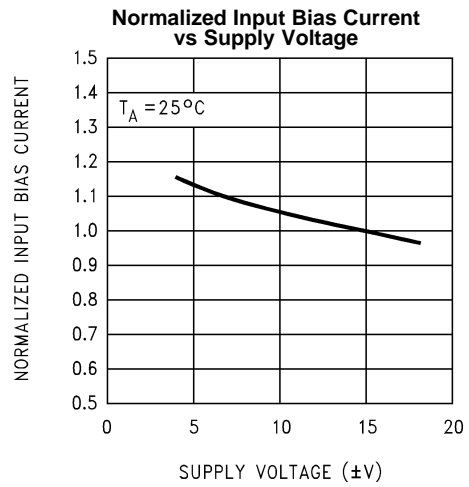

Figure 3.

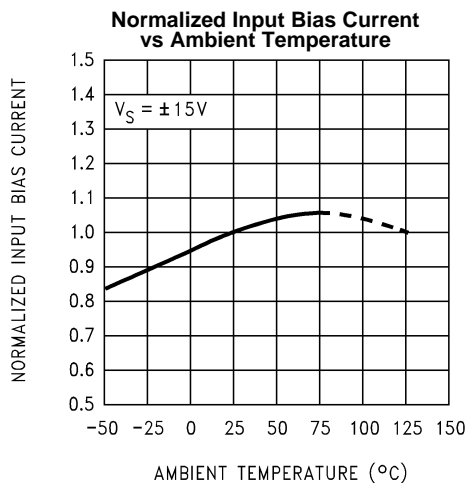

Figure 4.

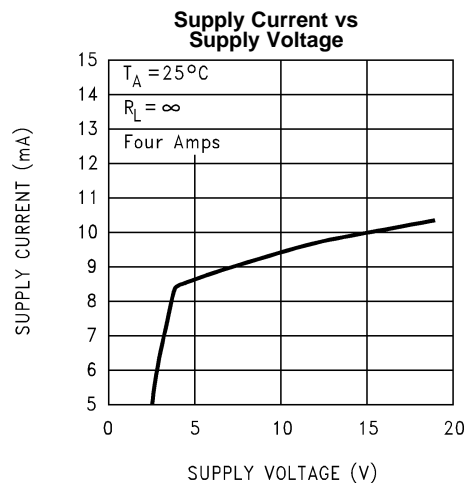

Figure 5.

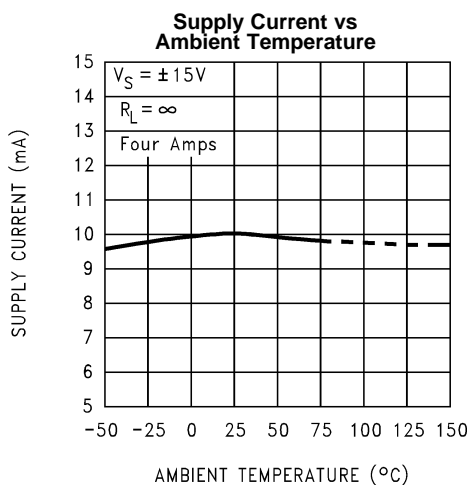

Figure 6.

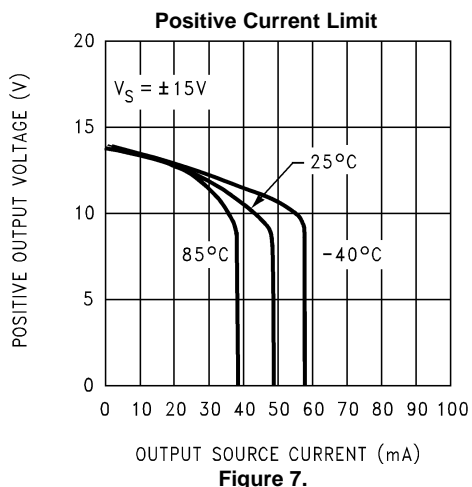

Figure 7.

TYPICAL PERFORMANCE CHARACTERISTICS (continued)

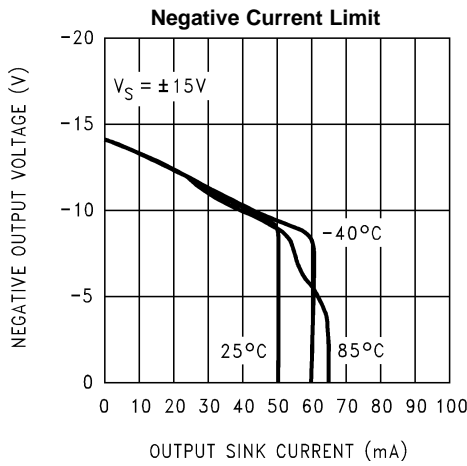

Figure 8.

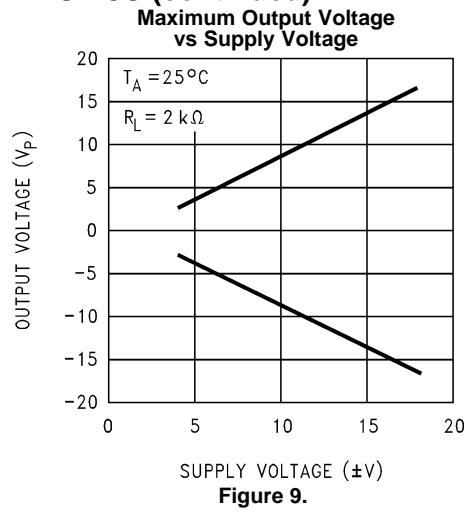

Figure 9.

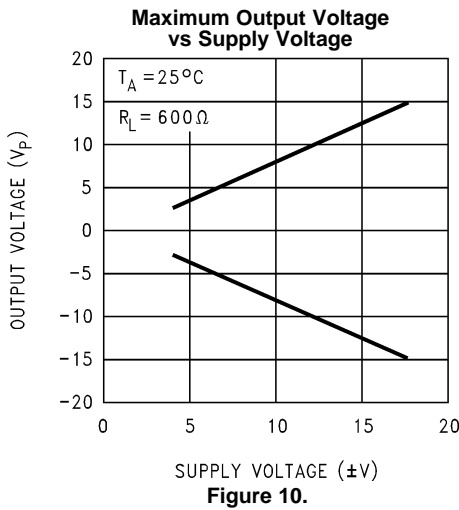

Figure 10.

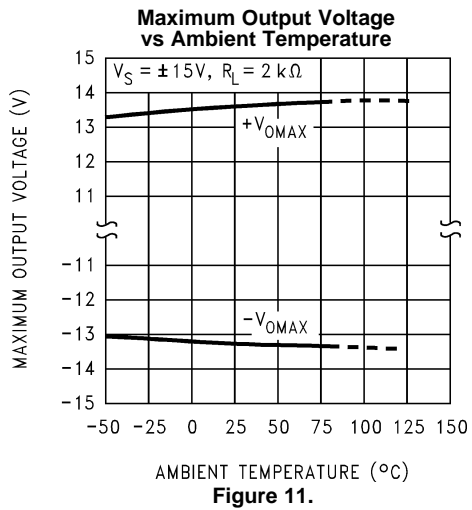

Figure 11.

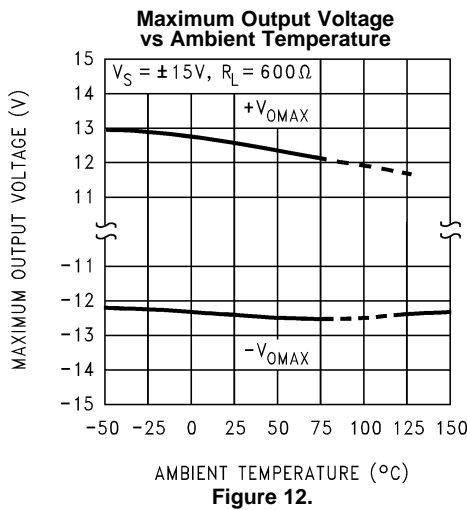

Figure 12.

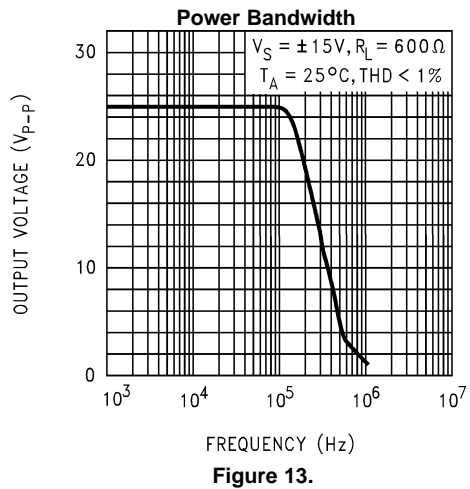
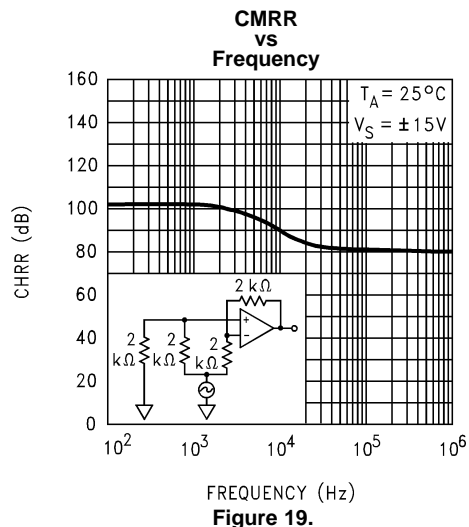
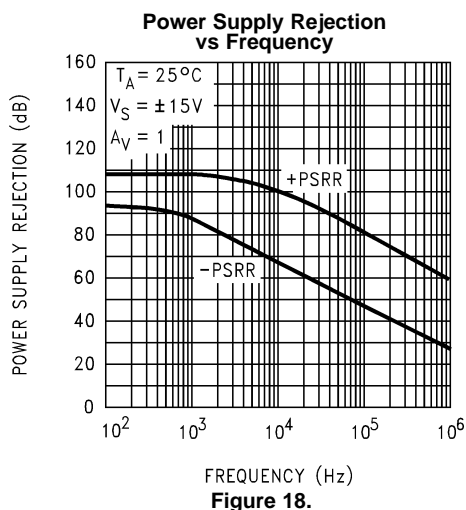
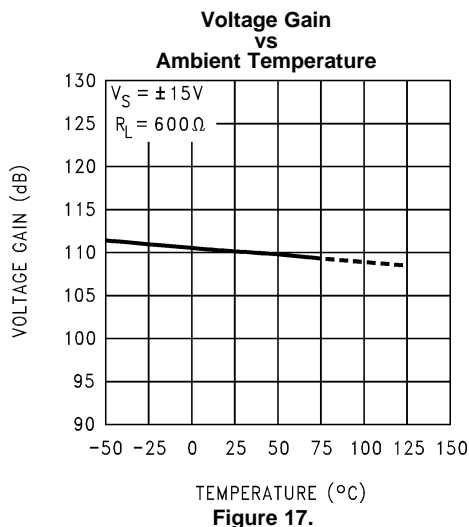
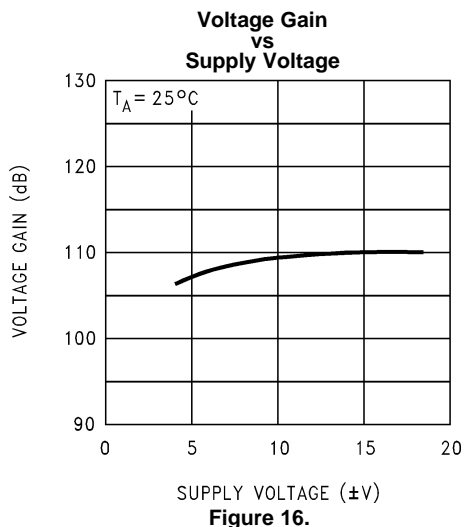
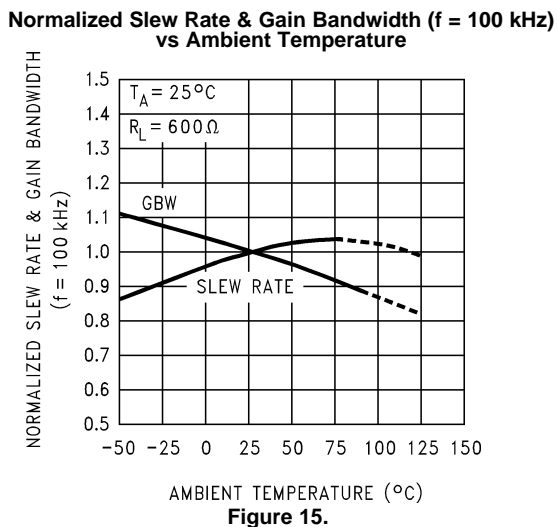
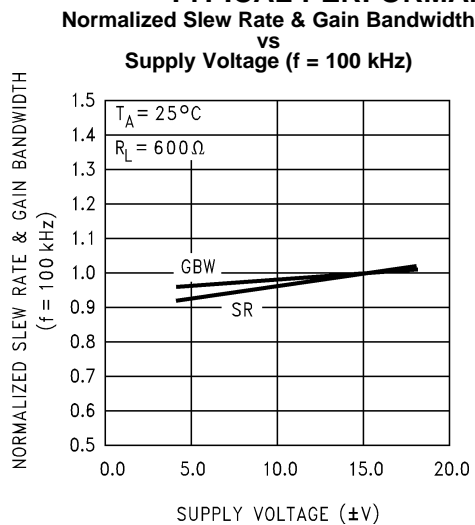

Figure 13.

TYPICAL PERFORMANCE CHARACTERISTICS (continued)



TYPICAL PERFORMANCE CHARACTERISTICS (continued)

Open Loop Gain & Phase vs Frequency

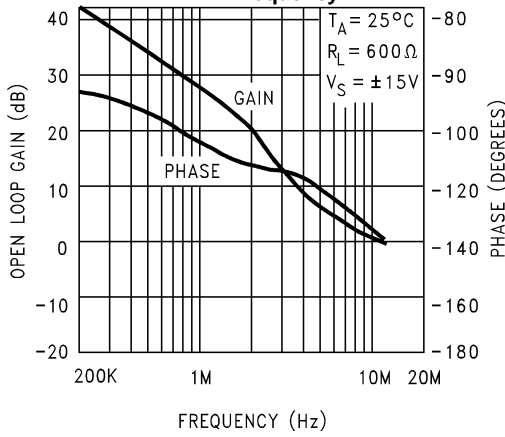

Figure 20.

Total Harmonic Distortion vs Frequency

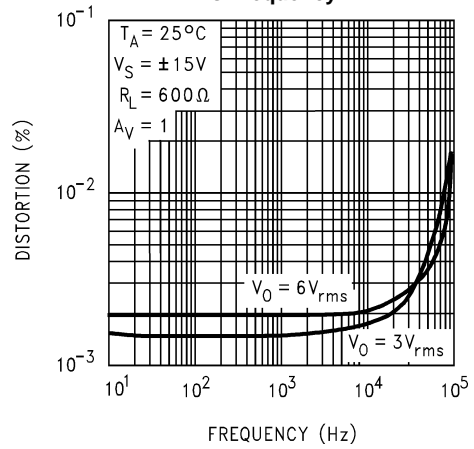

Figure 21.

Equivalent Input Noise Voltage vs Frequency

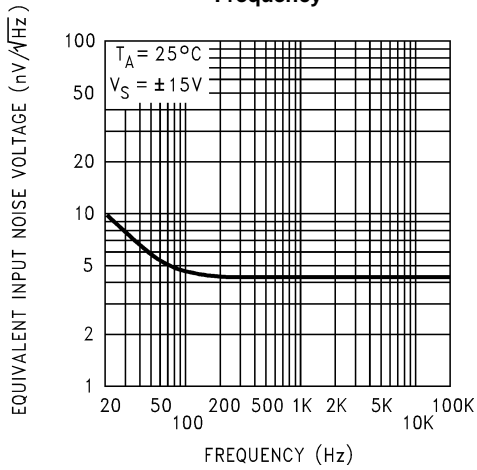

Figure 22.

Equivalent Input Noise Current vs Frequency

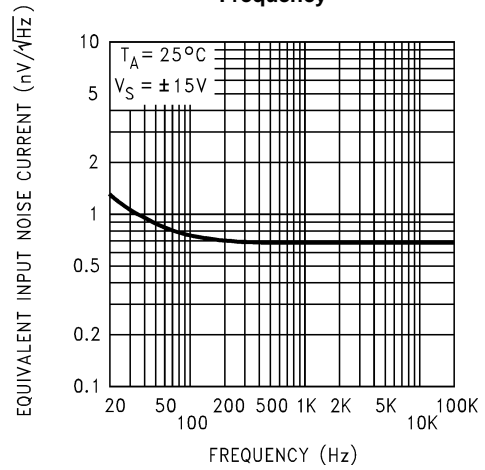

Figure 23.

Small Signal, Non-Inverting
 $T_A = 25^\circ\text{C}$, $A_V = 1$, $R_L = 600\Omega$, $V_S = \pm 15\text{V}$

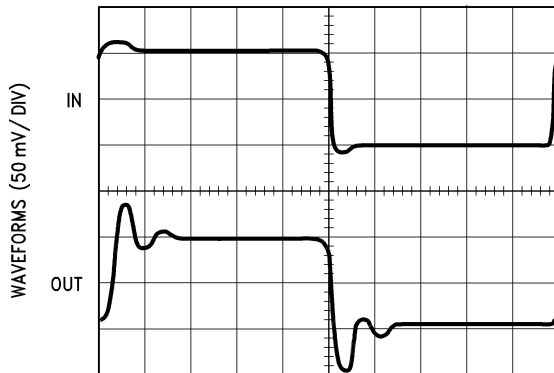

Figure 24.

Current Limit
 $T_A = 25^\circ\text{C}$, $V_S = \pm 15\text{V}$, $R_L = 100\Omega$, $A_V = 1$

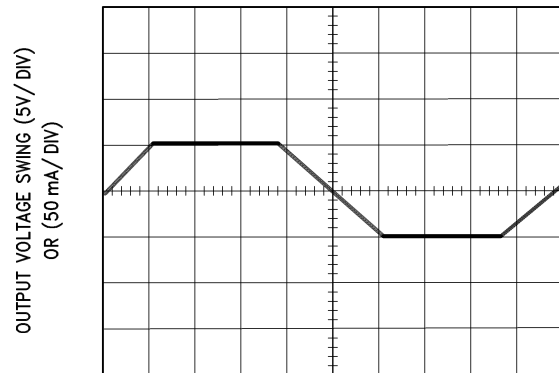
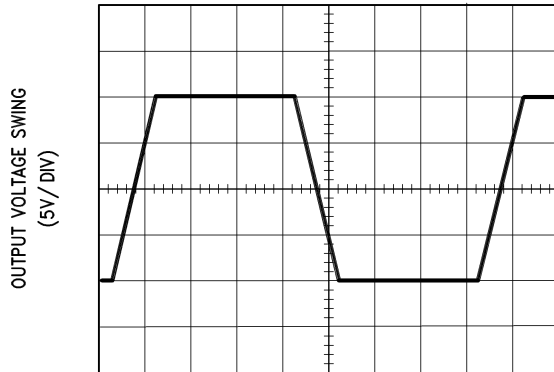

Figure 25.

TYPICAL PERFORMANCE CHARACTERISTICS (continued)

Large Signal Non-Inverting
 $T_A = 25^\circ\text{C}$, $R_L = 600\Omega$, $V_S = \pm 15\text{V}$



TIME ($1 \mu\text{s} / \text{DIV}$)
Figure 26.

Large Signal Inverting
 $T_A = 25^\circ\text{C}$, $R_L = 600\Omega$, $V_S = \pm 15\text{V}$

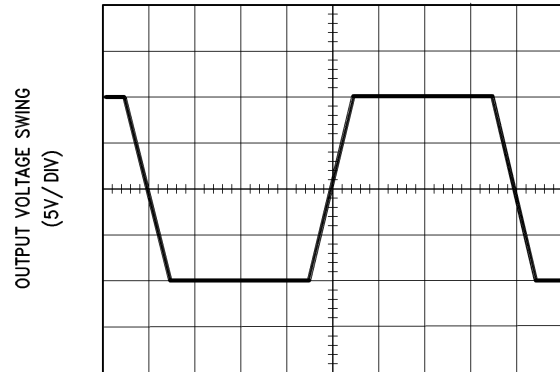

TIME ($1 \mu\text{s} / \text{DIV}$)
Figure 27.

REVISION HISTORY

Changes from Revision B (March 2013) to Revision C	Page
• Changed layout of National Data Sheet to TI format	5

PACKAGING INFORMATION

Orderable Device	Status (1)	Package Type	Package Drawing	Pins	Package Qty	Eco Plan (2)	Lead/Ball Finish (6)	MSL Peak Temp (3)	Op Temp (°C)	Device Marking (4/5)	Samples
LM837MX/NOPB	ACTIVE	SOIC	D	14	2500	Green (RoHS & no Sb/Br)	CU SN	Level-1-260C-UNLIM	-40 to 85	LM837M	Samples

(1) The marketing status values are defined as follows:

ACTIVE: Product device recommended for new designs.

LIFEBUY: TI has announced that the device will be discontinued, and a lifetime-buy period is in effect.

NRND: Not recommended for new designs. Device is in production to support existing customers, but TI does not recommend using this part in a new design.

PREVIEW: Device has been announced but is not in production. Samples may or may not be available.

OBSOLETE: TI has discontinued the production of the device.

(2) Eco Plan - The planned eco-friendly classification: Pb-Free (RoHS), Pb-Free (RoHS Exempt), or Green (RoHS & no Sb/Br) - please check <http://www.ti.com/productcontent> for the latest availability information and additional product content details.

TBD: The Pb-Free/Green conversion plan has not been defined.

Pb-Free (RoHS): TI's terms "Lead-Free" or "Pb-Free" mean semiconductor products that are compatible with the current RoHS requirements for all 6 substances, including the requirement that lead not exceed 0.1% by weight in homogeneous materials. Where designed to be soldered at high temperatures, TI Pb-Free products are suitable for use in specified lead-free processes.

Pb-Free (RoHS Exempt): This component has a RoHS exemption for either 1) lead-based flip-chip solder bumps used between the die and package, or 2) lead-based die adhesive used between the die and leadframe. The component is otherwise considered Pb-Free (RoHS compatible) as defined above.

Green (RoHS & no Sb/Br): TI defines "Green" to mean Pb-Free (RoHS compatible), and free of Bromine (Br) and Antimony (Sb) based flame retardants (Br or Sb do not exceed 0.1% by weight in homogeneous material)

(3) MSL, Peak Temp. - The Moisture Sensitivity Level rating according to the JEDEC industry standard classifications, and peak solder temperature.

(4) There may be additional marking, which relates to the logo, the lot trace code information, or the environmental category on the device.

(5) Multiple Device Markings will be inside parentheses. Only one Device Marking contained in parentheses and separated by a "~" will appear on a device. If a line is indented then it is a continuation of the previous line and the two combined represent the entire Device Marking for that device.

(6) Lead/Ball Finish - Orderable Devices may have multiple material finish options. Finish options are separated by a vertical ruled line. Lead/Ball Finish values may wrap to two lines if the finish value exceeds the maximum column width.

Important Information and Disclaimer: The information provided on this page represents TI's knowledge and belief as of the date that it is provided. TI bases its knowledge and belief on information provided by third parties, and makes no representation or warranty as to the accuracy of such information. Efforts are underway to better integrate information from third parties. TI has taken and continues to take reasonable steps to provide representative and accurate information but may not have conducted destructive testing or chemical analysis on incoming materials and chemicals. TI and TI suppliers consider certain information to be proprietary, and thus CAS numbers and other limited information may not be available for release.

In no event shall TI's liability arising out of such information exceed the total purchase price of the TI part(s) at issue in this document sold by TI to Customer on an annual basis.

TAPE AND REEL INFORMATION



QUADRANT ASSIGNMENTS FOR PIN 1 ORIENTATION IN TAPE



*All dimensions are nominal

Device	Package Type	Package Drawing	Pins	SPQ	Reel Diameter (mm)	Reel Width W1 (mm)	A0 (mm)	B0 (mm)	K0 (mm)	P1 (mm)	W (mm)	Pin1 Quadrant
LM837MX/NOPB	SOIC	D	14	2500	330.0	16.4	6.5	9.35	2.3	8.0	16.0	Q1

TAPE AND REEL BOX DIMENSIONS



*All dimensions are nominal

Device	Package Type	Package Drawing	Pins	SPQ	Length (mm)	Width (mm)	Height (mm)
LM837MX/NOPB	SOIC	D	14	2500	367.0	367.0	35.0

D (R-PDSO-G14)

PLASTIC SMALL OUTLINE



- NOTES:
- All linear dimensions are in millimeters.
 - This drawing is subject to change without notice.
 - Publication IPC-7351 is recommended for alternate designs.
 - Laser cutting apertures with trapezoidal walls and also rounding corners will offer better paste release. Customers should contact their board assembly site for stencil design recommendations. Refer to IPC-7525 for other stencil recommendations.
 - Customers should contact their board fabrication site for solder mask tolerances between and around signal pads.

IMPORTANT NOTICE AND DISCLAIMER

TI PROVIDES TECHNICAL AND RELIABILITY DATA (INCLUDING DATASHEETS), DESIGN RESOURCES (INCLUDING REFERENCE DESIGNS), APPLICATION OR OTHER DESIGN ADVICE, WEB TOOLS, SAFETY INFORMATION, AND OTHER RESOURCES "AS IS" AND WITH ALL FAULTS, AND DISCLAIMS ALL WARRANTIES, EXPRESS AND IMPLIED, INCLUDING WITHOUT LIMITATION ANY IMPLIED WARRANTIES OF MERCHANTABILITY, FITNESS FOR A PARTICULAR PURPOSE OR NON-INFRINGEMENT OF THIRD PARTY INTELLECTUAL PROPERTY RIGHTS.



These resources are intended for skilled developers designing with TI products. You are solely responsible for (1) selecting the appropriate TI products for your application, (2) designing, validating and testing your application, and (3) ensuring your application meets applicable standards, and any other safety, security, or other requirements. These resources are subject to change without notice. TI grants you permission to use these resources only for development of an application that uses the TI products described in the resource. Other reproduction and display of these resources is prohibited. No license is granted to any other TI intellectual property right or to any third party intellectual property right. TI disclaims responsibility for, and you will fully indemnify TI and its representatives against, any claims, damages, costs, losses, and liabilities arising out of your use of these resources.

TI's products are provided subject to TI's Terms of Sale (www.ti.com/legal/termsofsale.html) or other applicable terms available either on ti.com or provided in conjunction with such TI products. TI's provision of these resources does not expand or otherwise alter TI's applicable warranties or warranty disclaimers for TI products.

Mailing Address: Texas Instruments, Post Office Box 655303, Dallas, Texas 75265
Copyright © 2019, Texas Instruments Incorporated

Looking for pricing, stock, or lifecycle information?

Click below to explore more details on WIN SOURCE:

-  [View LM837MX/NOPB on WIN SOURCE](#)
-  [Texas Instruments](#) Information

Optimize Your Supply Chain with WIN SOURCE Solutions

-  Global Sourcing Solution
-  Obsolete Management
-  Cost Control Management
-  Shortage Management
-  Alternative Solution
-  Excess Inventory Management