



2SB1202/2SD1802

Bipolar Transistor (-50V, (-)3A, Low VCE(sat) (PNP)NPN Single TP/TP-FA

ON Semiconductor®

<http://onsemi.com>

Applications

- Voltage regulators, relay drivers, lamp drivers, electrical equipment

Features

- Adoption of FBET and MBIT processes
- Low collector to emitter saturation voltage
- Small and slim package making it easy to make 2SB1202/2SD1802-used sets smaller
- Large current capacitance and wide ASO
- Fast switching speed

Specifications () : 2SB1202

Absolute Maximum Ratings at Ta=25°C

| Parameter | Symbol | Conditions | Ratings | Unit |
|------------------------------|------------------|------------|---------|------|
| Collector to Base Voltage | V _{CB0} | | (-)60 | V |
| Collector to Emitter Voltage | V _{CE0} | | (-)50 | V |
| Emitter to Base Voltage | V _{EB0} | | (-)6 | V |
| Collector Current | I _C | | (-)3 | A |
| Collector Current (Pulse) | I _{CP} | | (-)6 | A |

Continued on next page.

Stresses exceeding Maximum Ratings may damage the device. Maximum Ratings are stress ratings only. Functional operation above the Recommended Operating Conditions is not implied. Extended exposure to stresses above the Recommended Operating Conditions may affect device reliability.

Package Dimensions unit : mm (typ)

7518-003

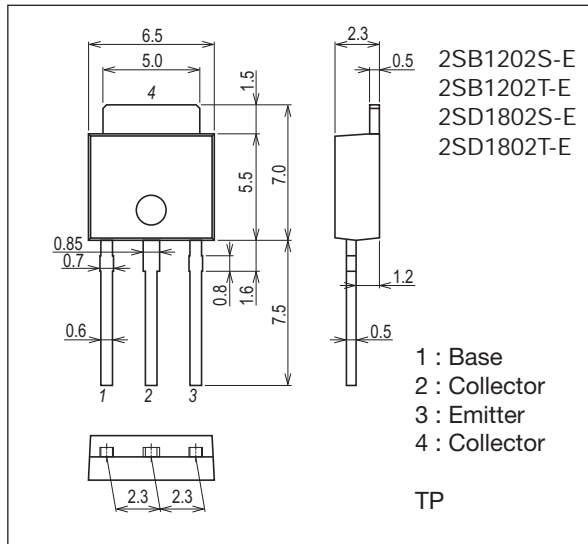

Package Dimensions unit : mm (typ)

7003-003

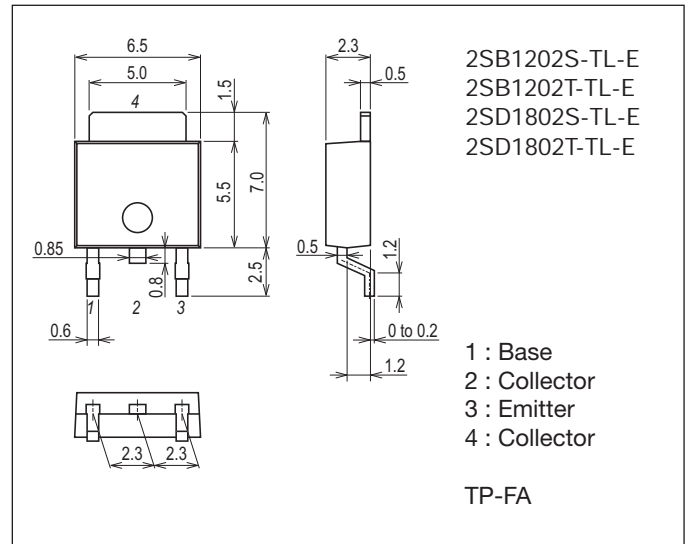

Product & Package Information

- Package : TP
- JEITA, JEDEC : SC-64, TO-251, SOT-553, DPAK
- Minimum Packing Quantity : 500 pcs./bag

- Package : TP-FA
- JEITA, JEDEC : SC-63, TO-252, SOT-428, DPAK
- Minimum Packing Quantity : 700 pcs./reel

Marking (TP, TP-FA)

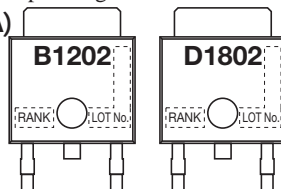

Packing Type (TP-FA) : TL

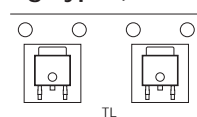

Electrical Connection

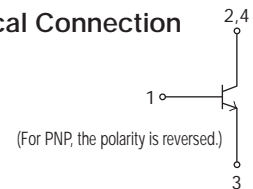

2SB1202/2SD1802

Continued from preceding page.

| Parameter | Symbol | Conditions | Ratings | Unit |
|-----------------------|------------------|----------------------|-------------|------|
| Collector Dissipation | PC | | 1 | W |
| | | T _c =25°C | 15 | W |
| Junction Temperature | T _j | | 150 | °C |
| Storage Temperature | T _{stg} | | -55 to +150 | °C |

Electrical Characteristics at T_a=25°C

| Parameter | Symbol | Conditions | Ratings | | | Unit | |
|---|----------------------|--|---------|-------------|-----------|------|----|
| | | | min | typ | max | | |
| Collector Cutoff Current | I _{CBO} | V _{CB} =(-)40V, I _E =0A | | | (-)1 | μA | |
| Emitter Cutoff Current | I _{EBO} | V _{EB} =(-)4V, I _C =0A | | | (-)1 | μA | |
| DC Current Gain | h _{FE1} | V _{CE} =(-)2V, I _C =(-)100mA | 100* | | 560* | | |
| | h _{FE2} | V _{CE} =(-)2V, I _C =(-)3A | 35 | | | | |
| Gain-Bandwidth Product | f _T | V _{CE} =(-)10V, I _C =(-)50mA | | 150 | | MHz | |
| Output Capacitance | C _{ob} | V _{CB} =(-)10V, f=1MHz | | (39)25 | | pF | |
| Collector to Emitter Saturation Voltage | V _{CE(sat)} | I _C =(-)2A, I _B =(-)100mA | | (-0.35)0.19 | (-0.7)0.5 | mV | |
| Base to Emitter Saturation Voltage | V _{BE(sat)} | V _{CE} =(-)2V, I _C =(-)100mA | | (-)0.94 | (-)1.2 | V | |
| Collector to Base Breakdown Voltage | V(BR)CBO | I _C =(-)10μA, I _E =0A | (-)60 | | | V | |
| Collector to Emitter Breakdown Voltage | V(BR)CEO | I _C =(-)1mA, R _{BE} =∞ | (-)50 | | | V | |
| Emitter to Base Breakdown Voltage | V(BR)EBO | I _E =(-)10μA, I _C =0A | (-)6 | | | V | |
| Turn-On Time | t _{on} | See specified Test Circuit. | | 70 | | ns | |
| Storage Time | t _{stg} | | | (450)650 | | | ns |
| Fall Time | t _f | | | 35 | | | ns |

* : The 2SB1202/2SD1802 are classified by 100mA hFE as follows :

| Rank | R | S | T | U |
|------|------------|------------|------------|------------|
| hFE | 100 to 200 | 140 to 280 | 200 to 400 | 280 to 560 |

Switching Time Test Circuit

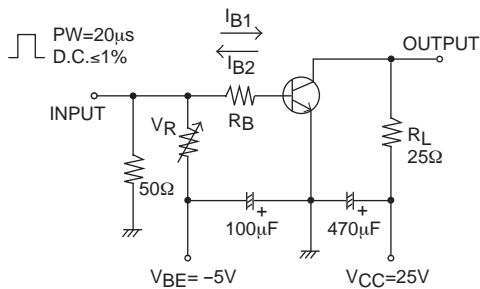

$$I_C = 10I_{B1} = -10I_{B2} = 1A$$

For PNP, the polarity is reversed.

Ordering Information

| Device | Package | Shipping | memo |
|---------------|---------|--------------|---------|
| 2SB1202S-E | TP | 500pcs./bag | Pb Free |
| 2SB1202T-E | TP | 500pcs./bag | |
| 2SD1802S-E | TP | 500pcs./bag | |
| 2SD1802T-E | TP | 500pcs./bag | |
| 2SB1202S-TL-E | TP-FA | 700pcs./reel | |
| 2SB1202T-TL-E | TP-FA | 700pcs./reel | |
| 2SD1802S-TL-E | TP-FA | 700pcs./reel | |
| 2SD1802T-TL-E | TP-FA | 700pcs./reel | |

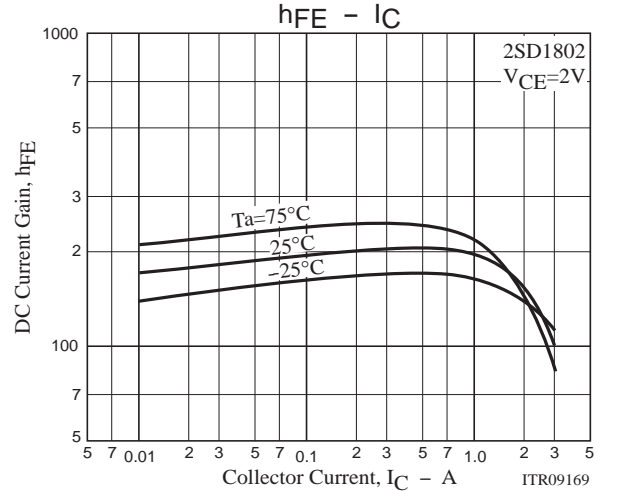
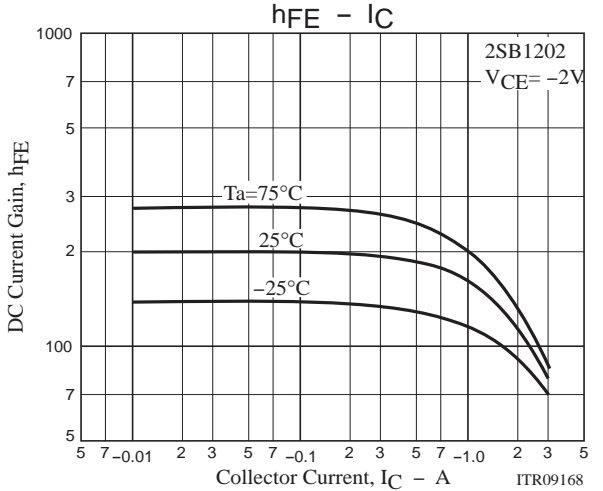
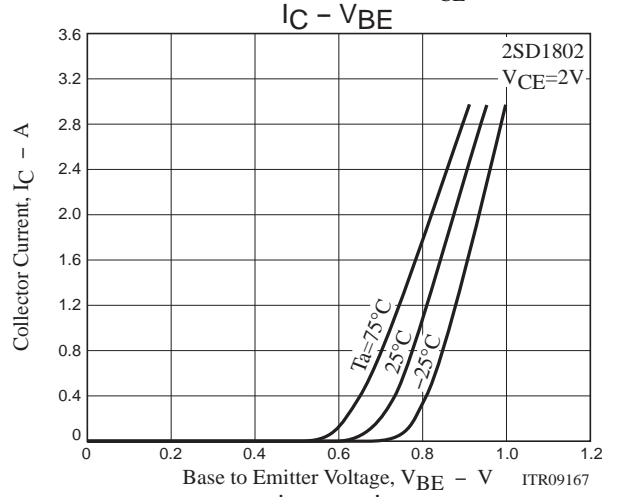
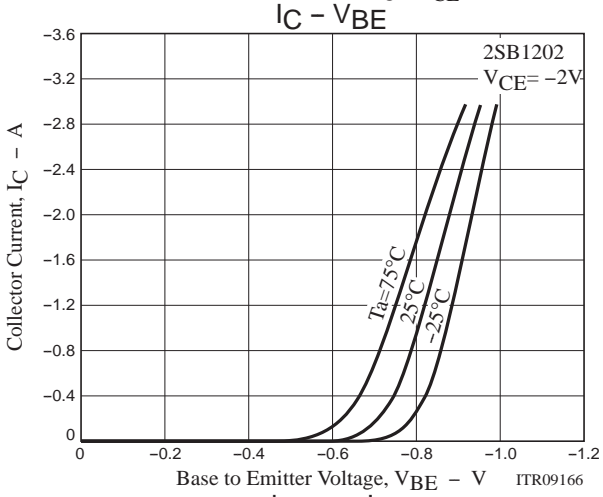
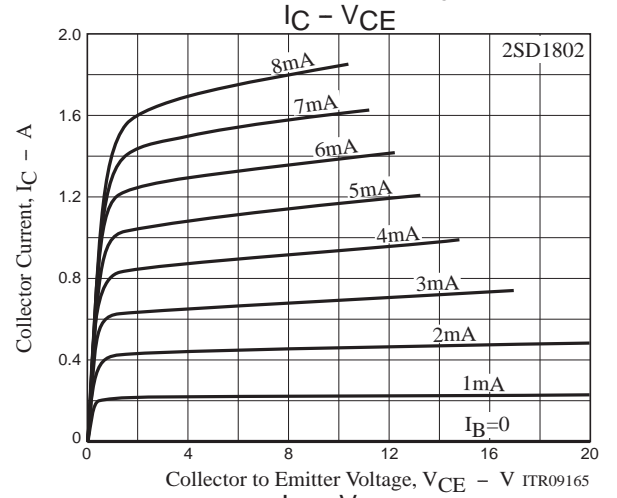
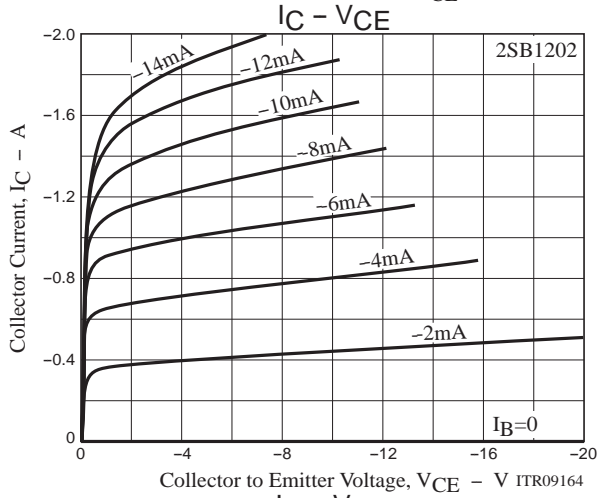
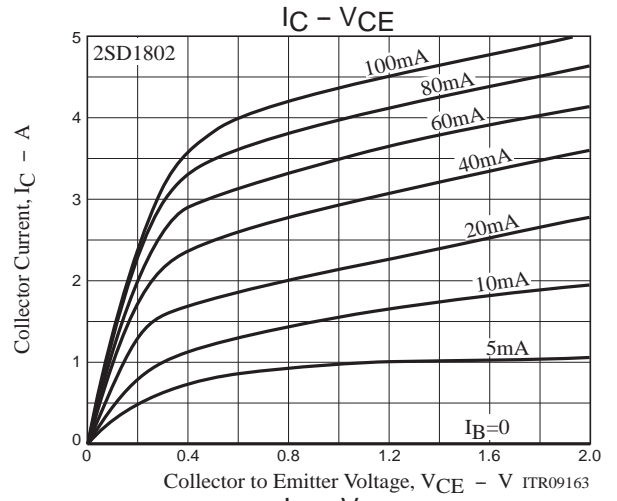
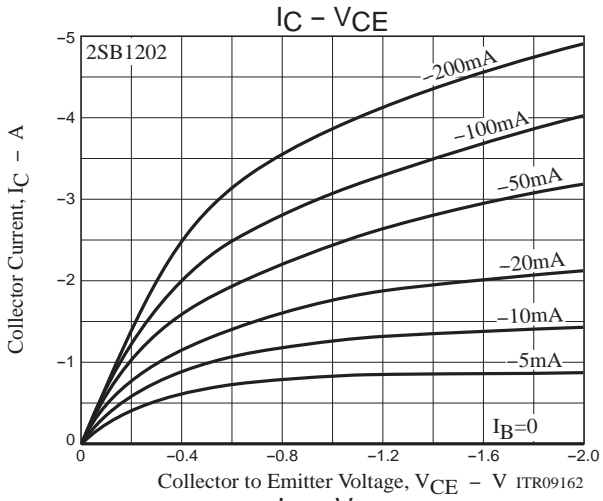

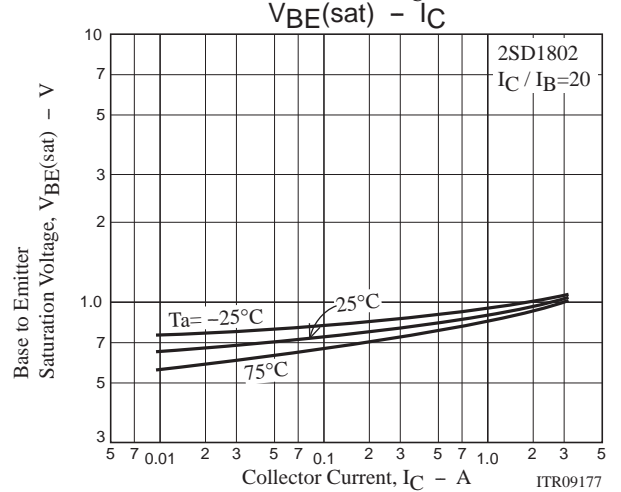
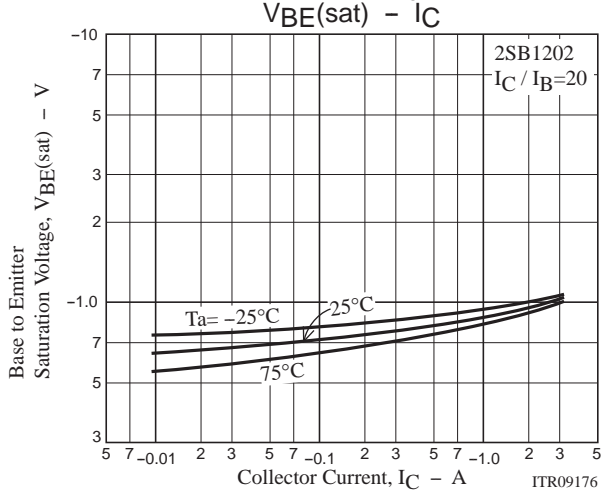
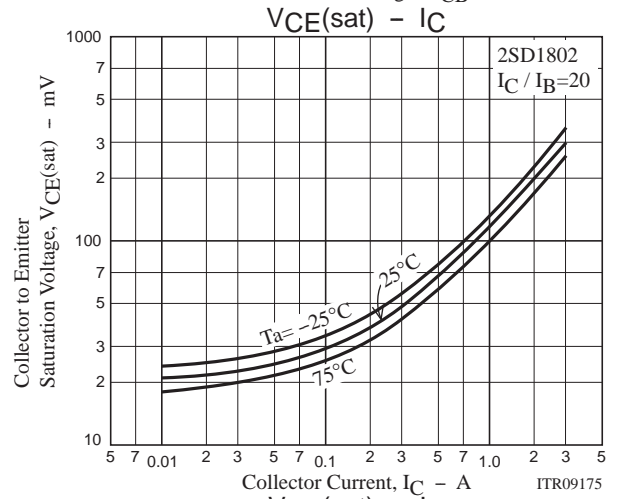
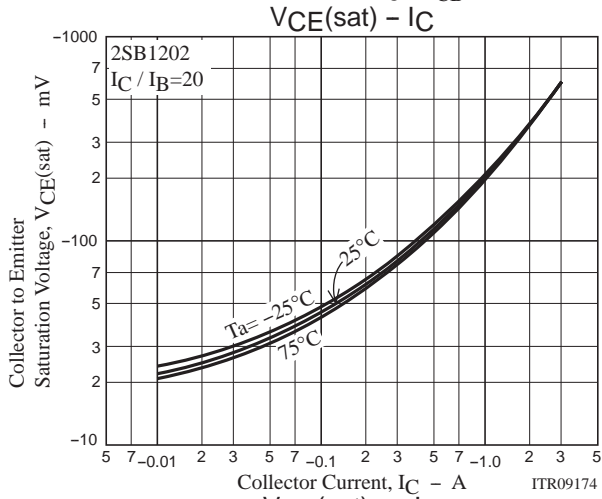
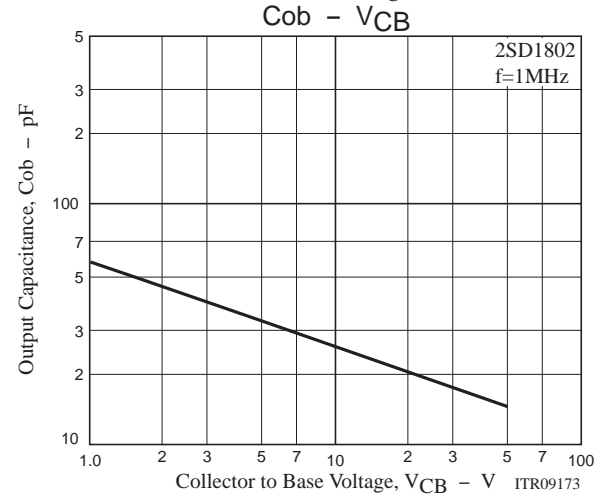
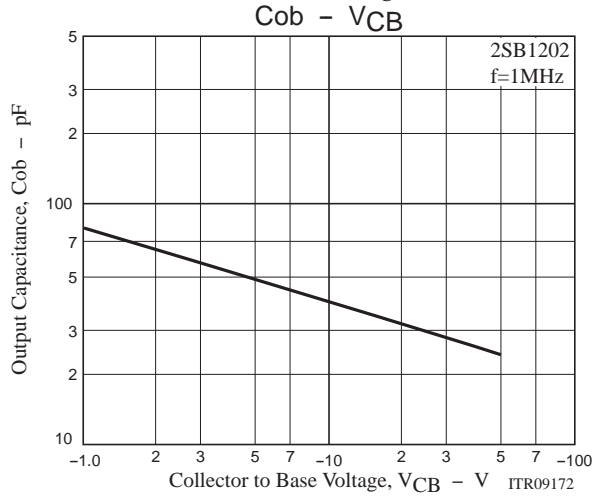
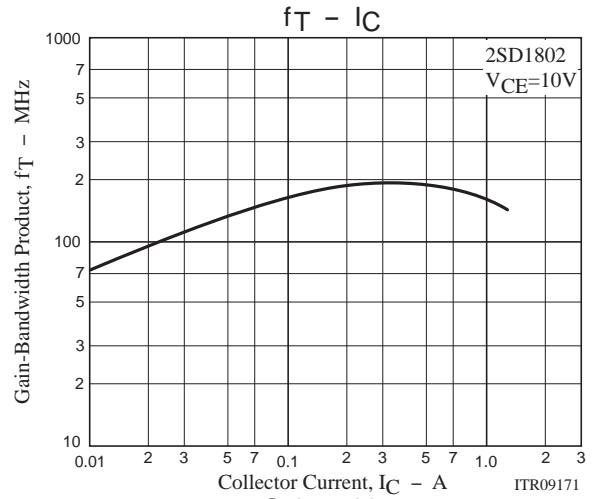
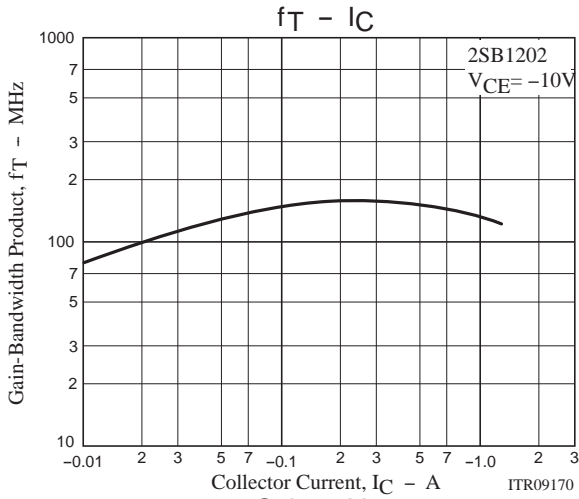

2SB1202/2SD1802

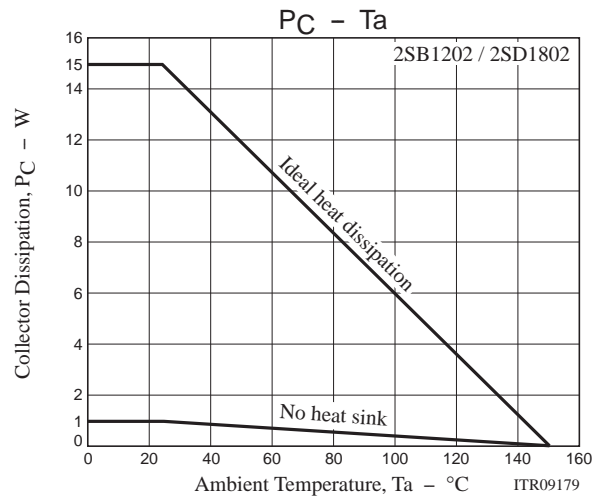
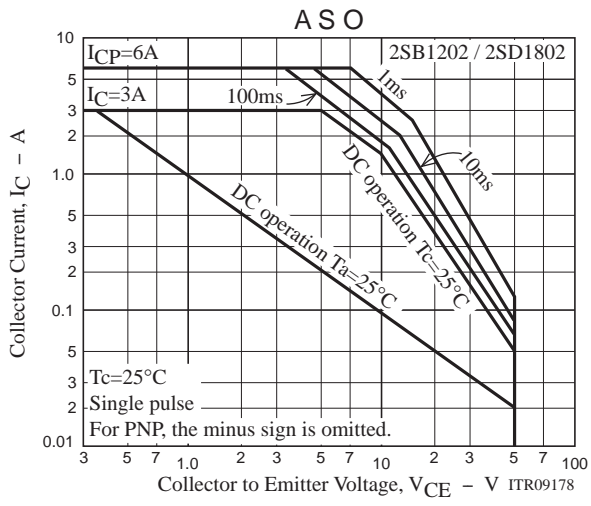

2SB1202/2SD1802

Outline Drawing

Land Pattern Example

2SB1202S-TL-E, 2SB1202T-TL-E, 2SD1802S-TL-E, 2SD1802T-TL-E

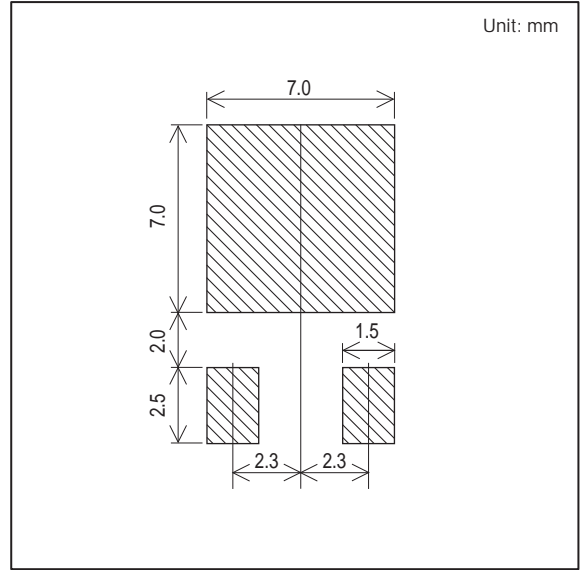
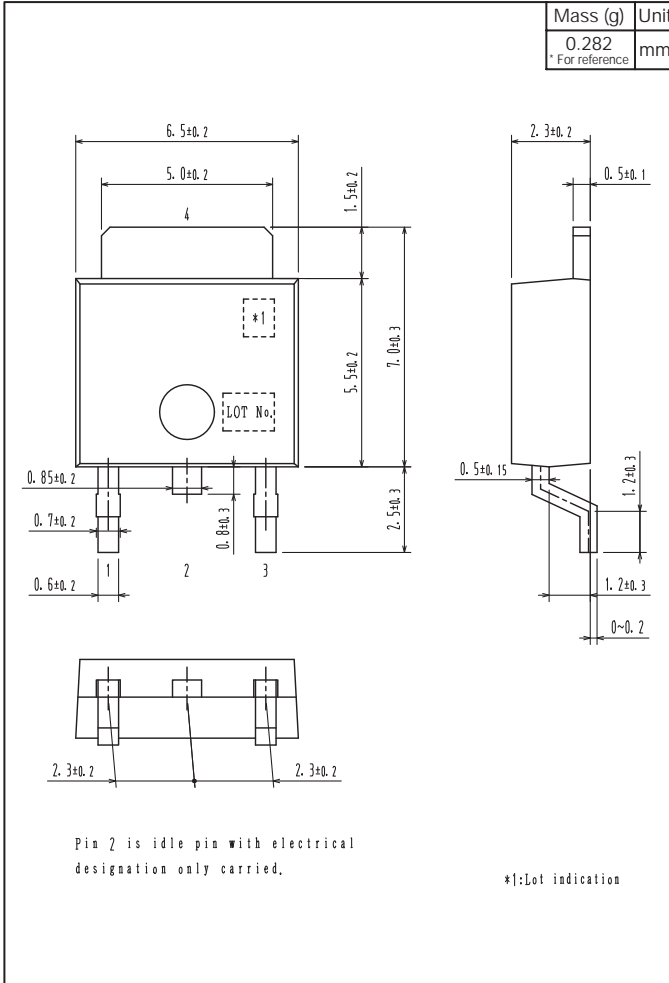

Outline Drawing

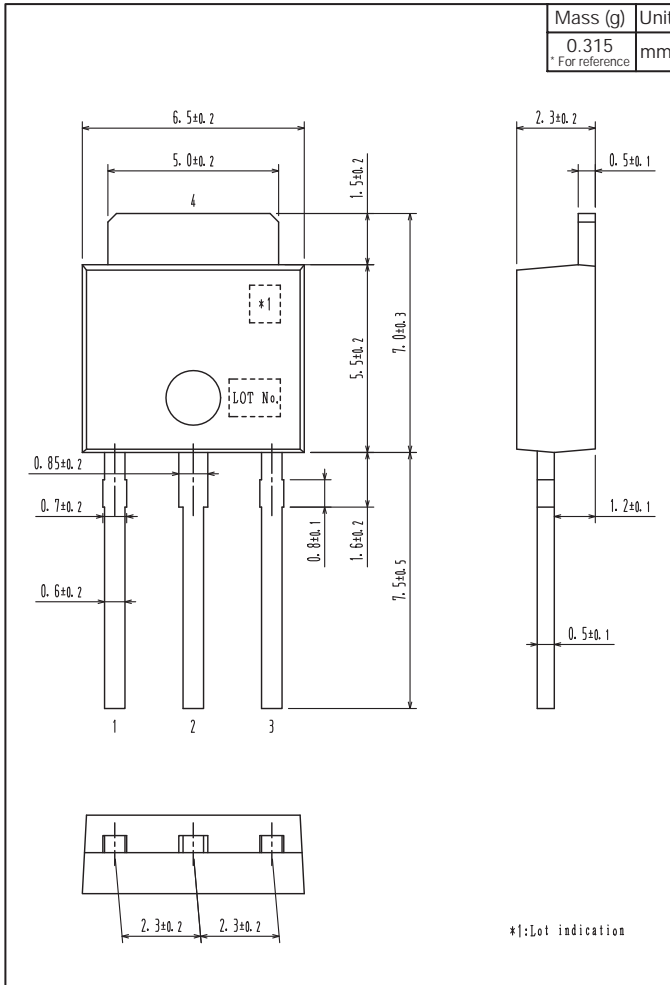

2SB1202S-E, 2SB1202T-E, 2SD1802S-E, 2SD1802T-E



ON Semiconductor and the ON logo are registered trademarks of Semiconductor Components Industries, LLC (SCILLC). SCILLC owns the rights to a number of patents, trademarks, copyrights, trade secrets, and other intellectual property. A listing of SCILLC's product/patent coverage may be accessed at www.onsemi.com/site/pdf/Patent-Marking.pdf. SCILLC reserves the right to make changes without further notice to any products herein. SCILLC makes no warranty, representation or guarantee regarding the suitability of its products for any particular purpose, nor does SCILLC assume any liability arising out of the application or use of any product or circuit, and specifically disclaims any and all liability, including without limitation special, consequential or incidental damages. "Typical" parameters which may be provided in SCILLC data sheets and/or specifications can and do vary in different applications and actual performance may vary over time. All operating parameters, including "Typicals" must be validated for each customer application by customer's technical experts. SCILLC does not convey any license under its patent rights nor the rights of others. SCILLC products are not designed, intended, or authorized for use as components in systems intended for surgical implant into the body, or other applications intended to support or sustain life, or for any other application in which the failure of the SCILLC product could create a situation where personal injury or death may occur. Should Buyer purchase or use SCILLC products for any such unintended or unauthorized application, Buyer shall indemnify and hold SCILLC and its officers, employees, subsidiaries, affiliates, and distributors harmless against all claims, costs, damages, and expenses, and reasonable attorney fees arising out of, directly or indirectly, any claim of personal injury or death associated with such unintended or unauthorized use, even if such claim alleges that SCILLC was negligent regarding the design or manufacture of the part. SCILLC is an Equal Opportunity/Affirmative Action Employer. This literature is subject to all applicable copyright laws and is not for resale in any manner.

Looking for pricing, stock, or lifecycle information?

Click below to explore more details on WIN SOURCE:

-  [View 2SB1202T-TL on WIN SOURCE](#)
-  [ON Semiconductor](#) Information

Optimize Your Supply Chain with WIN SOURCE Solutions

-  Global Sourcing Solution
-  Obsolete Management
-  Cost Control Management
-  Shortage Management
-  Alternative Solution
-  Excess Inventory Management