



# THE DATASHEET OF LMC6035ITL/NOPB



# LMC6035/LMC6035-Q1/LMC6036 Low Power 2.7V Single Supply CMOS Operational Amplifiers

 Check for Samples: [LMC6035](#), [LMC6036](#)

## FEATURES

- (Typical Unless Otherwise Noted)
- LMC6035 in DSBGA Package
- Ensured 2.7V, 3V, 5V and 15V Performance
- Specified for 2 k $\Omega$  and 600 $\Omega$  Loads
- Wide Operating Range: 2.0V to 15.5V
- Ultra Low Input Current: 20fA
- Rail-to-Rail Output Swing
  - @ 600 $\Omega$ : 200mV from Either Rail at 2.7V
  - @ 100k $\Omega$ : 5mV from Either Rail at 2.7V
- High Voltage Gain: 126dB
- Wide Input Common-Mode Voltage Range
  - -0.1V to 2.3V at  $V_S = 2.7V$
- Low Distortion: 0.01% at 10kHz
- LMC6035 Dual LMC6036 Quad
- See AN-1112 (Literature Number [SNVA009](#)) for DSBGA Considerations
- AEC-Q100 Grade 3 Qualified (LMC6035-Q1)

## APPLICATIONS

- Filters
- High Impedance Buffer or Preamplifier
- Battery Powered Electronics
- Medical Instrumentation
- Automotive Applications

## DESCRIPTION

The LMC6035/6 is an economical, low voltage op amp capable of rail-to-rail output swing into loads of 600 $\Omega$ . LMC6035 is available in a chip sized package (8-Bump DSBGA) using micro SMD package technology. Both allow for single supply operation and are ensured for 2.7V, 3V, 5V and 15V supply voltage. The 2.7 supply voltage corresponds to the End-of-Life voltage (0.9V/cell) for three NiCd or NiMH batteries in series, making the LMC6035/6 well suited for portable and rechargeable systems. It also features a well behaved decrease in its specifications at supply voltages below its ensured 2.7V operation. This provides a “comfort zone” for adequate operation at voltages significantly below 2.7V. Its ultra low input currents ( $I_{IN}$ ) makes it well suited for low power active filter application, because it allows the use of higher resistor values and lower capacitor values. In addition, the drive capability of the LMC6035/6 gives these op amps a broad range of applications for low voltage systems.

## Connection Diagram

Top View

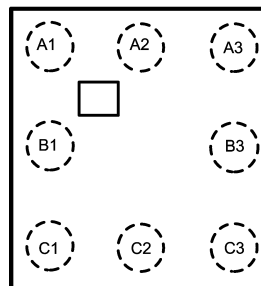

**Figure 1. 8-Bump DSBGA Package  
(Bump Side Down)  
See Package Number YZR0008**



Please be aware that an important notice concerning availability, standard warranty, and use in critical applications of Texas Instruments semiconductor products and disclaimers thereto appears at the end of this data sheet.

All trademarks are the property of their respective owners.

**Table 1. DSBGA Connection Table**

Bump Number	LM6035IBP LMC6035IBPX	LMC6035ITL LMC6035ITLX
A1	OUTPUT A	OUTPUT B
B1	IN A <sup>-</sup>	V <sup>+</sup>
C1	IN A <sup>+</sup>	OUTPUT A
C2	V <sup>-</sup>	IN A <sup>-</sup>
C3	IN B <sup>+</sup>	IN A <sup>+</sup>
B3	IN B <sup>-</sup>	V <sup>-</sup>
A3	OUTPUT B	IN B <sup>+</sup>
A2	V <sup>+</sup>	IN B <sup>-</sup>



These devices have limited built-in ESD protection. The leads should be shorted together or the device placed in conductive foam during storage or handling to prevent electrostatic damage to the MOS gates.

**Absolute Maximum Ratings<sup>(1)(2)</sup>**

ESD Tolerance <sup>(3)</sup>	Human Body Model (LMC6035, LMC6036)	3000V
	Human Body Model (LMC6035-Q1)	2000V
	Machine Model	300V
Differential Input Voltage		± Supply Voltage
Supply Voltage (V <sup>+</sup> – V <sup>-</sup> )		16V
Output Short Circuit to V <sup>+</sup>		See <sup>(4)</sup>
Output Short Circuit to V <sup>-</sup>		See <sup>(5)</sup>
Lead Temperature (soldering, 10 sec.)		260°C
Current at Output Pin		±18mA
Current at Input Pin		±5mA
Current at Power Supply Pin		35mA
Storage Temperature Range		-65°C to +150°C
Junction Temperature <sup>(6)</sup>		150°C

- (1) Absolute Maximum Ratings indicate limits beyond which damage to the device may occur. Operating Ratings indicate conditions for which the device is intended to be functional, but specific performance is not ensured. For ensured specifications and the test conditions, see the Electrical Characteristics.
- (2) If Military/Aerospace specified devices are required, please contact the TI Sales Office/ Distributors for availability and specifications.
- (3) Human body model, 1.5kΩ in series with 100pF.
- (4) Do not short circuit output to V<sup>+</sup> when V<sup>+</sup> is greater than 13V or reliability will be adversely affected.
- (5) Applies to both single-supply and split-supply operation. Continuous short circuit operation at elevated ambient temperature can result in exceeding the maximum allowed junction temperature of 150°C. Output currents in excess of 30mA over long term may adversely affect reliability.
- (6) The maximum power dissipation is a function of T<sub>J(MAX)</sub>, θ<sub>JA</sub>, and T<sub>A</sub>. The maximum allowable power dissipation at any ambient temperature is P<sub>D</sub> = (T<sub>J(MAX)</sub> – T<sub>A</sub>)/θ<sub>JA</sub>. All numbers apply for packages soldered directly onto a PC board with no air flow.

**Operating Ratings<sup>(1)</sup>**

Supply Voltage		2.0V to 15.5V
Temperature Range	LMC6035I and LMC6036I	-40°C ≤ T <sub>J</sub> ≤ +85°C
Thermal Resistance (θ <sub>JA</sub> )	8-pin VSSOP	230°C/W
	8-pin SOIC	175°C/W
	14-pin SOIC	127°C/W
	14-pin TSSOP	137°C/W
	8-Bump (6 mil) DSBGA	220°C/W
	8-Bump (12 mil) Thin DSBGA	220°C/W

- (1) Absolute Maximum Ratings indicate limits beyond which damage to the device may occur. Operating Ratings indicate conditions for which the device is intended to be functional, but specific performance is not ensured. For ensured specifications and the test conditions, see the Electrical Characteristics.

## DC Electrical Characteristics

Unless otherwise specified, all limits ensured for  $T_J = 25^\circ\text{C}$ ,  $V^+ = 2.7\text{V}$ ,  $V^- = 0\text{V}$ ,  $V_{\text{CM}} = 1.0\text{V}$ ,  $V_O = 1.35\text{V}$  and  $R_L > 1\text{M}\Omega$ .

**Boldface** limits apply at the temperature extremes.

Parameter		Test Conditions		LMC6035/LMC6036I			Units
				Min <sup>(1)</sup>	Typ <sup>(2)</sup>	Max <sup>(1)</sup>	
$V_{\text{OS}}$	Input Offset Voltage				0.5	<b>5</b> <b>6</b>	mV
$\text{TCV}_{\text{OS}}$	Input Offset Voltage Average Drift				2.3		$\mu\text{V}/^\circ\text{C}$
$I_{\text{IN}}$	Input Current	See <sup>(3)</sup>			0.02	<b>90</b>	pA
$I_{\text{OS}}$	Input Offset Current	See <sup>(3)</sup>			0.01	<b>45</b>	PA
$R_{\text{IN}}$	Input Resistance				> 10		Tera $\Omega$
CMRR	Common Mode Rejection Ratio	$0.7\text{V} \leq V_{\text{CM}} \leq 12.7\text{V}$ , $V^+ = 15\text{V}$		<b>63</b> <b>60</b>	96		dB
+PSRR	Positive Power Supply Rejection Ratio	$5\text{V} \leq V^+ \leq 15\text{V}$ , $V_O = 2.5\text{V}$		<b>63</b> <b>60</b>	93		dB
-PSRR	Negative Power Supply Rejection Ratio	$0\text{V} \leq V^- \leq -10\text{V}$ , $V_O = 2.5\text{V}$ , $V^+ = 5\text{V}$		<b>74</b> <b>70</b>	97		dB
$V_{\text{CM}}$	Input Common-Mode Voltage Range	$V^+ = 2.7\text{V}$ For CMRR $\geq 40\text{dB}$			-0.1	<b>0.3</b> <b>0.5</b>	V
				<b>2.0</b> <b>1.7</b>	2.3		
		$V^+ = 3\text{V}$ For CMRR $\geq 40\text{dB}$			-0.3	<b>0.1</b> <b>0.3</b>	V
				<b>2.3</b> <b>2.0</b>	2.6		
		$V^+ = 5\text{V}$ For CMRR $\geq 50\text{dB}$			-0.5	<b>-0.2</b> <b>0.0</b>	V
				<b>4.2</b> <b>3.9</b>	4.5		
		$V^+ = 15\text{V}$ For CMRR $\geq 50\text{dB}$			-0.5	<b>-0.2</b> <b>0.0</b>	V
				<b>14.0</b> <b>13.7</b>	14.4		
$A_V$	Large Signal Voltage Gain <sup>(4)</sup>	$R_L = 600\Omega$	Sourcing	<b>100</b> <b>75</b>	1000		V/mV
			Sinking	<b>25</b> <b>20</b>	250		V/mV
		$R_L = 2\text{k}\Omega$	Sourcing		2000		V/mV
			Sinking		500		V/mV

(1) All limits are specified by testing or statistical analysis.

(2) Typical Values represent the most likely parametric norm or one sigma value.

(3) Ensured by design.

(4)  $V^+ = 15\text{V}$ ,  $V_{\text{CM}} = 7.5\text{V}$  and  $R_L$  connected to  $7.5\text{V}$ . For Sourcing tests,  $7.5\text{V} \leq V_O \leq 11.5\text{V}$ . For Sinking tests,  $3.5\text{V} \leq V_O \leq 7.5\text{V}$ .

### DC Electrical Characteristics (continued)

Unless otherwise specified, all limits ensured for  $T_J = 25^\circ\text{C}$ ,  $V^+ = 2.7\text{V}$ ,  $V^- = 0\text{V}$ ,  $V_{\text{CM}} = 1.0\text{V}$ ,  $V_O = 1.35\text{V}$  and  $R_L > 1\text{M}\Omega$ . **Boldface** limits apply at the temperature extremes.

Parameter		Test Conditions		LMC6035/LMC6036I			Units
				Min <sup>(1)</sup>	Typ <sup>(2)</sup>	Max <sup>(1)</sup>	
$V_O$	Output Swing	$V^+ = 2.7\text{V}$ $R_L = 600\Omega$ to $1.35\text{V}$		2.0 <b>1.8</b>	2.5		V
					0.2	0.5 <b>0.7</b>	
		$V^+ = 2.7\text{V}$ $R_L = 2\text{k}\Omega$ to $1.35\text{V}$		2.4 <b>2.2</b>	2.62		V
					0.07	0.2 <b>0.4</b>	
		$V^+ = 15\text{V}$ $R_L = 600\Omega$ to $7.5\text{V}$		13.5 <b>13.0</b>	14.5		V
					0.36	1.25 <b>1.50</b>	
		$V^+ = 15\text{V}$ , $R_L = 2\text{k}\Omega$ to $7.5\text{V}$		14.2 <b>13.5</b>	14.8		V
					0.12	0.4 <b>0.5</b>	
$I_O$	Output Current	$V_O = 0\text{V}$	Sourcing	4 <b>3</b>	8		mA
		$V_O = 2.7\text{V}$	Sinking	3 <b>2</b>	5		
$I_S$	Supply Current	LMC6035 for Both Amplifiers $V_O = 1.35\text{V}$			0.65	1.6 <b>1.9</b>	mA
		LMC6036 for All Four Amplifiers $V_O = 1.35\text{V}$			1.3	2.7 <b>3.0</b>	

### AC Electrical Characteristics

Unless otherwise specified, all limits ensured for  $T_J = 25^\circ\text{C}$ ,  $V^+ = 2.7\text{V}$ ,  $V^- = 0\text{V}$ ,  $V_{\text{CM}} = 1.0\text{V}$ ,  $V_O = 1.35\text{V}$  and  $R_L > 1\text{M}\Omega$ . **Boldface** limits apply at the temperature extremes.

Parameter		Test Conditions	Typ <sup>(1)</sup>	Units
SR	Slew Rate	See <sup>(2)</sup>	1.5	V/ $\mu\text{s}$
GBW	Gain Bandwidth Product	$V^+ = 15\text{V}$	1.4	MHz
$\theta_m$	Phase Margin		48	°
$G_m$	Gain Margin		17	dB
	Amp-to-Amp Isolation	See <sup>(3)</sup>	130	dB
$e_n$	Input-Referred Voltage Noise	$f = 1\text{kHz}$ $V_{\text{CM}} = 1\text{V}$	27	nV/ $\sqrt{\text{Hz}}$
$i_n$	Input Referred Current Noise	$f = 1\text{kHz}$	0.2	fA/ $\sqrt{\text{Hz}}$
THD	Total Harmonic Distortion	$f = 10\text{kHz}$ , $A_V = -10$ $R_L = 2\text{k}\Omega$ , $V_O = 8\text{V}_{\text{PP}}$ $V^+ = 10\text{V}$	0.01	%

- (1) Typical Values represent the most likely parametric norm or one sigma value.
- (2)  $V^+ = 15\text{V}$ . Connected as voltage follower with 10V step input. Number specified is the slower of the positive and negative slew rates.
- (3) Input referred,  $V^+ = 15\text{V}$  and  $R_L = 100\text{k}\Omega$  connected to  $7.5\text{V}$ . Each amp excited in turn with 1kHz to produce  $V_O = 12\text{V}_{\text{PP}}$ .

**Typical Performance Characteristics**

Unless otherwise specified,  $V_S = 2.7V$ , single supply,  $T_A = 25^\circ C$

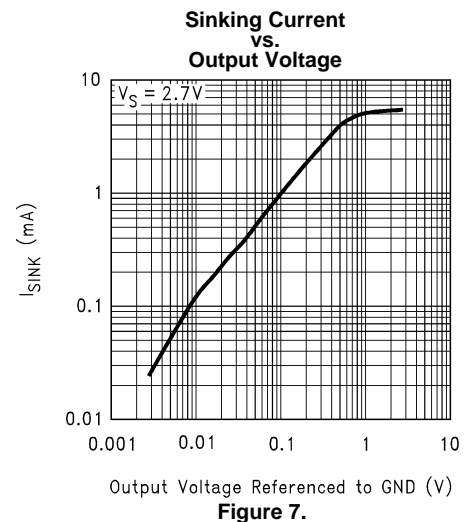
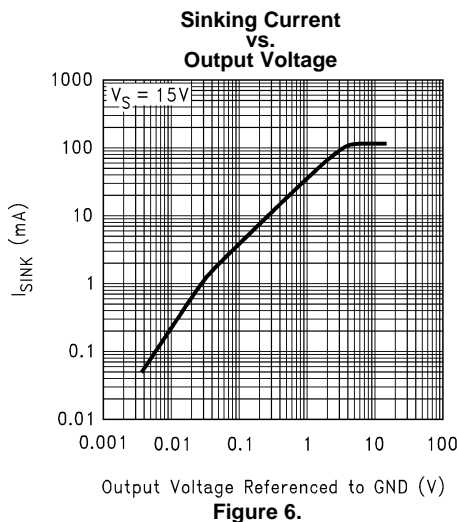
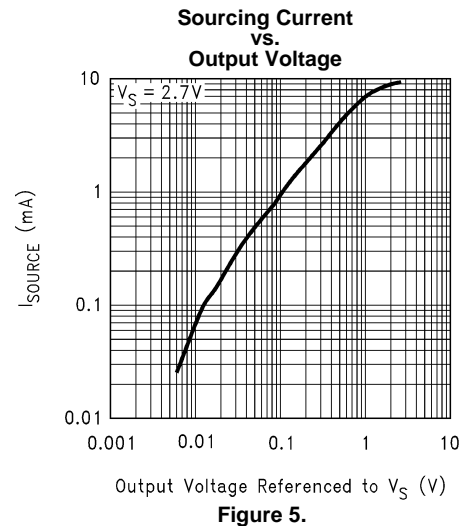
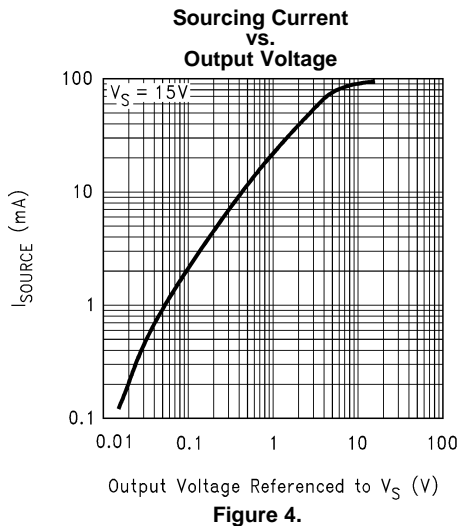
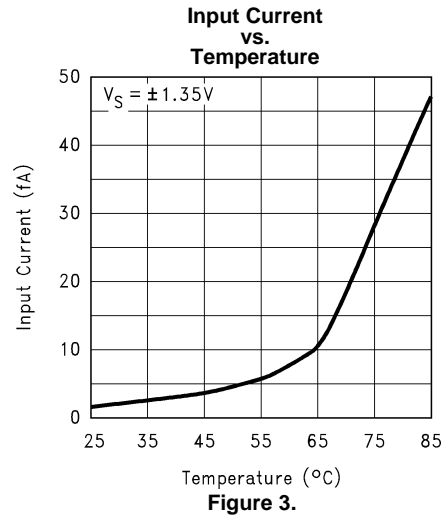
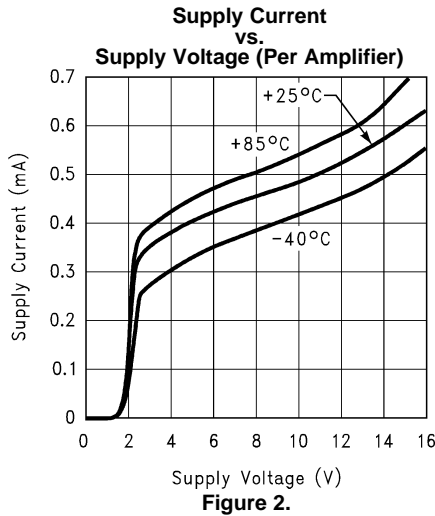

**Typical Performance Characteristics (continued)**

Unless otherwise specified,  $V_S = 2.7V$ , single supply,  $T_A = 25^\circ C$

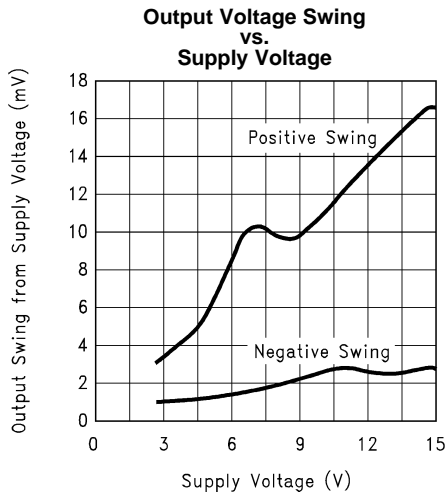

**Figure 8.**

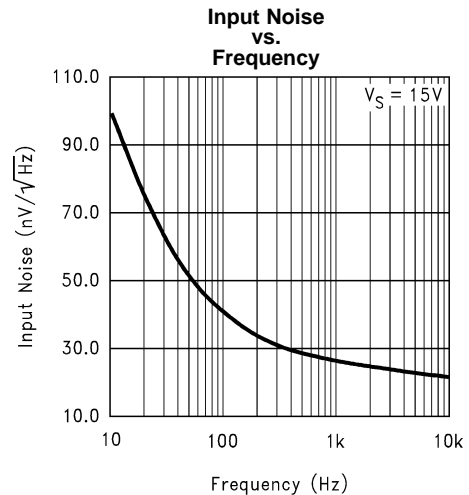

**Figure 9.**

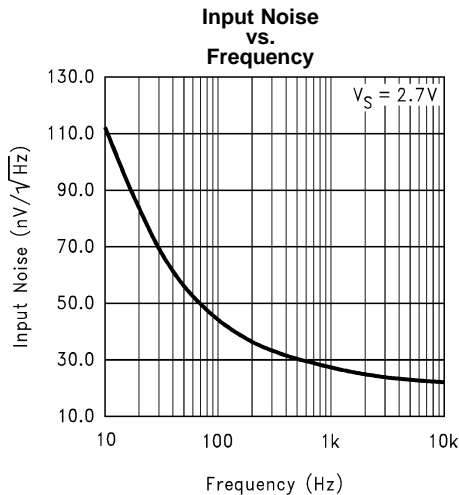

**Figure 10.**

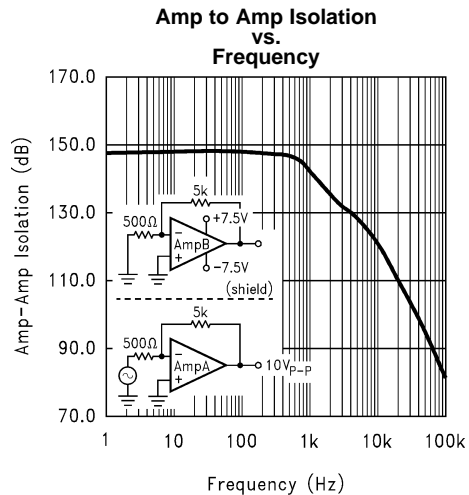

**Figure 11.**

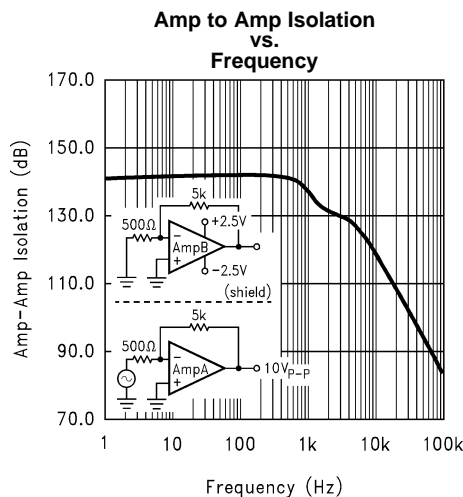

**Figure 12.**

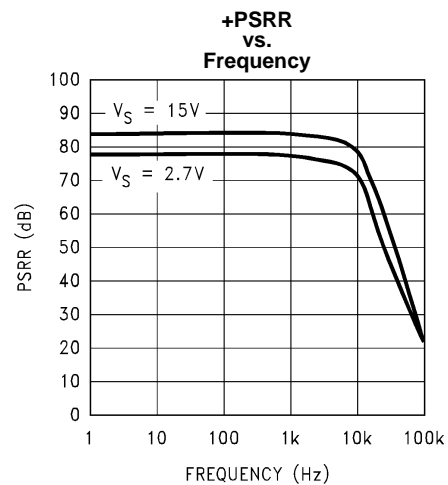

**Figure 13.**

Typical Performance Characteristics (continued)

Unless otherwise specified,  $V_S = 2.7V$ , single supply,  $T_A = 25^\circ C$

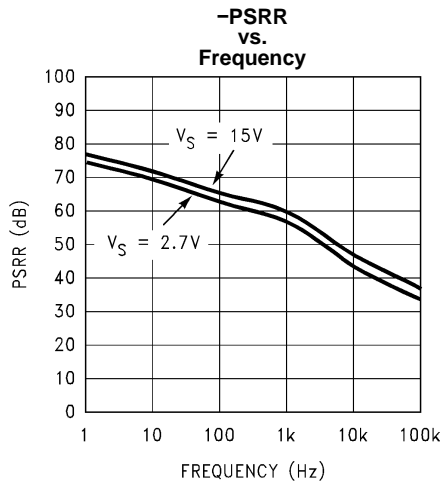

Figure 14.

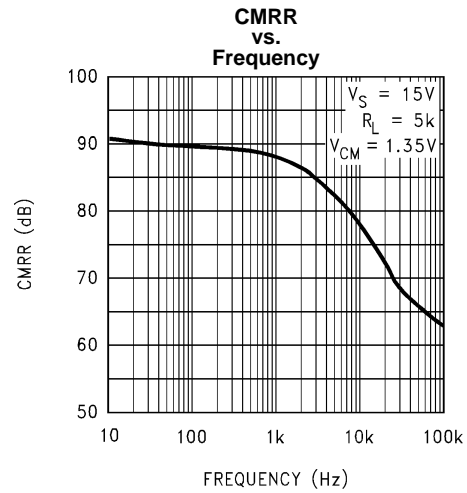

Figure 15.

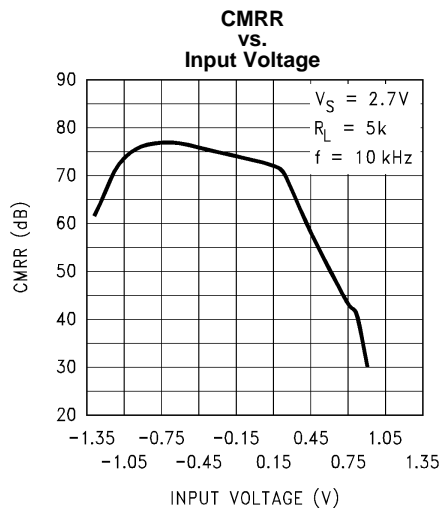

Figure 16.

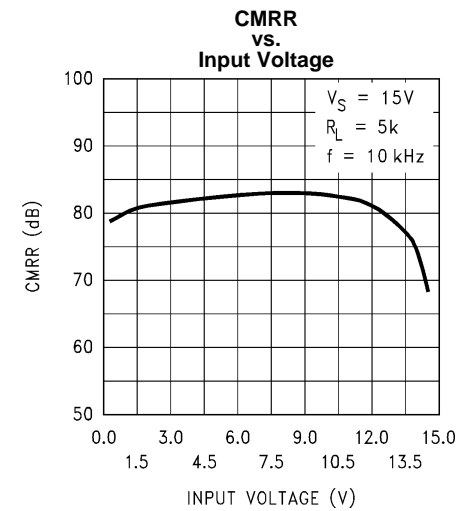

Figure 17.

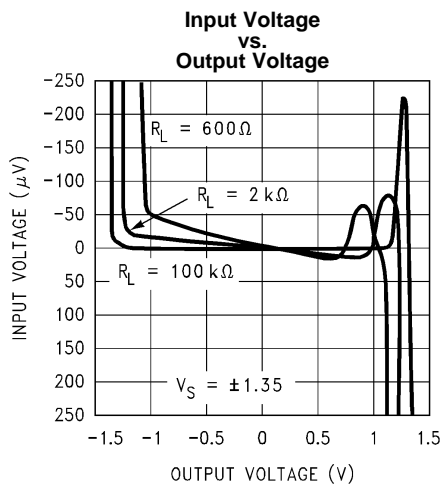

Figure 18.

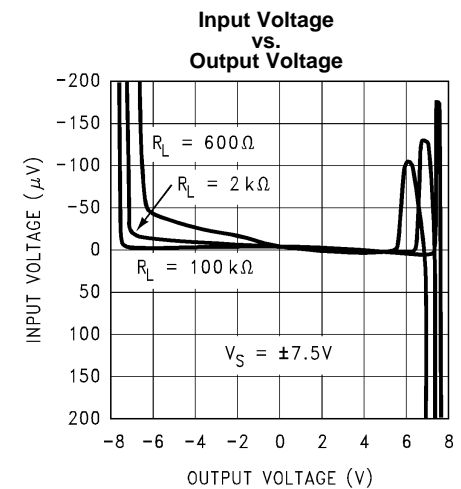

Figure 19.

**Typical Performance Characteristics (continued)**

Unless otherwise specified,  $V_S = 2.7V$ , single supply,  $T_A = 25^\circ C$

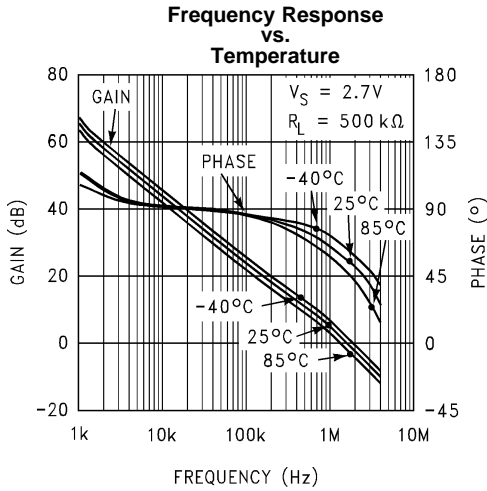

Figure 20.

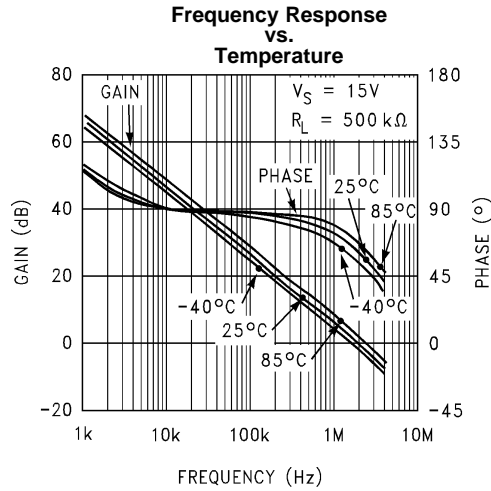

Figure 21.

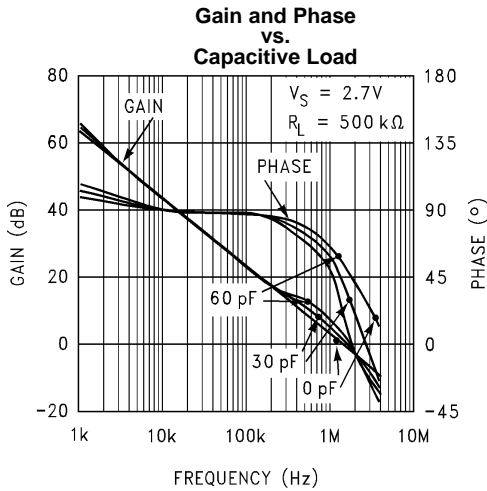

Figure 22.

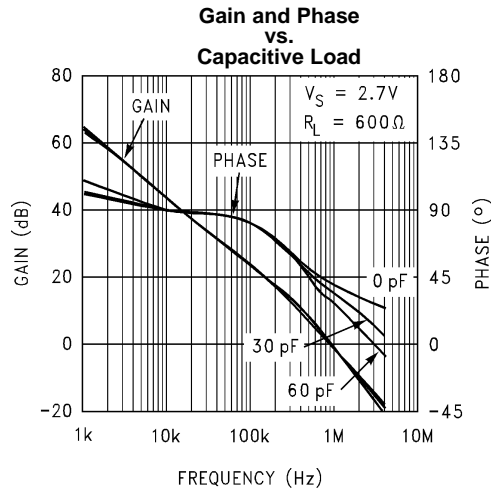

Figure 23.

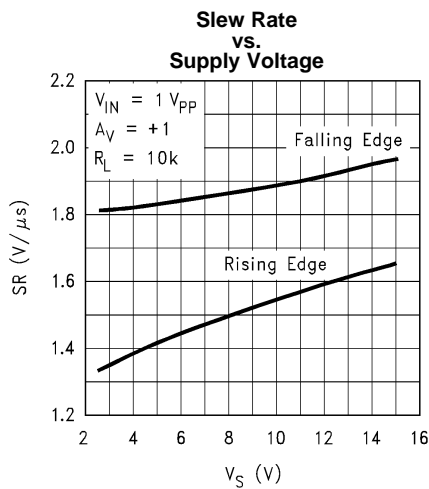

Figure 24.

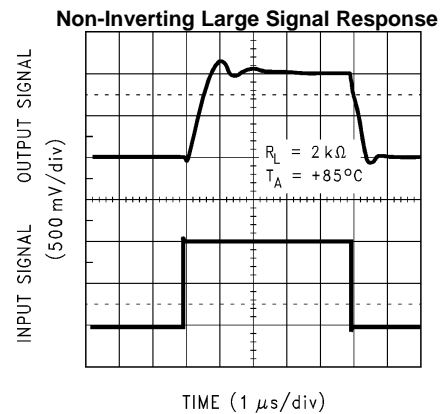
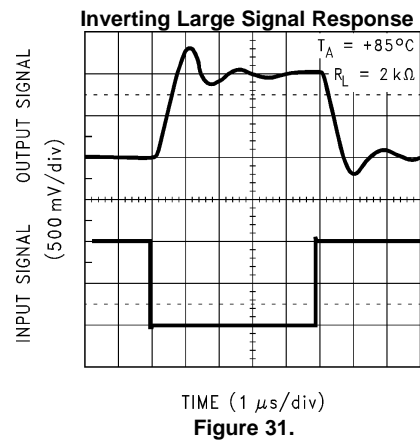
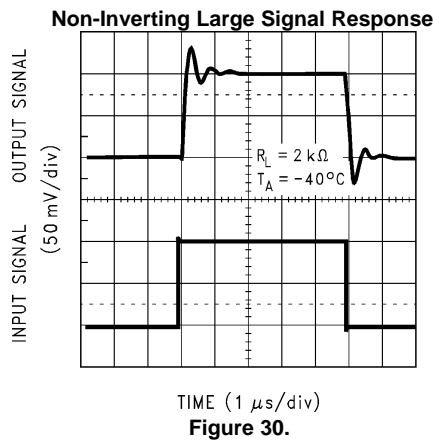
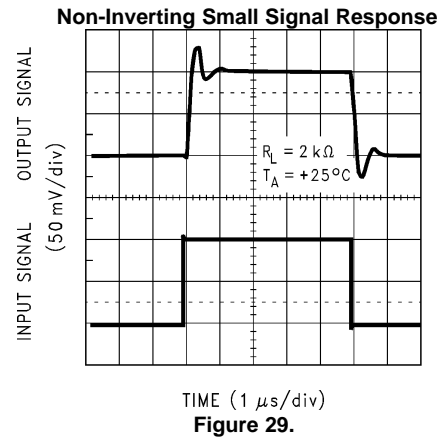
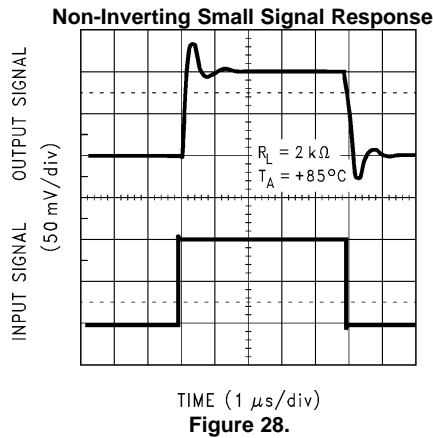
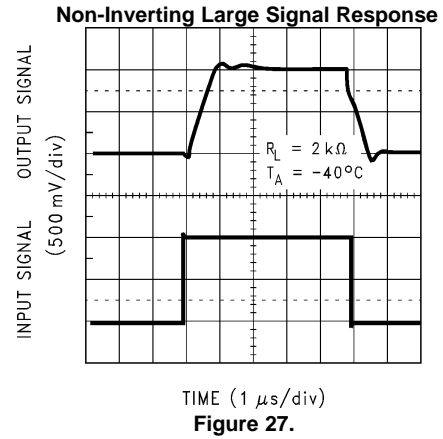
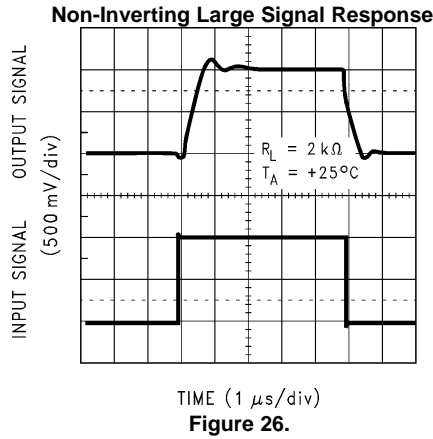

Figure 25.

Typical Performance Characteristics (continued)

Unless otherwise specified,  $V_S = 2.7V$ , single supply,  $T_A = 25^\circ C$



**Typical Performance Characteristics (continued)**

Unless otherwise specified,  $V_S = 2.7V$ , single supply,  $T_A = 25^\circ C$

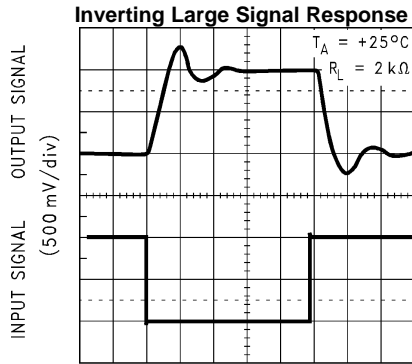

TIME (1  $\mu s$ /div)  
**Figure 32.**

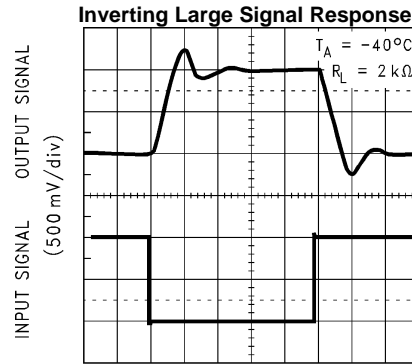

TIME (1  $\mu s$ /div)  
**Figure 33.**

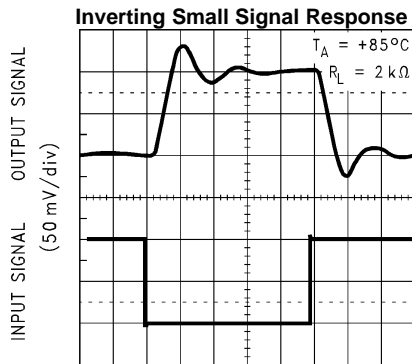

TIME (1  $\mu s$ /div)  
**Figure 34.**

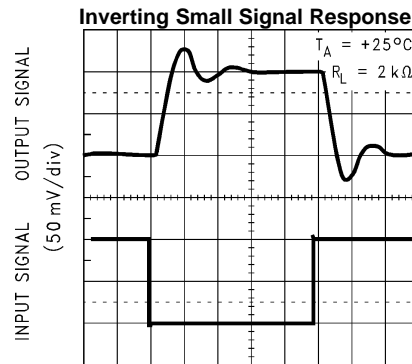

TIME (1  $\mu s$ /div)  
**Figure 35.**

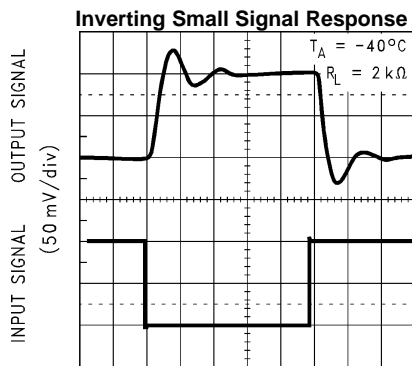

TIME (1  $\mu s$ /div)  
**Figure 36.**

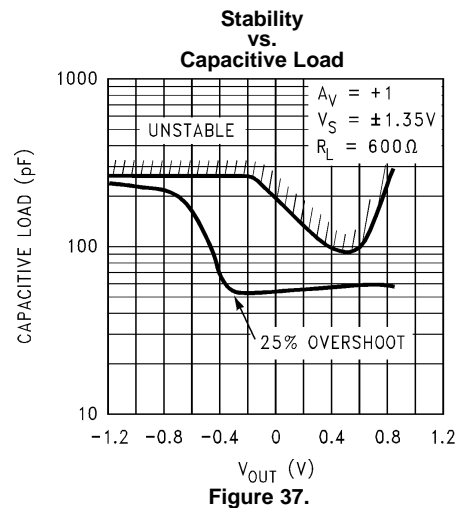

**Figure 37.**

Typical Performance Characteristics (continued)

Unless otherwise specified,  $V_S = 2.7V$ , single supply,  $T_A = 25^\circ C$

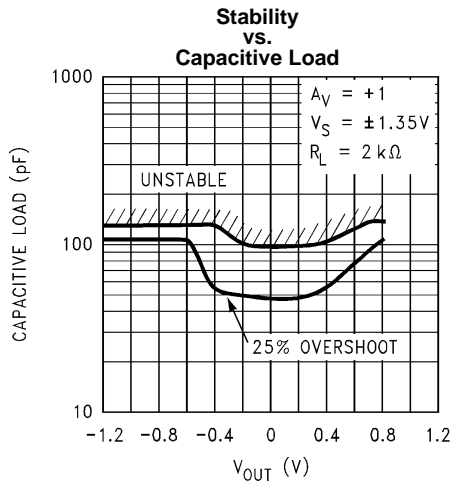

Figure 38.

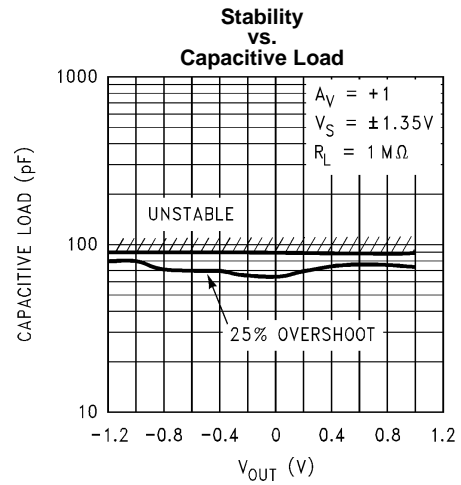

Figure 39.

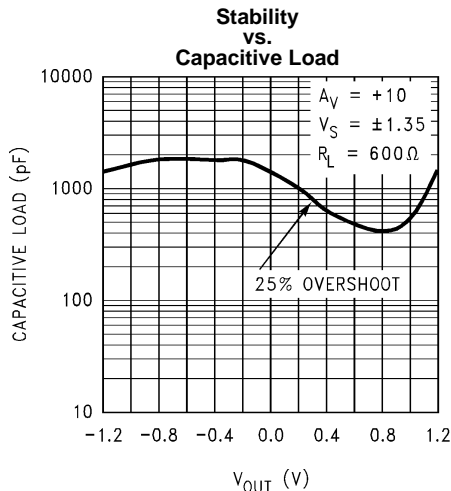

Figure 40.

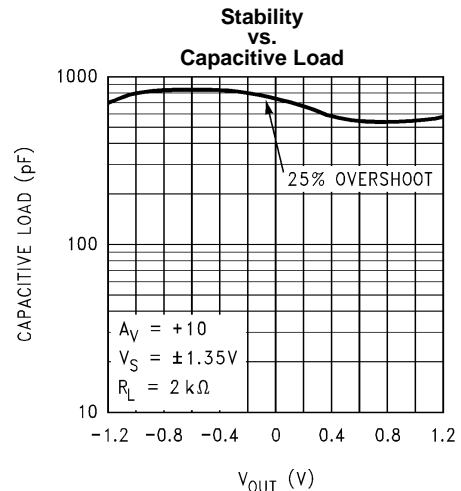

Figure 41.

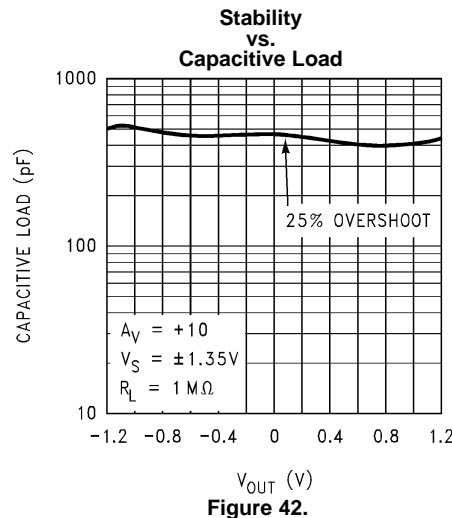
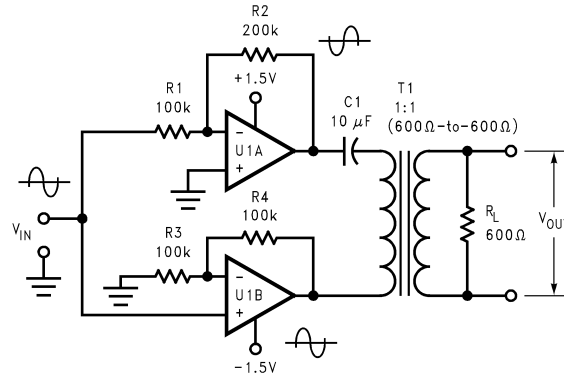

Figure 42.

## APPLICATION NOTES

### Background

The LMC6035/6 is exceptionally well suited for low voltage applications. A desirable feature that the LMC6035/6 brings to low voltage applications is its output drive capability—a hallmark for TI's CMOS amplifiers. The circuit of [Figure 43](#) illustrates the drive capability of the LMC6035/6 at 3V of supply. It is a differential output driver for a one-to-one audio transformer, like those used for isolating ground from the telephone lines. The transformer (T1) loads the op amps with about 600Ω of AC load, at 1 kHz. Capacitor C1 functions to block DC from the low winding resistance of T1. Although the value of C1 is relatively high, its load reactance ( $X_c$ ) is negligible compared to inductive reactance ( $X_l$ ) of T1.



**Figure 43. Differential Driver**

The circuit in [Figure 43](#) consists of one input signal and two output signals. U1A amplifies the input with an inverting gain of  $-2$ , while the U1B amplifies the input with a non-inverting gain of  $+2$ . Since the two outputs are  $180^\circ$  out of phase with each other, the gain across the differential output is 4. As the differential output swings between the supply rails, one of the op amps sources the current to the load, while the other op amp sinks the current.

How good a CMOS op amp can sink or source a current is an important factor in determining its output swing capability. The output stage of the LMC6035/6—like many op amps—sources and sinks output current through two complementary transistors in series. This “totem pole” arrangement translates to a channel resistance ( $R_{dson}$ ) at each supply rail which acts to limit the output swing. Most CMOS op amps are able to swing the outputs very close to the rails—except, however, under the difficult conditions of low supply voltage and heavy load. The LMC6035/6 exhibits exceptional output swing capability under these conditions.

The scope photos of [Figure 44](#) and [Figure 45](#) represent measurements taken directly at the output (relative to GND) of U1A, in [Figure 43](#). [Figure 44](#) illustrates the output swing capability of the LMC6035, while [Figure 45](#) provides a benchmark comparison. (The benchmark op amp is another low voltage (3V) op amp manufactured by one of our reputable competitors.)

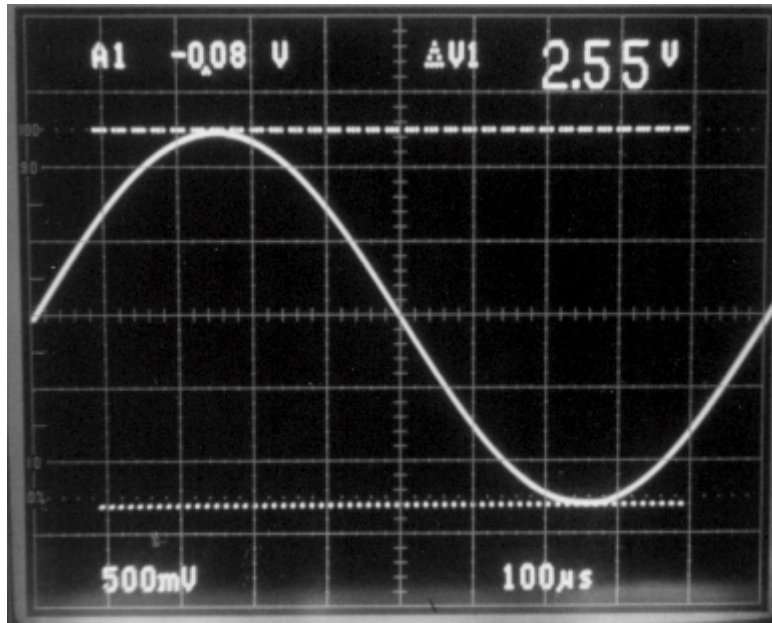

Figure 44. Output Swing Performance of the LMC6035 per the Circuit of Figure 43

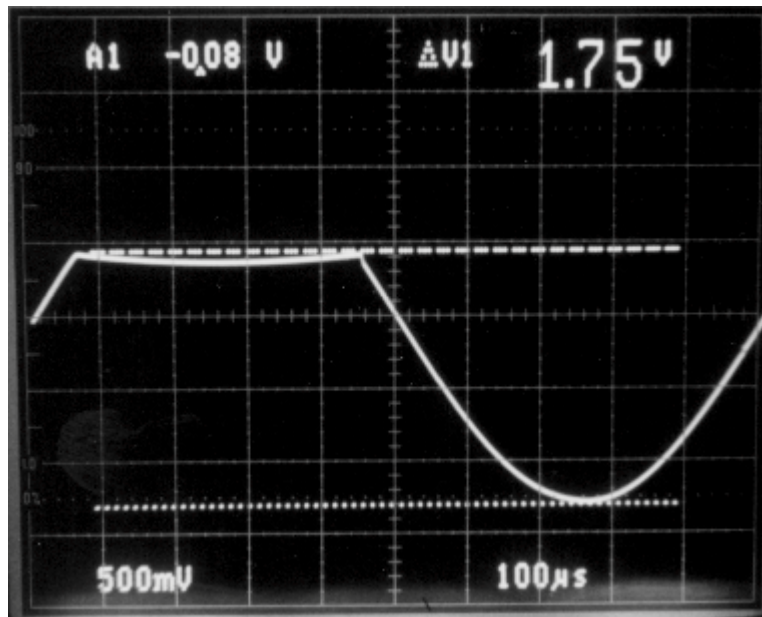

Figure 45. Output Swing Performance of Benchmark Op Amp per the Circuit of Figure 43

Notice the superior drive capability of LMC6035 when compared with the benchmark measurement—even though the benchmark op amp uses twice the supply current.

Not only does the LMC6035/6 provide excellent output swing capability at low supply voltages, it also maintains high open loop gain ( $A_{VOL}$ ) with heavy loads. To illustrate this, the LMC6035 and the benchmark op amp were compared for their distortion performance in the circuit of Figure 43. The graph of Figure 46 shows this comparison. The y-axis represents percent Total Harmonic Distortion (THD plus noise) across the loaded secondary of T1. The x-axis represents the input amplitude of a 1 kHz sine wave. (Note that T1 loses about 20% of the voltage to the voltage divider of  $R_L$  (600 $\Omega$ ) and T1's winding resistances—a performance deficiency of the transformer.)

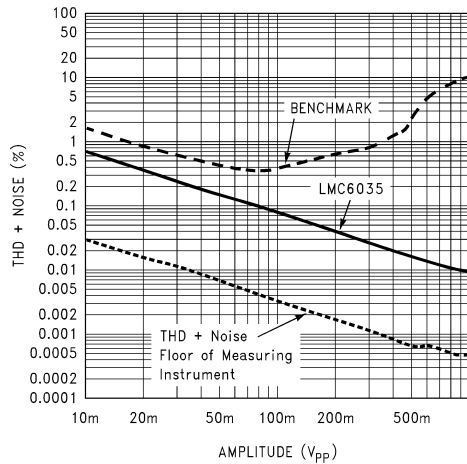

Figure 46. THD+Noise Performance of LMC6035 and “Benchmark” per Circuit of Figure 43

Figure 46 shows the superior distortion performance of LMC6035/6 over that of the benchmark op amp. The heavy loading of the circuit causes the  $A_{VOL}$  of the benchmark part to drop significantly which causes increased distortion.

## APPLICATION CIRCUITS

### Low-Pass Active Filter

A common application for low voltage systems would be active filters, in cordless and cellular phones for example. The ultra low input currents ( $I_{IN}$ ) of the LMC6035/6 makes it well suited for low power active filter applications, because it allows the use of higher resistor values and lower capacitor values. This reduces power consumption and space.

Figure 47 shows a low pass, active filter with a Butterworth (maximally flat) frequency response. Its topology is a Sallen and Key filter with unity gain. Note the normalized component values in parenthesis which are obtainable from standard filter design handbooks. These values provide a 1Hz cutoff frequency, but they can be easily scaled for a desired cutoff frequency ( $f_c$ ). The bold component values of Figure 47 provide a cutoff frequency of 3kHz. An example of the scaling procedure follows Figure 47.

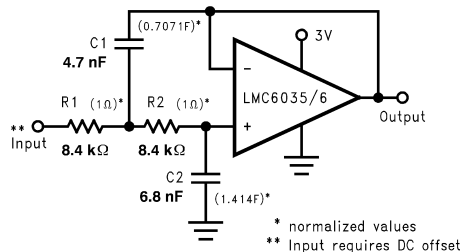

Figure 47. 2-Pole, 3kHz, Active, Sallen and Key, Lowpass Filter with Butterworth Response

### Low-Pass Frequency Scaling Procedure

The actual component values represented in bold of [Figure 47](#) were obtained with the following scaling procedure:

1. First determine the frequency scaling factor (FSF) for the desired cutoff frequency. Choosing  $f_c$  at 3kHz, provides the following FSF computation:  

$$- \text{FSF} = 2\pi \times 3\text{kHz} \text{ (desired cutoff freq.)} = 18.84 \times 10^3$$
2. Then divide all of the normalized capacitor values by the FSF as follows:  $C1' = C_{(\text{Normalized})}/\text{FSF}$   $C1' = 0.707/18.84 \times 10^3 = 37.93 \times 10^{-6}$   $C2' = 1.414/18.84 \times 10^3 = 75.05 \times 10^{-6}$  ( $C1'$  and  $C2'$ : prior to impedance scaling)
3. Last, choose an impedance scaling factor (Z). This Z factor can be calculated from a standard value for  $C2$ . Then Z can be used to determine the remaining component values as follows:

$$Z = C2'/C2_{(\text{chosen})} = 75.05 \times 10^{-6}/\mathbf{6.8\text{nF}} = 8.4\text{k}$$

$$C1 = C1'/Z = 37.93 \times 10^{-6}/8.4\text{k} = 4.52\text{nF}$$

$$\text{(Standard capacitor value chosen for } C1 \text{ is } \mathbf{4.7\text{nF}} \text{ )} \quad R1 = R1_{(\text{normalized})} \times Z = 1\Omega \times 8.4\text{k} = 8.4\text{k}\Omega \quad R2 = R2_{(\text{normalized})} \times Z = 1\Omega \times 8.4\text{k} = 8.4\text{k}\Omega$$

(Standard value chosen for  $R1$  and  $R2$  is  $\mathbf{8.45\text{k}\Omega}$  )

### High Pass Active Filter

The previous low-pass filter circuit of [Figure 47](#) converts to a high-pass active filter per [Figure 48](#).

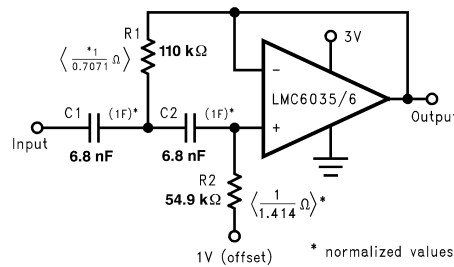

**Figure 48. 2 Pole, 300Hz, Sallen and Key, High-Pass Filter**

### High-Pass Frequency Scaling Procedure

Choose a standard capacitor value and scale the impedances in the circuit according to the desired cutoff frequency (300Hz) as follows:  $C = C1 = C2$   $Z = 1 \text{ Farad}/C_{(\text{chosen})} \times 2\pi \times (\text{desired cutoff freq.}) = 1 \text{ Farad}/\mathbf{6.8\text{nF}} \times 2\pi \times 300 \text{ Hz} = 78.05\text{k}$

$$R1 = Z \times R1_{(\text{normalized})} = 78.05\text{k} \times (1/0.707) = 110.4\text{k}\Omega$$

(Standard value chosen for  $R1$  is  $\mathbf{110\text{k}\Omega}$  )

$$R2 = Z \times R2_{(\text{normalized})} = 78.05\text{k} \times (1/1.414) = 55.2\text{k}\Omega$$

(Standard value chosen for  $R1$  is  $\mathbf{54.9\text{k}\Omega}$  )

### Dual Amplifier Bandpass Filter

The dual amplifier bandpass (DABP) filter features the ability to independently adjust  $f_c$  and Q. In most other bandpass topologies, the  $f_c$  and Q adjustments interact with each other. The DABP filter also offers both low sensitivity to component values and high Qs. The following application of [Figure 49](#), provides a 1kHz center frequency and a Q of 100.

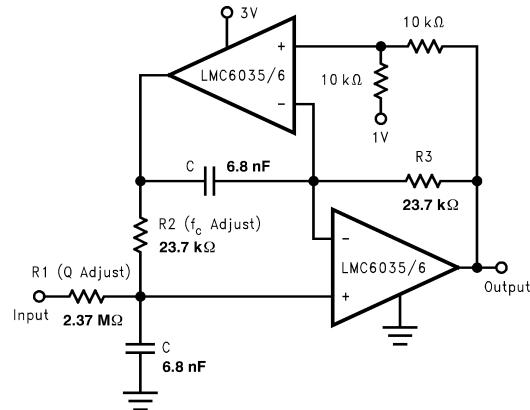

**Figure 49. 2 Pole, 1kHz Active, Bandpass Filter**

### DABP Component Selection Procedure

Component selection for the DABP filter is performed as follows:

1. First choose a center frequency ( $f_c$ ). Figure 49 represents component values that were obtained from the following computation for a center frequency of 1kHz.  $R_2 = R_3 = 1/(2\pi f_c C)$  Given:  $f_c = 1\text{kHz}$  and  $C$  (chosen) = **6.8nF**  $R_2 = R_3 = 1/(2\pi \times 1\text{kHz} \times 6.8\text{nF}) = 23.4\text{k}\Omega$   
 – (Chosen standard value is **23.7kΩ**)
2. Then compute  $R_1$  for a desired  $Q$  ( $f_c/\text{BW}$ ) as follows:  $R_1 = Q \times R_2$ . Choosing a  $Q$  of 100,  $R_1 = 100 \times 23.7\text{k}\Omega = \mathbf{2.37M\Omega}$ .

### PRINTED-CIRCUIT-BOARD LAYOUT FOR HIGH-IMPEDANCE WORK

It is generally recognized that any circuit which must operate with  $< 1000\text{pA}$  of leakage current requires special layout of the PC board. If one wishes to take advantage of the ultra-low bias current of the LMC6035/6, typically  $< 0.04\text{pA}$ , it is essential to have an excellent layout. Fortunately, the techniques for obtaining low leakages are quite simple. First, the user must not ignore the surface leakage of the PC board, even though it may at times appear acceptably low. Under conditions of high humidity, dust or contamination, the surface leakage will be appreciable.

To minimize the effect of any surface leakage, lay out a ring of foil completely surrounding the LMC6035 or LMC6036 inputs and the terminals of capacitors, diodes, conductors, resistors, relay terminals, etc. connected to the op amp's inputs. See Figure 50. To have a significant effect, guard rings should be placed on both the top and bottom of the PC board. This PC foil must then be connected to a voltage which is at the same voltage as the amplifier inputs, since no leakage current can flow between two points at the same potential. For example, a PC board trace-to-pad resistance of  $10^{12}\Omega$ , which is normally considered a very large resistance, could leak  $5\text{pA}$  if the trace were a  $5\text{V}$  bus adjacent to the pad of an input. This would cause a 100 times degradation from the amplifier's actual performance. However, if a guard ring is held within  $5\text{mV}$  of the inputs, then even a resistance of  $10^{11}\Omega$  would cause only  $0.05\text{pA}$  of leakage current, or perhaps a minor (2:1) degradation of the amplifier's performance. See Figure 51(a) through Figure 51(c) for typical connections of guard rings for standard op amp configurations. If both inputs are active and at high impedance, the guard can be tied to ground and still provide some protection; see Figure 51(d).

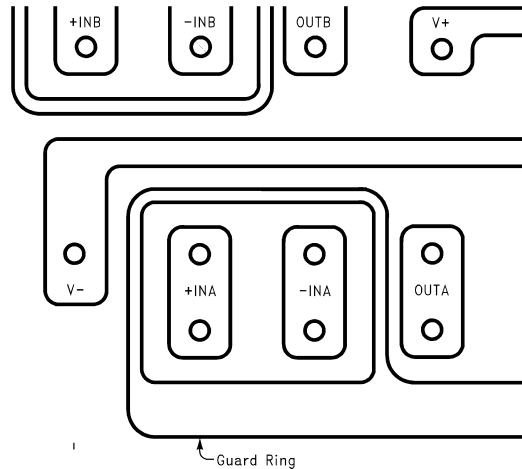

Figure 50. Example, using the LMC6036 of Guard Ring in PC Board Layout

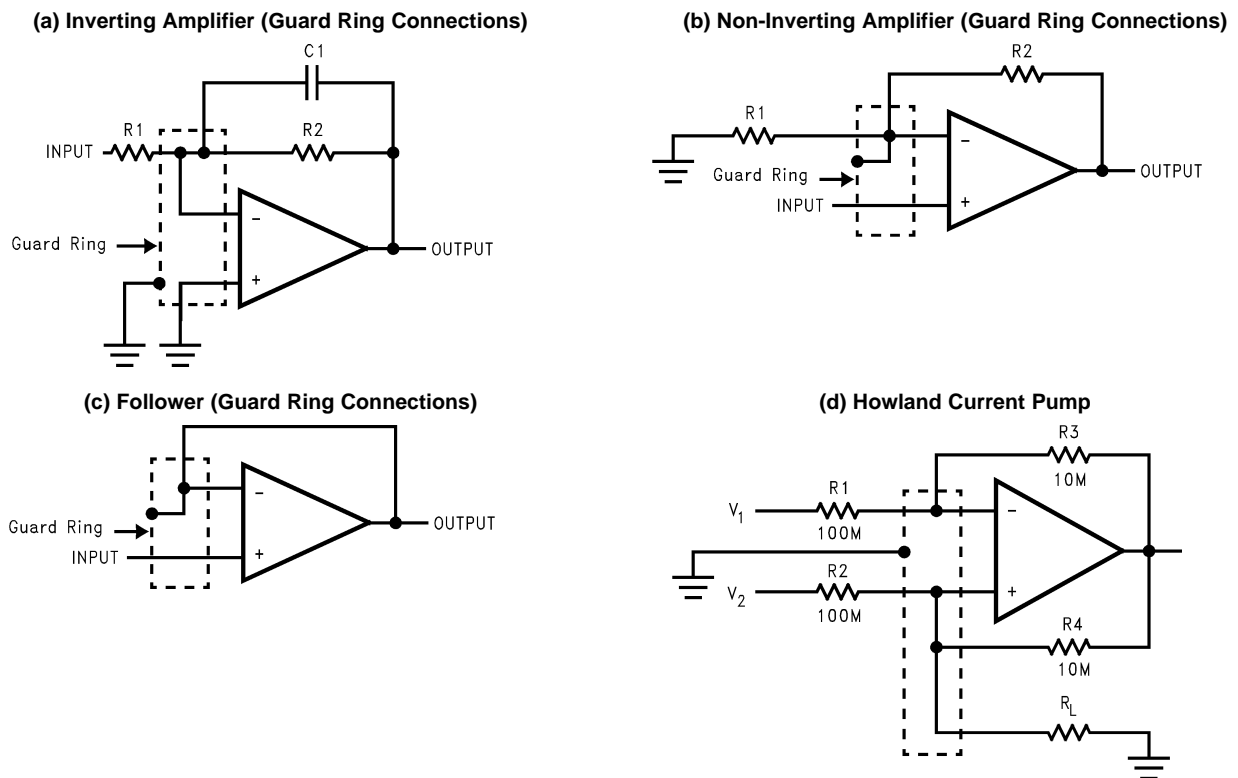

Figure 51. Guard Ring Connections

### CAPACITIVE LOAD TOLERANCE

Like many other op amps, the LMC6035/6 may oscillate when its applied load appears capacitive. The threshold of oscillation varies both with load and circuit gain. The configuration most sensitive to oscillation is a unity-gain follower. See the Typical Performance Characteristics.

The load capacitance interacts with the op amp's output resistance to create an additional pole. If this pole frequency is sufficiently low, it will degrade the op amp's phase margin so that the amplifier is no longer stable at low gains. As shown in [Figure 52](#), the addition of a small resistor (50Ω–100Ω) in series with the op amp's output, and a capacitor (5pF–10pF) from inverting input to output pins, returns the phase margin to a safe value without interfering with lower-frequency circuit operation. Thus, larger values of capacitance can be tolerated without oscillation. Note that in all cases, the output will ring heavily when the load capacitance is near the threshold for oscillation.

### DSBGA Considerations

Contrary to what might be guessed, the DSBGA package does not follow the trend of smaller packages having higher thermal resistance. LMC6035 in DSBGA has thermal resistance of 220°C/W compared to 230°C/W in VSSOP. Even when driving a 600Ω load and operating from ±7.5V supplies, the maximum temperature rise will be under 4.5°C. For application information specific to DSBGA, see Application note AN-1112 (Literature Number [SNVA009](#)).

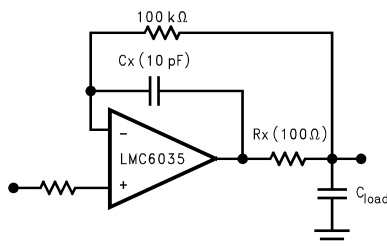

Figure 52. Rx, Cx Improve Capacitive Load Tolerance

Capacitive load driving capability is enhanced by using a pull up resistor to V+ ([Figure 53](#)). Typically a pull up resistor conducting 500μA or more will significantly improve capacitive load responses. The value of the pull up resistor must be determined based on the current sinking capability of the amplifier with respect to the desired output swing. Open loop gain of the amplifier can also be affected by the pull up resistor (see [Electrical Characteristics](#)).

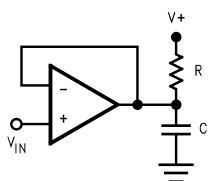

Figure 53. Compensating for Large Capacitive Loads with a Pull Up Resistor

### Connection Diagrams

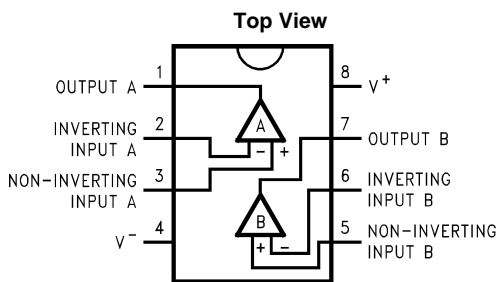

Figure 54. 8-Pin SOIC or VSSOP Package  
See Package Number D0008A or DGK0008A

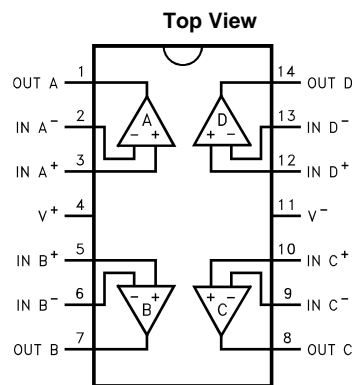

Figure 55. 14-Pin SOIC or TSSOP Package  
See Package Number D0014A or PW0014A

**PACKAGING INFORMATION**

Orderable Device	Status (1)	Package Type	Package Drawing	Pins	Package Qty	Eco Plan (2)	Lead/Ball Finish (6)	MSL Peak Temp (3)	Op Temp (°C)	Device Marking (4/5)	Samples
LMC6035IM/NOPB	ACTIVE	SOIC	D	8	95	Green (RoHS & no Sb/Br)	CU SN	Level-1-260C-UNLIM	-40 to 85	LMC6035IM	<a href="#">Samples</a>
LMC6035IMM/NOPB	ACTIVE	VSSOP	DGK	8	1000	Green (RoHS & no Sb/Br)	CU SN	Level-1-260C-UNLIM	-40 to 85	A06B	<a href="#">Samples</a>
LMC6035IMMX/NOPB	ACTIVE	VSSOP	DGK	8	3500	Green (RoHS & no Sb/Br)	CU SN	Level-1-260C-UNLIM	-40 to 85	A06B	<a href="#">Samples</a>
LMC6035IMQ1	ACTIVE	SOIC	D	8	95	Green (RoHS & no Sb/Br)	CU SN	Level-1-260C-UNLIM	-40 to 85	LMC6035IMQ	<a href="#">Samples</a>
LMC6035IMX/NOPB	ACTIVE	SOIC	D	8	2500	Green (RoHS & no Sb/Br)	CU SN	Level-1-260C-UNLIM	-40 to 85	LMC6035IM	<a href="#">Samples</a>
LMC6035IMXQ1	ACTIVE	SOIC	D	8	2500	Green (RoHS & no Sb/Br)	CU SN	Level-1-260C-UNLIM	-40 to 85	LMC6035IMQ	<a href="#">Samples</a>
LMC6035ITL/NOPB	ACTIVE	DSBGA	YZR	8	250	Green (RoHS & no Sb/Br)	SNAGCU	Level-1-260C-UNLIM	-40 to 85	A80	<a href="#">Samples</a>
LMC6035ITLX/NOPB	ACTIVE	DSBGA	YZR	8	3000	Green (RoHS & no Sb/Br)	SNAGCU	Level-1-260C-UNLIM	-40 to 85	A80	<a href="#">Samples</a>
LMC6036IM/NOPB	ACTIVE	SOIC	D	14	55	Green (RoHS & no Sb/Br)	CU SN	Level-1-260C-UNLIM	-40 to 85	LMC6036IM	<a href="#">Samples</a>
LMC6036IMT/NOPB	ACTIVE	TSSOP	PW	14	94	Green (RoHS & no Sb/Br)	CU SN	Level-1-260C-UNLIM	-40 to 85	LMC6036IMT	<a href="#">Samples</a>
LMC6036IMTX/NOPB	ACTIVE	TSSOP	PW	14	2500	Green (RoHS & no Sb/Br)	CU SN	Level-1-260C-UNLIM	-40 to 85	LMC6036IMT	<a href="#">Samples</a>
LMC6036IMX/NOPB	ACTIVE	SOIC	D	14	2500	Green (RoHS & no Sb/Br)	CU SN	Level-1-260C-UNLIM	-40 to 85	LMC6036IM	<a href="#">Samples</a>

(1) The marketing status values are defined as follows:

**ACTIVE:** Product device recommended for new designs.

**LIFEBUY:** TI has announced that the device will be discontinued, and a lifetime-buy period is in effect.

**NRND:** Not recommended for new designs. Device is in production to support existing customers, but TI does not recommend using this part in a new design.

**PREVIEW:** Device has been announced but is not in production. Samples may or may not be available.

**OBSELETE:** TI has discontinued the production of the device.

(2) **RoHS:** TI defines "RoHS" to mean semiconductor products that are compliant with the current EU RoHS requirements for all 10 RoHS substances, including the requirement that RoHS substance do not exceed 0.1% by weight in homogeneous materials. Where designed to be soldered at high temperatures, "RoHS" products are suitable for use in specified lead-free processes. TI may reference these types of products as "Pb-Free".

**RoHS Exempt:** TI defines "RoHS Exempt" to mean products that contain lead but are compliant with EU RoHS pursuant to a specific EU RoHS exemption.

---

**Green:** TI defines "Green" to mean the content of Chlorine (Cl) and Bromine (Br) based flame retardants meet JS709B low halogen requirements of  $\leq 1000$ ppm threshold. Antimony trioxide based flame retardants must also meet the  $\leq 1000$ ppm threshold requirement.

- (3) MSL, Peak Temp. - The Moisture Sensitivity Level rating according to the JEDEC industry standard classifications, and peak solder temperature.
- (4) There may be additional marking, which relates to the logo, the lot trace code information, or the environmental category on the device.
- (5) Multiple Device Markings will be inside parentheses. Only one Device Marking contained in parentheses and separated by a "~" will appear on a device. If a line is indented then it is a continuation of the previous line and the two combined represent the entire Device Marking for that device.
- (6) Lead/Ball Finish - Orderable Devices may have multiple material finish options. Finish options are separated by a vertical ruled line. Lead/Ball Finish values may wrap to two lines if the finish value exceeds the maximum column width.

**Important Information and Disclaimer:** The information provided on this page represents TI's knowledge and belief as of the date that it is provided. TI bases its knowledge and belief on information provided by third parties, and makes no representation or warranty as to the accuracy of such information. Efforts are underway to better integrate information from third parties. TI has taken and continues to take reasonable steps to provide representative and accurate information but may not have conducted destructive testing or chemical analysis on incoming materials and chemicals. TI and TI suppliers consider certain information to be proprietary, and thus CAS numbers and other limited information may not be available for release.

In no event shall TI's liability arising out of such information exceed the total purchase price of the TI part(s) at issue in this document sold by TI to Customer on an annual basis.

**OTHER QUALIFIED VERSIONS OF LMC6035, LMC6035-Q1 :**

- Catalog: [LMC6035](#)
- Automotive: [LMC6035-Q1](#)

NOTE: Qualified Version Definitions:

- Catalog - TI's standard catalog product
- Automotive - Q100 devices qualified for high-reliability automotive applications targeting zero defects

**TAPE AND REEL INFORMATION**

**QUADRANT ASSIGNMENTS FOR PIN 1 ORIENTATION IN TAPE**

\*All dimensions are nominal

Device	Package Type	Package Drawing	Pins	SPQ	Reel Diameter (mm)	Reel Width W1 (mm)	A0 (mm)	B0 (mm)	K0 (mm)	P1 (mm)	W (mm)	Pin1 Quadrant
LMC6035IMM/NOPB	VSSOP	DGK	8	1000	178.0	12.4	5.3	3.4	1.4	8.0	12.0	Q1
LMC6035IMMX/NOPB	VSSOP	DGK	8	3500	330.0	12.4	5.3	3.4	1.4	8.0	12.0	Q1
LMC6035IMX/NOPB	SOIC	D	8	2500	330.0	12.4	6.5	5.4	2.0	8.0	12.0	Q1
LMC6035IMXQ1	SOIC	D	8	2500	330.0	12.4	6.5	5.4	2.0	8.0	12.0	Q1
LMC6035ITL/NOPB	DSBGA	YZR	8	250	178.0	8.4	1.85	2.01	0.76	4.0	8.0	Q1
LMC6035ITLX/NOPB	DSBGA	YZR	8	3000	178.0	8.4	1.85	2.01	0.76	4.0	8.0	Q1
LMC6036IMTX/NOPB	TSSOP	PW	14	2500	330.0	12.4	6.95	5.6	1.6	8.0	12.0	Q1
LMC6036IMX/NOPB	SOIC	D	14	2500	330.0	16.4	6.5	9.35	2.3	8.0	16.0	Q1

**TAPE AND REEL BOX DIMENSIONS**

\*All dimensions are nominal

Device	Package Type	Package Drawing	Pins	SPQ	Length (mm)	Width (mm)	Height (mm)
LMC6035IMM/NOPB	VSSOP	DGK	8	1000	210.0	185.0	35.0
LMC6035IMMX/NOPB	VSSOP	DGK	8	3500	367.0	367.0	35.0
LMC6035IMX/NOPB	SOIC	D	8	2500	367.0	367.0	35.0
LMC6035IMXQ1	SOIC	D	8	2500	367.0	367.0	35.0
LMC6035ITL/NOPB	DSBGA	YZR	8	250	210.0	185.0	35.0
LMC6035ITLX/NOPB	DSBGA	YZR	8	3000	210.0	185.0	35.0
LMC6036IMTX/NOPB	TSSOP	PW	14	2500	367.0	367.0	35.0
LMC6036IMX/NOPB	SOIC	D	14	2500	367.0	367.0	35.0

YZR0008

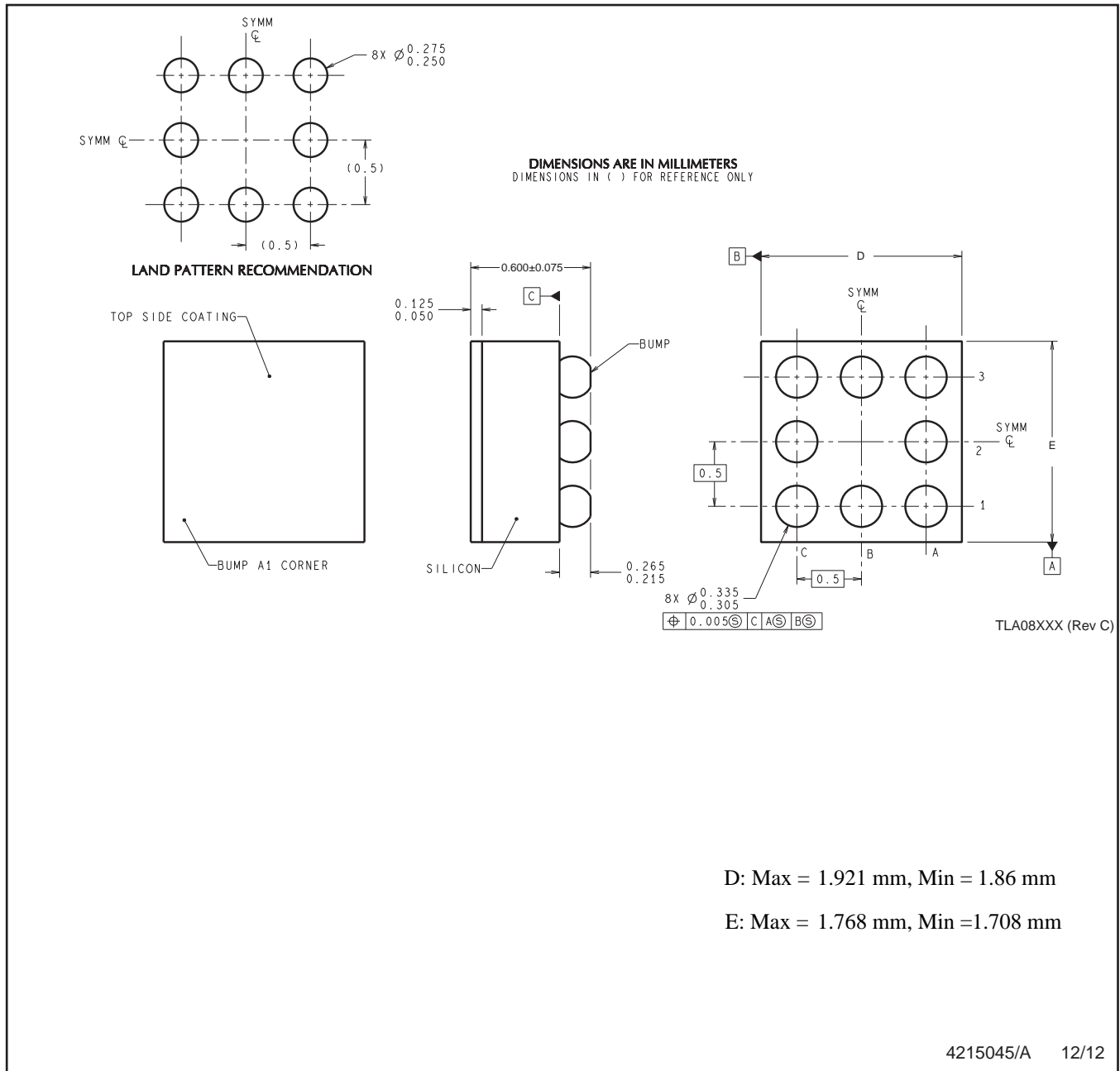



NOTES: A. All linear dimensions are in millimeters. Dimensioning and tolerancing per ASME Y14.5M-1994.  
B. This drawing is subject to change without notice.

D (R-PDSO-G14)

PLASTIC SMALL OUTLINE



- NOTES:
- A. All linear dimensions are in inches (millimeters).
  - B. This drawing is subject to change without notice.
  -  Body length does not include mold flash, protrusions, or gate burrs. Mold flash, protrusions, or gate burrs shall not exceed 0.006 (0,15) each side.
  -  Body width does not include interlead flash. Interlead flash shall not exceed 0.017 (0,43) each side.
  - E. Reference JEDEC MS-012 variation AB.

D (R-PDSO-G14)

PLASTIC SMALL OUTLINE



- NOTES:
- All linear dimensions are in millimeters.
  - This drawing is subject to change without notice.
  - Publication IPC-7351 is recommended for alternate designs.
  - Laser cutting apertures with trapezoidal walls and also rounding corners will offer better paste release. Customers should contact their board assembly site for stencil design recommendations. Refer to IPC-7525 for other stencil recommendations.
  - Customers should contact their board fabrication site for solder mask tolerances between and around signal pads.



PW (R-PDSO-G14)

PLASTIC SMALL OUTLINE



4211284-2/G 08/15

- NOTES:
- All linear dimensions are in millimeters.
  - This drawing is subject to change without notice.
  - Publication IPC-7351 is recommended for alternate designs.
  - Laser cutting apertures with trapezoidal walls and also rounding corners will offer better paste release. Customers should contact their board assembly site for stencil design recommendations. Refer to IPC-7525 for other stencil recommendations.
  - Customers should contact their board fabrication site for solder mask tolerances between and around signal pads.



# EXAMPLE BOARD LAYOUT

D0008A

SOIC - 1.75 mm max height

SMALL OUTLINE INTEGRATED CIRCUIT



LAND PATTERN EXAMPLE  
EXPOSED METAL SHOWN  
SCALE:8X



SOLDER MASK DETAILS

4214825/C 02/2019

NOTES: (continued)

6. Publication IPC-7351 may have alternate designs.

7. Solder mask tolerances between and around signal pads can vary based on board fabrication site.

# EXAMPLE STENCIL DESIGN

D0008A

SOIC - 1.75 mm max height

SMALL OUTLINE INTEGRATED CIRCUIT



SOLDER PASTE EXAMPLE  
BASED ON .005 INCH [0.125 MM] THICK STENCIL  
SCALE:8X

4214825/C 02/2019

NOTES: (continued)

8. Laser cutting apertures with trapezoidal walls and rounded corners may offer better paste release. IPC-7525 may have alternate design recommendations.
9. Board assembly site may have different recommendations for stencil design.

DGK (S-PDSO-G8)

PLASTIC SMALL-OUTLINE PACKAGE

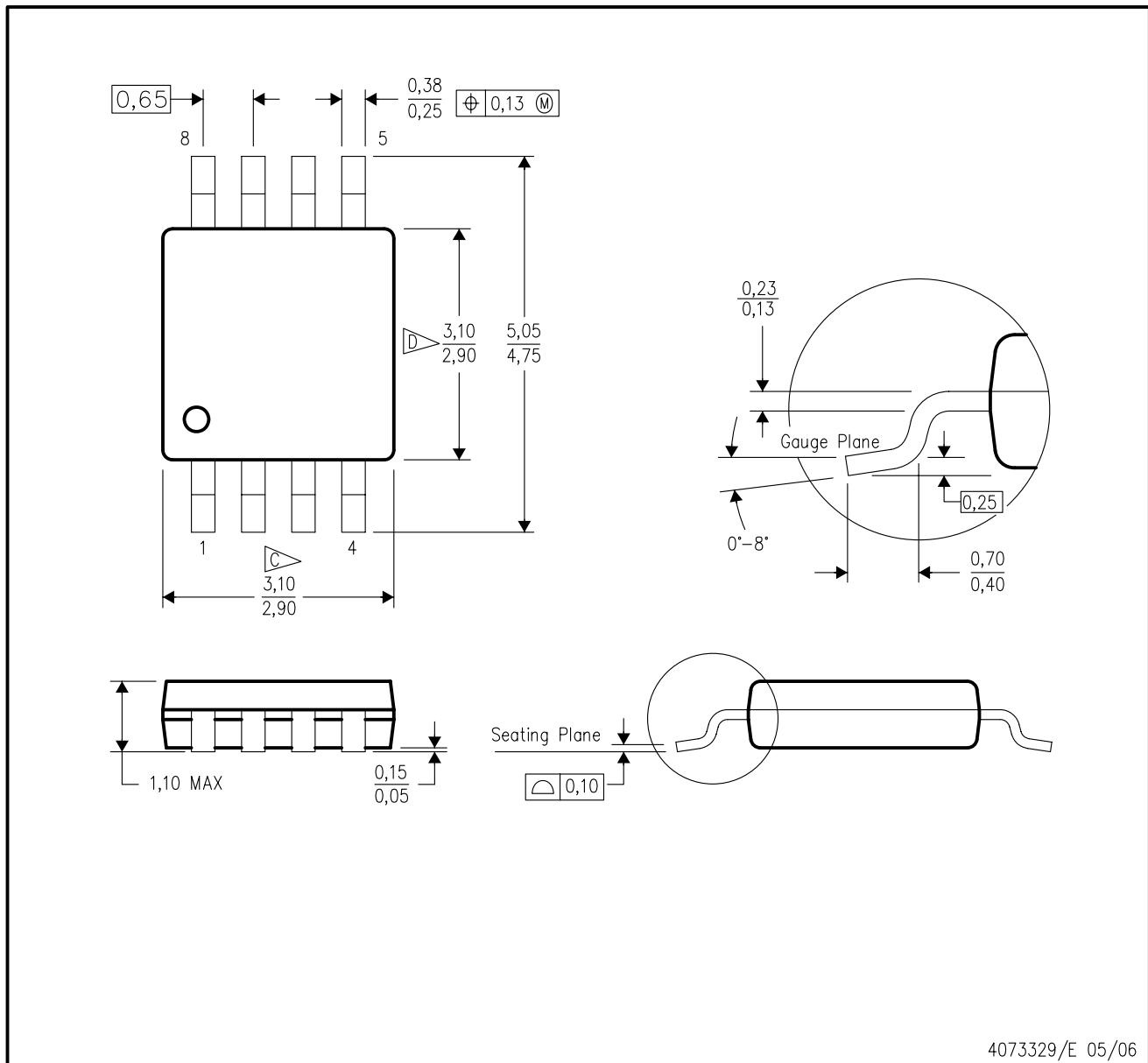

- NOTES:
- A. All linear dimensions are in millimeters.
  - B. This drawing is subject to change without notice.
  - C. Body length does not include mold flash, protrusions, or gate burrs. Mold flash, protrusions, or gate burrs shall not exceed 0.15 per end.
  - D. Body width does not include interlead flash. Interlead flash shall not exceed 0.50 per side.
  - E. Falls within JEDEC MO-187 variation AA, except interlead flash.



- NOTES:
- A. All linear dimensions are in millimeters.
  - B. This drawing is subject to change without notice.
  - C. Publication IPC-7351 is recommended for alternate designs.
  - D. Laser cutting apertures with trapezoidal walls and also rounding corners will offer better paste release. Customers should contact their board assembly site for stencil design recommendations. Refer to IPC-7525 for other stencil recommendations.
  - E. Customers should contact their board fabrication site for solder mask tolerances between and around signal pads.

## IMPORTANT NOTICE AND DISCLAIMER

TI PROVIDES TECHNICAL AND RELIABILITY DATA (INCLUDING DATASHEETS), DESIGN RESOURCES (INCLUDING REFERENCE DESIGNS), APPLICATION OR OTHER DESIGN ADVICE, WEB TOOLS, SAFETY INFORMATION, AND OTHER RESOURCES "AS IS" AND WITH ALL FAULTS, AND DISCLAIMS ALL WARRANTIES, EXPRESS AND IMPLIED, INCLUDING WITHOUT LIMITATION ANY IMPLIED WARRANTIES OF MERCHANTABILITY, FITNESS FOR A PARTICULAR PURPOSE OR NON-INFRINGEMENT OF THIRD PARTY INTELLECTUAL PROPERTY RIGHTS.

These resources are intended for skilled developers designing with TI products. You are solely responsible for (1) selecting the appropriate TI products for your application, (2) designing, validating and testing your application, and (3) ensuring your application meets applicable standards, and any other safety, security, or other requirements. These resources are subject to change without notice. TI grants you permission to use these resources only for development of an application that uses the TI products described in the resource. Other reproduction and display of these resources is prohibited. No license is granted to any other TI intellectual property right or to any third party intellectual property right. TI disclaims responsibility for, and you will fully indemnify TI and its representatives against, any claims, damages, costs, losses, and liabilities arising out of your use of these resources.

TI's products are provided subject to TI's Terms of Sale ([www.ti.com/legal/termsofsale.html](http://www.ti.com/legal/termsofsale.html)) or other applicable terms available either on [ti.com](http://ti.com) or provided in conjunction with such TI products. TI's provision of these resources does not expand or otherwise alter TI's applicable warranties or warranty disclaimers for TI products.

Mailing Address: Texas Instruments, Post Office Box 655303, Dallas, Texas 75265  
Copyright © 2019, Texas Instruments Incorporated

## Looking for pricing, stock, or lifecycle information?

Click below to explore more details on WIN SOURCE:

 [View LMC6035ITL/NOPB on WIN SOURCE](#)

 [Texas Instruments](#) Information

## Optimize Your Supply Chain with WIN SOURCE Solutions

-  Global Sourcing Solution
-  Obsolete Management
-  Cost Control Management
-  Shortage Management
-  Alternative Solution
-  Excess Inventory Management