



# THE DATASHEET OF LMC6442IMX/NOPB



## LMC6442 Dual Micropower Rail-to-Rail Output Single Supply Operational Amplifier

Check for Samples: [LMC6442](#)

### FEATURES

- (Typical,  $V_S = 2.2V$ )
- Output Swing to Within 30 mV of Supply Rail
- High Voltage Gain 103 dB
- Gain Bandwidth Product 9.5 KHz
- Ensured for: 2.2V, 5V, 10V
- Low Supply Current 0.95  $\mu A$ /Amplifier
- Input Voltage Range  $-0.3V$  to  $V^+ - 0.9V$
- 2.1  $\mu W$ /Amplifier Power Consumption
- Stable for  $A_V \geq +2$  or  $A_V \leq -1$

### APPLICATIONS

- Portable Instruments
- Smoke/Gas/CO/Fire Detectors
- Pagers/Cell Phones
- Instrumentation
- Thermostats
- Occupancy Sensors
- Cameras
- Active Badges

### DESCRIPTION

The LMC6442 is ideal for battery powered systems, where very low supply current (less than one microamp per amplifier) and Rail-to-Rail output swing is required. It is characterized for 2.2V to 10V operation, and at 2.2V supply, the LMC6442 is ideal for single (Li-Ion) or two cell (NiCad or alkaline) battery systems.

The LMC6442 is designed for battery powered systems that require long service life through low supply current, such as smoke and gas detectors, and pager or personal communications systems.

Operation from single supply is enhanced by the wide common mode input voltage range which includes the ground (or negative supply) for ground sensing applications. Very low (5 fA, typical) input bias current and near constant supply current over supply voltage enhance the LMC6442's performance near the end-of-life battery voltage.

Designed for closed loop gains of greater than plus two (or minus one), the amplifier has typically 9.5 KHz GBWP (Gain Bandwidth Product). Unity gain can be used with a simple compensation circuit, which also allows capacitive loads of up to 300 pF to be driven, as described in the [Application Information](#) section.

### Connection Diagram

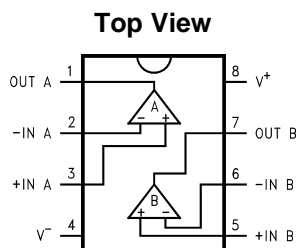

**Figure 1. 8-Pin SOIC / PDIP Package  
See Package Numbers D0008A, P0008E**



These devices have limited built-in ESD protection. The leads should be shorted together or the device placed in conductive foam during storage or handling to prevent electrostatic damage to the MOS gates.



Please be aware that an important notice concerning availability, standard warranty, and use in critical applications of Texas Instruments semiconductor products and disclaimers thereto appears at the end of this data sheet.

All trademarks are the property of their respective owners.

## Absolute Maximum Ratings <sup>(1)(2)</sup>

ESD Tolerance <sup>(3)</sup>	2 kV
Differential Input Voltage	±Supply Voltages
Voltage at Input/Output Pin	(V <sup>+</sup> ) + 0.3V, (V <sup>-</sup> ) – 0.3V
Supply Voltage (V <sup>+</sup> – V <sup>-</sup> ):	16V
Current at Input Pin <sup>(4)</sup>	±5 mA
Current at Output Pin <sup>(5) (6)</sup>	±30 mA
Lead Temp. (soldering 10 sec)	260°C
Storage Temp. Range:	–65°C to +150°C
Junction Temp. <sup>(7)</sup>	150°C

- (1) Absolute Maximum Ratings indicate limits beyond which damage to the device may occur. Operating Ratings indicate conditions for which the device is intended to be functional, but specific performance is not ensured. For ensured specifications and the test conditions, see the Electrical Characteristics.
- (2) If Military/Aerospace specified devices are required, please contact the TI Sales Office/ Distributors for availability and specifications.
- (3) Human body model, 1.5 kΩ in series with 100 pF.
- (4) Limiting input pin current is only necessary for input voltages that exceed absolute maximum input voltage ratings.
- (5) Applies to both single-supply and split-supply operation. Continuous short circuit operation at elevated ambient temperature can result in exceeding the maximum allowed junction temperature of 150°C. Output currents in excess of ±30 mA over long term may adversely affect reliability.
- (6) Do not short circuit output to V<sup>+</sup>, when V<sup>+</sup> is greater than 13V or reliability will be adversely affected.
- (7) The maximum power dissipation is a function of T<sub>J(MAX)</sub>, θ<sub>JA</sub>, and T<sub>A</sub>. The maximum allowable power dissipation at any ambient temperature is P<sub>D</sub> = (T<sub>J(MAX)</sub> – T<sub>A</sub>) / θ<sub>JA</sub>. All numbers apply for packages soldered directly into a PC board.

## Operating Ratings <sup>(1)</sup>

Supply Voltage	1.8V ≤ V <sub>S</sub> ≤ 11V	
Junction Temperature Range: LMC6442AI, LMC6442I	–40°C < T <sub>J</sub> < +85°C	
Thermal Resistance (θ <sub>JA</sub> )	D0008A Package, 8-pin Surface Mount	193°C/W
	P0008E Package, 8-pin Molded DIP	115°C/W

- (1) Absolute Maximum Ratings indicate limits beyond which damage to the device may occur. Operating Ratings indicate conditions for which the device is intended to be functional, but specific performance is not ensured. For ensured specifications and the test conditions, see the Electrical Characteristics.

## 2.2V Electrical Characteristics

Unless otherwise specified, all limits ensured for T<sub>J</sub> = 25°C, V<sup>+</sup> = 2.2V, V<sup>-</sup> = 0V, V<sub>CM</sub> = V<sub>O</sub> = V<sup>+</sup>/2, and R<sub>L</sub> = 1 MΩ to V<sup>+</sup>/2.

**Boldface** limits apply at the temperature extremes.

Parameter		Test Conditions	Typ <sup>(1)</sup>	LMC6442AI Limit <sup>(2)</sup>	LMC6442I Limit <sup>(2)</sup>	Units
<b>DC Electrical Characteristics</b>						
V <sub>OS</sub>	Input Offset Voltage		–0.75	±3 ±4	±7 ±8	mV max
TCV <sub>OS</sub>	Temp. coefficient of input offset voltage		0.4			μV/°C
I <sub>B</sub>	Input Bias Current	See <sup>(3)</sup>	0.005	<b>4</b>	<b>4</b>	pA max
I <sub>OS</sub>	Input Offset Current	See <sup>(3)</sup>	0.0025	<b>2</b>	<b>2</b>	pA max
CMRR	Common Mode Rejection Ratio	–0.1V ≤ V <sub>CM</sub> ≤ 0.5V	92	<b>67</b> <b>67</b>	<b>67</b> <b>67</b>	dB min
C <sub>IN</sub>	Common Mode Input Capacitance		4.7			pF
PSRR	Power Supply Rejection Ratio	V <sub>S</sub> = 2.5 V to 10V	95	<b>75</b> <b>75</b>	<b>75</b> <b>75</b>	dB min

- (1) Typical Values represent the most likely parametric norm.
- (2) All limits are specified by testing or statistical analysis unless otherwise specified.
- (3) Limits specified by design.

## 2.2V Electrical Characteristics (continued)

Unless otherwise specified, all limits ensured for  $T_J = 25^\circ\text{C}$ ,  $V^+ = 2.2\text{V}$ ,  $V^- = 0\text{V}$ ,  $V_{\text{CM}} = V_O = V^+/2$ , and  $R_L = 1\text{ M}\Omega$  to  $V^+/2$ .

**Boldface** limits apply at the temperature extremes.

Parameter		Test Conditions	Typ <sup>(1)</sup>	LMC6442AI Limit <sup>(2)</sup>	LMC6442I Limit <sup>(2)</sup>	Units
$V_{\text{CM}}$	Input Common-Mode Voltage Range	CMRR $\geq 50\text{ dB}$	1.3	1.05 <b>0.95</b>	1.05 <b>0.95</b>	V min
			-0.3	-0.2 <b>0</b>	-0.2 <b>0</b>	V max
$A_V$	Large Signal Voltage Gain	Sourcing <sup>(4)</sup>	100			dB min
		Sinking <sup>(4)</sup>	94			
		$V_O = 0.22\text{V}$ to $2\text{V}$	103	80	80	
$V_O$	Output Swing	$V_{\text{ID}} = 100\text{ mV}$ <sup>(5)</sup>	2.18	2.15 <b>2.15</b>	2.15 <b>2.15</b>	V min
		$V_{\text{ID}} = -100\text{ mV}$ <sup>(5)</sup>	22	60 <b>60</b>	60 <b>60</b>	mV max
$I_{\text{SC}}$	Output Short Circuit Current	Sourcing, $V_{\text{ID}} = 100\text{ mV}$ <sup>(6)</sup> <sup>(5)</sup>	50	18 <b>17</b>	18 <b>17</b>	$\mu\text{A}$ min
		Sinking, $V_{\text{ID}} = -100\text{ mV}$ <sup>(6)</sup> <sup>(5)</sup>	50	20 <b>19</b>	20 <b>19</b>	
$I_S$	Supply Current (2 amplifiers)	$R_L = \text{open}$	1.90	2.4 <b>3.0</b>	2.6 <b>3.2</b>	$\mu\text{A}$ max
		$V^+ = 1.8\text{V}$ , $R_L = \text{open}$	2.10			
<b>AC Electrical Characteristics</b>						
SR	Slew Rate <sup>(7)</sup>		2.2			V/ms
GBWP	Gain-Bandwidth Product		9.5			KHz
$\phi_m$	Phase Margin	See <sup>(8)</sup>	63			deg

(4)  $R_L$  connected to  $V^+/2$ . For Sourcing Test,  $V_O > V^+/2$ . For Sinking tests,  $V_O < V^+/2$ .

(5)  $V_{\text{ID}}$  is differential input voltage referenced to inverting input.

(6) Output shorted to ground for sourcing, and shorted to  $V^+$  for sinking short circuit current test.

(7) Slew rate is the slower of the rising and falling slew rates.

(8) See the [Typical Performance Characteristics](#) and [Applications Information](#) sections for more details.

## 5V Electrical Characteristics

Unless otherwise specified, all limits ensured for  $T_J = 25^\circ\text{C}$ ,  $V^+ = 5\text{V}$ ,  $V^- = 0\text{V}$ ,  $V_{\text{CM}} = V_O = V^+/2$ , and  $R_L = 1\text{ M}\Omega$  to  $V^+/2$ .

**Boldface** limits apply at the temperature extremes.

Parameter		Test Conditions	Typ <sup>(1)</sup>	LMC6442AI Limit <sup>(2)</sup>	LMC6442I Limit <sup>(2)</sup>	Units
<b>DC Electrical Characteristics</b>						
$V_{\text{OS}}$	Input Offset Voltage		-0.75	$\pm 3$ <b><math>\pm 4</math></b>	$\pm 7$ <b><math>\pm 8</math></b>	mV max
$\text{TCV}_{\text{OS}}$	Temp. coefficient of input offset voltage		0.4			$\mu\text{V}/^\circ\text{C}$
$I_B$	Input Bias Current	See <sup>(3)</sup>	0.005	<b>4</b>	<b>4</b>	$\mu\text{A}$ max
$I_{\text{OS}}$	Input Offset Current	See <sup>(3)</sup>	0.0025	<b>2</b>	<b>2</b>	$\mu\text{A}$ max
CMRR	Common Mode Rejection Ratio	$-0.1\text{V} \leq V_{\text{CM}} \leq 3.5\text{V}$	102	70 <b>70</b>	70 <b>70</b>	dB min
$C_{\text{IN}}$	Common Mode Input Capacitance		4.1			pF
PSRR	Power Supply Rejection Ratio	$V_S = 2.5\text{V}$ to $10\text{V}$	95	75 <b>75</b>	75 <b>75</b>	dB min

(1) Typical Values represent the most likely parametric norm.

(2) All limits are specified by testing or statistical analysis unless otherwise specified.

(3) Limits specified by design.

## 5V Electrical Characteristics (continued)

Unless otherwise specified, all limits ensured for  $T_J = 25^\circ\text{C}$ ,  $V^+ = 5\text{V}$ ,  $V^- = 0\text{V}$ ,  $V_{\text{CM}} = V_O = V^+/2$ , and  $R_L = 1\text{ M}\Omega$  to  $V^+/2$ .

**Boldface** limits apply at the temperature extremes.

Parameter		Test Conditions	Typ <sup>(1)</sup>	LMC6442AI Limit <sup>(2)</sup>	LMC6442I Limit <sup>(2)</sup>	Units
$V_{\text{CM}}$	Input Common-Mode Voltage Range	CMRR $\geq 50\text{ dB}$	4.1	3.85 <b>3.75</b>	3.85 <b>3.75</b>	V min
			-0.4	-0.2 <b>0</b>	-0.2 <b>0</b>	V max
$A_V$	Large Signal Voltage Gain	Sourcing <sup>(4)</sup>	100			dB min
		Sinking <sup>(4)</sup>	94			
		$V_O = 0.5\text{V}$ to $4.5\text{V}$	103	80	80	
$V_O$	Output Swing	$V_{\text{ID}} = 100\text{ mV}$ <sup>(5)</sup>	4.99	4.95 <b>4.95</b>	4.95 <b>4.95</b>	V min
		$V_{\text{ID}} = -100\text{ mV}$ <sup>(5)</sup>	20	50 <b>50</b>	50 <b>50</b>	mV max
$I_{\text{SC}}$	Output Short Circuit Current	Sourcing, $V_{\text{ID}} = 100\text{ mV}$ <sup>(6)</sup> <sup>(5)</sup>	500	300 <b>200</b>	300 <b>200</b>	$\mu\text{A}$ min
		Sinking, $V_{\text{ID}} = -100\text{ mV}$ <sup>(6)</sup> <sup>(5)</sup>	350	200 <b>150</b>	200 <b>150</b>	
$I_S$	Supply Current (2 amplifiers)	$R_L = \text{open}$	1.90	2.4 <b>3.0</b>	2.6 <b>3.2</b>	$\mu\text{A}$ max
<b>AC Electrical Characteristics</b>						
SR	Slew Rate <sup>(7)</sup>		4.1	2.5	2.5	V/ms
GBWP	Gain-Bandwidth Product		10			KHz
$\phi_m$	Phase Margin	See <sup>(8)</sup>	64			deg
THD	Total Harmonic Distortion	$A_V = +2$ , $f = 100\text{ Hz}$ , $R_L = 10\text{ M}\Omega$ , $V_{\text{OUT}} = 1\text{ V}_{\text{PP}}$	0.08			%

(4)  $R_L$  connected to  $V^+/2$ . For Sourcing Test,  $V_O > V^+/2$ . For Sinking tests,  $V_O < V^+/2$ .

(5)  $V_{\text{ID}}$  is differential input voltage referenced to inverting input.

(6) Output shorted to ground for sourcing, and shorted to  $V^+$  for sinking short circuit current test.

(7) Slew rate is the slower of the rising and falling slew rates.

(8) See the [Typical Performance Characteristics](#) and [Applications Information](#) sections for more details.

## 10V Electrical Characteristics

Unless otherwise specified, all limits ensured for  $T_J = 25^\circ\text{C}$ ,  $V^+ = 10\text{V}$ ,  $V^- = 0\text{V}$ ,  $V_{\text{CM}} = V_O = V^+/2$ , and  $R_L = 1\text{ M}\Omega$  to  $V^+/2$ .

**Boldface** limits apply at the temperature extremes.

Parameter		Test Conditions	Typ <sup>(1)</sup>	LMC6442AI Limit <sup>(2)</sup>	LMC6442I Limit <sup>(2)</sup>	Units
<b>DC Electrical Characteristics</b>						
$V_{\text{OS}}$	Input Offset Voltage		-1.5	$\pm 3$ <b><math>\pm 4</math></b>	$\pm 7$ <b><math>\pm 8</math></b>	mV max
$\text{TCV}_{\text{OS}}$	Temp. coefficient of input offset voltage		0.4			$\mu\text{V}/^\circ\text{C}$
$I_B$	Input Bias Current	See <sup>(3)</sup>	0.005	<b>4</b>	<b>4</b>	$\mu\text{A}$ max
$I_{\text{OS}}$	Input Offset Current	See <sup>(3)</sup>	0.0025	<b>2</b>	<b>2</b>	$\mu\text{A}$ max
CMRR	Common Mode Rejection Ratio	$-0.1\text{V} \leq V_{\text{CM}} \leq 8.5\text{V}$	105	70 <b>70</b>	70 <b>70</b>	dB min
$C_{\text{IN}}$	Common Mode Input Capacitance		3.5			pF
PSRR	Power Supply Rejection Ratio	$V_S = 2.5\text{ V}$ to $10\text{V}$	95	75 <b>75</b>	75 <b>75</b>	dB min

(1) Typical Values represent the most likely parametric norm.

(2) All limits are specified by testing or statistical analysis unless otherwise specified.

(3) Limits specified by design.

## 10V Electrical Characteristics (continued)

Unless otherwise specified, all limits ensured for  $T_J = 25^\circ\text{C}$ ,  $V^+ = 10\text{V}$ ,  $V^- = 0\text{V}$ ,  $V_{\text{CM}} = V_O = V^+/2$ , and  $R_L = 1\text{ M}\Omega$  to  $V^+/2$ .

**Boldface** limits apply at the temperature extremes.

Parameter		Test Conditions	Typ <sup>(1)</sup>	LMC6442AI Limit <sup>(2)</sup>	LMC6442I Limit <sup>(2)</sup>	Units
$V_{\text{CM}}$	Input Common-Mode Voltage Range	CMRR $\geq 50\text{ dB}$	9.1	8.85 <b>8.75</b>	8.85 <b>8.75</b>	V min
			-0.4	-0.2 <b>0</b>	-0.2 <b>0</b>	V max
$A_V$	Large Signal Voltage Gain	Sourcing <sup>(4)</sup>	120			dB min
		Sinking <sup>(4)</sup>	100			
		$V_O = 0.5\text{V to }9.5\text{V}$	104	80	80	
$V_O$	Output Swing	$V_{\text{ID}} = 100\text{ mV}^{(5)}$	9.99	9.97 <b>9.97</b>	9.97 <b>9.97</b>	V min
		$V_{\text{ID}} = -100\text{ mV}^{(5)}$	22	50 <b>50</b>	50 <b>50</b>	mV max
$I_{\text{SC}}$	Output Short Circuit Current	Sourcing, $V_{\text{ID}} = 100\text{ mV}^{(6) (5)}$	2100	1200 <b>1000</b>	1200 <b>1000</b>	$\mu\text{A}$ min
		Sinking, $V_{\text{ID}} = -100\text{ mV}^{(6) (5)}$	900	600 <b>500</b>	600 <b>500</b>	
$I_S$	Supply Current (2 amplifiers)	$R_L = \text{open}$	1.90	2.4 <b>3.0</b>	2.6 <b>3.2</b>	$\mu\text{A}$ max
<b>AC Electrical Characteristics</b>						
SR	Slew Rate <sup>(7)</sup>		4.1	2.5	2.5	V/ms
GBWP	Gain-Bandwidth Product		10.5			KHz
$\phi_m$	Phase Margin	See <sup>(8)</sup>	68			deg
$e_n$	Input-Referred Voltage Noise	$R_L = \text{open}$ $f = 10\text{ Hz}$	170			nV/ $\sqrt{\text{Hz}}$
$i_n$	Input-Referred Current Noise	$R_L = \text{open}$ $f = 10\text{ Hz}$	0.0002			pA/ $\sqrt{\text{Hz}}$
	Crosstalk Rejection	See <sup>(9)</sup>	85			dB

(4)  $R_L$  connected to  $V^+/2$ . For Sourcing Test,  $V_O > V^+/2$ . For Sinking tests,  $V_O < V^+/2$ .

(5)  $V_{\text{ID}}$  is differential input voltage referenced to inverting input.

(6) Output shorted to ground for sourcing, and shorted to  $V^+$  for sinking short circuit current test.

(7) Slew rate is the slower of the rising and falling slew rates.

(8) See the [Typical Performance Characteristics](#) and [Applications Information](#) sections for more details.

(9) Input referred,  $V^+ = 10\text{V}$  and  $R_L = 10\text{ M}\Omega$  connected to  $5\text{V}$ . Each amp excited in turn with  $1\text{ KHz}$  to produce about  $10\text{ V}_{\text{PP}}$  output.

### Typical Performance Characteristics

$V_S = 5V$ , Single Supply,  $T_A = 25^\circ C$  unless otherwise specified

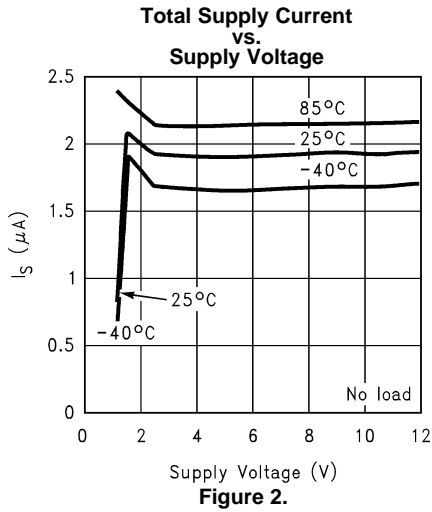

Figure 2.

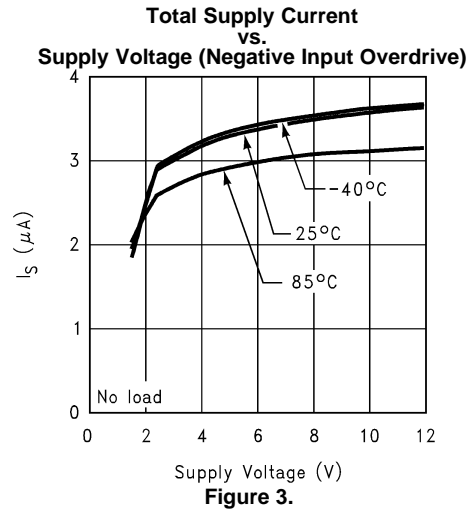

Figure 3.

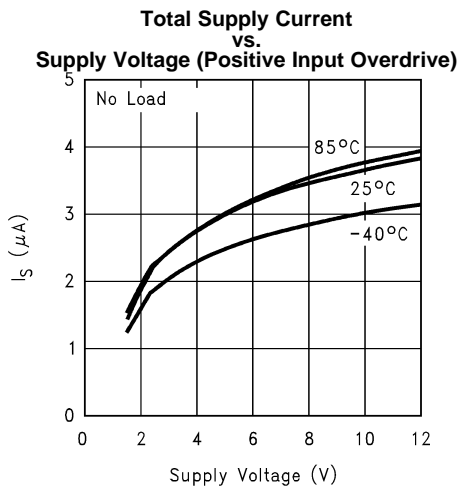

Figure 4.

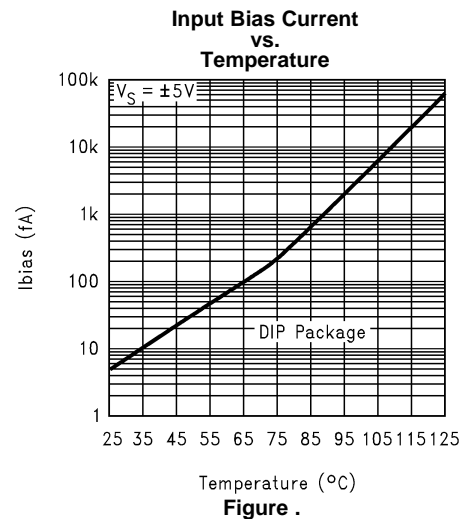

Figure 5.

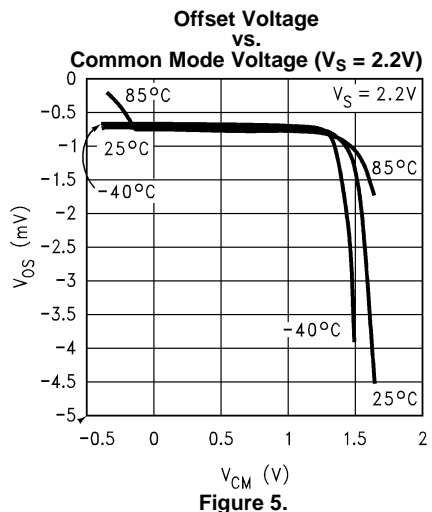

Figure 6.

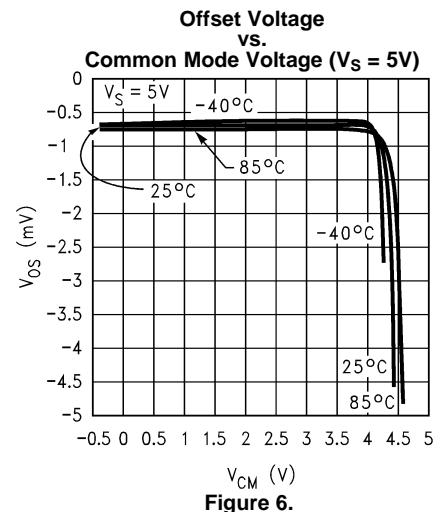

Figure 7.

Typical Performance Characteristics (continued)

$V_S = 5V$ , Single Supply,  $T_A = 25^\circ C$  unless otherwise specified

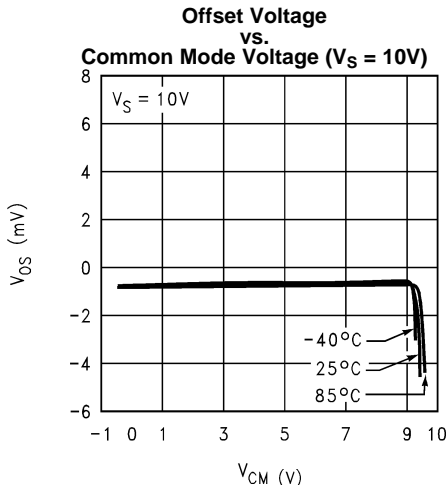

Figure 7.

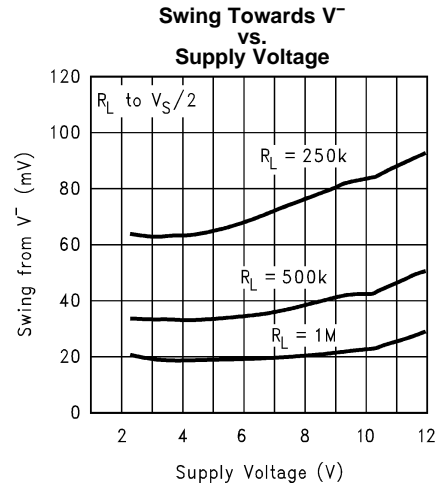

Figure 8.

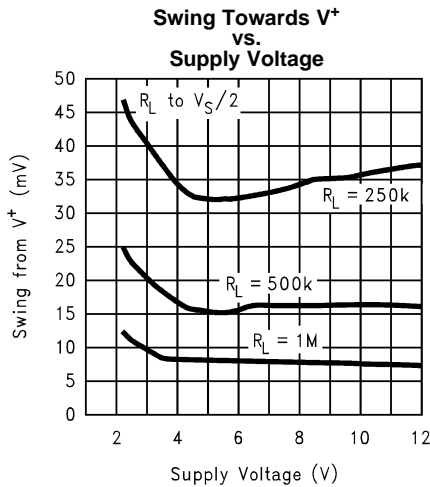

Figure 9.

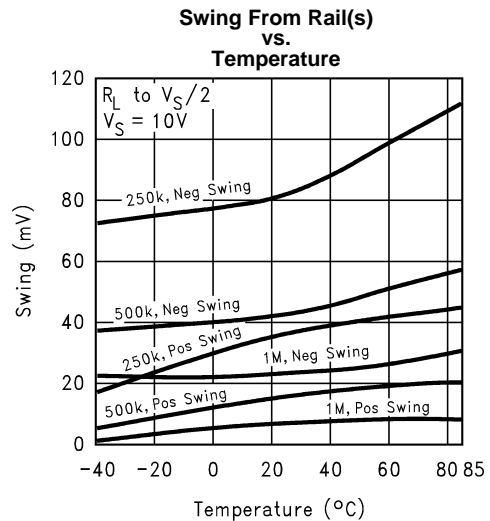

Figure 10.

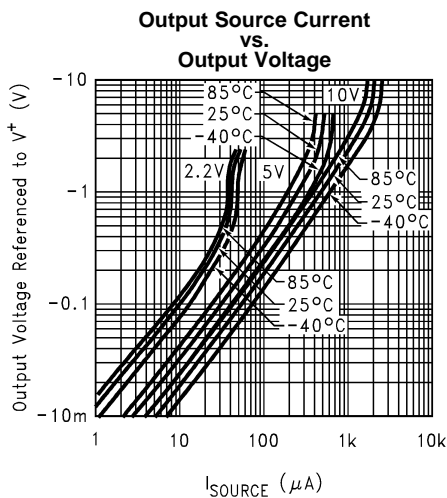

Figure 11.

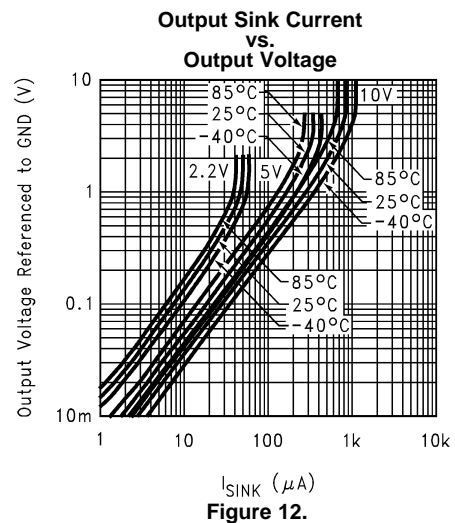

Figure 12.

**Typical Performance Characteristics (continued)**

$V_S = 5V$ , Single Supply,  $T_A = 25^\circ C$  unless otherwise specified

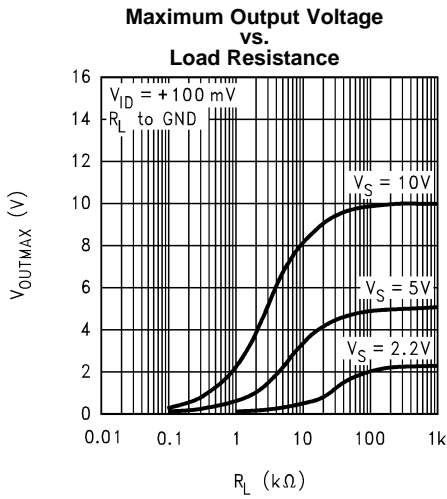

Figure 13.

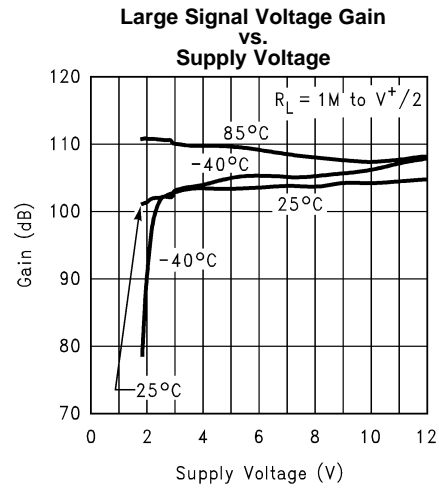

Figure 14.

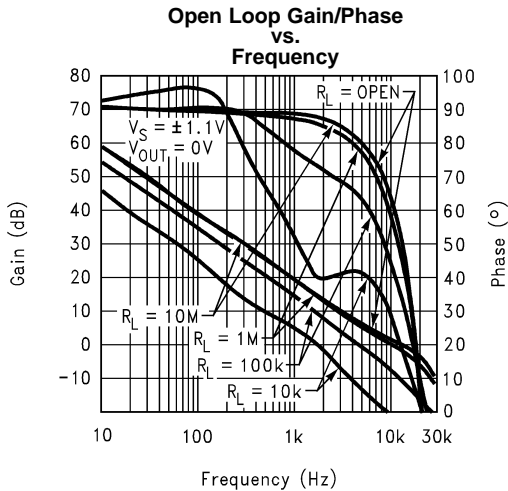

Figure 15.

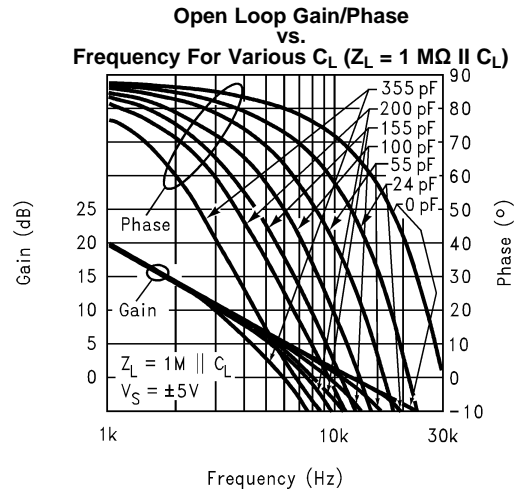

Figure 16.

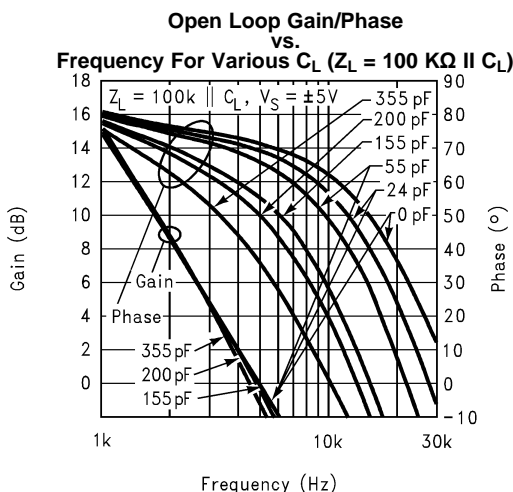

Figure 17.

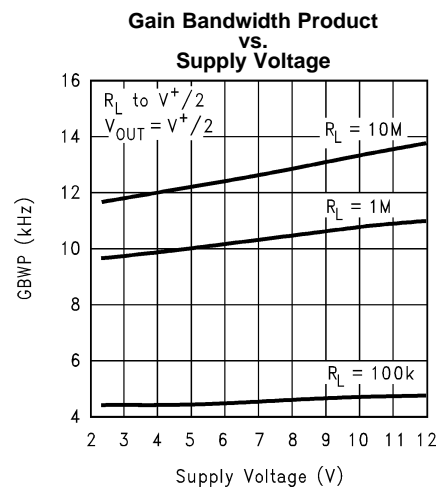

Figure 18.

Typical Performance Characteristics (continued)

$V_S = 5V$ , Single Supply,  $T_A = 25^\circ C$  unless otherwise specified

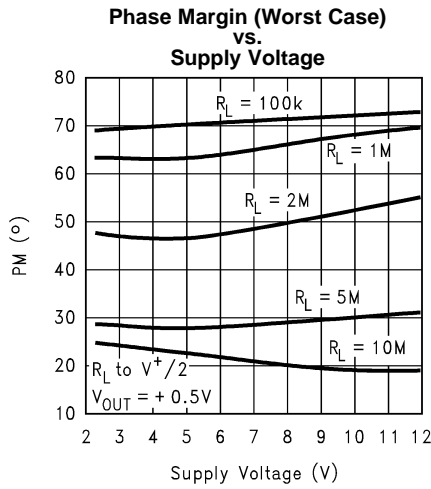

Figure 19.

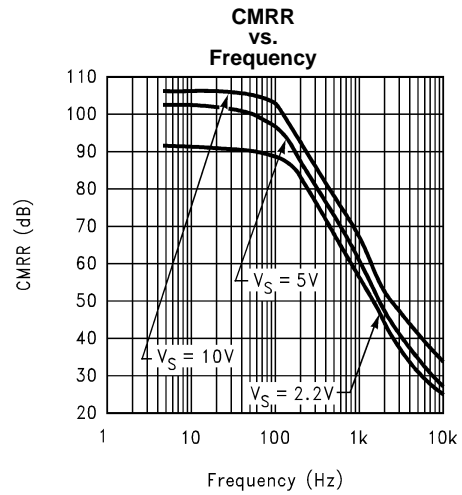

Figure 20.

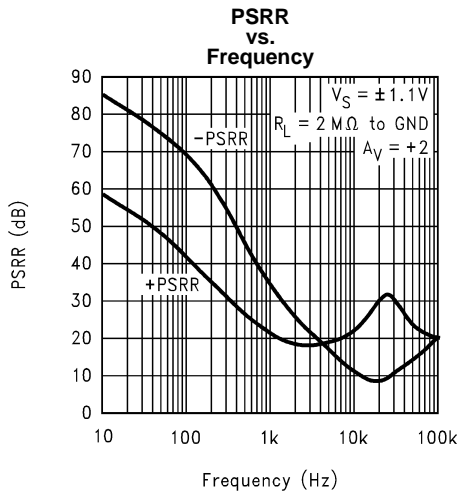

Figure 21.

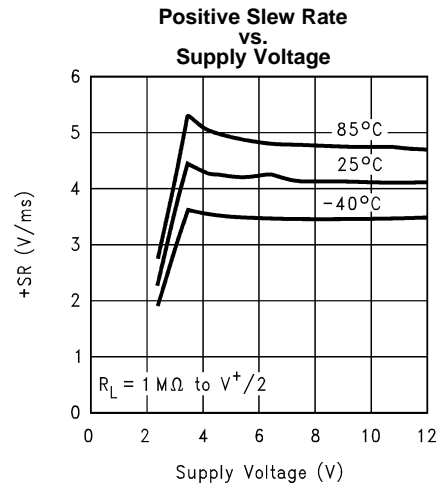

Figure 22.

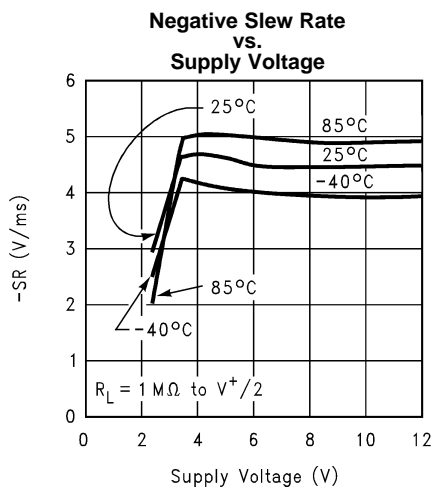

Figure 23.

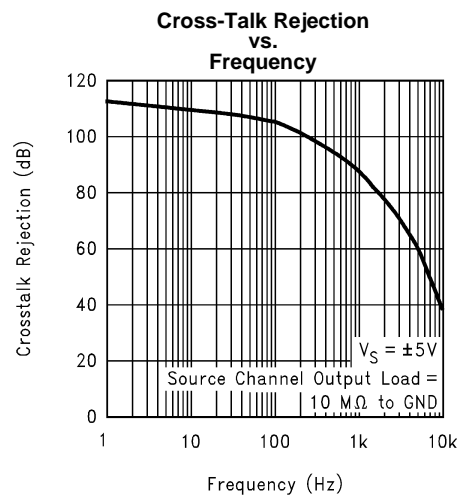
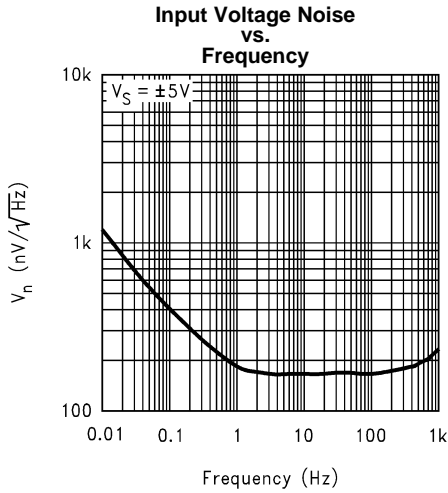

Figure 24.

**Typical Performance Characteristics (continued)**

$V_S = 5V$ , Single Supply,  $T_A = 25^\circ C$  unless otherwise specified



**Figure 25.**

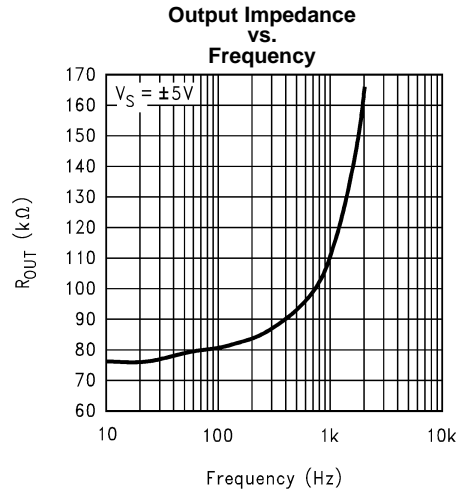

**Figure 26.**

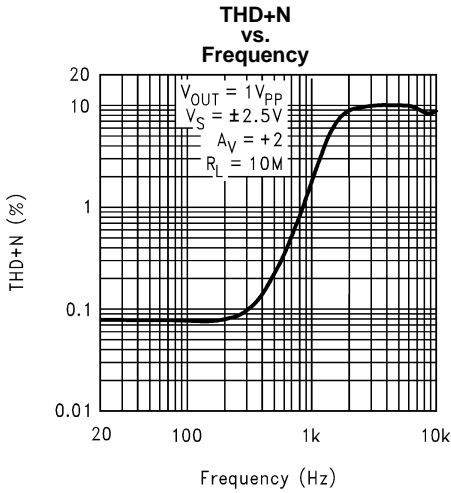

**Figure 27.**

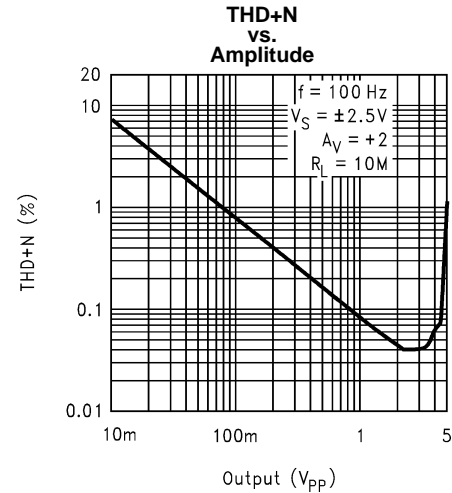

**Figure 28.**

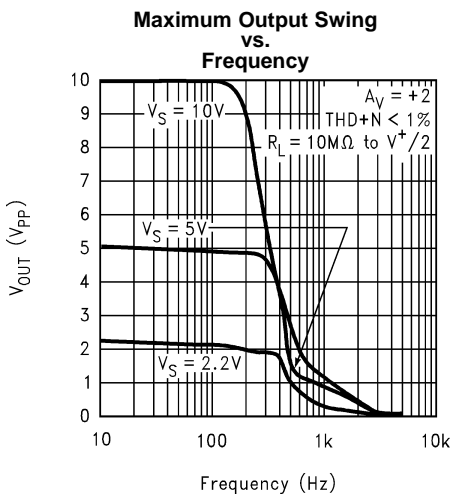

**Figure 29.**

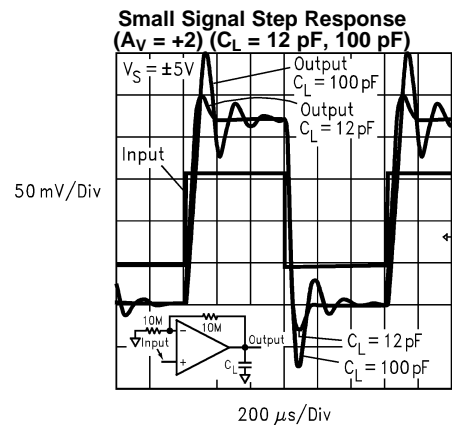

**Figure 30.**

Typical Performance Characteristics (continued)

$V_S = 5V$ , Single Supply,  $T_A = 25^\circ C$  unless otherwise specified

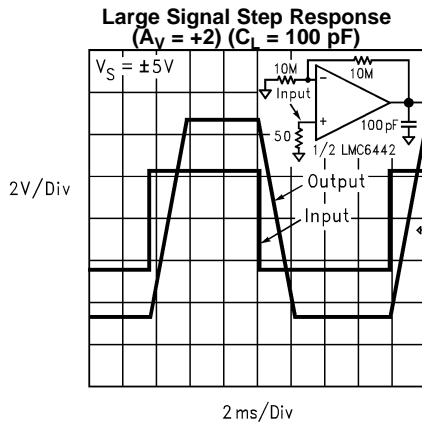

Figure 31.

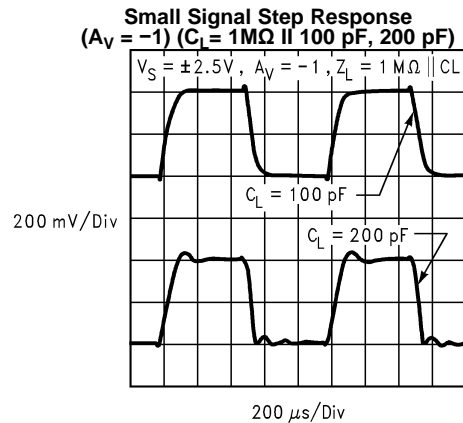

Figure 32.

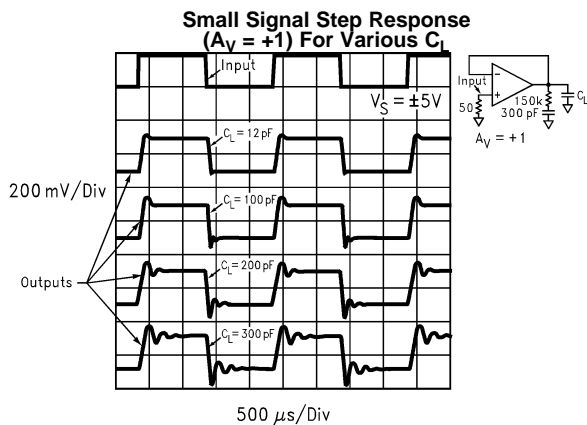

Figure 33.

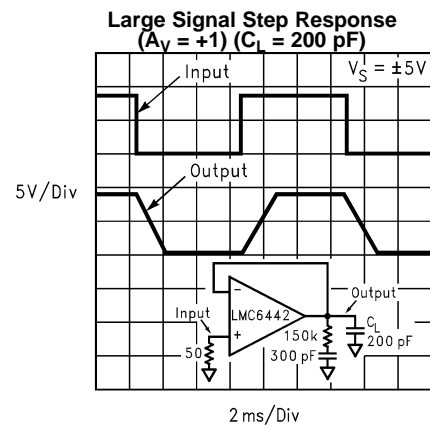
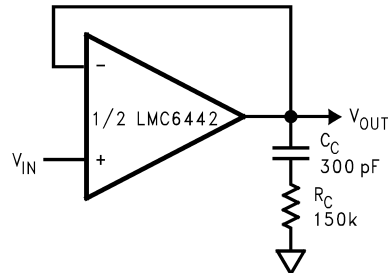

Figure 34.

## APPLICATIONS INFORMATION

### USING LMC6442 IN UNITY GAIN APPLICATIONS

LMC6442 is optimized for maximum bandwidth and minimal external components when operating at a minimum closed loop gain of +2 (or –1). However, it is also possible to operate the device in a unity gain configuration by adding external compensation as shown in [Figure 35](#):



**Figure 35.  $A_V = +1$  Operation by adding  $C_C$  and  $R_C$**

Using this compensation technique it is possible to drive capacitive loads of up to 300 pF without causing oscillations (see the [Typical Performance Characteristics](#) for step response plots). This compensation can also be used with other gain settings in order to improve stability, especially when driving capacitive loads (for optimum performance,  $R_C$  and  $C_C$  may need to be adjusted).

### USING “T” NETWORK

Compromises need to be made whenever high gain inverting stages need to achieve a high input impedance as well. This is especially important in low current applications which tend to deal with high resistance values. Using a traditional inverting amplifier, gain is inversely proportional to the resistor value tied between the inverting terminal and input while the input impedance is equal to this value. For example, in order to build an inverting amplifier with an input impedance of 10M $\Omega$  and a gain of 100, one needs to come up with a feedback resistor of 1000 M $\Omega$  -an expensive task.

An alternate solution is to use a “T” Network in the feedback path, as shown in [Figure 36](#).

Closed loop gain,  $A_V$  is given by:

$$A_V = -\frac{R^2}{R_2} \cdot \left( \frac{2}{R} + \frac{1}{R_1} \right) \quad (1)$$

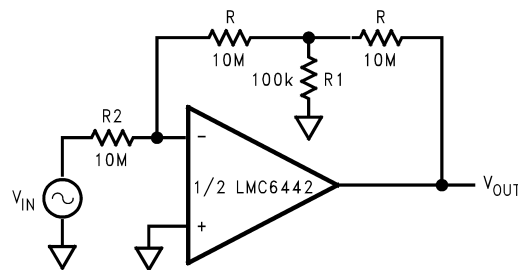

**Figure 36. “T” Network Used to Replace High Value Resistor**

It must be noted, however, that using this scheme, the realizable bandwidth would be less than the theoretical maximum. With feedback factor,  $\beta$ , defined as:

$$\beta \cong \frac{R_2}{R_2 + R} \cdot \frac{R_1}{R_1 + R} \text{ for } R_2 \gg R_1 \quad (2)$$

$$BW(-3 \text{ dB}) \approx GBWP \cdot \beta \quad (3)$$

In this case, assuming a GBWP of about 10 KHz, the expected BW would be around 50 Hz (vs. 100 Hz with the conventional inverting amplifier).

Looking at the problem from a different view, with  $R_F$  defined by  $A_V \bullet R_{in}$ , one could select a value for  $R$  in the “T” Network and then determine  $R_1$  based on this selection:

$$R_1 = \frac{R^2}{R_F - 2R} \quad (4)$$

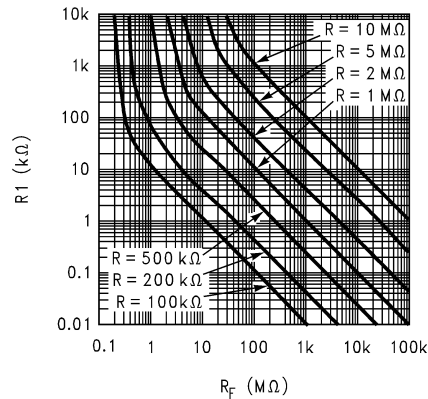

Figure 37. “T” Network Values for Various Values of R

For convenience, Figure 37 shows  $R_1$  vs.  $R_F$  for different values of  $R$ .

## DESIGN CONSIDERATIONS FOR CAPACITIVE LOADS

As with many other opamps, the LMC6442 is more stable at higher closed loop gains when driving a capacitive load. Figure 38 shows minimum closed loop gain versus load capacitance, to achieve less than 10% overshoot in the output small signal response. In addition, the LMC6442 is more stable when it provides more output current to the load and when its output voltage does not swing close to  $V^-$ .

The LMC6442 is more tolerant to capacitive loads when the equivalent output load resistance is lowered or when output voltage is 1V or greater from the  $V^-$  supply. The capacitive load drive capability is also improved by adding an isolating resistor in series with the load and the output of the device. Figure 39 shows the value of this resistor for various capacitive loads ( $A_V = -1$ ), while limiting the output to less than 10 % overshoot.

Referring to the Typical Performance Characteristics plot of Phase Margin (Worst Case) vs. Supply Voltage, note that Phase Margin increases as the equivalent output load resistance is lowered. This plot shows the expected Phase Margin when the device output is very close to  $V^-$ , which is the least stable condition of operation. Comparing this Phase Margin value to the one read off the Open Loop Gain/Phase vs. Frequency plot, one can predict the improvement in Phase Margin if the output does not swing close to  $V^-$ . This dependence of Phase Margin on output voltage is minimized as long as the output load,  $R_L$ , is about 1MΩ or less.

**Output Phase Reversal:** The LMC6442 is immune against this behavior even when the input voltages exceed the common mode voltage range.

**Output Time Delay:** Due to the ultra low power consumption of the device, there could be as long as 2.5 ms of time delay from when power is applied to when the device output reaches its final value.

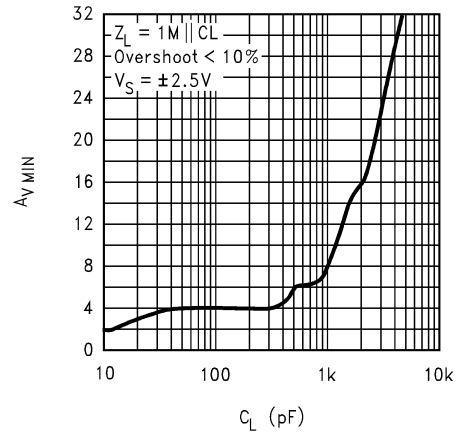

Figure 38. Minimum Operating Gain vs. Capacitive Load

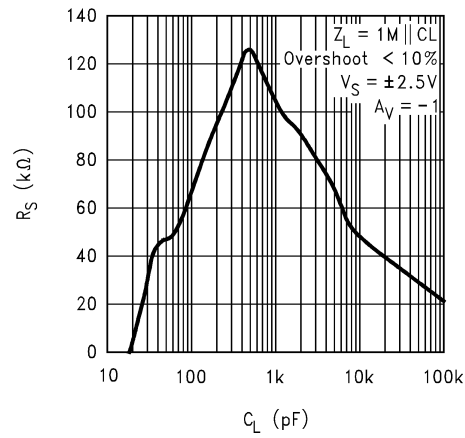
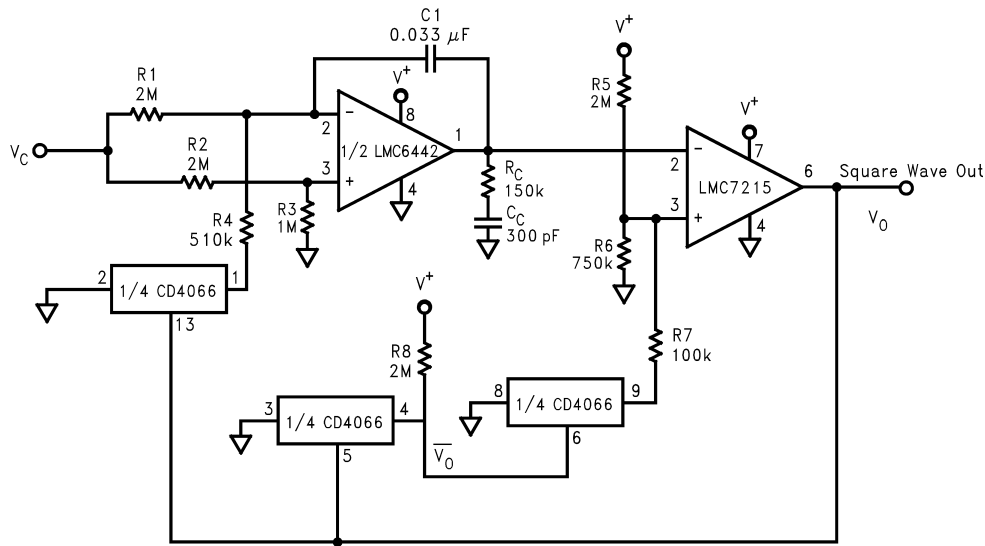

Figure 39. Isolating Resistor Value vs Capacitive Load

Application Circuits



$V^+ = 5V$ ;  $I_S < 10 \mu A$ ,  $f/V_C = 4.3 \text{ (Hz/V)}$

$R1 \cong 4R4$

$R2 = 2R3$

$$f(\text{Hz}) = \frac{V_C}{3R_1 C_1 V^+ \left[ \frac{R_6}{R_5 + R_6} - \frac{(R_6 \parallel R_7)}{(R_6 \parallel R_7) + R_5} \right]} \cong \frac{V_C (R_5 + R_6)}{3R_1 C_1 V^+ (R_6 - R_7)} \text{ for } R_5 \gg R_6 \text{ and } R_6 \gg R_7$$

Figure 40. Micropower Single Supply Voltage to Frequency Converter

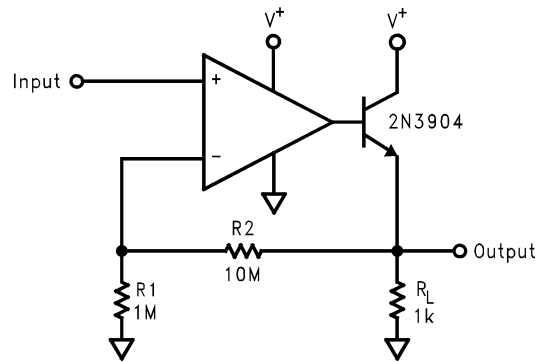
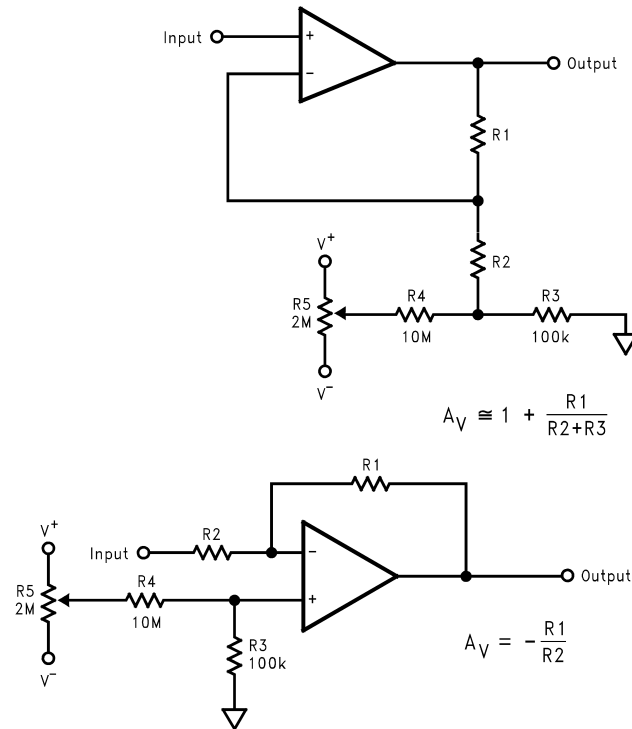

Figure 41. Gain Stage with Current Boosting



**Figure 42. Offset Nulling Schemes**

---

**REVISION HISTORY**

<b>Changes from Revision D (March 2013) to Revision E</b>	<b>Page</b>
<hr/> <ul style="list-style-type: none"><li>• Changed layout of National Data Sheet to TI format .....</li></ul>	<hr/> <a href="#">16</a>

**PACKAGING INFORMATION**

Orderable Device	Status (1)	Package Type	Package Drawing	Pins	Package Qty	Eco Plan (2)	Lead/Ball Finish (6)	MSL Peak Temp (3)	Op Temp (°C)	Device Marking (4/5)	Samples
LMC6442AIM/NOPB	ACTIVE	SOIC	D	8	95	Green (RoHS & no Sb/Br)	CU SN	Level-1-260C-UNLIM	-40 to 85	LMC64 42AIM	<a href="#">Samples</a>
LMC6442AIMX/NOPB	ACTIVE	SOIC	D	8	2500	Green (RoHS & no Sb/Br)	CU SN	Level-1-260C-UNLIM	-40 to 85	LMC64 42AIM	<a href="#">Samples</a>
LMC6442IM/NOPB	ACTIVE	SOIC	D	8	95	Green (RoHS & no Sb/Br)	CU SN	Level-1-260C-UNLIM	-40 to 85	LMC64 42IM	<a href="#">Samples</a>
LMC6442IMX/NOPB	ACTIVE	SOIC	D	8	2500	Green (RoHS & no Sb/Br)	CU SN   Call TI	Level-1-260C-UNLIM	-40 to 85	LMC64 42IM	<a href="#">Samples</a>
LMC6442IN/NOPB	ACTIVE	PDIP	P	8	40	Green (RoHS & no Sb/Br)	CU SN	Level-1-NA-UNLIM	-40 to 85	LMC6442 IN	<a href="#">Samples</a>

(1) The marketing status values are defined as follows:

**ACTIVE:** Product device recommended for new designs.

**LIFEBUY:** TI has announced that the device will be discontinued, and a lifetime-buy period is in effect.

**NRND:** Not recommended for new designs. Device is in production to support existing customers, but TI does not recommend using this part in a new design.

**PREVIEW:** Device has been announced but is not in production. Samples may or may not be available.

**OBSOLETE:** TI has discontinued the production of the device.

(2) Eco Plan - The planned eco-friendly classification: Pb-Free (RoHS), Pb-Free (RoHS Exempt), or Green (RoHS & no Sb/Br) - please check <http://www.ti.com/productcontent> for the latest availability information and additional product content details.

**TBD:** The Pb-Free/Green conversion plan has not been defined.

**Pb-Free (RoHS):** TI's terms "Lead-Free" or "Pb-Free" mean semiconductor products that are compatible with the current RoHS requirements for all 6 substances, including the requirement that lead not exceed 0.1% by weight in homogeneous materials. Where designed to be soldered at high temperatures, TI Pb-Free products are suitable for use in specified lead-free processes.

**Pb-Free (RoHS Exempt):** This component has a RoHS exemption for either 1) lead-based flip-chip solder bumps used between the die and package, or 2) lead-based die adhesive used between the die and leadframe. The component is otherwise considered Pb-Free (RoHS compatible) as defined above.

**Green (RoHS & no Sb/Br):** TI defines "Green" to mean Pb-Free (RoHS compatible), and free of Bromine (Br) and Antimony (Sb) based flame retardants (Br or Sb do not exceed 0.1% by weight in homogeneous material)

(3) MSL, Peak Temp. - The Moisture Sensitivity Level rating according to the JEDEC industry standard classifications, and peak solder temperature.

(4) There may be additional marking, which relates to the logo, the lot trace code information, or the environmental category on the device.

(5) Multiple Device Markings will be inside parentheses. Only one Device Marking contained in parentheses and separated by a "~" will appear on a device. If a line is indented then it is a continuation of the previous line and the two combined represent the entire Device Marking for that device.

<sup>(6)</sup> Lead/Ball Finish - Orderable Devices may have multiple material finish options. Finish options are separated by a vertical ruled line. Lead/Ball Finish values may wrap to two lines if the finish value exceeds the maximum column width.

**Important Information and Disclaimer:**The information provided on this page represents TI's knowledge and belief as of the date that it is provided. TI bases its knowledge and belief on information provided by third parties, and makes no representation or warranty as to the accuracy of such information. Efforts are underway to better integrate information from third parties. TI has taken and continues to take reasonable steps to provide representative and accurate information but may not have conducted destructive testing or chemical analysis on incoming materials and chemicals. TI and TI suppliers consider certain information to be proprietary, and thus CAS numbers and other limited information may not be available for release.

In no event shall TI's liability arising out of such information exceed the total purchase price of the TI part(s) at issue in this document sold by TI to Customer on an annual basis.

## TAPE AND REEL INFORMATION



### QUADRANT ASSIGNMENTS FOR PIN 1 ORIENTATION IN TAPE



\*All dimensions are nominal

Device	Package Type	Package Drawing	Pins	SPQ	Reel Diameter (mm)	Reel Width W1 (mm)	A0 (mm)	B0 (mm)	K0 (mm)	P1 (mm)	W (mm)	Pin1 Quadrant
LMC6442AIMX/NOPB	SOIC	D	8	2500	330.0	12.4	6.5	5.4	2.0	8.0	12.0	Q1
LMC6442IMX/NOPB	SOIC	D	8	2500	330.0	12.4	6.5	5.4	2.0	8.0	12.0	Q1

**TAPE AND REEL BOX DIMENSIONS**

\*All dimensions are nominal

Device	Package Type	Package Drawing	Pins	SPQ	Length (mm)	Width (mm)	Height (mm)
LMC6442AIMX/NOPB	SOIC	D	8	2500	367.0	367.0	35.0
LMC6442IMX/NOPB	SOIC	D	8	2500	367.0	367.0	35.0



D0008A

# PACKAGE OUTLINE

SOIC - 1.75 mm max height

SMALL OUTLINE INTEGRATED CIRCUIT



## NOTES:

1. Linear dimensions are in inches [millimeters]. Dimensions in parenthesis are for reference only. Controlling dimensions are in inches. Dimensioning and tolerancing per ASME Y14.5M.
2. This drawing is subject to change without notice.
3. This dimension does not include mold flash, protrusions, or gate burrs. Mold flash, protrusions, or gate burrs shall not exceed .006 [0.15] per side.
4. This dimension does not include interlead flash.
5. Reference JEDEC registration MS-012, variation AA.

# EXAMPLE BOARD LAYOUT

D0008A

SOIC - 1.75 mm max height

SMALL OUTLINE INTEGRATED CIRCUIT



LAND PATTERN EXAMPLE  
EXPOSED METAL SHOWN  
SCALE:8X



SOLDER MASK DETAILS

4214825/C 02/2019

NOTES: (continued)

6. Publication IPC-7351 may have alternate designs.

7. Solder mask tolerances between and around signal pads can vary based on board fabrication site.

# EXAMPLE STENCIL DESIGN

D0008A

SOIC - 1.75 mm max height

SMALL OUTLINE INTEGRATED CIRCUIT



SOLDER PASTE EXAMPLE  
BASED ON .005 INCH [0.125 MM] THICK STENCIL  
SCALE:8X

4214825/C 02/2019

NOTES: (continued)

8. Laser cutting apertures with trapezoidal walls and rounded corners may offer better paste release. IPC-7525 may have alternate design recommendations.
9. Board assembly site may have different recommendations for stencil design.

P (R-PDIP-T8)

PLASTIC DUAL-IN-LINE PACKAGE



- NOTES:
- A. All linear dimensions are in inches (millimeters).
  - B. This drawing is subject to change without notice.
  - C. Falls within JEDEC MS-001 variation BA.

## IMPORTANT NOTICE AND DISCLAIMER

TI PROVIDES TECHNICAL AND RELIABILITY DATA (INCLUDING DATASHEETS), DESIGN RESOURCES (INCLUDING REFERENCE DESIGNS), APPLICATION OR OTHER DESIGN ADVICE, WEB TOOLS, SAFETY INFORMATION, AND OTHER RESOURCES "AS IS" AND WITH ALL FAULTS, AND DISCLAIMS ALL WARRANTIES, EXPRESS AND IMPLIED, INCLUDING WITHOUT LIMITATION ANY IMPLIED WARRANTIES OF MERCHANTABILITY, FITNESS FOR A PARTICULAR PURPOSE OR NON-INFRINGEMENT OF THIRD PARTY INTELLECTUAL PROPERTY RIGHTS.

These resources are intended for skilled developers designing with TI products. You are solely responsible for (1) selecting the appropriate TI products for your application, (2) designing, validating and testing your application, and (3) ensuring your application meets applicable standards, and any other safety, security, or other requirements. These resources are subject to change without notice. TI grants you permission to use these resources only for development of an application that uses the TI products described in the resource. Other reproduction and display of these resources is prohibited. No license is granted to any other TI intellectual property right or to any third party intellectual property right. TI disclaims responsibility for, and you will fully indemnify TI and its representatives against, any claims, damages, costs, losses, and liabilities arising out of your use of these resources.

TI's products are provided subject to TI's Terms of Sale ([www.ti.com/legal/termsofsale.html](http://www.ti.com/legal/termsofsale.html)) or other applicable terms available either on [ti.com](http://ti.com) or provided in conjunction with such TI products. TI's provision of these resources does not expand or otherwise alter TI's applicable warranties or warranty disclaimers for TI products.

Mailing Address: Texas Instruments, Post Office Box 655303, Dallas, Texas 75265  
Copyright © 2019, Texas Instruments Incorporated

## Looking for pricing, stock, or lifecycle information?

Click below to explore more details on WIN SOURCE:

 [View LMC6442IMX/NOPB on WIN SOURCE](#)

 [Texas Instruments](#) Information

## Optimize Your Supply Chain with WIN SOURCE Solutions

-  Global Sourcing Solution
-  Obsolete Management
-  Cost Control Management
-  Shortage Management
-  Alternative Solution
-  Excess Inventory Management