



THE DATASHEET OF LMC6482AIM



LMC6482 CMOS Dual Rail-to-Rail Input and Output Operational Amplifier

1 Features

- Typical Unless Otherwise Noted
- Rail-to-Rail Input Common-Mode Voltage Range (Ensured Over Temperature)
- Rail-to-Rail Output Swing (Within 20-mV of Supply Rail, 100-k Ω Load)
- Ensured 3-V, 5-V, and 15-V Performance
- Excellent CMRR and PSRR: 82 dB
- Ultralow Input Current: 20 fA
- High Voltage Gain (R_L = 500 k Ω): 130 dB
- Specified for 2-k Ω and 600- Ω Loads
- Power-Good Output
- Available in VSSOP Package

2 Applications

- Data Acquisition Systems
- Transducer Amplifiers
- Hand-held Analytic Instruments
- Medical Instrumentation
- Active Filter, Peak Detector, Sample and Hold, pH Meter, Current Source
- Improved Replacement for TLC272, TLC277

3 Description

The LMC6482 device provides a common-mode range that extends to both supply rails. This rail-to-rail performance combined with excellent accuracy, due to a high CMRR, makes it unique among rail-to-rail input amplifiers. The device is ideal for systems, such as data acquisition, that require a large input signal range. The LMC6482 is also an excellent upgrade for circuits using limited common-mode range amplifiers such as the TLC272 and TLC277.

Maximum dynamic signal range is assured in low voltage and single supply systems by the rail-to-rail output swing of the LMC6482. The rail-to-rail output swing is ensured for loads down to 600 Ω of the device. Ensured low-voltage characteristics and low-power dissipation make the LMC6482 especially well-suited for battery-operated systems. LMC6482 is also available in a VSSOP package, which is almost half the size of a SOIC-8 device. See the LMC6484 data sheet for a quad CMOS operational amplifier with these same features.

Device Information⁽¹⁾

PART NUMBER	PACKAGE	BODY SIZE (NOM)
LMC6482	SOIC (8)	4.90 mm x 3.91 mm
	VSSOP (8)	3.00 mm x 3.00 mm
	PDIP (8)	9.81 mm x 6.35 mm

(1) For all available packages, see the orderable addendum at the end of the data sheet.

Rail-to-Rail Input

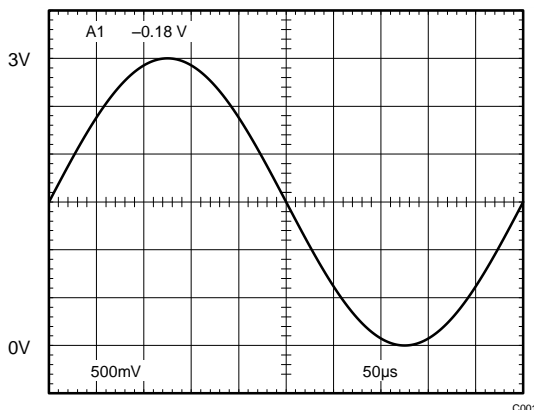

Rail-to-Rail Output

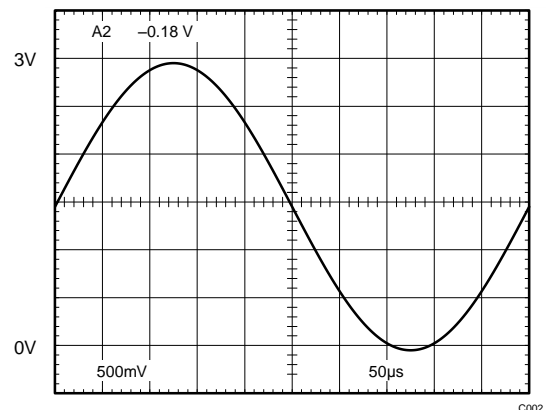

Table of Contents

1 Features 1 2 Applications 1 3 Description 1 4 Revision History 2 5 Pin Configuration and Functions 3 6 Specifications 3 6.1 Absolute Maximum Ratings 3 6.2 ESD Ratings..... 4 6.3 Recommended Operating Conditions 4 6.4 Thermal Information 4 6.5 Electrical Characteristics for $V^+ = 5\text{ V}$ 4 6.6 Electrical Characteristics for $V^+ = 3\text{ V}$ 7 6.7 Typical Characteristics 9 7 Detailed Description 18 7.1 Overview 18	7.2 Functional Block Diagram 18 7.3 Feature Description..... 18 7.4 Device Functional Modes..... 19 8 Application and Implementation 20 8.1 Application Information..... 20 8.2 Typical Applications 22 9 Power Supply Recommendations 28 10 Layout 28 10.1 Layout Guidelines 28 10.2 Layout Example 28 11 Device and Documentation Support 30 11.1 Trademarks 30 11.2 Electrostatic Discharge Caution..... 30 11.3 Glossary 30 12 Mechanical, Packaging, and Orderable Information 30
-------------------------------------------------------------------------------------------------------------------------------------------------------------------------------------------------------------------------------------------------------------------------------------------------------------------------------------------------------------------------------------------------------------------------------------------------------------------------------------------------------------------------------------------------------------------------------------------------------------------------	---------------------------------------------------------------------------------------------------------------------------------------------------------------------------------------------------------------------------------------------------------------------------------------------------------------------------------------------------------------------------------------------------------------------------------------------------------------------------------------------------------------------------------------------------------------------------------------------------------------------------------------

4 Revision History

NOTE: Page numbers for previous revisions may differ from page numbers in the current version.

Changes from Revision D (March 2013) to Revision E	Page
<ul style="list-style-type: none"> • Added <i>Pin Configuration and Functions</i> section, <i>ESD Ratings</i> table, <i>Feature Description</i> section, <i>Device Functional Modes</i>, <i>Application and Implementation</i> section, <i>Power Supply Recommendations</i> section, <i>Layout</i> section, <i>Device and Documentation Support</i> section, and <i>Mechanical, Packaging, and Orderable Information</i> section 	1

Changes from Revision C (March 2013) to Revision D	Page
<ul style="list-style-type: none"> • Changed layout of National Data Sheet to TI format 	27

5 Pin Configuration and Functions

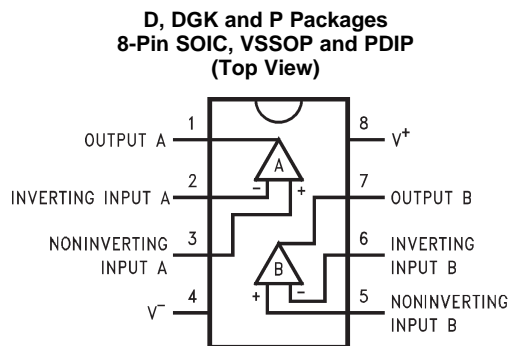

Pin Functions

PIN		TYPE	DESCRIPTION
NO.	NAME		
1	OUTPUT A	O	Output for Amplifier A
2	INVERTING INPUT A	I	Inverting input for Amplifier A
3	NONINVERTING INPUT A	I	Noninverting input for Amplifier A
4	V ⁻	P	Negative supply voltage input
5	NONINVERTING INPUT B	I	Noninverting input for Amplifier B
6	INVERTING INPUT B	I	Inverting input for Amplifier B
7	OUTPUT B	O	Output for Amplifier B
8	V ⁺	P	Positive supply voltage input

6 Specifications

6.1 Absolute Maximum Ratings

over operating free-air temperature range (unless otherwise noted)⁽¹⁾⁽²⁾

	MIN	MAX	UNIT
Differential Input Voltage	±Supply Voltage		
Voltage at Input/Output Pin	(V ⁻) -0.3	(V ⁺) +0.3	V
Supply Voltage (V ⁺ - V ⁻)	16		V
Current at Input Pin ⁽³⁾	-5	5	mA
Current at Output Pin ⁽⁴⁾⁽⁵⁾	-30	30	mA
Current at Power Supply Pin	40		mA
Lead Temperature (Soldering, 10 sec.)	260		°C
Junction Temperature ⁽⁶⁾	150		°C
Storage temperature, T _{stg}	-65	150	°C

- (1) Stresses beyond those listed under *Absolute Maximum Ratings* may cause permanent damage to the device. These are stress ratings only, which do not imply functional operation of the device at these or any other conditions beyond those indicated under *Recommended Operating Conditions*. Exposure to absolute-maximum-rated conditions for extended periods may affect device reliability.
- (2) If Military/Aerospace specified devices are required, please contact the TI Sales Office/Distributors for availability and specifications.
- (3) Limiting input pin current is only necessary for input voltages that exceed absolute maximum input voltage ratings.
- (4) Applies to both single-supply and split-supply operation. Continuous short circuit operation at elevated ambient temperature can result in exceeding the maximum allowed junction temperature of 150°C. Output currents in excess of ±30 mA over long term may adversely affect reliability.
- (5) Do not short circuit output to V⁺, when V⁺ is greater than 13 V or reliability will be adversely affected.
- (6) The maximum power dissipation is a function of T_{J(max)}, R_{θJA}, and T_A. The maximum allowable power dissipation at any ambient temperature is P_D = (T_{J(max)} - T_A)/θ_{JA}. All numbers apply for packages soldered directly into a PC board.

LMC6482

SNOS674E –NOVEMBER 1997–REVISED APRIL 2015

www.ti.com

6.2 ESD Ratings

		VALUE	UNIT
$V_{(ESD)}$	Electrostatic discharge	Human-body model (HBM), per ANSI/ESDA/JEDEC JS-001 ⁽¹⁾	±1500 V

(1) JEDEC document JEP155 states that 500-V HBM allows safe manufacturing with a standard ESD control process.

6.3 Recommended Operating Conditions

over operating free-air temperature range (unless otherwise noted)⁽¹⁾

		MIN	MAX	UNIT
Supply Voltage		3	15.5	V
Junction Temperature Range	LMC6482AM	-55	125	°C
	LMC6482AI, LMC6482I	-40	-85	°C

(1) Stresses beyond those listed under *Absolute Maximum Ratings* may cause permanent damage to the device. These are stress ratings only, which do not imply functional operation of the device at these or any other conditions beyond those indicated under *Recommended Operating Conditions*. Exposure to absolute-maximum-rated conditions for extended periods may affect device reliability.

6.4 Thermal Information

THERMAL METRIC ⁽¹⁾	LMC6482	LMC6482	LMC6482	UNIT
	D (SOIC)	DGK (VSSOP)	P (PDIP)	
	8 PINS	8 PINS	8 PINS	
$R_{\theta JA}$ Junction-to-ambient thermal resistance	155	194	90	°C/W

(1) For more information about traditional and new thermal metrics, see the *IC Package Thermal Metrics* application report, [SPRA953](#).

6.5 Electrical Characteristics for $V^+ = 5\text{ V}$

Unless otherwise specified, all limits specified for $T_J = 25^\circ\text{C}$, $V^+ = 5\text{ V}$, $V^- = 0\text{ V}$, $V_{CM} = V_O = V^+/2$ and $R_L > 1\text{ M}\Omega$.

PARAMETER	TEST CONDITIONS	$T_J = 25^\circ\text{C}$			At Temperature Extremes ⁽¹⁾			UNIT
		MIN	TYP ⁽²⁾	MAX ⁽³⁾	MIN	TYP ⁽²⁾	MAX ⁽³⁾	
DC Electrical Characteristics								
V_{OS} Input Offset Voltage		LMC6482AI	0.11	0.75			1.35	mV
		LMC6482I	0.11	3			3.7	
		LMC6482M	0.11	3			3.8	
TCV_{OS} Input Offset Voltage Average Drift			1					$\mu\text{V}/^\circ\text{C}$
I_B Input Current	See ⁽⁴⁾	LMC6482AI	0.02				4	pA
		LMC6482I	0.02				4	
		LMC6482M	0.02				10	
I_{OS} Input Offset Current	See ⁽⁴⁾	LMC6482AI	0.01				2	pA
		LMC6482I	0.01				2	
		LMC6482M	0.01				5	
C_{IN} Common-Mode Input Capacitance			3					pF
R_{IN} Input Resistance			10					Tera Ω

(1) See [Recommended Operating Conditions](#) for operating temperature ranges.

(2) Typical Values represent the most likely parametric norm.

(3) All limits are specified by testing or statistical analysis.

(4) Ensured limits are dictated by tester limitations and not device performance. Actual performance is reflected in the typical value.

Electrical Characteristics for $V^+ = 5\text{ V}$ (continued)

Unless otherwise specified, all limits specified for $T_J = 25^\circ\text{C}$, $V^+ = 5\text{ V}$, $V^- = 0\text{ V}$, $V_{CM} = V_O = V^+/2$ and $R_L > 1\text{ M}$.

PARAMETER	TEST CONDITIONS		$T_J = 25^\circ\text{C}$			At Temperature Extremes ⁽¹⁾			UNIT
			MIN	TYP ⁽²⁾	MAX ⁽³⁾	MIN	TYP ⁽²⁾	MAX ⁽³⁾	
CMRR Common-Mode Rejection Ratio	$0\text{ V} \leq V_{CM} \leq 15\text{ V}$ $V^+ = 15\text{ V}$	LMC6482AI	70	82		67		dB	
		LMC6482I	65	82		62			
		LMC6482M	65	82		60			
	$0\text{ V} \leq V_{CM} \leq 5\text{ V}$ $V^+ = 5\text{ V}$	LMC6482AI	70	82		67			
		LMC6482I	65	82		62			
		LMC6482M	65	82		60			
+PSRR Positive Power Supply Rejection Ratio	$5\text{ V} \leq V^+ \leq 15\text{ V}$, $V^- = 0\text{ V}$ $V_O = 2.5\text{ V}$	LMC6482AI	70	82		67		dB	
		LMC6482I	65	82		62			
		LMC6482M	65	82		60			
-PSRR Negative Power Supply Rejection Ratio	$-5\text{ V} \leq V^- \leq -15\text{ V}$, $V^+ = 0\text{ V}$ $V_O = -2.5\text{ V}$	LMC6482AI	70	82		67		dB	
		LMC6482I	65	82		62			
		LMC6482M	65	82		60			
V_{CM} Input Common-Mode Voltage Range	$V^+ = 5\text{ V}$ and 15 V For CMRR $\geq 50\text{ dB}$	LMC6482AI		$V^- - 0.3$	-0.25			V	
		LMC6482I		$V^- - 0.3$	-0.25		0		
		LMC6482M		$V^- - 0.3$	-0.25		0		
		LMC6482AI	$V^+ + 0.25$	$V^+ + 0.3$		V^+		V	
		LMC6482I	$V^+ + 0.25$	$V^+ + 0.3$		V^+			
		LMC6482M	$V^+ + 0.25$	$V^+ + 0.3$		V^+			
A_V Large Signal Voltage Gain	$R_L = 2\text{ k}\Omega$ ⁽⁵⁾⁽⁴⁾	Sourcing	LMC6482AI	140	666		84	V/mV	
			LMC6482I	120	666		72		
			LMC6482M	120	666		60		
		Sinking	LMC6482AI	35	75		20	V/mV	
			LMC6482I	35	75		20		
			LMC6482M	35	75		18		
	$R_L = 600\ \Omega$ ⁽⁵⁾⁽⁴⁾	Sourcing	LMC6482AI	80	300		48	V/mV	
			LMC6482I	50	300		30		
			LMC6482M	50	300		25		
		Sinking	LMC6482AI	20	35		13	V/mV	
			LMC6482I	15	35		10		
			LMC6482M	15	35		8		

(5) $V^+ = 15\text{ V}$, $V_{CM} = 7.5\text{ V}$ and R_L connected to 7.5 V . For Sourcing tests, $7.5\text{ V} \leq V_O \leq 11.5\text{ V}$. For Sinking tests, $3.5\text{ V} \leq V_O \leq 7.5\text{ V}$.

Electrical Characteristics for $V^+ = 5\text{ V}$ (continued)

Unless otherwise specified, all limits specified for $T_J = 25^\circ\text{C}$, $V^+ = 5\text{ V}$, $V^- = 0\text{ V}$, $V_{CM} = V_O = V^+/2$ and $R_L > 1\text{ M}$.

PARAMETER	TEST CONDITIONS	$T_J = 25^\circ\text{C}$			At Temperature Extremes ⁽¹⁾			UNIT	
		MIN	TYP ⁽²⁾	MAX ⁽³⁾	MIN	TYP ⁽²⁾	MAX ⁽³⁾		
V_O Output Swing	$V^+ = 5\text{ V}$ $R_L = 2\text{ k}\Omega$ to $V^+/2$	LMC6482AI	4.8	4.9	4.7		V		
		LMC6482I	4.8	4.9	4.7				
		LMC6482M	4.8	4.9	4.7				
		$V^+ = 5\text{ V}$ $R_L = 600\ \Omega$ to $V^+/2$	LMC6482AI		0.1	0.18	0.24		V
			LMC6482I		0.1	0.18	0.24		
			LMC6482M		0.1	0.18	0.24		
	$V^+ = 5\text{ V}$ $R_L = 600\ \Omega$ to $V^+/2$		LMC6482AI	4.5	4.7	4.24		V	
			LMC6482I	4.5	4.7	4.24			
			LMC6482M	4.5	4.7	4.24			
		LMC6482AI		0.3	0.5	0.65			
		LMC6482I		0.3	0.5	0.65			
		LMC6482M		0.3	0.5	0.65			
	$V^+ = 15\text{ V}$ $R_L = 2\text{ k}\Omega$ to $V^+/2$	LMC6482AI	14.4	14.7	14.2		V		
		LMC6482I	14.4	14.7	14.2				
		LMC6482M	14.4	14.7	14.2				
		LMC6482AI		0.16	0.32	0.45			
		LMC6482I		0.16	0.32	0.45			
		LMC6482M		0.16	0.32	0.45			
	$V^+ = 15\text{ V}$ $R_L = 600\ \Omega$ to $V^+/2$	LMC6482AI	13.4	14.1	13		V		
		LMC6482I	13.4	14.1	13				
		LMC6482M	13.4	14.1	13				
		LMC6482AI		0.5	1	1.3		V	
			LMC6482I		0.5	1	1.3		
			LMC6482M		0.5	1	1.3		
I_{SC} Output Short Circuit Current $V^+ = 5\text{ V}$	Sourcing, $V_O = 0\text{ V}$	LMC6482AI	16	20	12		mA		
		LMC6482I	16	20	12				
		LMC6482M	16	20	10				
	Sinking, $V_O = 5\text{ V}$	LMC6482AI	11	15	9.5		mA		
		LMC6482I	11	15	9.5				
		LMC6482M	11	15	8				
I_{SC} Output Short Circuit Current $V^+ = 15\text{ V}$	Sourcing, $V_O = 0\text{ V}$	LMC6482AI	28	30	22		mA		
		LMC6482I	28	30	22				
		LMC6482M	28	30	20				
	Sinking, $V_O = 12\text{ V}$ ⁽⁶⁾	LMC6482AI	30	30	24		mA		
		LMC6482I	30	30	24				
		LMC6482M	30	30	22				
I_S Supply Current	Both Amplifiers $V^+ = +5\text{ V}$, $V_O = V^+/2$	LMC6482AI		1	1.4	1.8		mA	
		LMC6482I		1	1.4	1.8			
		LMC6482M		1	1.4	1.9			
	Both Amplifiers $V^+ = 15\text{ V}$, $V_O = V^+/2$	LMC6482AI		1.3	1.6	1.9		mA	
		LMC6482I		1.3	1.6	1.9			
		LMC6482M		1.3	1.6	2			

(6) Do not short circuit output to V^+ , when V^+ is greater than 13 V or reliability will be adversely affected.

Electrical Characteristics for $V^+ = 5\text{ V}$ (continued)

Unless otherwise specified, all limits specified for $T_J = 25^\circ\text{C}$, $V^+ = 5\text{ V}$, $V^- = 0\text{ V}$, $V_{CM} = V_O = V^+/2$ and $R_L > 1\text{ M}$.

PARAMETER	TEST CONDITIONS	$T_J = 25^\circ\text{C}$			At Temperature Extremes ⁽¹⁾			UNIT	
		MIN	TYP ⁽²⁾	MAX ⁽³⁾	MIN	TYP ⁽²⁾	MAX ⁽³⁾		
AC Electrical Characteristics									
SR	Slew Rate	See ⁽⁷⁾	LMC6482AI	1	1.3	0.7			$\text{V}/\mu\text{s}$
			LMC6482I	0.9	1.3	0.63			$\text{V}/\mu\text{s}$
			LMC6482M	0.9	1.3	0.54			$\text{V}/\mu\text{s}$
GBW	Gain-Bandwidth Product	$V^+ = 15\text{ V}$		1.5				MHz	
ϕ_m	Phase Margin			50				Deg	
G_m	Gain Margin			15				dB	
	Amp-to-Amp Isolation	See ⁽⁸⁾		150				dB	
e_n	Input-Referred Voltage Noise	$F = 1\text{ kHz}$ $V_{cm} = 1\text{ V}$		37				$\text{nV}/\sqrt{\text{Hz}}$	
I_n	Input-Referred Current Noise	$F = 1\text{ kHz}$		0.03				$\text{pA}/\sqrt{\text{Hz}}$	
T.H.D.	Total Harmonic Distortion	$F = 10\text{ kHz}$, $A_V = -2$ $R_L = 10\text{ k}\Omega$, $V_O = 4.1\text{ V}_{PP}$		0.01%					
		$F = 10\text{ kHz}$, $A_V = -2$ $R_L = 10\text{ k}\Omega$, $V_O = 8.5\text{ V}_{PP}$ $V^+ = 10\text{ V}$		0.01%					

(7) $V^+ = 15\text{ V}$. Connected as Voltage Follower with 10V step input. Number specified is the slower of either the positive or negative slew rates.

(8) Input referred, $V^+ = 15\text{ V}$ and $R_L = 100\text{ k}\Omega$ connected to 7.5 V. Each amp excited in turn with 1 kHz to produce $V_O = 12\text{ V}_{PP}$.

6.6 Electrical Characteristics for $V^+ = 3\text{ V}$

Unless otherwise specified, all limits specified for $T_J = 25^\circ\text{C}$, $V^+ = 3\text{ V}$, $V^- = 0\text{ V}$, $V_{CM} = V_O = V^+/2$ and $R_L > 1\text{ M}$.

PARAMETER	TEST CONDITIONS	$T_J = 25^\circ\text{C}$			At Temperature Extremes ⁽¹⁾			UNIT	
		MIN	TYP ⁽²⁾	MAX ⁽³⁾	MIN	TYP ⁽²⁾	MAX ⁽³⁾		
DC Electrical Characteristics									
V_{OS}	Input Offset Voltage		LMC6482AI	0.9	2	2.7			mV
			LMC6482I	0.9	3	3.7			
			LMC6482M	0.9	3	3.8			
TCV_{OS}	Input Offset Voltage Average Drift			2				$\mu\text{V}/^\circ\text{C}$	
I_B	Input Bias Current			0.02				pA	
I_{OS}	Input Offset Current			0.01				pA	
CMRR	Common Mode Rejection Ratio	$0\text{ V} \leq V_{CM} \leq 3\text{ V}$	LMC6482AI	64	74				dB
			LMC6482I	60	74				
			LMC6482M	60	74				

(1) See [Recommended Operating Conditions](#) for operating temperature ranges.

(2) Typical Values represent the most likely parametric norm.

(3) All limits are specified by testing or statistical analysis.

Electrical Characteristics for $V^+ = 3\text{ V}$ (continued)

 Unless otherwise specified, all limits specified for $T_J = 25^\circ\text{C}$, $V^+ = 3\text{ V}$, $V^- = 0\text{ V}$, $V_{CM} = V_O = V^+/2$ and $R_L > 1\text{ M}\Omega$.

PARAMETER	TEST CONDITIONS	$T_J = 25^\circ\text{C}$			At Temperature Extremes ⁽¹⁾			UNIT
		MIN	TYP ⁽²⁾	MAX ⁽³⁾	MIN	TYP ⁽²⁾	MAX ⁽³⁾	
PSRR Power Supply Rejection Ratio	$3\text{ V} \leq V^+ \leq 15\text{ V}$, $V^- = 0\text{ V}$	LMC6482AI	68	80				dB
		LMC6482I	60	80				
		LMC6482M	60	80				
V_{CM} Input Common-Mode Voltage Range	For CMRR ≥ 50 dB	LMC6482AI		$V^- - 0.25$	0			V
		LMC6482I		$V^- - 0.25$	0			
		LMC6482M		$V^- - 0.25$	0			
		LMC6482AI	V^+	$V^+ + 0.25$				V
		LMC6482I	V^+	$V^+ + 0.25$				
		LMC6482M	V^+	$V^+ + 0.25$				
V_O Output Swing	$R_L = 2\text{ k}\Omega$ to $V^+/2$			2.8			V	
				0.2			V	
	$R_L = 600\ \Omega$ to $V^+/2$	LMC6482AI	2.5	2.7				V
		LMC6482I	2.5	2.7				
		LMC6482M	2.5	2.7				
		LMC6482AI		0.37	0.6			V
		LMC6482I		0.37	0.6			
		LMC6482M		0.37	0.6			
I_S Supply Current	Both Amplifiers	LMC6482AI	0.825	1.2			1.5	mA
		LMC6482I	0.825	1.2			1.5	
		LMC6482M	0.825	1.2			1.6	
AC Electrical Characteristics								
SR	Slew Rate	See ⁽⁴⁾		0.9				V/ μs
GBW	Gain-Bandwidth Product			1				MHz
T.H.D.	Total Harmonic Distortion	$F = 10\text{ kHz}$, $A_V = -2$ $R_L = 10\text{ k}\Omega$, $V_O = 2\text{ V}_{PP}$		0.01%				

(4) Connected as voltage Follower with 2-V step input. Number specified is the slower of either the positive or negative slew rates.

6.7 Typical Characteristics

$V_S = 15\text{ V}$, Single Supply, $T_A = 25^\circ\text{C}$ unless otherwise specified

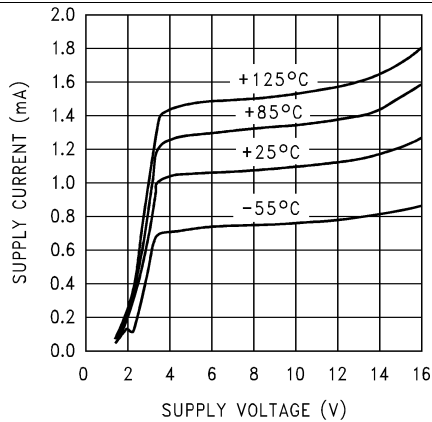

Figure 1. Supply Current vs. Supply Voltage

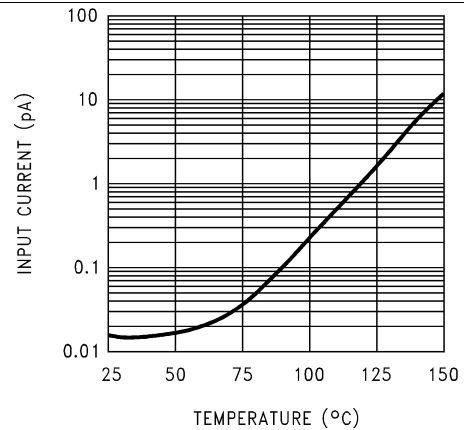

Figure 2. Input Current vs. Temperature

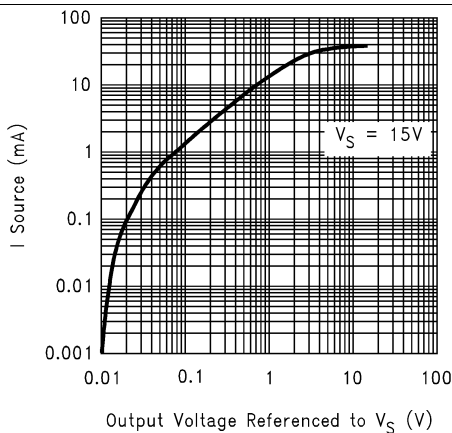

Figure 3. Sourcing Current vs. Output Voltage

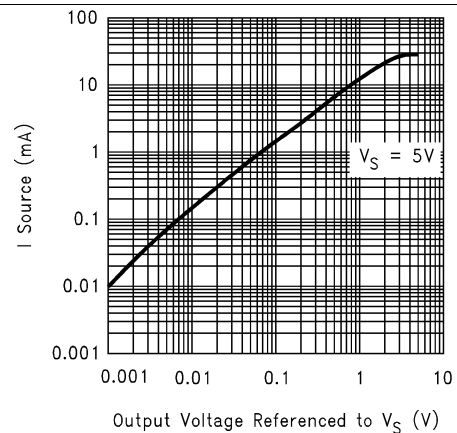

Figure 4. Sourcing Current vs. Output Voltage

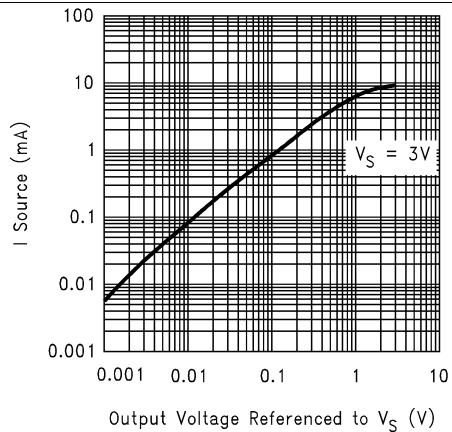

Figure 5. Sourcing Current vs. Output Voltage

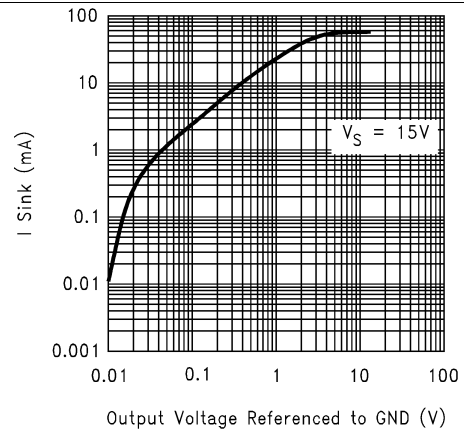

Figure 6. Sinking Current vs. Output Voltage

Typical Characteristics (continued)

$V_S = 15\text{ V}$, Single Supply, $T_A = 25^\circ\text{C}$ unless otherwise specified

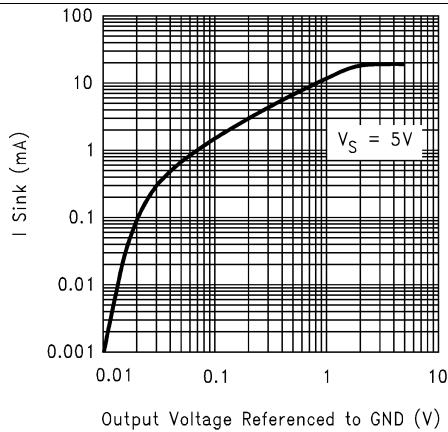

Figure 7. Sinking Current vs. Output Voltage

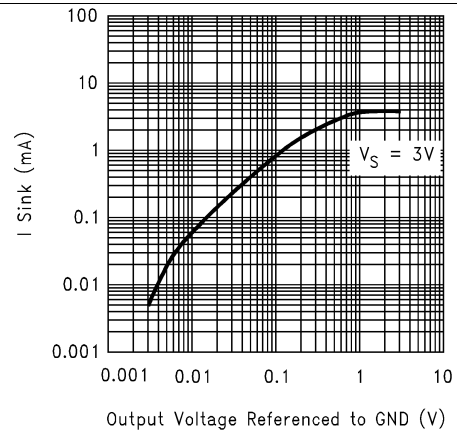

Figure 8. Sinking Current vs. Output Voltage

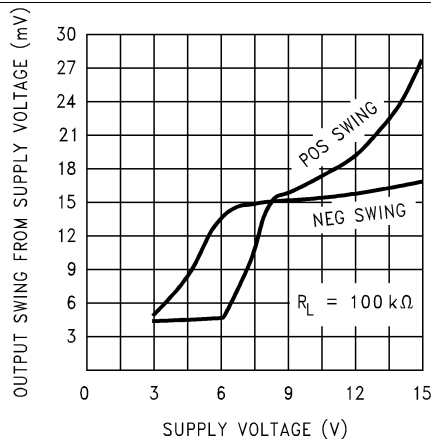

Figure 9. Output Voltage Swing vs. Supply Voltage

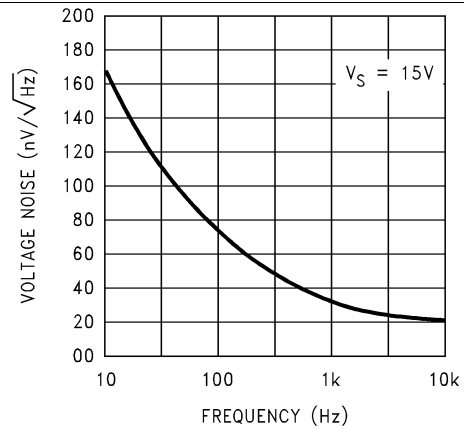

Figure 10. Input Voltage Noise vs. Frequency

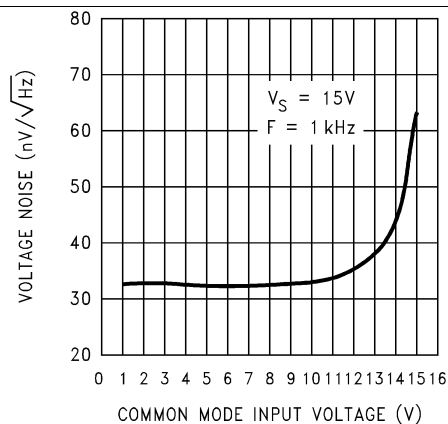

Figure 11. Input Voltage Noise vs. Input Voltage

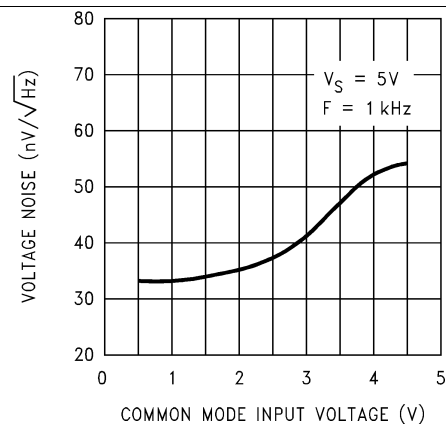

Figure 12. Input Voltage Noise vs. Input Voltage

Typical Characteristics (continued)

$V_S = 15\text{ V}$, Single Supply, $T_A = 25^\circ\text{C}$ unless otherwise specified

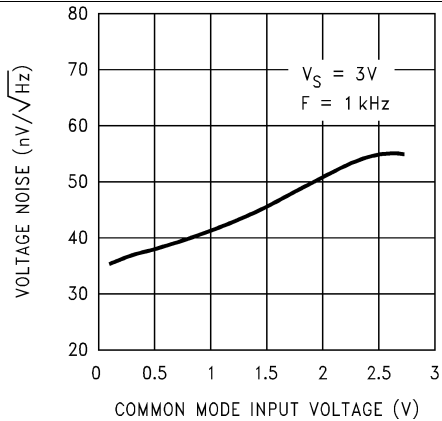

Figure 13. Input Voltage Noise vs. Input Voltage

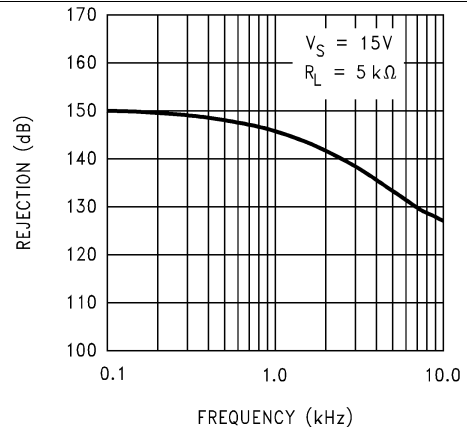

Figure 14. Crosstalk Rejection vs. Frequency

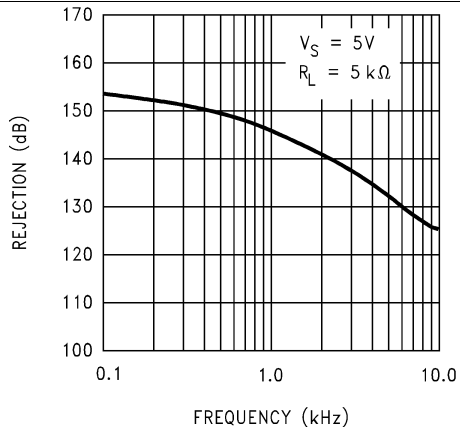

Figure 15. Crosstalk Rejection vs. Frequency

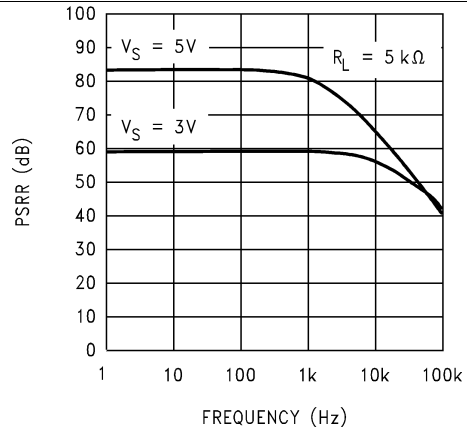

Figure 16. Positive PSRR vs. Frequency

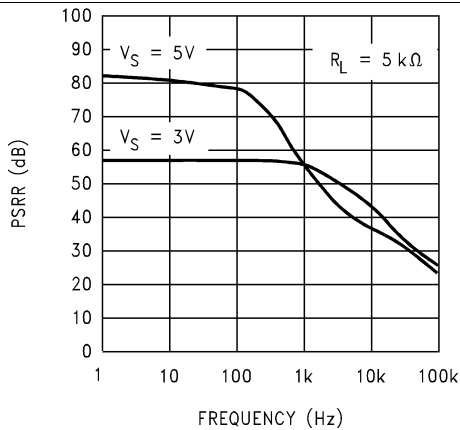

Figure 17. Negative PSRR vs. Frequency

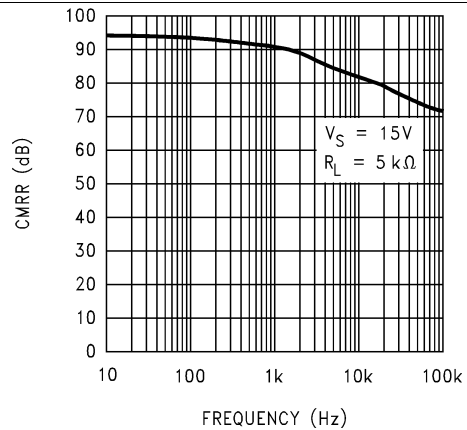
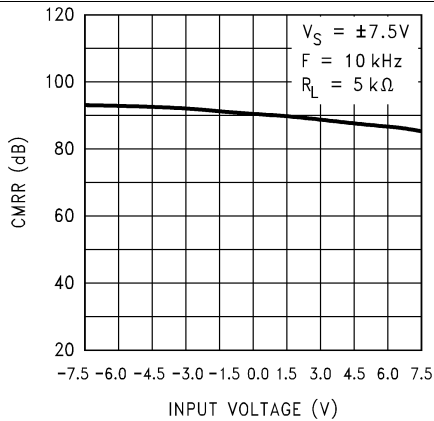
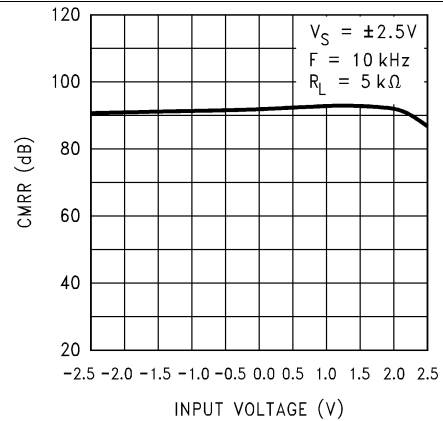
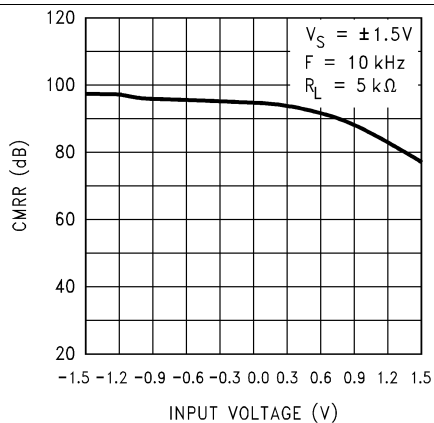
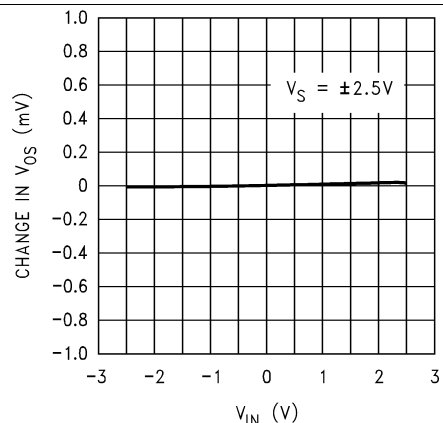
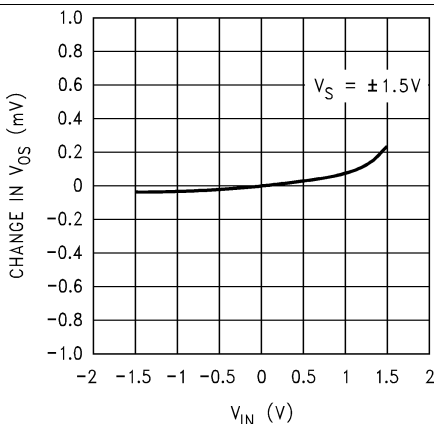
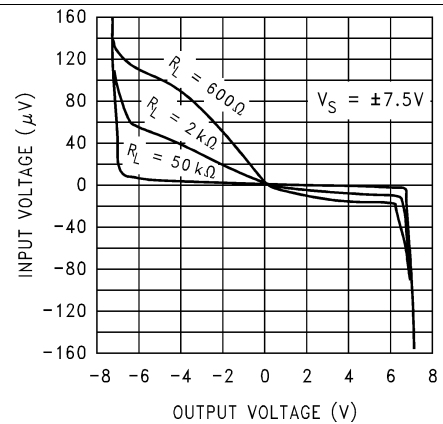

Figure 18. CMRR vs. Frequency

Typical Characteristics (continued)
 $V_S = 15\text{ V}$, Single Supply, $T_A = 25^\circ\text{C}$ unless otherwise specified

Figure 19. CMRR vs. Input Voltage

Figure 20. CMRR vs. Input Voltage

Figure 21. CMRR vs. Input Voltage

Figure 22. ΔV_{OS} vs. CMR

Figure 23. ΔV_{OS} vs. CMR

Figure 24. Input Voltage vs. Output Voltage

Typical Characteristics (continued)

$V_S = 15\text{ V}$, Single Supply, $T_A = 25^\circ\text{C}$ unless otherwise specified

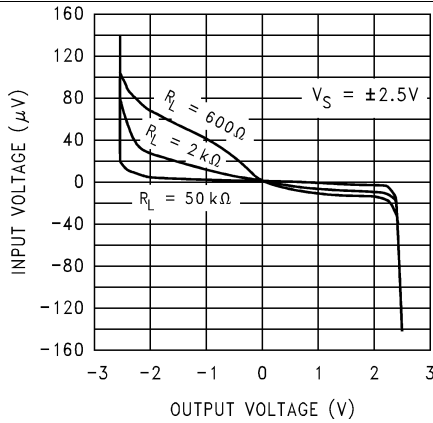

Figure 25. Input Voltage vs. Output Voltage

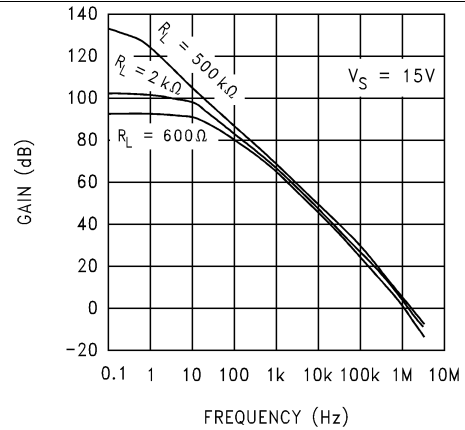

Figure 26. Open-Loop Frequency Response

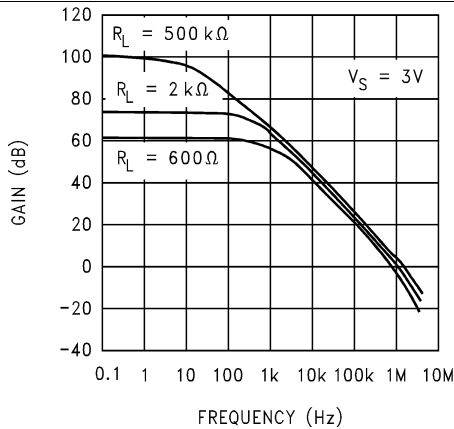

Figure 27. Open-Loop Frequency Response

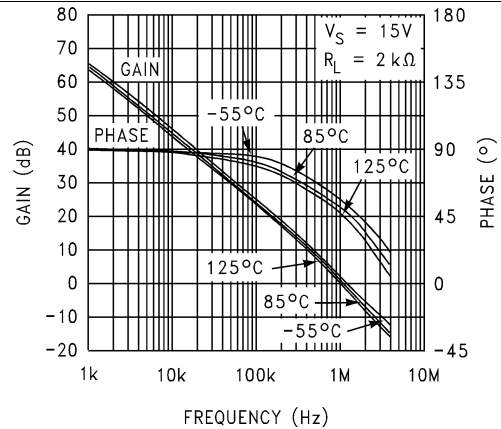

Figure 28. Open-Loop Frequency Response vs. Temperature

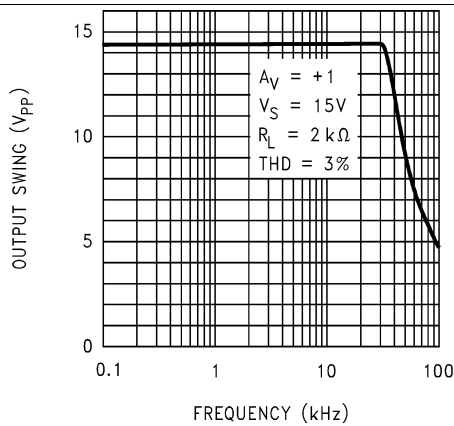

Figure 29. Maximum Output Swing vs. Frequency

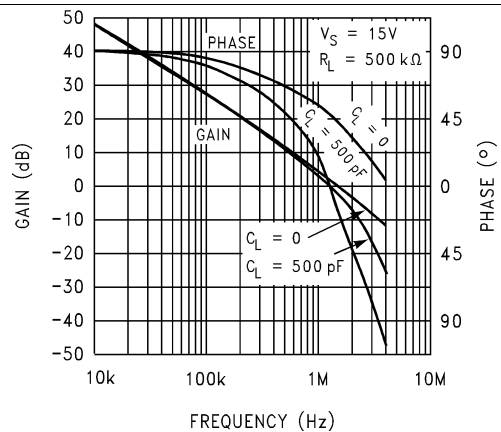

Figure 30. Gain and Phase vs. Capacitive Load

Typical Characteristics (continued)

$V_S = 15\text{ V}$, Single Supply, $T_A = 25^\circ\text{C}$ unless otherwise specified

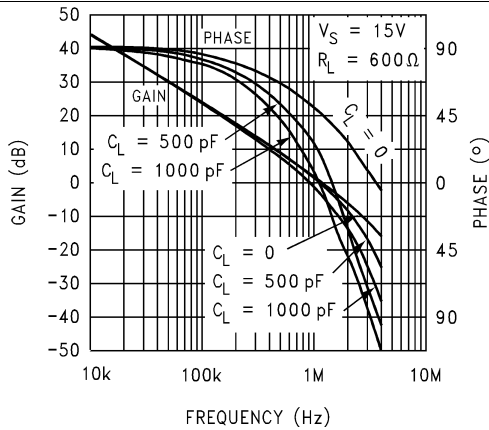

Figure 31. Gain and Phase vs. Capacitive Load

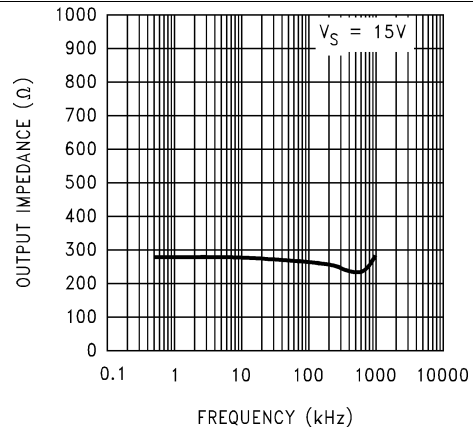

Figure 32. Open-Loop Output Impedance vs. Frequency

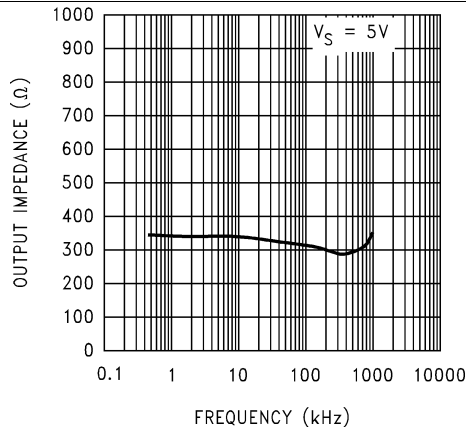

Figure 33. Open-Loop Output Impedance vs. Frequency

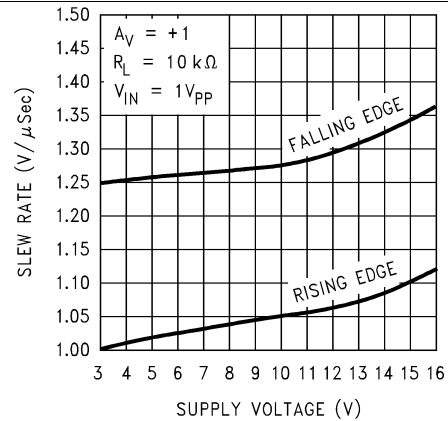

Figure 34. Slew Rate vs. Supply Voltage

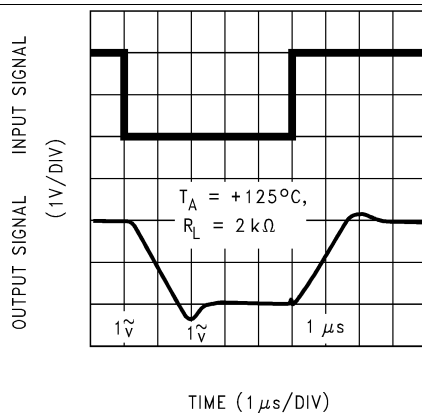

Figure 35. Noninverting Large Signal Pulse Response

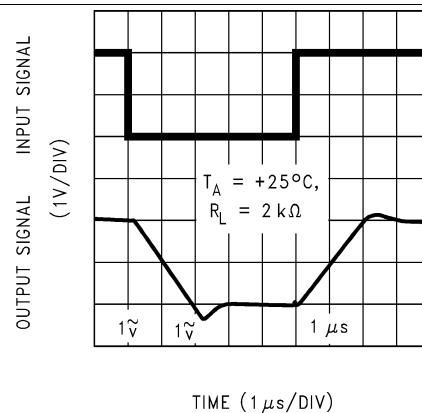

Figure 36. Noninverting Large Signal Pulse Response

Typical Characteristics (continued)

$V_S = 15\text{ V}$, Single Supply, $T_A = 25^\circ\text{C}$ unless otherwise specified

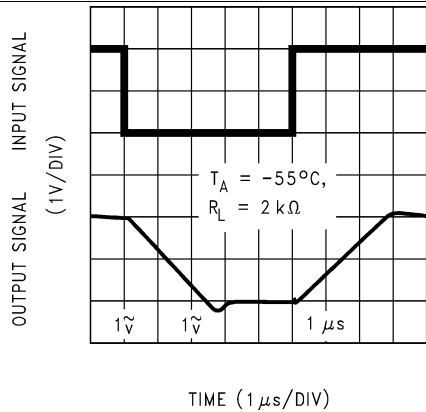

Figure 37. Noninverting Large Signal Pulse Response

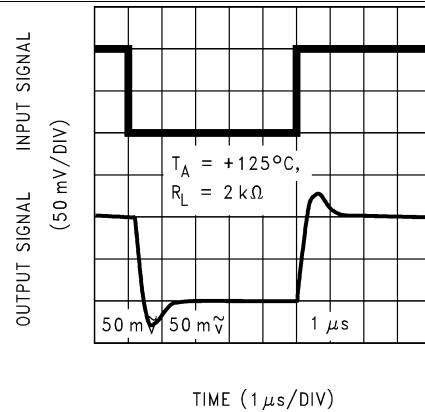

Figure 38. Noninverting Small Signal Pulse Response

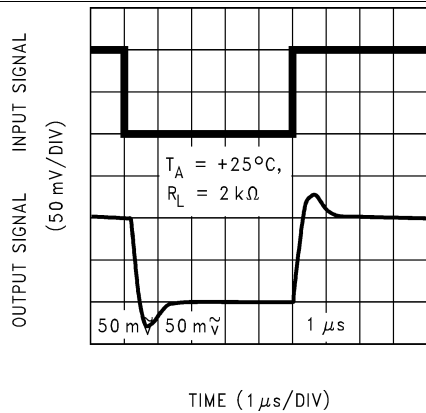

Figure 39. Noninverting Small Signal Pulse Response

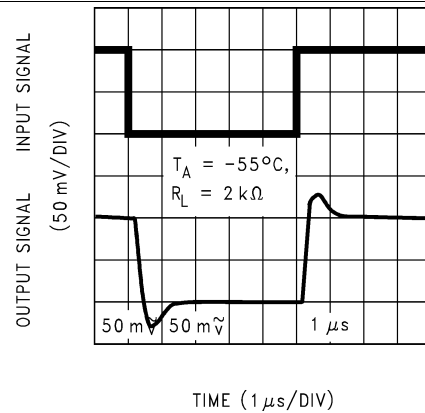

Figure 40. Noninverting Small Signal Pulse Response

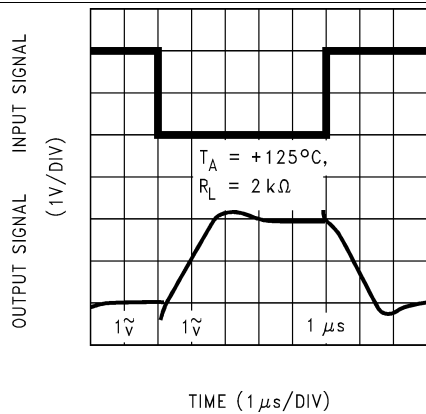

Figure 41. Inverting Large Signal Pulse Response

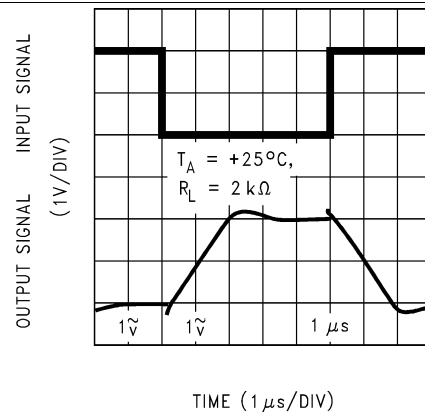

Figure 42. Inverting Large Signal Pulse Response

Typical Characteristics (continued)

$V_S = 15\text{ V}$, Single Supply, $T_A = 25^\circ\text{C}$ unless otherwise specified

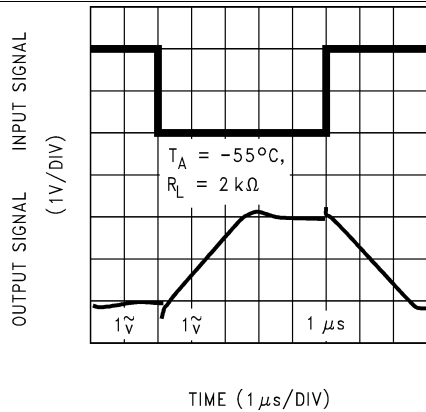

Figure 43. Inverting Large Signal Pulse Response

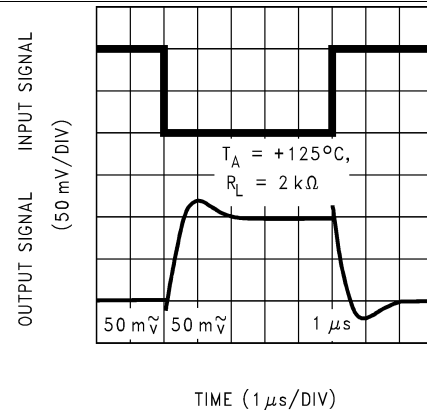

Figure 44. Inverting Small Signal Pulse Response

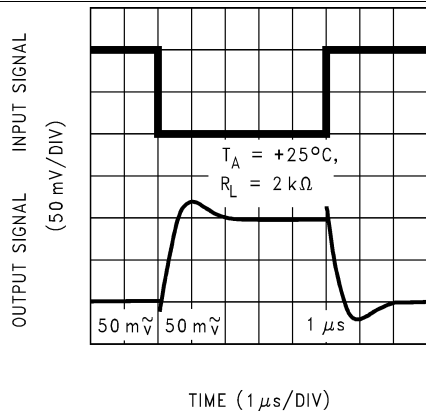

Figure 45. Inverting Small Signal Pulse Response

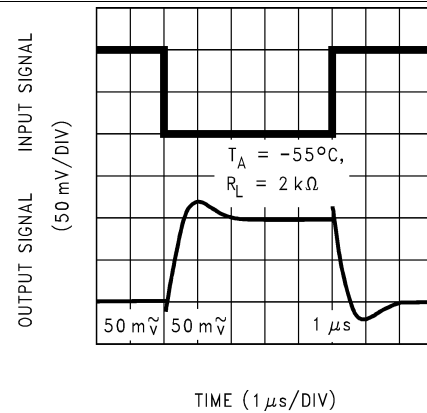

Figure 46. Inverting Small Signal Pulse Response

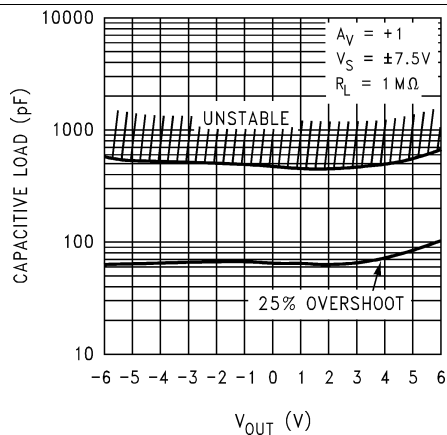

Figure 47. Stability vs. Capacitive Load

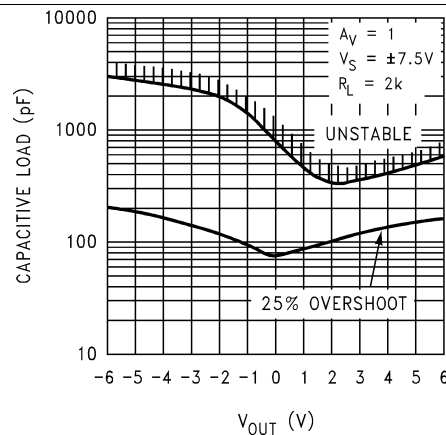

Figure 48. Stability vs. Capacitive Load

Typical Characteristics (continued)

$V_S = 15\text{ V}$, Single Supply, $T_A = 25^\circ\text{C}$ unless otherwise specified

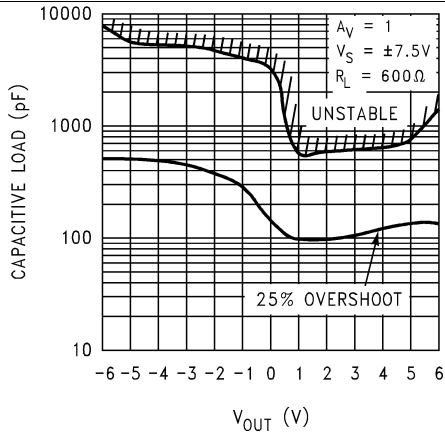

Figure 49. Stability vs. Capacitive Load

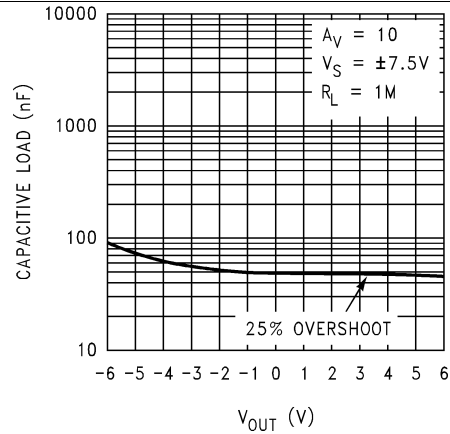

Figure 50. Stability vs. Capacitive Load

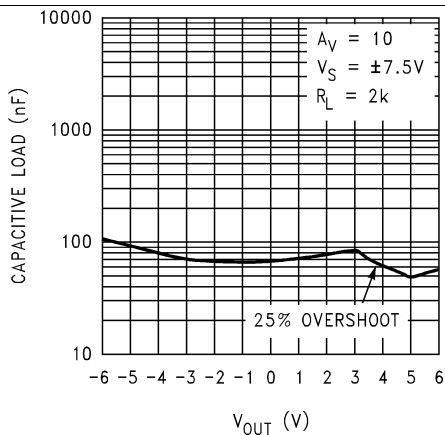

Figure 51. Stability vs. Capacitive Load

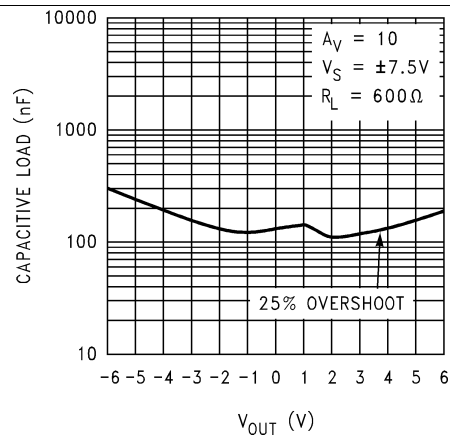

Figure 52. Stability vs. Capacitive Load

7 Detailed Description

7.1 Overview

The LMC6482 is a dual CMOS operational amplifier that supports both rail-to-rail inputs and outputs. It may be operated in both dual supply mode and single supply mode.

7.2 Functional Block Diagram

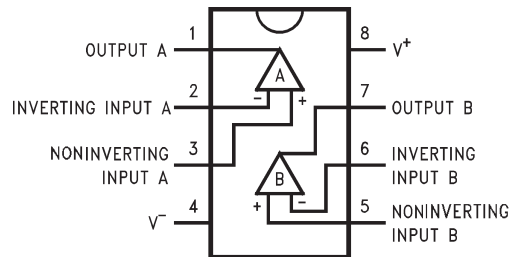

7.3 Feature Description

7.3.1 Amplifier Topology

The LMC6482 incorporates specially designed wide-compliance range current mirrors and the body effect to extend input common-mode range to each supply rail. Complementary paralleled differential input stages, like the type used in other CMOS and bipolar rail-to-rail input amplifiers, were not used because of their inherent accuracy problems due to CMRR, crossover distortion, and open-loop gain variation.

The LMC6482s input stage design is complemented by an output stage capable of rail-to-rail output swing even when driving a large load. Rail-to-rail output swing is obtained by taking the output directly from the internal integrator instead of an output buffer stage.

7.3.2 Input Common-Mode Voltage Range

Unlike Bi-FET amplifier designs, the LMC6482 does not exhibit phase inversion when an input voltage exceeds the negative supply voltage. [Figure 53](#) shows an input voltage exceeding both supplies with no resulting phase inversion on the output.

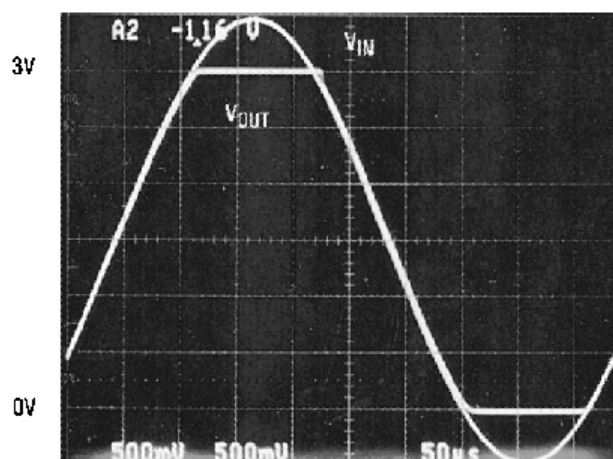

An input voltage signal exceeds the LMC6482 power supply voltages with no output phase inversion.

Figure 53. Input Voltage

The absolute maximum input voltage is 300 mV beyond either supply rail at room temperature. Voltages greatly exceeding this absolute maximum rating, as in [Figure 54](#), can cause excessive current to flow in or out of the input pins possibly affecting reliability.

Feature Description (continued)

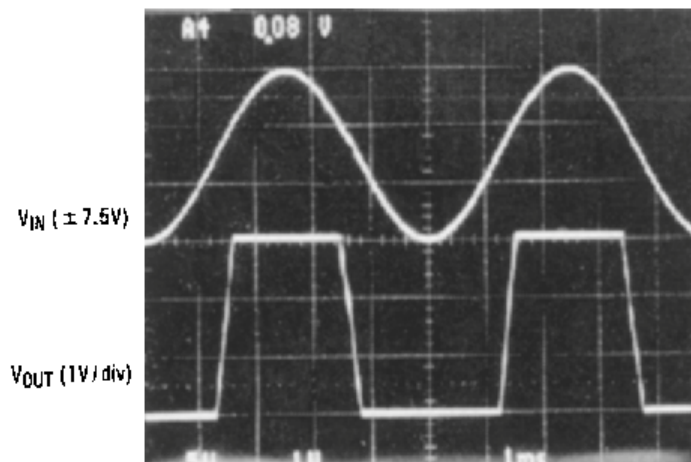

A $\pm 7.5\text{-V}$ input signal greatly exceeds the 3-V supply in [Figure 55](#) causing no phase inversion due to R_I .

Figure 54. Input Signal

Applications that exceed this rating must externally limit the maximum input current to $\pm 5\text{ mA}$ with an input resistor (R_I) as shown in [Figure 55](#).

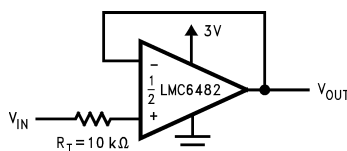

R_I input current protection for voltages exceeding the supply voltages.

Figure 55. R_I Input Current Protection for Voltages Exceeding the Supply Voltages

7.3.3 Rail-to-Rail Output

The approximated output resistance of the LMC6482 is 180- Ω sourcing and 13-0 Ω sinking at $V_S = 3\text{ V}$ and 110- Ω sourcing and 80- Ω sinking at $V_S = 5\text{ V}$. Using the calculated output resistance, maximum output voltage swing can be estimated as a function of load.

7.4 Device Functional Modes

The LMC6482 may be used in applications where each amplifier channel is used independently, or in applications in which the channels are cascaded. See [Typical Applications](#) for more information.

8 Application and Implementation

NOTE

Information in the following applications sections is not part of the TI component specification, and TI does not warrant its accuracy or completeness. TI's customers are responsible for determining suitability of components for their purposes. Customers should validate and test their design implementation to confirm system functionality.

8.1 Application Information

8.1.1 Upgrading Applications

The LMC6484 quads and LMC6482 duals have industry-standard pin outs to retrofit existing applications. System performance can be greatly increased by the features of the LMC6482. The key benefit of designing in the LMC6482 is increased linear signal range. Most op-amps have limited input common-mode ranges. Signals that exceed this range generate a nonlinear output response that persists long after the input signal returns to the common-mode range.

Linear signal range is vital in applications such as filters where signal peaking can exceed input common-mode ranges resulting in output phase inversion or severe distortion.

8.1.2 Data Acquisition Systems

Low power, single supply data acquisition system solutions are provided by buffering the ADC12038 with the LMC6482 (Figure 56). Capable of using the full supply range, the LMC6482 does not require input signals to be scaled down to meet limited common-mode voltage ranges. The LMC4282 CMRR of 82 dB maintains integral linearity of a 12-bit data acquisition system to ± 0.325 LSB. Other rail-to-rail input amplifiers with only 50 dB of CMRR will degrade the accuracy of the data acquisition system to only 8 bits.

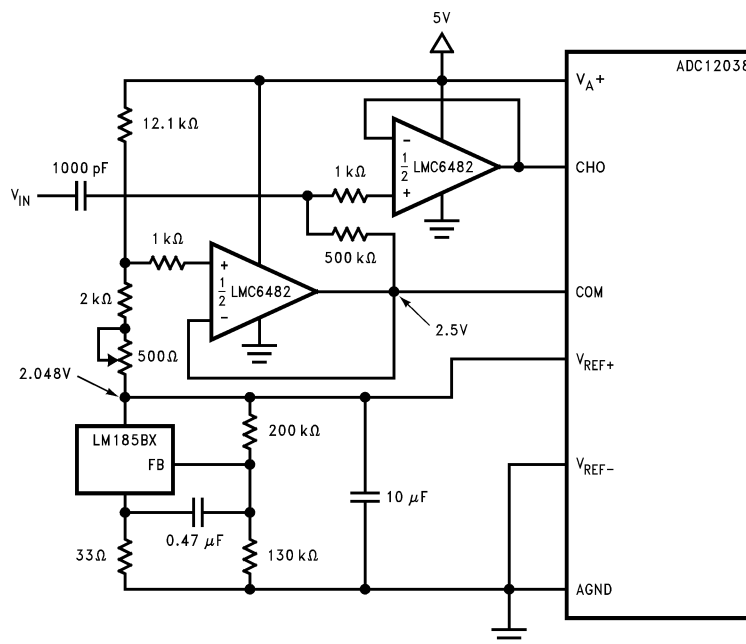

Operating from the same supply voltage, the LMC6482 buffers the ADC12038 maintaining excellent accuracy.

Figure 56. Buffering the ADC12038 With the LMC6482

Application Information (continued)

8.1.3 Instrumentation Circuits

The LMC6482 has the high input impedance, large common-mode range and high CMRR needed for designing instrumentation circuits. Instrumentation circuits designed with the LMC6482 can reject a larger range of common-mode signals than most in-amps. This makes instrumentation circuits designed with the LMC6482 an excellent choice of noisy or industrial environments. Other applications that benefit from these features include analytic medical instruments, magnetic field detectors, gas detectors, and silicon-based transducers.

A small valued potentiometer is used in series with R_G to set the differential gain of the 3-op-amp instrumentation circuit in Figure 57. This combination is used instead of one large valued potentiometer to increase gain trim accuracy and reduce error due to vibration.

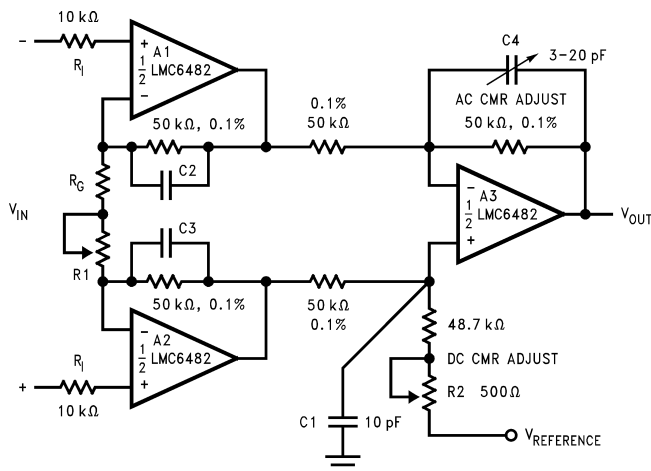

Figure 57. Low Power 3-Op-Amp Instrumentation Amplifier

A 2-op-amp instrumentation amplifier designed for a gain of 100 is shown in Figure 58. Low sensitivity trimming is made for offset voltage, CMRR, and gain. Low cost and low power consumption are the main advantages of this 2-op-amp circuit.

Higher frequency and larger common-mode range applications are best facilitated by a 3-op-amp instrumentation amplifier.

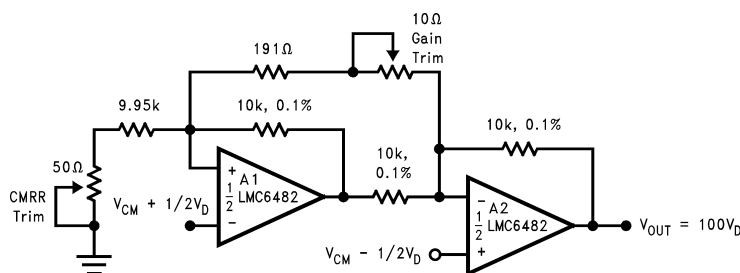

Figure 58. Low-Power Two-Op-Amp Instrumentation Amplifier

8.1.4 Spice Macromodel

A spice macromodel is available for the LMC6482. This model includes accurate simulation of the following:

- Input common-mode voltage range
- Frequency and transient response
- GBW dependence on loading conditions
- Quiescent and dynamic supply current
- Output swing dependence on loading conditions

Many more characteristics are listed on the macromodel disk.

Application Information (continued)

Contact your local TI sales office to obtain an operational amplifier spice model library disk.

8.2 Typical Applications

8.2.1 3-V Single Supply Buffer Circuit

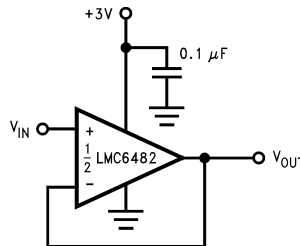

Figure 59. 3-V Single Supply Buffer Circuit

8.2.1.1 Design Requirements

For best performance, ensure that the input voltage swing is between V_+ and V_- .

Ensure that the input does not exceed the common-mode input range.

To reduce the risk of destabilizing the output, use resistive isolation on the output when driving capacitive loads (see the [Detailed Design Procedure](#) section).

When large feedback resistors are used, it may be necessary to compensate for parasitic capacitance on the input. See the [Detailed Design Procedure](#) section.

8.2.1.2 Detailed Design Procedure

8.2.1.2.1 Capacitive Load Compensation

Capacitive load compensation can be accomplished using resistive isolation as shown in [Figure 60](#). This simple technique is useful for isolating the capacitive inputs of multiplexers and A/D converters.

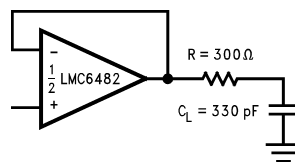

Figure 60. Resistive Isolation of a 330-pF Capacitive Load

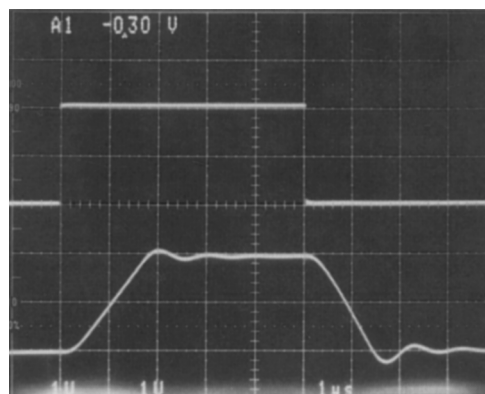

Figure 61. Pulse Response of the LMC6482 Circuit in [Figure 60](#)

Typical Applications (continued)

8.2.1.2.1.1 Capacitive Load Tolerance

The LMC6482 can typically directly drive a 100-pF load with $V_S = 15\text{ V}$ at unity gain without oscillating. The unity gain follower is the most sensitive configuration. Direct capacitive loading reduces the phase margin of op-amps. The combination of the output impedance of the op-amp and the capacitive load induces phase lag. This results in either an underdamped pulse response or oscillation.

Improved frequency response is achieved by indirectly driving capacitive loads, as shown in [Figure 62](#).

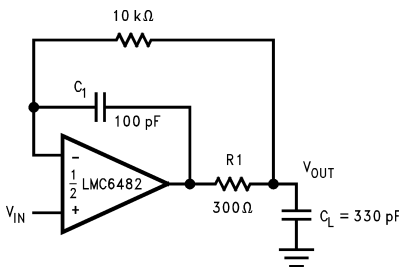

Compensated to handle a 330pF capacitive load.

Figure 62. LMC6482 Noninverting Amplifier

R1 and C1 serve to counteract the loss of phase margin by feeding forward the high-frequency component of the output signal back to the amplifiers inverting input, thereby preserving phase margin in the overall feedback loop. The values of R1 and C1 are experimentally determined for the desired pulse response. The resulting pulse response is shown in [Figure 63](#).

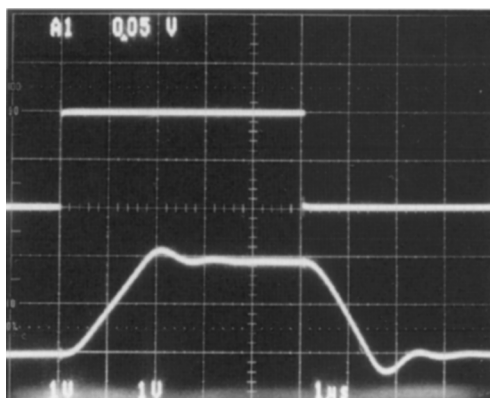

Figure 63. Pulse Response of Lmc6482 Circuit in [Figure 62](#)

8.2.1.2.1.2 Compensating For Input Capacitance

It is quite common to use large values of feedback resistance with amplifiers that have ultralow input current, like the LMC6482. Large feedback resistors can react with small values of input capacitance due to transducers, photo diodes, and circuits board parasitics to reduce phase margins.

Typical Applications (continued)

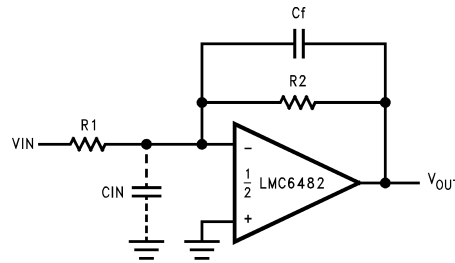

Figure 64. Canceling the Effect of Input Capacitance

The effect of input capacitance can be compensated for by adding a feedback capacitor. The feedback capacitor (as in Figure 64), C_f , is first estimated by:

$$\frac{1}{2\pi R_1 C_{IN}} \geq \frac{1}{2\pi R_2 C_f} \tag{1}$$

or

$$R_1 C_{IN} \leq R_2 C_f \tag{2}$$

which typically provides significant overcompensation.

Printed-circuit-board stray capacitance may be larger or smaller than that of a bread-board, so the actual optimum value for C_f may be different. The values of C_f should be checked on the actual circuit. (Refer to the LMC660 quad CMOS amplifier data sheet for a more detailed discussion.)

8.2.1.2.1.3 Offset Voltage Adjustment

Offset voltage adjustment circuits are illustrated in Figure 65 and Figure 66. Large value resistances and potentiometers are used to reduce power consumption while providing typically ± 2.5 mV of adjustment range, referred to the input, for both configurations with $V_S = \pm 5$ V.

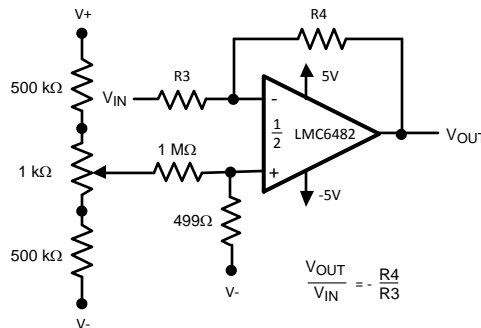

Figure 65. Inverting Configuration Offset Voltage Adjustment

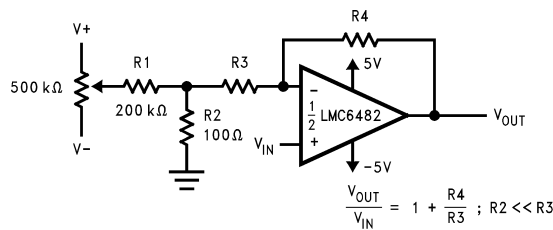
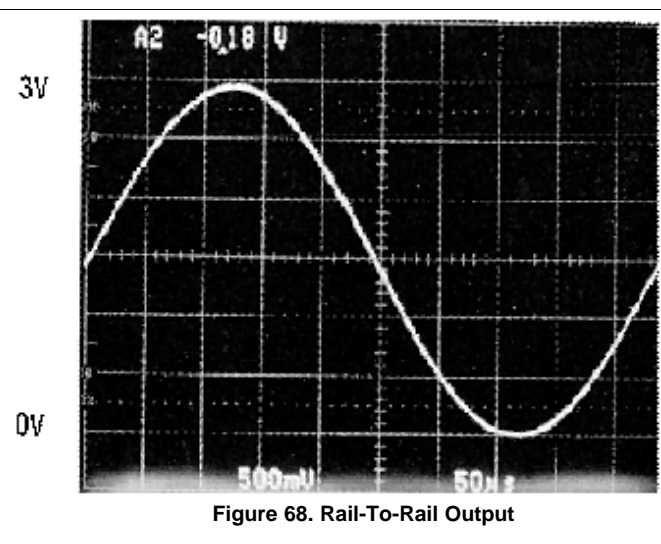
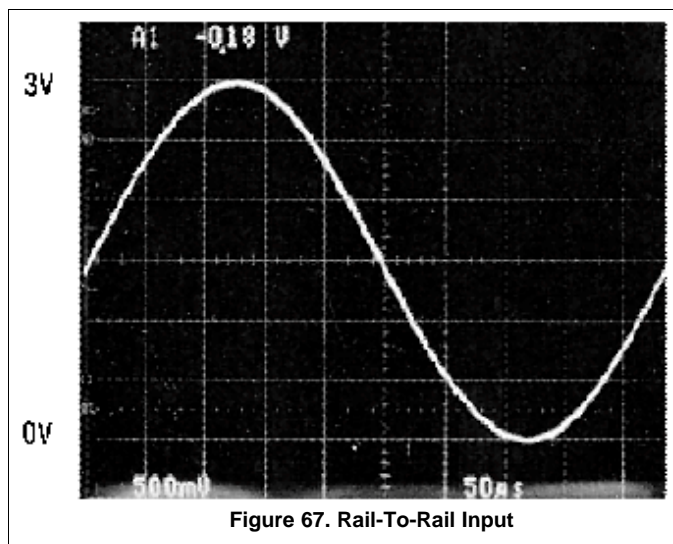

Figure 66. Noninverting Configuration Offset Voltage Adjustment

Typical Applications (continued)

8.2.1.3 Application Curves



8.2.2 Typical Single-Supply Applications

The circuit in [Figure 69](#) uses a single supply to half-wave rectify a sinusoid centered about ground. R_1 limits current into the amplifier caused by the input voltage exceeding the supply voltage. Full-wave rectification is provided by the circuit in [Figure 71](#).

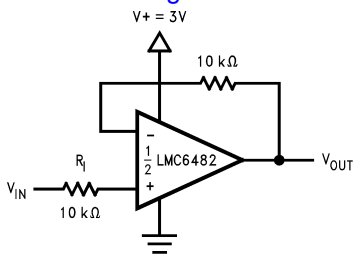
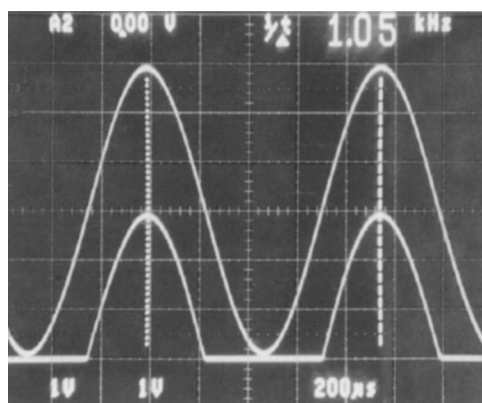
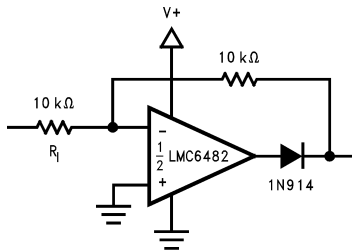
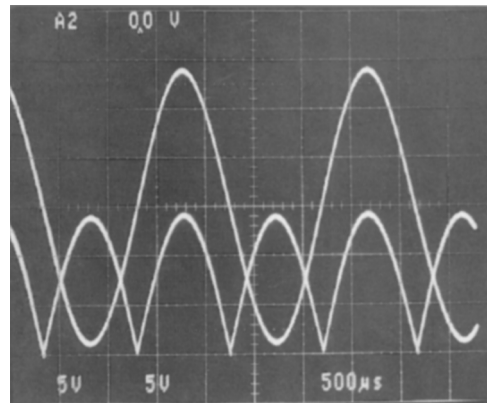
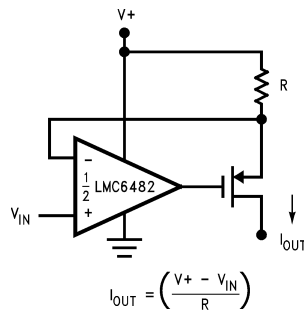
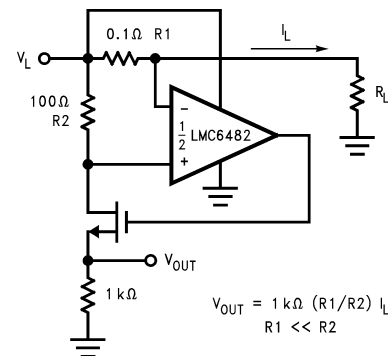
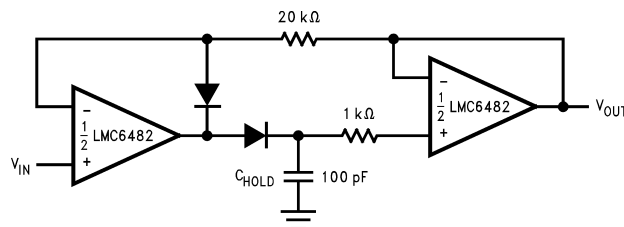

Figure 69. Half-Wave Rectifier With Input Current Protection (R_1)



Typical Applications (continued)

In [Figure 75](#) dielectric absorption and leakage is minimized by using a polystyrene or polyethylene hold capacitor. The droop rate is primarily determined by the value of C_H and diode leakage current. The ultralow input current of the LMC6482 has a negligible effect on droop.

Figure 71. Full-Wave Rectifier With Input Current Protection (R_1)

Figure 72. Full-Wave Rectifier Waveform

Figure 73. Large Compliance Range Current Source

Figure 74. Positive Supply Current Sense

Figure 75. Low-Voltage Peak Detector With Rail-To-Rail Peak Capture Range

Typical Applications (continued)

The high CMRR (82 dB) of the LMC6482 allows excellent accuracy throughout the rail-to-rail dynamic capture range of the circuit.

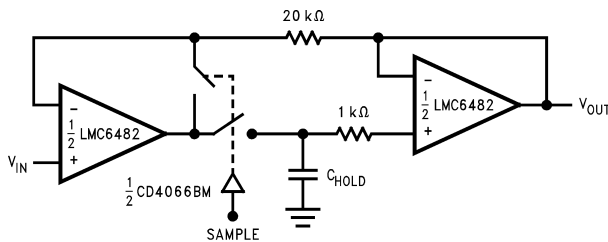
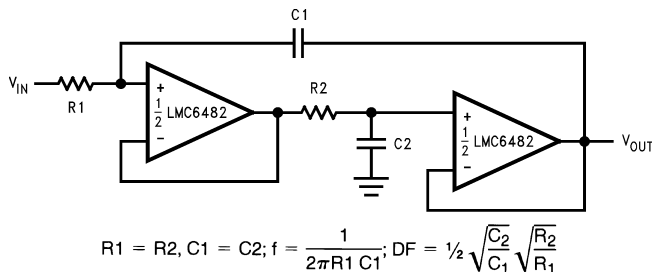

Figure 76. Rail-To-Rail Sample and Hold

The low-pass filter circuit in Figure 77 can be used as an anti-aliasing filter with the same voltage supply as the A/D converter.

Filter designs can also take advantage of the LMC6482 ultralow input current. The ultralow input current yields negligible offset error even when large value resistors are used. This in turn allows the use of smaller valued capacitors which take less board space and cost less.



$$R1 = R2, C1 = C2; f = \frac{1}{2\pi R1 C1}; DF = \frac{1}{2} \sqrt{\frac{C2}{C1}} \sqrt{\frac{R2}{R1}}$$

Figure 77. Rail-To-Rail Single Supply Low Pass Filter

9 Power Supply Recommendations

The LMC6482 can be operated over a supply range of 3 V to 15 V. To achieve noise immunity as appropriate to the application, it is important to use good PCB layout practices for power supply rails and planes, as well as using bypass capacitors connected between the power supply pins and ground.

10 Layout

10.1 Layout Guidelines

It is generally recognized that any circuit which must operate with less than 1000 pA of leakage current requires special layout of the PC board. When one wishes to take advantage of the ultralow input current of the LMC6482, typically less than 20 fA, it is essential to have an excellent layout. Fortunately, the techniques of obtaining low leakages are quite simple. First, the user must not ignore the surface leakage of the PCB, even through it may sometimes appear acceptably low, because under conditions of high humidity or dust or contamination, the surface leakage will be appreciable.

To minimize the effect of any surface leakage, lay out a ring of foil completely surrounding the LM6482s inputs and the terminals of capacitors, diodes, conductors, resistors, relay terminals, and so forth connected to the inputs of the op-amp, as in [Figure 78](#). To have a significant effect, guard rings should be placed on both the top and bottom of the PCB. This PC foil must then be connected to a voltage which is at the same voltage as the amplifier inputs, because no leakage current can flow between two points at the same potential. For example, a PCB trace-to-pad resistance of $10^{12} \Omega$, which is normally considered a very large resistance, could leak 5 pA if the trace were a 5-V bus adjacent to the pad of the input. This would cause a 250 times degradation from the actual performance of the LMC6482. However, if a guard ring is held within 5 mV of the inputs, then even a resistance of $10^{11} \Omega$ would cause only 0.05 pA of leakage current. See [Figure 79](#) through [Figure 81](#) for typical connections of guard rings for standard op-amp configurations.

The designer should be aware that when it is inappropriate to lay out a PCB for the sake of just a few circuits, another technique is even better than a guard ring on a PCB: Do not insert the input pin of the amplifier into the PCB at all, but bend it up in the air and use only air as an insulator. Air is an excellent insulator. In this case you may have to forego some of the advantages of PCB construction, but the advantages are sometimes well worth the effort of using point-to-point up-in-the-air wiring. See [Figure 82](#).

10.2 Layout Example

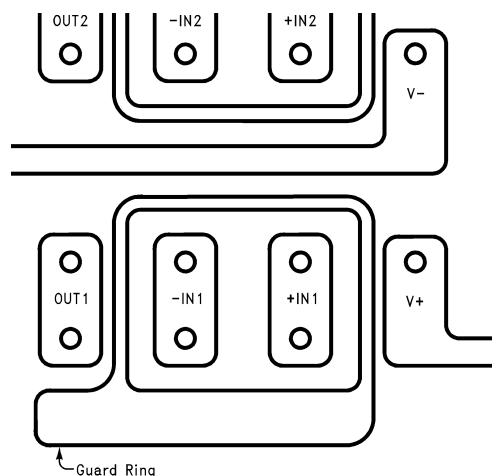

Figure 78. Example of Guard Ring in PCB Layout Typical Connections of Guard Rings

Layout Example (continued)

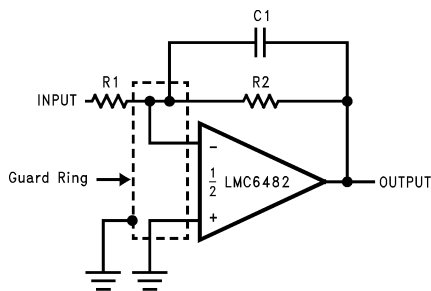

Figure 79. Inverting Amplifier Typical Connections of Guard Rings

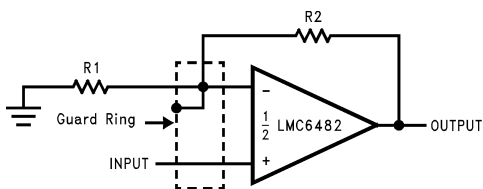

Figure 80. Noninverting Amplifier Typical Connections of Guard Rings

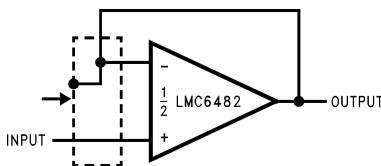
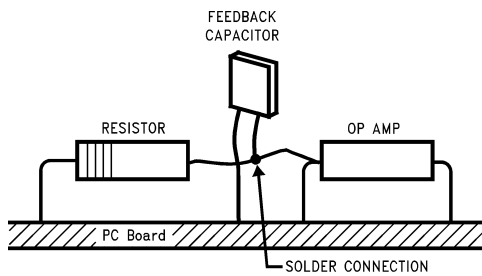

Figure 81. Follower Typical Connections of Guard Rings



(Input pins are lifted out of PCB and soldered directly to components. All other pins connected to PCB.)

Figure 82. Air Wiring

11 Device and Documentation Support

11.1 Trademarks

All trademarks are the property of their respective owners.

11.2 Electrostatic Discharge Caution



These devices have limited built-in ESD protection. The leads should be shorted together or the device placed in conductive foam during storage or handling to prevent electrostatic damage to the MOS gates.

11.3 Glossary

[SLYZ022](#) — *TI Glossary*.

This glossary lists and explains terms, acronyms, and definitions.

12 Mechanical, Packaging, and Orderable Information

The following pages include mechanical, packaging, and orderable information. This information is the most current data available for the designated devices. This data is subject to change without notice and revision of this document. For browser-based versions of this data sheet, refer to the left-hand navigation.

PACKAGING INFORMATION

Orderable Device	Status (1)	Package Type	Package Drawing	Pins	Package Qty	Eco Plan (2)	Lead/Ball Finish (6)	MSL Peak Temp (3)	Op Temp (°C)	Device Marking (4/5)	Samples
LMC6482AIM	NRND	SOIC	D	8	95	TBD	Call TI	Call TI	-40 to 85	LMC6482AIM	
LMC6482AIM/NOPB	ACTIVE	SOIC	D	8	95	Green (RoHS & no Sb/Br)	CU SN	Level-1-260C-UNLIM	-40 to 85	LMC6482AIM	Samples
LMC6482AIMX	NRND	SOIC	D	8	2500	TBD	Call TI	Call TI	-40 to 85	LMC6482AIM	
LMC6482AIMX/NOPB	ACTIVE	SOIC	D	8	2500	Green (RoHS & no Sb/Br)	CU SN	Level-1-260C-UNLIM	-40 to 85	LMC6482AIM	Samples
LMC6482AIN/NOPB	ACTIVE	PDIP	P	8	40	Green (RoHS & no Sb/Br)	CU SN	Level-1-NA-UNLIM	-40 to 85	LMC6482AIN	Samples
LMC6482IM	NRND	SOIC	D	8	95	TBD	Call TI	Call TI	-40 to 85	LMC6482IM	
LMC6482IM/NOPB	ACTIVE	SOIC	D	8	95	Green (RoHS & no Sb/Br)	CU SN	Level-1-260C-UNLIM	-40 to 85	LMC6482IM	Samples
LMC6482IMM	NRND	VSSOP	DGK	8	1000	TBD	Call TI	Call TI	-40 to 85	A10	
LMC6482IMM/NOPB	ACTIVE	VSSOP	DGK	8	1000	Green (RoHS & no Sb/Br)	CU SN	Level-1-260C-UNLIM	-40 to 85	A10	Samples
LMC6482IMMX	NRND	VSSOP	DGK	8	3500	TBD	Call TI	Call TI	-40 to 85	A10	
LMC6482IMMX/NOPB	ACTIVE	VSSOP	DGK	8	3500	Green (RoHS & no Sb/Br)	CU SN	Level-1-260C-UNLIM	-40 to 85	A10	Samples
LMC6482IMX	NRND	SOIC	D	8	2500	TBD	Call TI	Call TI	-40 to 85	LMC6482IMX	
LMC6482IMX/NOPB	ACTIVE	SOIC	D	8	2500	Green (RoHS & no Sb/Br)	CU SN	Level-1-260C-UNLIM	-40 to 85	LMC6482IMX	Samples
LMC6482IN/NOPB	ACTIVE	PDIP	P	8	40	Green (RoHS & no Sb/Br)	CU SN	Level-1-NA-UNLIM	-40 to 85	LMC6482IN	Samples

(1) The marketing status values are defined as follows:

ACTIVE: Product device recommended for new designs.

LIFEBUY: TI has announced that the device will be discontinued, and a lifetime-buy period is in effect.

NRND: Not recommended for new designs. Device is in production to support existing customers, but TI does not recommend using this part in a new design.

PREVIEW: Device has been announced but is not in production. Samples may or may not be available.

OBSELETE: TI has discontinued the production of the device.

(2) **RoHS:** TI defines "RoHS" to mean semiconductor products that are compliant with the current EU RoHS requirements for all 10 RoHS substances, including the requirement that RoHS substance do not exceed 0.1% by weight in homogeneous materials. Where designed to be soldered at high temperatures, "RoHS" products are suitable for use in specified lead-free processes. TI may reference these types of products as "Pb-Free".

RoHS Exempt: TI defines "RoHS Exempt" to mean products that contain lead but are compliant with EU RoHS pursuant to a specific EU RoHS exemption.

Green: TI defines "Green" to mean the content of Chlorine (Cl) and Bromine (Br) based flame retardants meet JS709B low halogen requirements of ≤ 1000 ppm threshold. Antimony trioxide based flame retardants must also meet the ≤ 1000 ppm threshold requirement.

(3) MSL, Peak Temp. - The Moisture Sensitivity Level rating according to the JEDEC industry standard classifications, and peak solder temperature.

(4) There may be additional marking, which relates to the logo, the lot trace code information, or the environmental category on the device.

(5) Multiple Device Markings will be inside parentheses. Only one Device Marking contained in parentheses and separated by a "~" will appear on a device. If a line is indented then it is a continuation of the previous line and the two combined represent the entire Device Marking for that device.

(6) Lead/Ball Finish - Orderable Devices may have multiple material finish options. Finish options are separated by a vertical ruled line. Lead/Ball Finish values may wrap to two lines if the finish value exceeds the maximum column width.

Important Information and Disclaimer: The information provided on this page represents TI's knowledge and belief as of the date that it is provided. TI bases its knowledge and belief on information provided by third parties, and makes no representation or warranty as to the accuracy of such information. Efforts are underway to better integrate information from third parties. TI has taken and continues to take reasonable steps to provide representative and accurate information but may not have conducted destructive testing or chemical analysis on incoming materials and chemicals. TI and TI suppliers consider certain information to be proprietary, and thus CAS numbers and other limited information may not be available for release.

In no event shall TI's liability arising out of such information exceed the total purchase price of the TI part(s) at issue in this document sold by TI to Customer on an annual basis.

TAPE AND REEL INFORMATION

QUADRANT ASSIGNMENTS FOR PIN 1 ORIENTATION IN TAPE

*All dimensions are nominal

Device	Package Type	Package Drawing	Pins	SPQ	Reel Diameter (mm)	Reel Width W1 (mm)	A0 (mm)	B0 (mm)	K0 (mm)	P1 (mm)	W (mm)	Pin1 Quadrant
LMC6482AIMX	SOIC	D	8	2500	330.0	12.4	6.5	5.4	2.0	8.0	12.0	Q1
LMC6482AIMX/NOPB	SOIC	D	8	2500	330.0	12.4	6.5	5.4	2.0	8.0	12.0	Q1
LMC6482IMM	VSSOP	DGK	8	1000	178.0	12.4	5.3	3.4	1.4	8.0	12.0	Q1
LMC6482IMM/NOPB	VSSOP	DGK	8	1000	178.0	12.4	5.3	3.4	1.4	8.0	12.0	Q1
LMC6482IMMX	VSSOP	DGK	8	3500	330.0	12.4	5.3	3.4	1.4	8.0	12.0	Q1
LMC6482IMMX/NOPB	VSSOP	DGK	8	3500	330.0	12.4	5.3	3.4	1.4	8.0	12.0	Q1
LMC6482IMX	SOIC	D	8	2500	330.0	12.4	6.5	5.4	2.0	8.0	12.0	Q1
LMC6482IMX/NOPB	SOIC	D	8	2500	330.0	12.4	6.5	5.4	2.0	8.0	12.0	Q1

TAPE AND REEL BOX DIMENSIONS

*All dimensions are nominal

Device	Package Type	Package Drawing	Pins	SPQ	Length (mm)	Width (mm)	Height (mm)
LMC6482AIMX	SOIC	D	8	2500	367.0	367.0	35.0
LMC6482AIMX/NOPB	SOIC	D	8	2500	367.0	367.0	35.0
LMC6482IMM	VSSOP	DGK	8	1000	210.0	185.0	35.0
LMC6482IMM/NOPB	VSSOP	DGK	8	1000	210.0	185.0	35.0
LMC6482IMMX	VSSOP	DGK	8	3500	367.0	367.0	35.0
LMC6482IMMX/NOPB	VSSOP	DGK	8	3500	367.0	367.0	35.0
LMC6482IMX	SOIC	D	8	2500	367.0	367.0	35.0
LMC6482IMX/NOPB	SOIC	D	8	2500	367.0	367.0	35.0



D0008A

PACKAGE OUTLINE

SOIC - 1.75 mm max height

SMALL OUTLINE INTEGRATED CIRCUIT



4214825/C 02/2019

NOTES:

- Linear dimensions are in inches [millimeters]. Dimensions in parenthesis are for reference only. Controlling dimensions are in inches. Dimensioning and tolerancing per ASME Y14.5M.
- This drawing is subject to change without notice.
- This dimension does not include mold flash, protrusions, or gate burrs. Mold flash, protrusions, or gate burrs shall not exceed $.006$ [0.15] per side.
- This dimension does not include interlead flash.
- Reference JEDEC registration MS-012, variation AA.

EXAMPLE BOARD LAYOUT

D0008A

SOIC - 1.75 mm max height

SMALL OUTLINE INTEGRATED CIRCUIT



LAND PATTERN EXAMPLE
EXPOSED METAL SHOWN
SCALE:8X



SOLDER MASK DETAILS

4214825/C 02/2019

NOTES: (continued)

6. Publication IPC-7351 may have alternate designs.

7. Solder mask tolerances between and around signal pads can vary based on board fabrication site.

EXAMPLE STENCIL DESIGN

D0008A

SOIC - 1.75 mm max height

SMALL OUTLINE INTEGRATED CIRCUIT



SOLDER PASTE EXAMPLE
BASED ON .005 INCH [0.125 MM] THICK STENCIL
SCALE:8X

4214825/C 02/2019

NOTES: (continued)

8. Laser cutting apertures with trapezoidal walls and rounded corners may offer better paste release. IPC-7525 may have alternate design recommendations.
9. Board assembly site may have different recommendations for stencil design.

P (R-PDIP-T8)

PLASTIC DUAL-IN-LINE PACKAGE



- NOTES:
- A. All linear dimensions are in inches (millimeters).
 - B. This drawing is subject to change without notice.
 - C. Falls within JEDEC MS-001 variation BA.



- NOTES:
- A. All linear dimensions are in millimeters.
 - B. This drawing is subject to change without notice.
 - C. Publication IPC-7351 is recommended for alternate designs.
 - D. Laser cutting apertures with trapezoidal walls and also rounding corners will offer better paste release. Customers should contact their board assembly site for stencil design recommendations. Refer to IPC-7525 for other stencil recommendations.
 - E. Customers should contact their board fabrication site for solder mask tolerances between and around signal pads.

IMPORTANT NOTICE AND DISCLAIMER

TI PROVIDES TECHNICAL AND RELIABILITY DATA (INCLUDING DATASHEETS), DESIGN RESOURCES (INCLUDING REFERENCE DESIGNS), APPLICATION OR OTHER DESIGN ADVICE, WEB TOOLS, SAFETY INFORMATION, AND OTHER RESOURCES "AS IS" AND WITH ALL FAULTS, AND DISCLAIMS ALL WARRANTIES, EXPRESS AND IMPLIED, INCLUDING WITHOUT LIMITATION ANY IMPLIED WARRANTIES OF MERCHANTABILITY, FITNESS FOR A PARTICULAR PURPOSE OR NON-INFRINGEMENT OF THIRD PARTY INTELLECTUAL PROPERTY RIGHTS.

These resources are intended for skilled developers designing with TI products. You are solely responsible for (1) selecting the appropriate TI products for your application, (2) designing, validating and testing your application, and (3) ensuring your application meets applicable standards, and any other safety, security, or other requirements. These resources are subject to change without notice. TI grants you permission to use these resources only for development of an application that uses the TI products described in the resource. Other reproduction and display of these resources is prohibited. No license is granted to any other TI intellectual property right or to any third party intellectual property right. TI disclaims responsibility for, and you will fully indemnify TI and its representatives against, any claims, damages, costs, losses, and liabilities arising out of your use of these resources.

TI's products are provided subject to TI's Terms of Sale (www.ti.com/legal/termsofsale.html) or other applicable terms available either on ti.com or provided in conjunction with such TI products. TI's provision of these resources does not expand or otherwise alter TI's applicable warranties or warranty disclaimers for TI products.

Mailing Address: Texas Instruments, Post Office Box 655303, Dallas, Texas 75265
Copyright © 2019, Texas Instruments Incorporated

Looking for pricing, stock, or lifecycle information?

Click below to explore more details on WIN SOURCE:

 [View LMC6482AIM](#) on WIN SOURCE

 [Texas Instruments](#) Information

Optimize Your Supply Chain with WIN SOURCE Solutions

-  Global Sourcing Solution
-  Obsolete Management
-  Cost Control Management
-  Shortage Management
-  Alternative Solution
-  Excess Inventory Management