

# 2SB1219A

## Silicon PNP epitaxial planar type

For general amplification

Complementary to 2SD1820A

### ■ Features

- Large collector current  $I_C$
- S-Mini type package, allowing downsizing of the equipment and automatic insertion through the tape packing.

### ■ Absolute Maximum Ratings $T_a = 25^\circ\text{C}$

Parameter	Symbol	Rating	Unit
Collector-base voltage (Emitter open)	$V_{CBO}$	-60	V
Collector-emitter voltage (Base open)	$V_{CEO}$	-50	V
Emitter-base voltage (Collector open)	$V_{EBO}$	-5	V
Collector current	$I_C$	-500	mA
Peak collector current	$I_{CP}$	-1	A
Collector power dissipation	$P_C$	150	mW
Junction temperature	$T_j$	150	$^\circ\text{C}$
Storage temperature	$T_{stg}$	-55 to +150	$^\circ\text{C}$

### ■ Package

- Code  
SMini3-G1
- Pin Name
  1. Base
  2. Emitter
  3. Collector

### ■ Marking Symbol: D

### ■ Electrical Characteristics $T_a = 25^\circ\text{C} \pm 3^\circ\text{C}$

Parameter	Symbol	Conditions	Min	Typ	Max	Unit
Collector-base voltage (Emitter open)	$V_{CBO}$	$I_C = -10 \mu\text{A}, I_E = 0$	-60			V
Collector-emitter voltage (Base open)	$V_{CEO}$	$I_C = -2 \text{ mA}, I_B = 0$	-50			V
Emitter-base voltage (Collector open)	$V_{EBO}$	$I_E = -10 \mu\text{A}, I_C = 0$	-5			V
Collector-base cutoff current (Emitter open)	$I_{CBO}$	$V_{CB} = -20 \text{ V}, I_E = 0$			-0.1	$\mu\text{A}$
Forward current transfer ratio *1	$h_{FE1}$ *2	$V_{CE} = -10 \text{ V}, I_C = -150 \text{ mA}$	85		340	—
	$h_{FE2}$	$V_{CE} = -10 \text{ V}, I_C = -500 \text{ mA}$	40			
Collector-emitter saturation voltage *1	$V_{CE(sat)}$	$I_C = -300 \text{ mA}, I_B = -30 \text{ mA}$		-0.35	-0.60	V
Base-emitter saturation voltage *1	$V_{BE(sat)}$	$I_C = -300 \text{ mA}, I_B = -30 \text{ mA}$		-1.1	-1.5	V
Transition frequency	$f_T$	$V_{CB} = -10 \text{ V}, I_E = 50 \text{ mA}, f = 200 \text{ MHz}$		200		MHz
Collector output capacitance (Common base, input open circuited)	$C_{ob}$	$V_{CB} = -10 \text{ V}, I_E = 0, f = 1 \text{ MHz}$		6	15	pF

Note) 1. Measuring methods are based on JAPANESE INDUSTRIAL STANDARD JIS C 7030 measuring methods for transistors.

2. \*1: Pulse measurement

\*2: Rank classification

Rank	Q	R	S	No-rank
$h_{FE1}$	85 to 170	120 to 240	170 to 340	85 to 340
Marking symbol	DQ	DR	DS	D

Product of no-rank is not classified and have no marking symbol for rank.

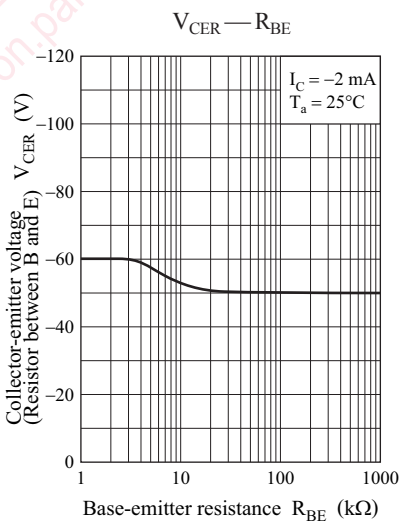
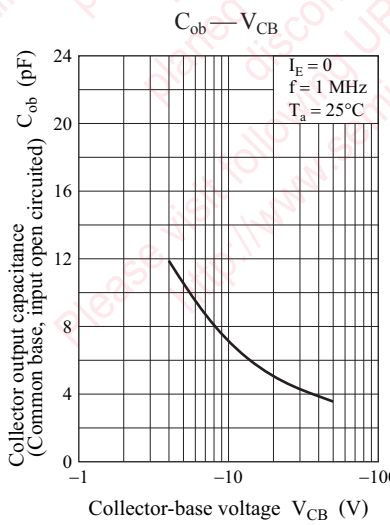
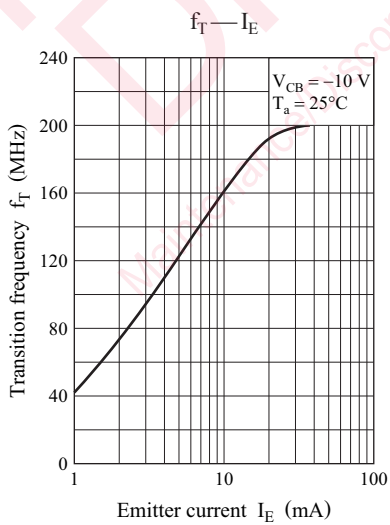
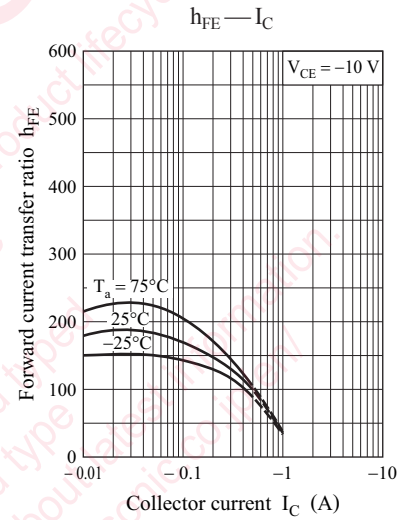
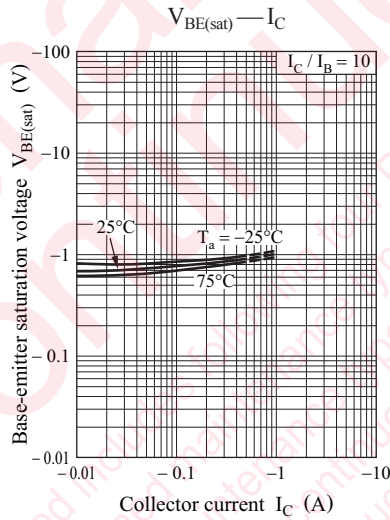
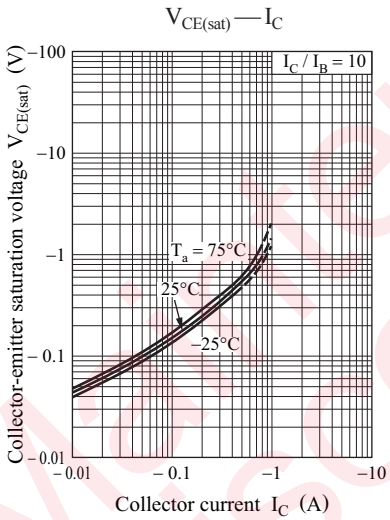
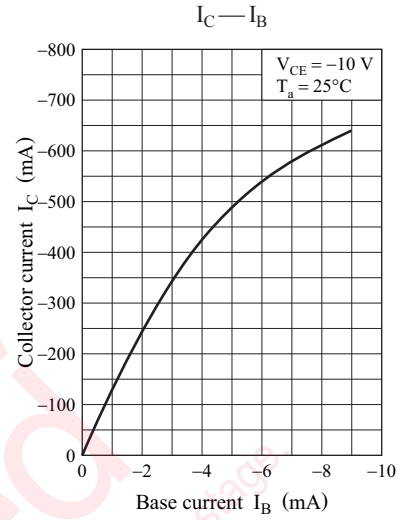
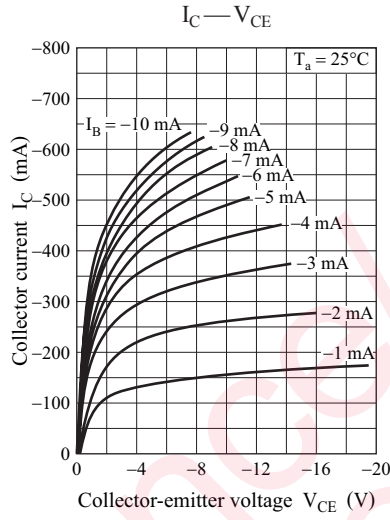
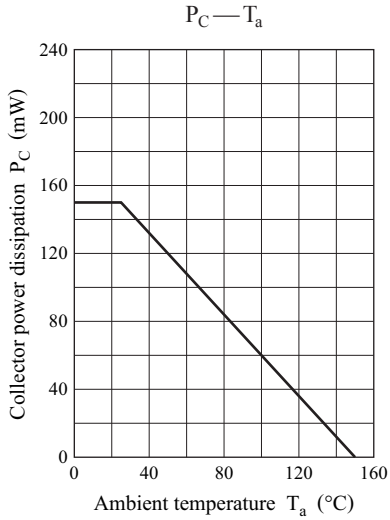

SMini3-G1

Unit: mm

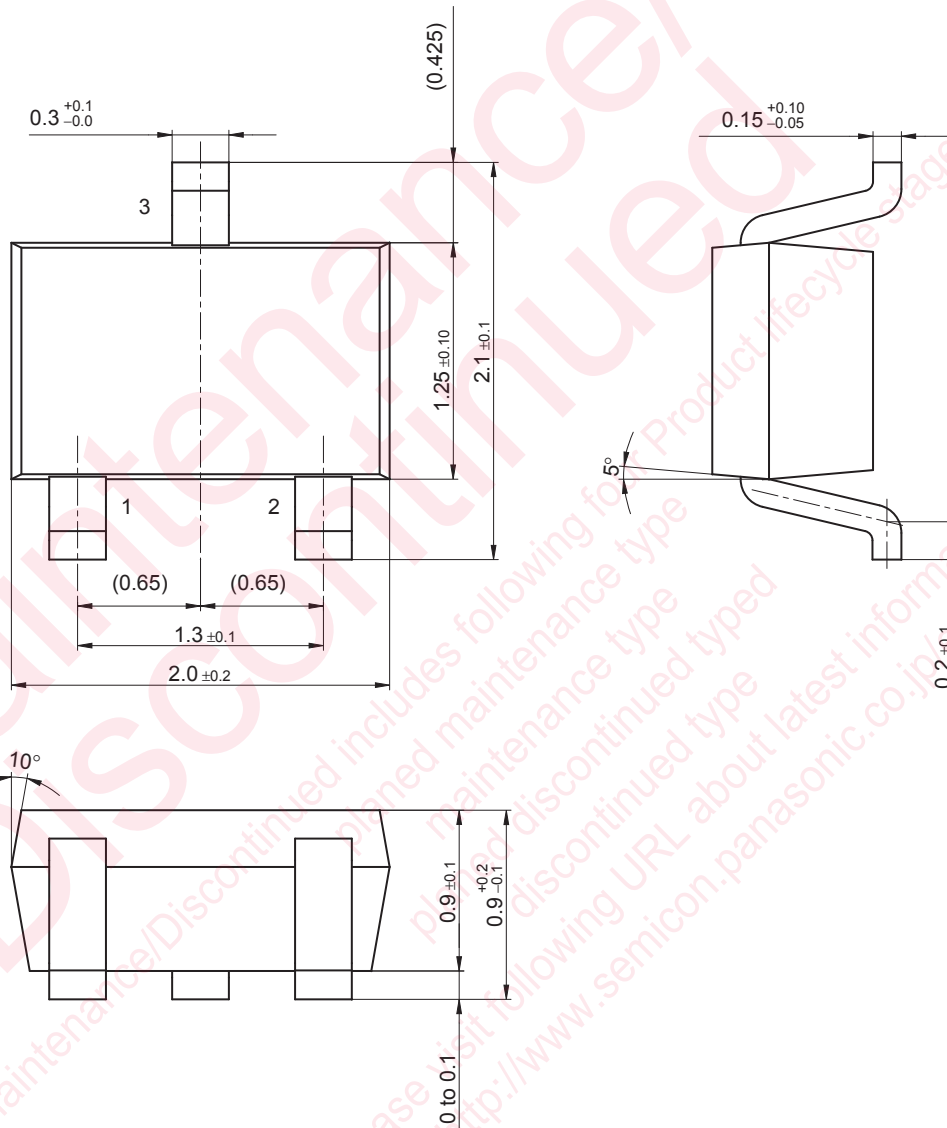

## Precautions in using the technical information and products described in this book

This book is to be exported or provided to non-residents, the laws and regulations related to security export control, must be observed.

This book is to show the main characteristics and application circuit examples of the products. It does not constitute a warranty of any kind, property right or other right owned by Panasonic Corporation or any other company as to the infringement upon any such right owned by any other company. The information described in this book is for reference only.

This book is for standard applications or general electronic equipment (such as office equipment and household appliances).

Special applications:

Automobiles, traffic control equipment, combustion equipment, life support equipment, etc. where high reliability are required, or if the failure or malfunction of the product may cause serious damage to life or property.

Products are subject to change without notice for modification and/or improvement of the products, therefore, ask for the most up-to-date Product Information Sheet to satisfy your requirements.

Do not exceed the absolute maximum rating and the guaranteed operating conditions (such as temperature range). Especially, please be careful not to exceed the range of absolute maximum rating for turn-on and mode-switching. Otherwise, we will not be liable for any damage or loss.

Please take into the consideration of incidence of break down and failure in the systems such as redundant design, arresting the spread of fire and explosion, fire, social damages, for example, by using the products.

Performance and characteristics change due to external factors (ESD, EOS, etc.) during mounting or at customer's process. When using products for which reliability is required, please refer to the shelf life and the elapsed time since first opening the packages.

Reproduction or distribution, partially, without the prior written permission of our company.

## Looking for pricing, stock, or lifecycle information?

Click below to explore more details on WIN SOURCE:

- [View 2SB1219A-\(TX\) on WIN SOURCE](#)
- [Panasonic Information](#)

## Optimize Your Supply Chain with WIN SOURCE Solutions

- ✓ Global Sourcing Solution
- ✓ Obsolete Management
- ✓ Cost Control Management
- ✓ Shortage Management
- ✓ Alternative Solution
- ✓ Excess Inventory Management