



**THE DATASHEET OF
LMV321SQ3T2G**



LMV321, NCV321, LMV358, LMV324

Single, Dual, Quad Low-Voltage, Rail-to-Rail Operational Amplifiers

The LMV321, NCV321, LMV358, and LMV324 are CMOS single, dual, and quad low voltage operational amplifiers with rail-to-rail output swing. These amplifiers are a cost-effective solution for applications where low power consumption and space saving packages are critical. Specification tables are provided for operation from power supply voltages at 2.7 V and 5 V. Rail-to-Rail operation provides improved signal-to-noise performance. Ultra low quiescent current makes this series of amplifiers ideal for portable, battery operated equipment. The common mode input range includes ground making the device useful for low-side current-shunt measurements. The ultra small packages allow for placement on the PCB in close proximity to the signal source thereby reducing noise pickup.

Features

- Operation from 2.7 V to 5.0 V Single-Sided Power Supply
- LMV321 Single Available in Ultra Small 5 Pin SC70 Package
- No Output Crossover Distortion
- Rail-to-Rail Output
- Low Quiescent Current: LMV358 Dual – 220 μ A, Max per Channel
- No Output Phase-Reversal from Overdriven Input
- NCV Prefix for Automotive and Other Applications Requiring Unique Site and Control Change Requirements; AEC-Q100 Qualified and PPAP Capable
- These Devices are Pb-Free, Halogen Free/BFR Free and are RoHS Compliant

Typical Applications

- Notebook Computers and PDA's
- Portable Battery-Operated Instruments
- Active Filters



ON Semiconductor®

www.onsemi.com

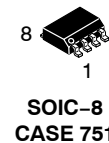
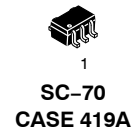

ORDERING AND MARKING INFORMATION

See detailed ordering and shipping information in the package dimensions section on page 12 of this data sheet.

LMV321, NCV321, LMV358, LMV324

MARKING DIAGRAMS

SC-70

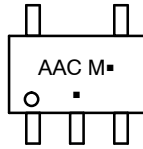

AAC = Specific Device Code
 M = Date Code
 ■ = Pb-Free Package
 (Note: Microdot may be in either location)

TSOP-5

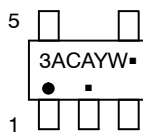

3AC = Specific Device Code
 A = Assembly Location
 Y = Year
 W = Work Week
 ■ = Pb-Free Package
 (Note: Microdot may be in either location)

Micro8

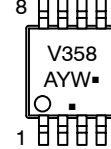

V358 = Specific Device Code
 A = Assembly Location
 Y = Year
 W = Work Week
 ■ = Pb-Free Package
 (Note: Microdot may be in either location)

SOIC-8

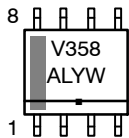

V358 = Specific Device Code
 A = Assembly Location
 L = Wafer Lot
 Y = Year
 W = Work Week
 ■ = Pb-Free Package

UDFN8

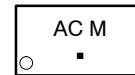

AC = Specific Device Code
 M = Date Code
 ■ = Pb-Free Package

SOIC-14

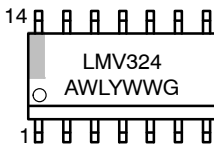

LMV324 = Specific Device Code
 A = Assembly Location
 WL = Wafer Lot
 Y = Year
 WW = Work Week
 G = Pb-Free Package

TSSOP-14

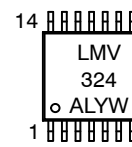

LMV324 = Specific Device Code
 A = Assembly Location
 L = Wafer Lot
 Y = Year
 W = Work Week
 ■ = Pb-Free Package

PIN CONNECTIONS

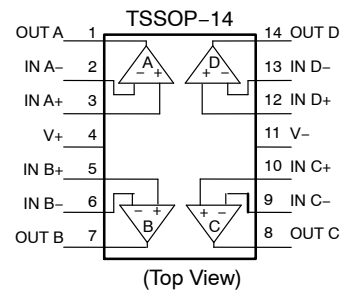
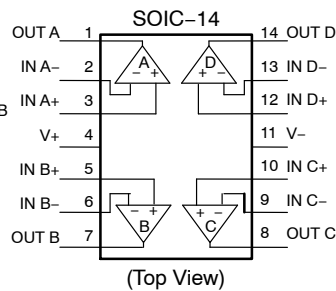
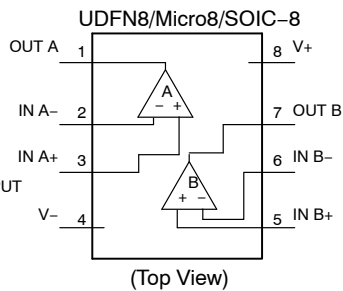
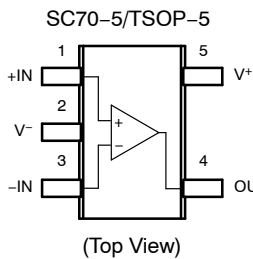

LMV321, NCV321, LMV358, LMV324

MAXIMUM RATINGS

Symbol	Rating	Value	Unit
V _S	Supply Voltage (Operating Range V _S = 2.7 V to 5.5 V)	5.5	V
V _{IDR}	Input Differential Voltage	± Supply Voltage	V
V _{ICR}	Input Common Mode Voltage Range	-0.5 to (V+) + 0.5	V
	Maximum Input Current	10	mA
t _{So}	Output Short Circuit (Note 1)	Continuous	
T _J	Maximum Junction Temperature	150	°C
T _A	Operating Ambient Temperature Range LMV321, LMV358, LMV324 NCV321 (Note 2)	-40°C to 85°C -40°C to 125°C	°C °C
θ _{JA}	Thermal Resistance:		°C/W
	SC-70	280	
	Micro8	238	
	TSOP-5	333	
	UDFN8 (1.2 mm x 1.8 mm x 0.5 mm)	350	
	SOIC-8	212	
	SOIC-14	156	
	TSSOP-14	190	
T _{stg}	Storage Temperature	-65 to 150	°C
	Mounting Temperature (Infrared or Convection -20 sec)	260	°C
V _{ESD}	ESD Tolerance (Note 3)		V
	LMV321, NCV321		
	Machine Model	100	
	Human Body Model	1000	
LMV358/324			
Machine Model	100		
Human Body Mode	2000		

Stresses exceeding those listed in the Maximum Ratings table may damage the device. If any of these limits are exceeded, device functionality should not be assumed, damage may occur and reliability may be affected.

1. Continuous short-circuit operation to ground at elevated ambient temperature can result in exceeding the maximum allowed junction temperature of 150°C. Output currents in excess of 45 mA over long term may adversely affect reliability. Shorting output to either V+ or V- will adversely affect reliability.
2. NCV prefix is qualified for automotive usage.
3. Human Body Model, applicable std. MIL-STD-883, Method 3015.7
Machine Model, applicable std. JESD22-A115-A (ESD MM std. of JEDEC)
Field-Induced Charge-Device Model, applicable std. JESD22-C101-C (ESD FICDM std. of JEDEC).

LMV321, NCV321, LMV358, LMV324

2.7 V DC ELECTRICAL CHARACTERISTICS (Unless otherwise specified, all limits are guaranteed for $T_A = 25^\circ\text{C}$, $V^+ = 2.7\text{ V}$, $R_L = 1\text{ M}\Omega$, $V^- = 0\text{ V}$, $V_O = V^+/2$)

Parameter	Symbol	Condition	Min	Typ	Max	Unit
Input Offset Voltage	V_{IO}	$T_A = T_{Low}$ to T_{High} (Note 4)		1.7	9	mV
Input Offset Voltage Average Drift	ICV_{OS}	$T_A = T_{Low}$ to T_{High} (Note 4)		5		$\mu\text{V}/^\circ\text{C}$
Input Bias Current	I_B	$T_A = T_{Low}$ to T_{High} (Note 4)		<1		nA
Input Offset Current	I_{IO}	$T_A = T_{Low}$ to T_{High} (Note 4)		<1		nA
Common Mode Rejection Ratio	CMRR	$0\text{ V} \leq V_{CM} \leq 1.7\text{ V}$	50	63		dB
Power Supply Rejection Ratio	PSRR	$2.7\text{ V} \leq V^+ \leq 5\text{ V}$, $V_O = 1\text{ V}$	50	60		dB
Input Common-Mode Voltage Range	V_{CM}	For CMRR $\geq 50\text{ dB}$	0 to 1.7	-0.2 to 1.9		V
Output Swing	V_{OH}	$R_L = 10\text{ k}\Omega$ to 1.35 V	$V_{CC} - 100$	$V_{CC} - 10$		mV
	V_{OL}	$R_L = 10\text{ k}\Omega$ to 1.35 V (Note 5)		60	180	mV
Supply Current LMV321, NCV321 LMV358 (Both Amplifiers) LMV324 (4 Amplifiers)	I_{CC}			80 140 260	185 340 680	μA

2.7 V AC ELECTRICAL CHARACTERISTICS (Unless otherwise specified, all limits are guaranteed for $T_A = 25^\circ\text{C}$, $V^+ = 2.7\text{ V}$, $R_L = 1\text{ M}\Omega$, $V^- = 0\text{ V}$, $V_O = V^+/2$)

Parameter	Symbol	Condition	Min	Typ	Max	Unit
Gain Bandwidth Product	GBWP	$C_L = 200\text{ pF}$		1		MHz
Phase Margin	Θ_m			60		$^\circ$
Gain Margin	G_m			10		dB
Input-Referred Voltage Noise	e_n	$f = 50\text{ kHz}$		50		$\text{nV}/\sqrt{\text{Hz}}$

Product parametric performance is indicated in the Electrical Characteristics for the listed test conditions, unless otherwise noted. Product performance may not be indicated by the Electrical Characteristics if operated under different conditions.

4. For LMV321, LMV358, LMV324: $T_A = -40^\circ\text{C}$ to $+85^\circ\text{C}$

For NCV321: $T_A = -40^\circ\text{C}$ to $+125^\circ\text{C}$.

5. Guaranteed by design and/or characterization.

LMV321, NCV321, LMV358, LMV324

5.0 V DC ELECTRICAL CHARACTERISTICS (Unless otherwise specified, all limits are guaranteed for $T_A = 25^\circ\text{C}$, $V^+ = 5.0\text{ V}$, $R_L = 1\text{ M}\Omega$, $V^- = 0\text{ V}$, $V_O = V^+/2$)

Parameter	Symbol	Condition	Min	Typ	Max	Unit
Input Offset Voltage	V_{IO}	$T_A = T_{Low}$ to T_{High} (Note 6)		1.7	9	mV
Input Offset Voltage Average Drift	$T_C V_{IO}$	$T_A = T_{Low}$ to T_{High} (Note 6)		5		$\mu\text{V}/^\circ\text{C}$
Input Bias Current (Note 7)	I_B	$T_A = T_{Low}$ to T_{High} (Note 6)		< 1		nA
Input Offset Current (Note 7)	I_{IO}	$T_A = T_{Low}$ to T_{High} (Note 6)		< 1		nA
Common Mode Rejection Ratio	CMRR	$0\text{ V} \leq V_{CM} \leq 4\text{ V}$	50	65		dB
Power Supply Rejection Ratio	PSRR	$2.7\text{ V} \leq V^+ \leq 5\text{ V}$, $V_O = 1\text{ V}$, $V_{CM} = 1\text{ V}$	50	60		dB
Input Common-Mode Voltage Range	V_{CM}	For CMRR $\geq 50\text{ dB}$	0 to 4	-0.2 to 4.2		V
Large Signal Voltage Gain (Note 7)	A_V	$R_L = 2\text{ k}\Omega$	15	100		V/mV
		$T_A = T_{Low}$ to T_{High} (Note 6)	10			
Output Swing	V_{OH}	$R_L = 2\text{ k}\Omega$ to 2.5 V $T_A = T_{Low}$ to T_{High} (Note 6)	$V_{CC} - 300$ $V_{CC} - 400$	$V_{CC} - 40$		mV
	V_{OL}	$R_L = 2\text{ k}\Omega$ to 2.5 V (Note 7) $T_A = T_{Low}$ to T_{High} (Note 6)		120	300 400	mV
	V_{OH}	$R_L = 10\text{ k}\Omega$ to 2.5 V (Note 7) $T_A = T_{Low}$ to T_{High} (Note 6)	$V_{CC} - 100$ $V_{CC} - 200$			mV
	V_{OL}	$R_L = 10\text{ k}\Omega$ to 2.5 V $T_A = T_{Low}$ to T_{High} (Note 6)		65	180 280	mV
Output Short Circuit Current	I_O	Sourcing = $V_O = 0\text{ V}$ (Note 7)	10	60		mA
		Sinking = $V_O = 5\text{ V}$ (Note 7)	10	160		
Supply Current	I_{CC}	LMV321 $T_A = T_{Low}$ to T_{High} (Note 6)		130	250 350	μA
		NCV321 $T_A = T_{Low}$ to T_{High} (Note 6)		130	250 350	
		LMV358 Both Amplifiers $T_A = T_{Low}$ to T_{High} (Note 6)		210	440 615	
		LMV324 All Four Amplifiers $T_A = T_{Low}$ to T_{High} (Note 6)		410	830 1160	

5.0 V AC ELECTRICAL CHARACTERISTICS (Unless otherwise specified, all limits are guaranteed for $T_A = 25^\circ\text{C}$, $V^+ = 5.0\text{ V}$, $R_L = 1\text{ M}\Omega$, $V^- = 0\text{ V}$, $V_O = V^+/2$)

Parameter	Symbol	Condition	Min	Typ	Max	Unit
Slew Rate	S_R			1		V/ μs
Gain Bandwidth Product	GBWP	$C_L = 200\text{ pF}$		1		MHz
Phase Margin	Θ_m			60		$^\circ$
Gain Margin	G_m			10		dB
Input-Referred Voltage Noise	e_n	$f = 50\text{ kHz}$		50		$\text{nV}/\sqrt{\text{Hz}}$

Product parametric performance is indicated in the Electrical Characteristics for the listed test conditions, unless otherwise noted. Product performance may not be indicated by the Electrical Characteristics if operated under different conditions.

6. For LMV321, LMV358, LMV324: $T_A = -40^\circ\text{C}$ to $+85^\circ\text{C}$

For NCV321: $T_A = -40^\circ\text{C}$ to $+125^\circ\text{C}$.

7. Guaranteed by design and/or characterization.

TYPICAL CHARACTERISTICS

($T_A = 25^\circ\text{C}$ and $V_S = 5\text{ V}$ unless otherwise specified)

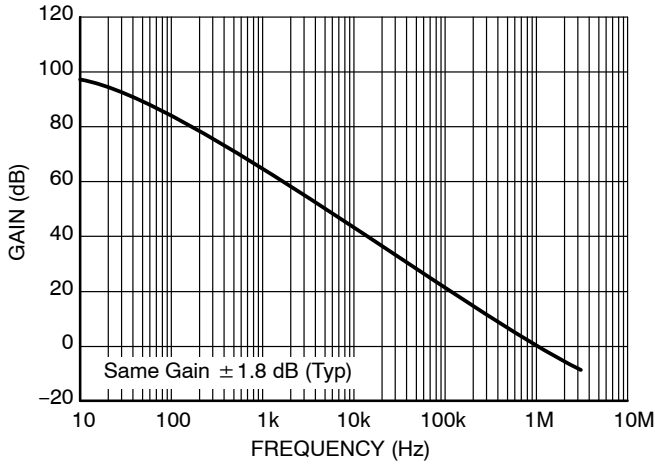

Figure 1. Open Loop Frequency Response
($R_L = 2\text{ k}\Omega$, $T_A = 25^\circ\text{C}$, $V_S = 5\text{ V}$)

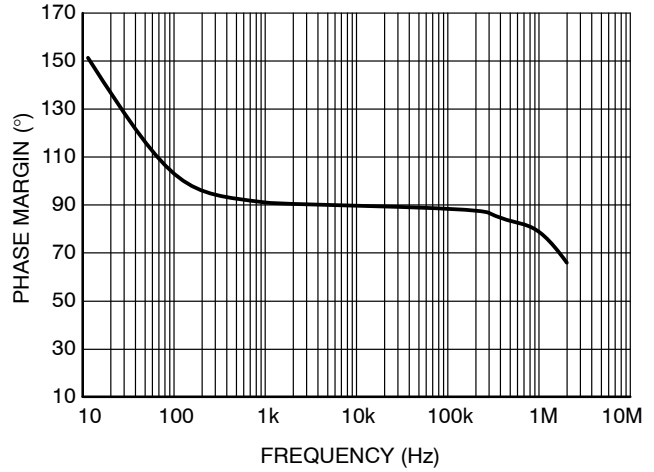

Figure 2. Open Loop Phase Margin
($R_L = 2\text{ k}\Omega$, $T_A = 25^\circ\text{C}$, $V_S = 5\text{ V}$)

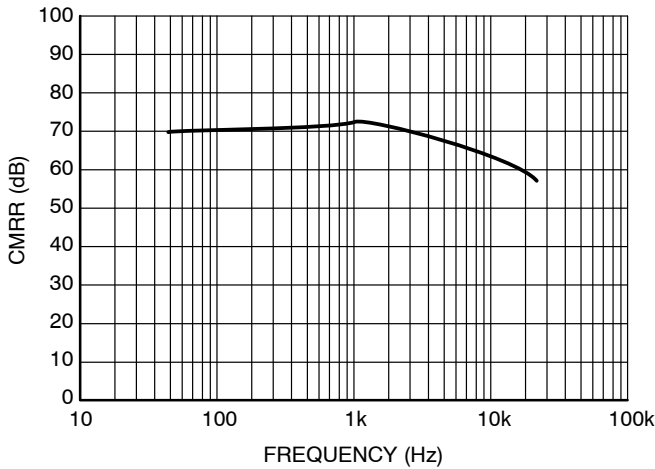

Figure 3. CMRR vs. Frequency
($R_L = 5\text{ k}\Omega$, $V_S = 5\text{ V}$)

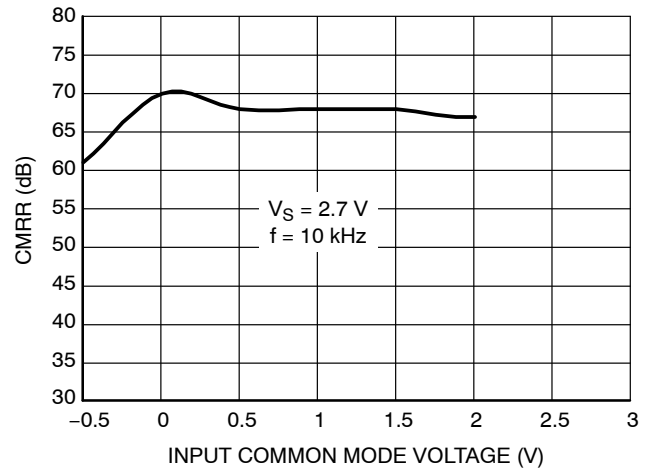

Figure 4. CMRR vs. Input Common Mode Voltage

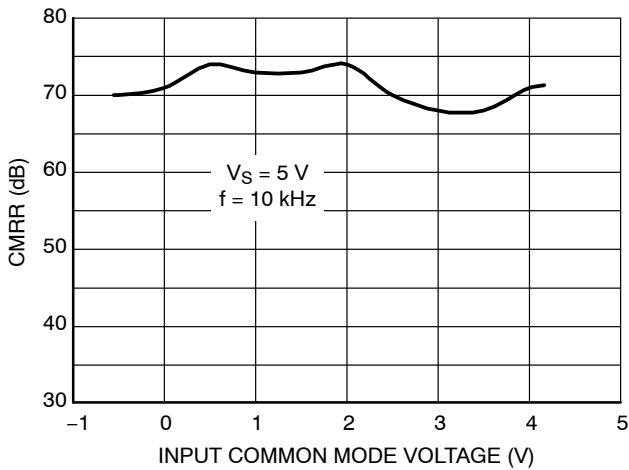

Figure 5. CMRR vs. Input Common Mode Voltage

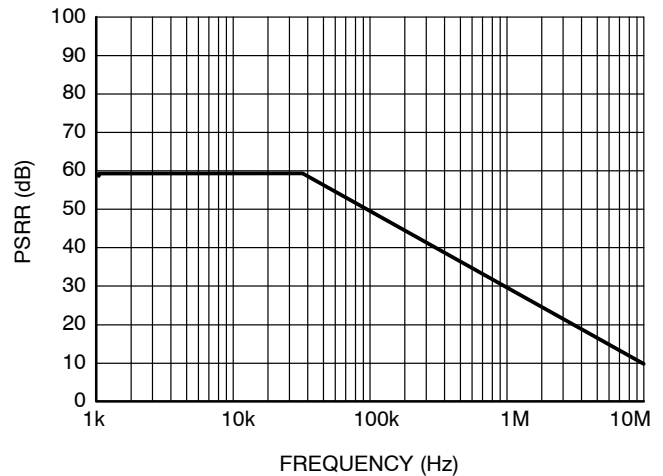

Figure 6. PSRR vs. Frequency
($R_L = 5\text{ k}\Omega$, $V_S = 2.7\text{ V}$, +PSRR)

LMV321, NCV321, LMV358, LMV324

TYPICAL CHARACTERISTICS

($T_A = 25^\circ\text{C}$ and $V_S = 5\text{ V}$ unless otherwise specified)

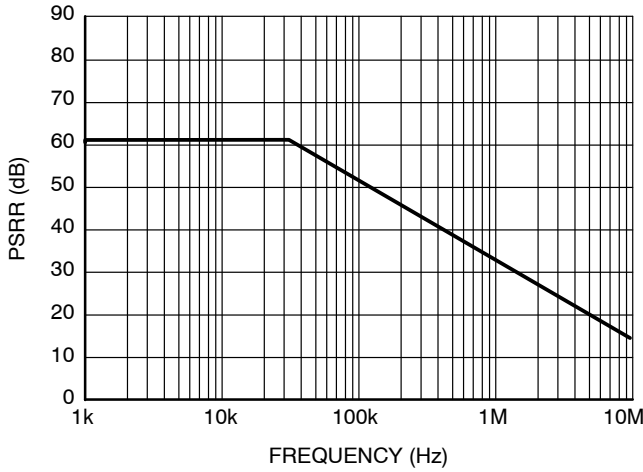

Figure 7. PSRR vs. Frequency
($R_L = 5\text{ k}\Omega$, $V_S = 2.7\text{ V}$, -PSRR)

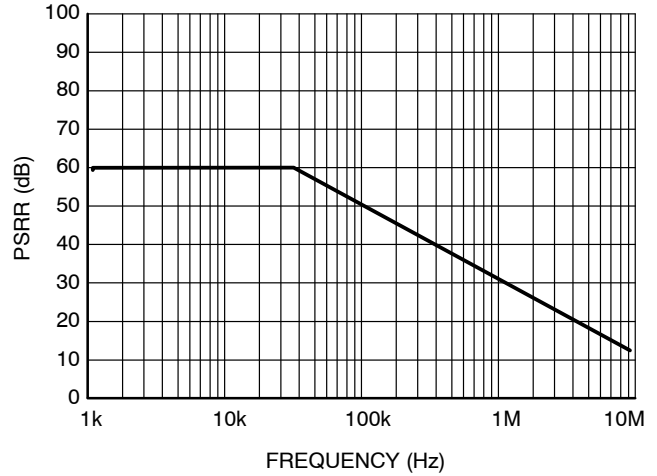

Figure 8. PSRR vs. Frequency
($R_L = 5\text{ k}\Omega$, $V_S = 5\text{ V}$, +PSRR)

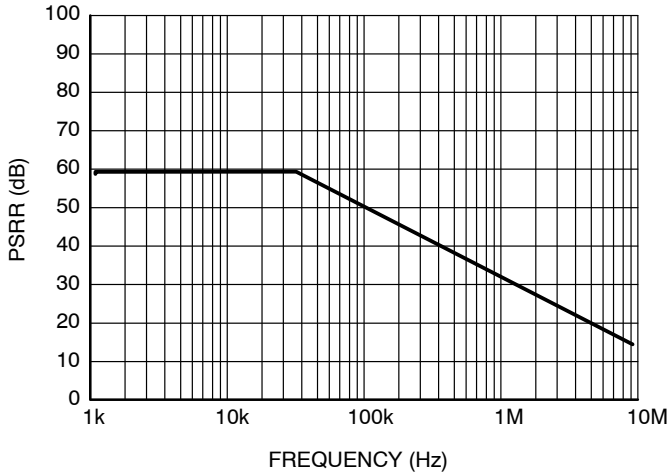

Figure 9. PSRR vs. Frequency
($R_L = 5\text{ k}\Omega$, $V_S = 5\text{ V}$, -PSRR)

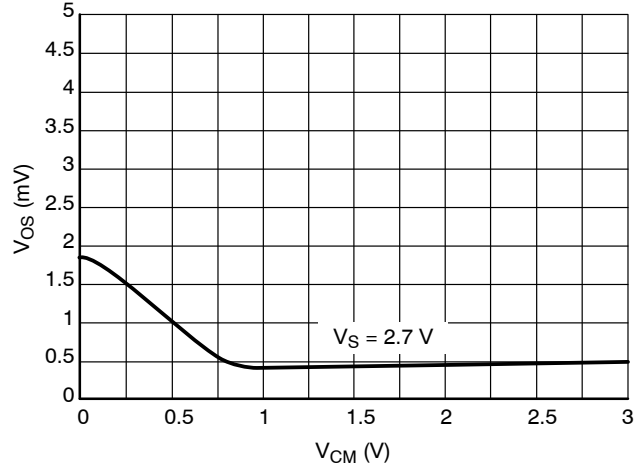

Figure 10. V_{OS} vs. CMR

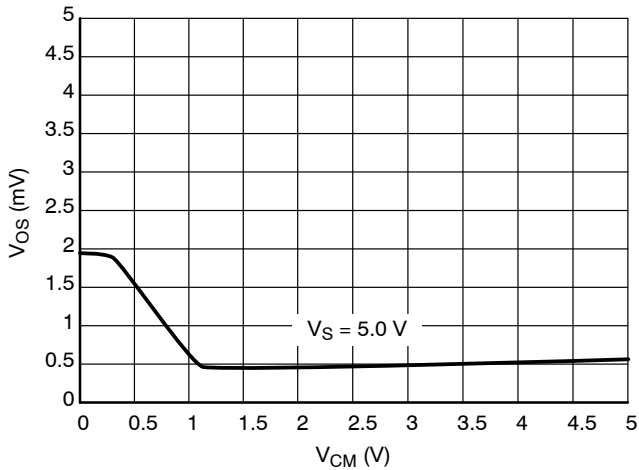

Figure 11. V_{OS} vs. CMR

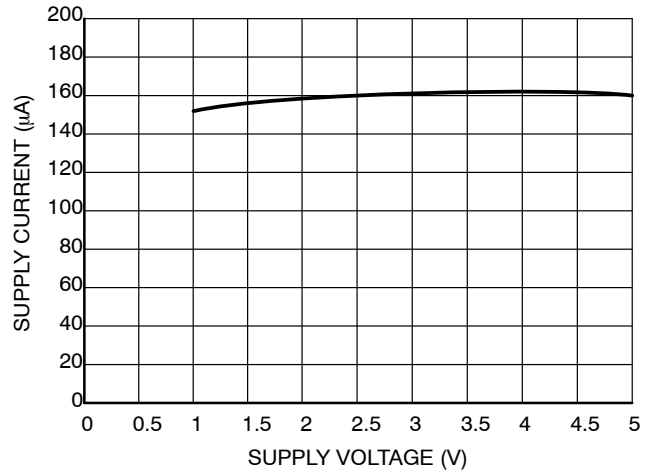

Figure 12. Supply Current vs. Supply Voltage

LMV321, NCV321, LMV358, LMV324

TYPICAL CHARACTERISTICS

($T_A = 25^\circ\text{C}$ and $V_S = 5\text{ V}$ unless otherwise specified)

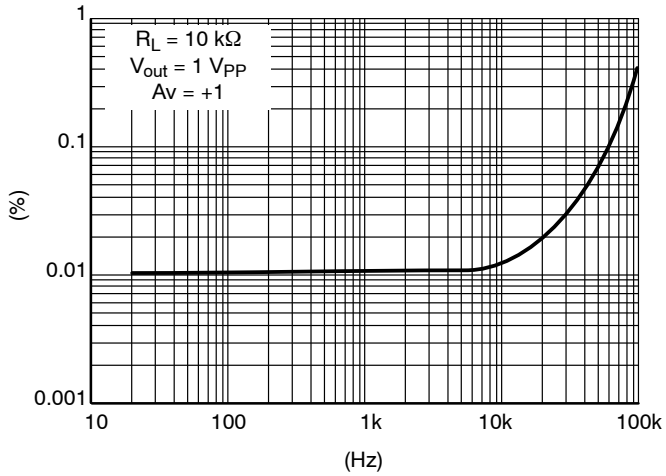

Figure 13. THD+N vs Frequency

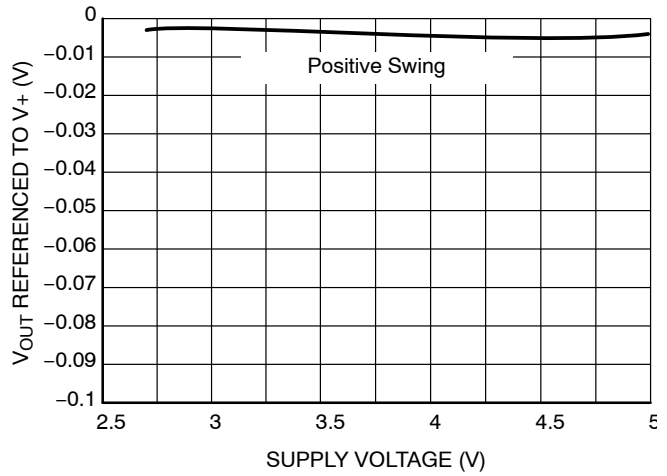

Figure 14. Output Voltage Swing vs Supply Voltage ($R_L = 10\text{ k}$)

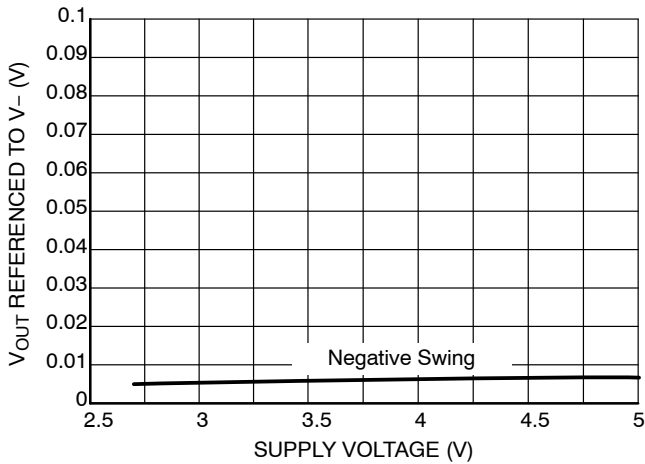

Figure 15. Output Voltage Swing vs Supply Voltage ($R_L = 10\text{ k}$)

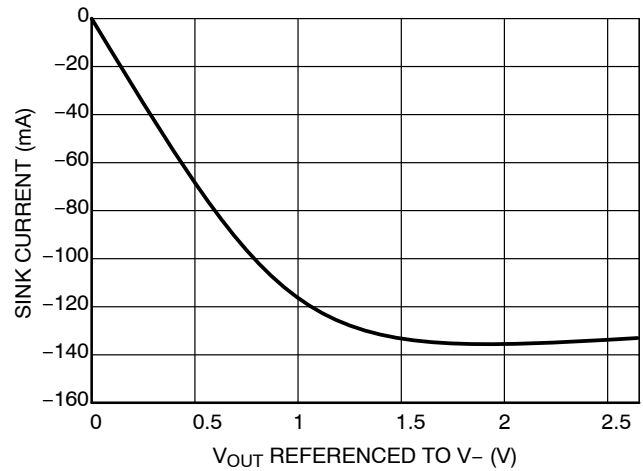

Figure 16. Sink Current vs. Output Voltage
 $V_S = 2.7\text{ V}$

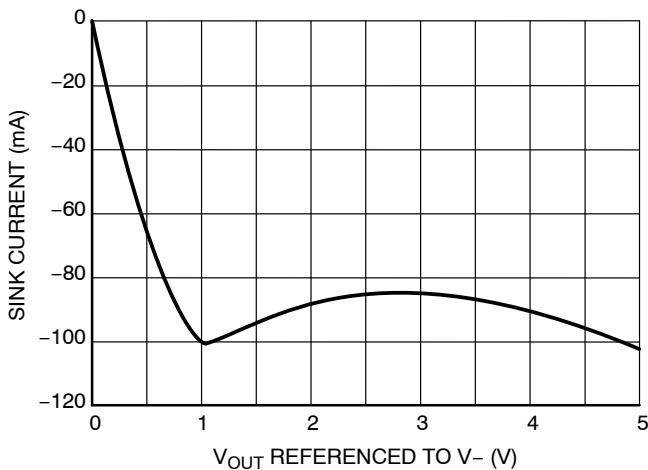

Figure 17. Sink Current vs. Output Voltage
 $V_S = 5.0\text{ V}$

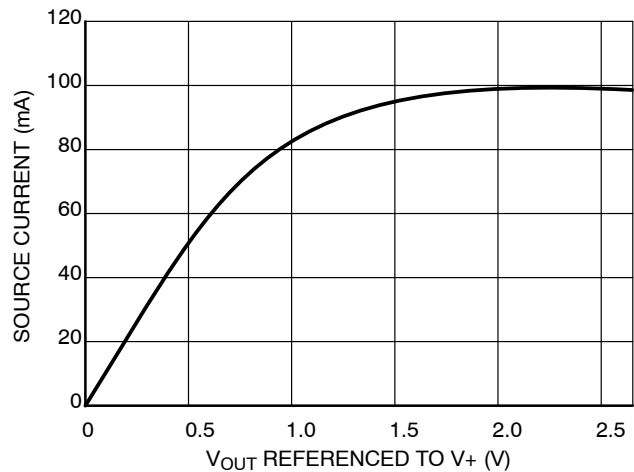

Figure 18. Source Current vs. Output Voltage
 $V_S = 2.7\text{ V}$

LMV321, NCV321, LMV358, LMV324

TYPICAL CHARACTERISTICS

($T_A = 25^\circ\text{C}$ and $V_S = 5\text{ V}$ unless otherwise specified)

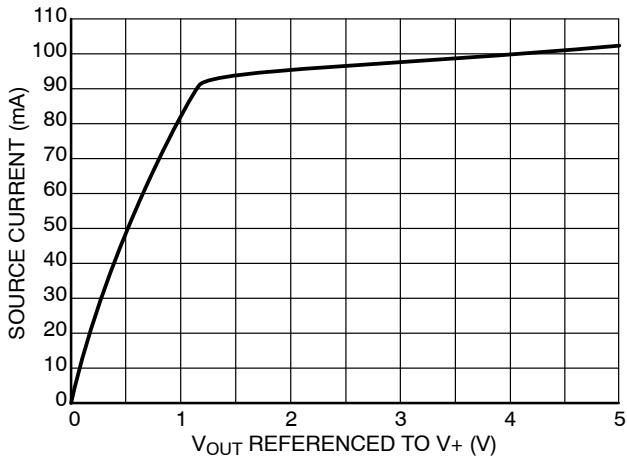

Figure 19. Source Current vs. Output Voltage
 $V_S = 5.0\text{ V}$

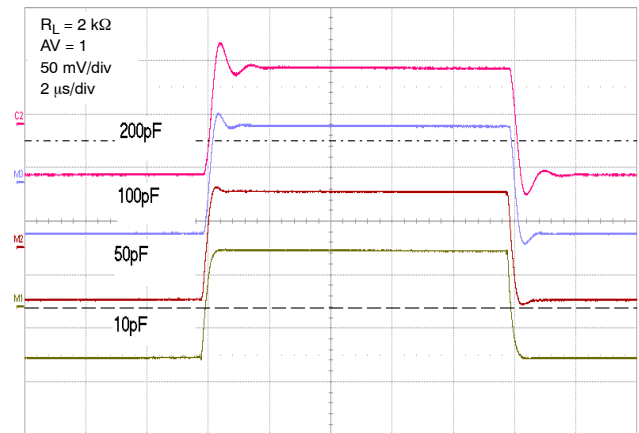

Figure 20. Settling Time vs. Capacitive Load

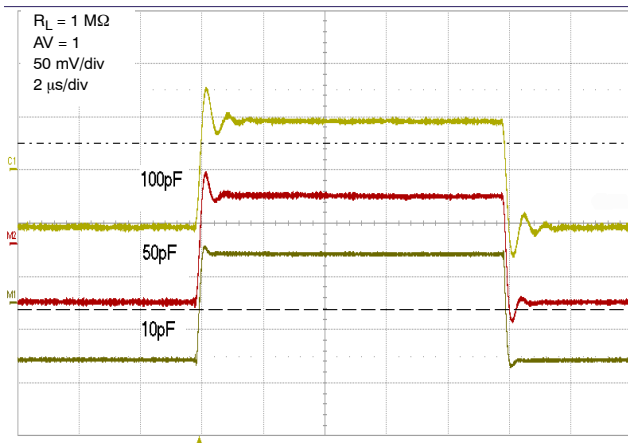

Figure 21. Settling Time vs. Capacitive Load

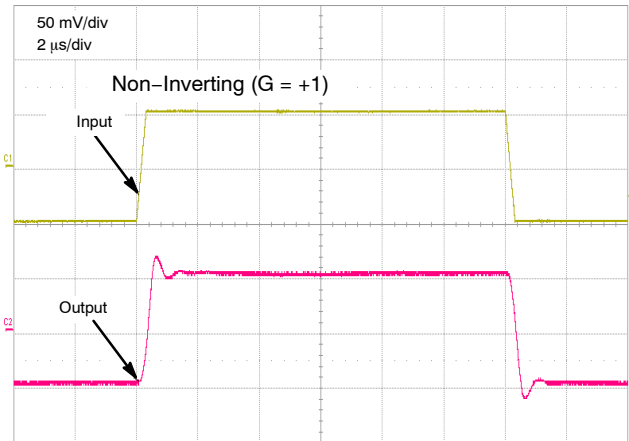

Figure 22. Step Response – Small Signal

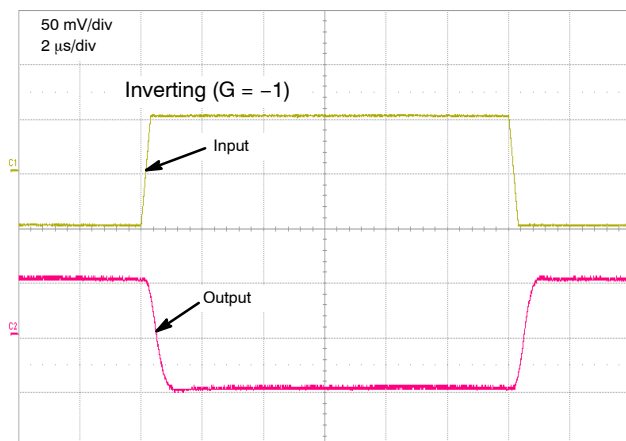

Figure 23. Step Response – Small Signal

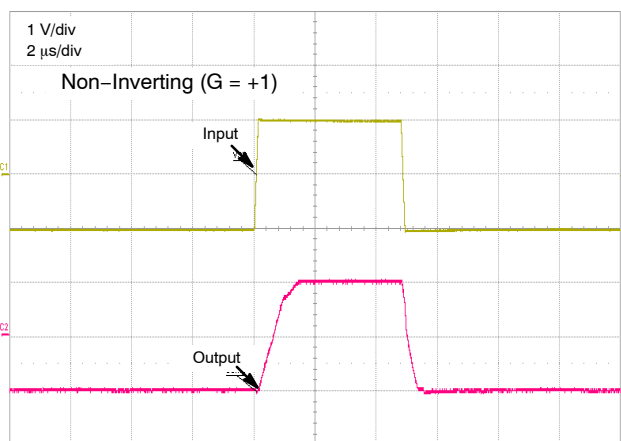

Figure 24. Step Response – Large Signal

LMV321, NCV321, LMV358, LMV324

TYPICAL CHARACTERISTICS

($T_A = 25^\circ\text{C}$ and $V_S = 5\text{ V}$ unless otherwise specified)

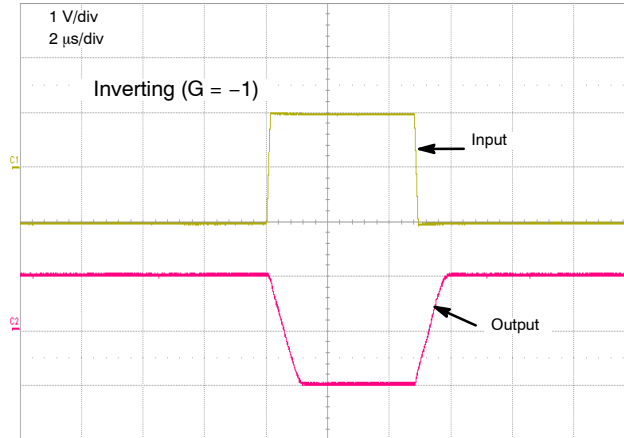

Figure 25. Step Response – Large Signal

APPLICATIONS

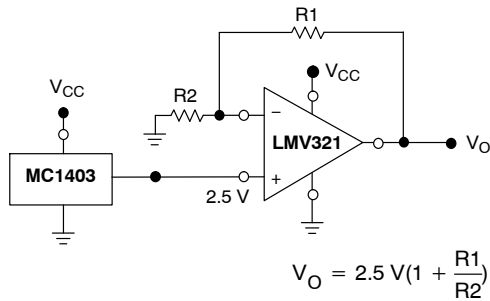

Figure 26. Voltage Reference

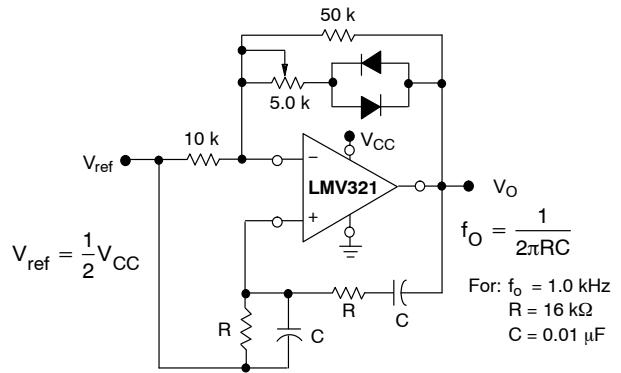

Figure 27. Wien Bridge Oscillator

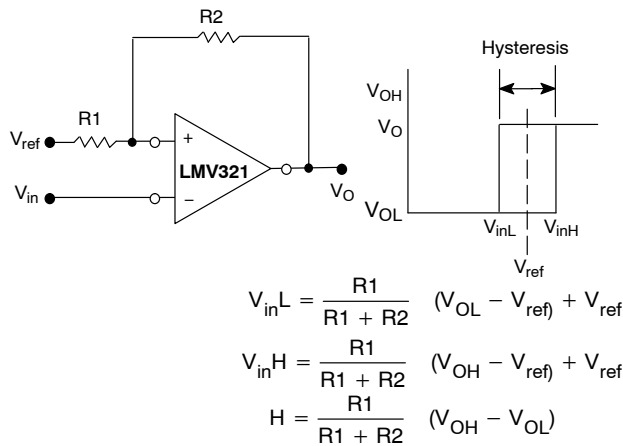
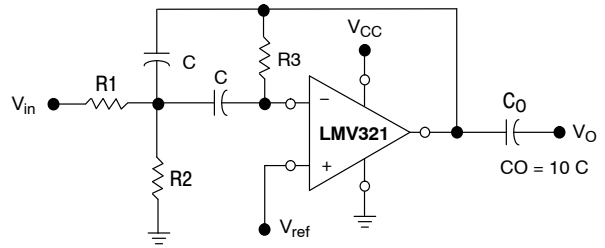

Figure 28. Comparator with Hysteresis



Given: f_o = center frequency
 $A(f_o)$ = gain at center frequency

Choose value f_o, C

Then: $R_3 = \frac{Q}{\pi f_o C}$

$$R_1 = \frac{R_3}{2 A(f_o)}$$

$$R_2 = \frac{R_1 R_3}{4Q^2 R_1 - R_3}$$

For less than 10% error from operational amplifier,
 $((Q_o f_o)/BW) < 0.1$ where f_o and BW are expressed in Hz.
 If source impedance varies, filter may be preceded with
 voltage follower buffer to stabilize filter parameters.

Figure 29. Multiple Feedback Bandpass Filter

LMV321, NCV321, LMV358, LMV324

ORDERING INFORMATION

Order Number	Number of Channels	Specific Device Marking	Package Type	Shipping†
LMV321SQ3T2G	Single	AAC	SC-70 (Pb-Free)	3000 / Tape & Reel
LMV321SN3T1G	Single	3AC	TSOP-5 (Pb-Free)	3000 / Tape & Reel
NCV321SN3T1G*	Single	3AC	TSOP-5 (Pb-Free)	3000 / Tape & Reel
LMV358DMR2G	Dual	V358	Micro8 (Pb-Free)	4000 / Tape & Reel
LMV358MUTAG	Dual	AC	UDFN8 (Pb-Free)	3000 / Tape & Reel
LMV358DR2G	Dual	V358	SOIC-8 (Pb-Free)	2500 / Tape & Reel
LMV324DR2G	Quad	LMV324	SOIC-14 (Pb-Free)	2500 / Tape & Reel
LMV324DTBR2G	Quad	LMV 324	TSSOP-14 (Pb-Free)	2500 / Tape & Reel

†For information on tape and reel specifications, including part orientation and tape sizes, please refer to our Tape and Reel Packaging Specifications Brochure, BRD8011/D.

*NCV Prefix for Automotive and Other Applications Requiring Unique Site and Control Change Requirements; AEC-Q100 Qualified and PPAP Capable.

LMV321, NCV321, LMV358, LMV324

PACKAGE DIMENSIONS

SC-88A (SC-70-5/SOT-353)

CASE 419A-02

ISSUE L

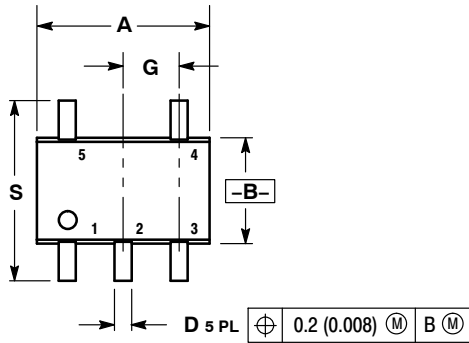

NOTES:

1. DIMENSIONING AND TOLERANCING PER ANSI Y14.5M, 1982.
2. CONTROLLING DIMENSION: INCH.
3. 419A-01 OBSOLETE. NEW STANDARD 419A-02.
4. DIMENSIONS A AND B DO NOT INCLUDE MOLD FLASH, PROTRUSIONS, OR GATE BURRS.

DIM	INCHES		MILLIMETERS	
	MIN	MAX	MIN	MAX
A	0.071	0.087	1.80	2.20
B	0.045	0.053	1.15	1.35
C	0.031	0.043	0.80	1.10
D	0.004	0.012	0.10	0.30
G	0.026 BSC		0.65 BSC	
H	---	0.004	---	0.10
J	0.004	0.010	0.10	0.25
K	0.004	0.012	0.10	0.30
N	0.008 REF		0.20 REF	
S	0.079	0.087	2.00	2.20

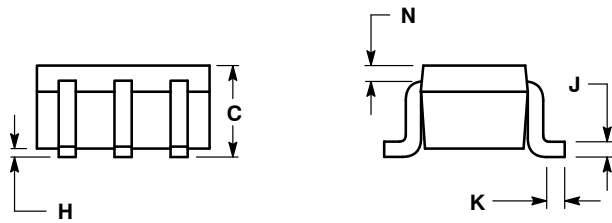

SOLDER FOOTPRINT

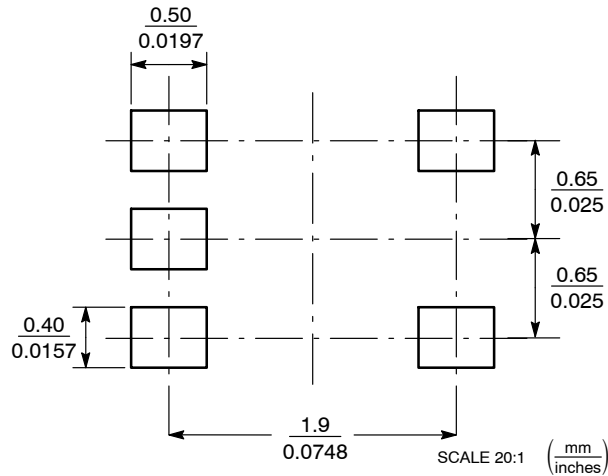

LMV321, NCV321, LMV358, LMV324

PACKAGE DIMENSIONS

TSOP-5 CASE 483-02 ISSUE M

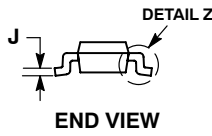
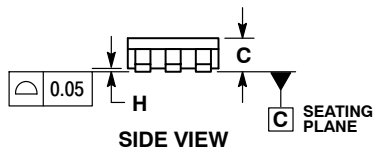
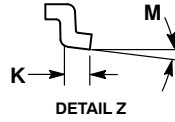
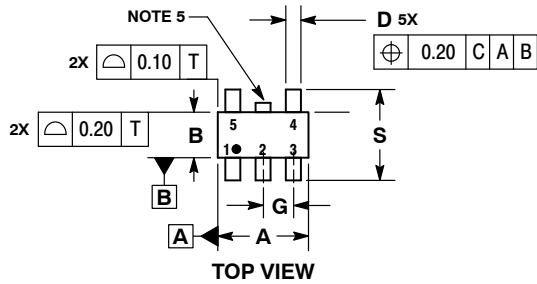

NOTES:

1. DIMENSIONING AND TOLERANCING PER ASME Y14.5M, 1994.
2. CONTROLLING DIMENSION: MILLIMETERS.
3. MAXIMUM LEAD THICKNESS INCLUDES LEAD FINISH THICKNESS. MINIMUM LEAD THICKNESS IS THE MINIMUM THICKNESS OF BASE MATERIAL.
4. DIMENSIONS A AND B DO NOT INCLUDE MOLD FLASH, PROTRUSIONS, OR GATE BURRS. MOLD FLASH, PROTRUSIONS, OR GATE BURRS SHALL NOT EXCEED 0.15 PER SIDE. DIMENSION A.
5. OPTIONAL CONSTRUCTION: AN ADDITIONAL TRIMMED LEAD IS ALLOWED IN THIS LOCATION. TRIMMED LEAD NOT TO EXTEND MORE THAN 0.2 FROM BODY.

DIM	MILLIMETERS	
	MIN	MAX
A	2.85	3.15
B	1.35	1.65
C	0.90	1.10
D	0.25	0.50
G	0.95 BSC	
H	0.01	0.10
J	0.10	0.26
K	0.20	0.60
M	0°	10°
S	2.50	3.00

SOLDERING FOOTPRINT*

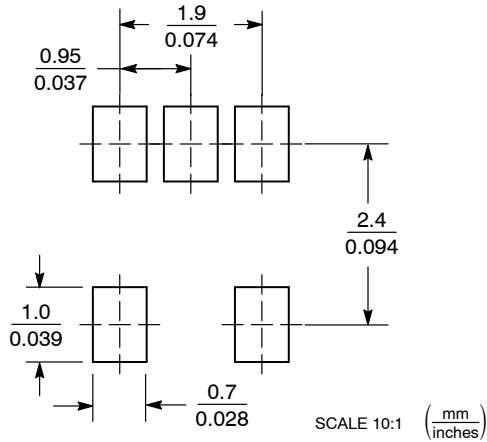

*For additional information on our Pb-Free strategy and soldering details, please download the ON Semiconductor Soldering and Mounting Techniques Reference Manual, SOLDERRM/D.

LMV321, NCV321, LMV358, LMV324

PACKAGE DIMENSIONS

Micro8 CASE 846A-02 ISSUE J

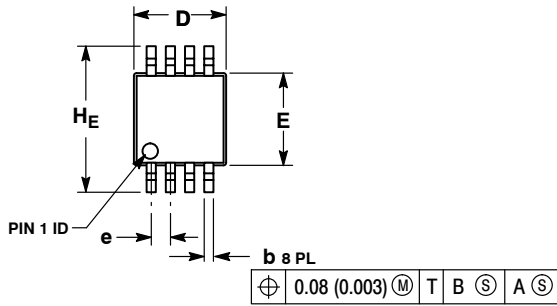

NOTES:

1. DIMENSIONING AND TOLERANCING PER ANSI Y14.5M, 1982.
2. CONTROLLING DIMENSION: MILLIMETER.
3. DIMENSION A DOES NOT INCLUDE MOLD FLASH, PROTRUSIONS OR GATE BURRS. MOLD FLASH, PROTRUSIONS OR GATE BURRS SHALL NOT EXCEED 0.15 (0.006) PER SIDE.
4. DIMENSION B DOES NOT INCLUDE INTERLEAD FLASH OR PROTRUSION. INTERLEAD FLASH OR PROTRUSION SHALL NOT EXCEED 0.25 (0.010) PER SIDE.
5. 846A-01 OBSOLETE, NEW STANDARD 846A-02.

DIM	MILLIMETERS			INCHES		
	MIN	NOM	MAX	MIN	NOM	MAX
A	--	--	1.10	--	--	0.043
A1	0.05	0.08	0.15	0.002	0.003	0.006
b	0.25	0.33	0.40	0.010	0.013	0.016
c	0.13	0.18	0.23	0.005	0.007	0.009
D	2.90	3.00	3.10	0.114	0.118	0.122
E	2.90	3.00	3.10	0.114	0.118	0.122
e	0.65 BSC			0.026 BSC		
L	0.40	0.55	0.70	0.016	0.021	0.028
HE	4.75	4.90	5.05	0.187	0.193	0.199

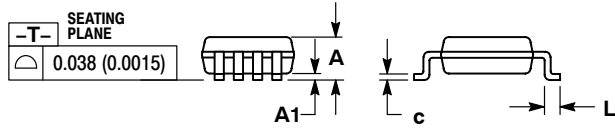

RECOMMENDED SOLDERING FOOTPRINT*

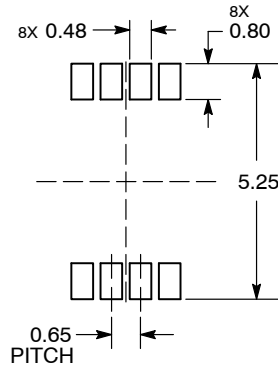

DIMENSION: MILLIMETERS

*For additional information on our Pb-Free strategy and soldering details, please download the ON Semiconductor Soldering and Mounting Techniques Reference Manual, SOLDERRM/D.

LMV321, NCV321, LMV358, LMV324

PACKAGE DIMENSIONS

UDFN8 1.8x1.2, 0.4P
CASE 517AJ
ISSUE O

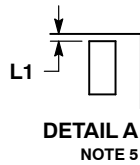
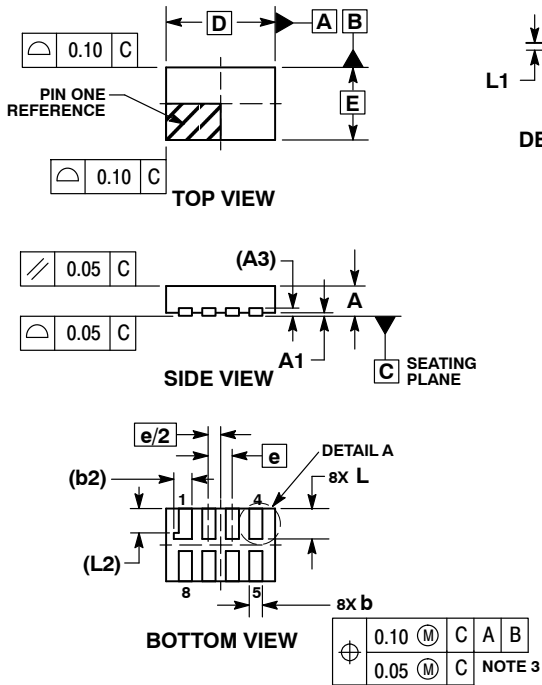

NOTES:

1. DIMENSIONING AND TOLERANCING PER ASME Y14.5M, 1994.
2. CONTROLLING DIMENSION: MILLIMETERS.
3. DIMENSION b APPLIES TO PLATED TERMINAL AND IS MEASURED BETWEEN 0.15 AND 0.30 mm FROM TERMINAL TIP.
4. MOLD FLASH ALLOWED ON TERMINALS ALONG EDGE OF PACKAGE. FLASH MAY NOT EXCEED 0.03 ONTO BOTTOM SURFACE OF TERMINALS.
5. DETAIL A SHOWS OPTIONAL CONSTRUCTION FOR TERMINALS.

MILLIMETERS		
DIM	MIN	MAX
A	0.45	0.55
A1	0.00	0.05
A3	0.127	REF
b	0.15	0.25
b2	0.30	REF
D	1.80	BSC
E	1.20	BSC
e	0.40	BSC
L	0.45	0.55
L1	0.00	0.03
L2	0.40	REF

**MOUNTING FOOTPRINT*
SOLDEMASK DEFINED**

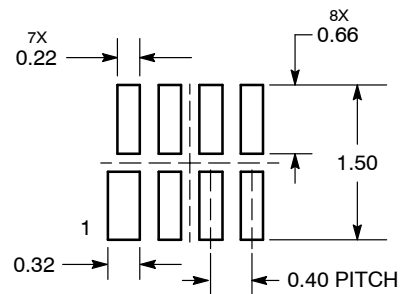

DIMENSIONS: MILLIMETERS

*For additional information on our Pb-Free strategy and soldering details, please download the ON Semiconductor Soldering and Mounting Techniques Reference Manual, SOLDERRM/D.

LMV321, NCV321, LMV358, LMV324

PACKAGE DIMENSIONS

SOIC-8 NB
CASE 751-07
ISSUE AK

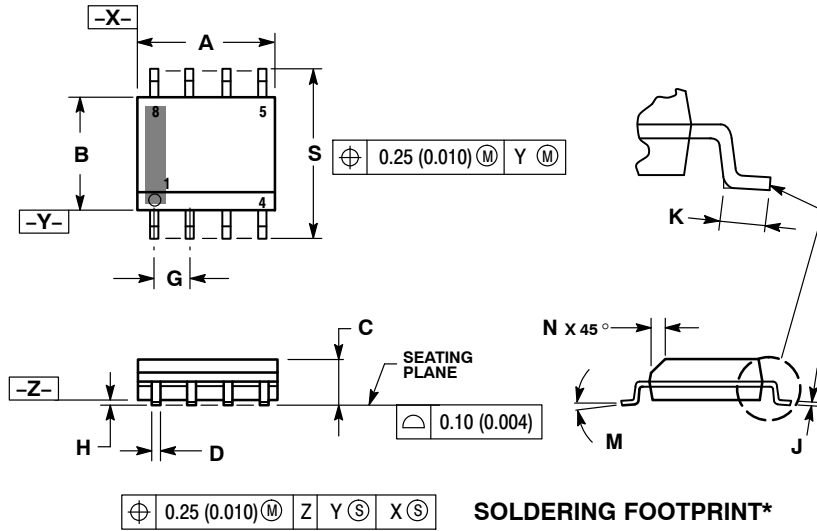

- NOTES:
1. DIMENSIONING AND TOLERANCING PER ANSI Y14.5M, 1982.
 2. CONTROLLING DIMENSION: MILLIMETER.
 3. DIMENSION A AND B DO NOT INCLUDE MOLD PROTRUSION.
 4. MAXIMUM MOLD PROTRUSION 0.15 (0.006) PER SIDE.
 5. DIMENSION D DOES NOT INCLUDE DAMBAR PROTRUSION. ALLOWABLE DAMBAR PROTRUSION SHALL BE 0.127 (0.005) TOTAL IN EXCESS OF THE D DIMENSION AT MAXIMUM MATERIAL CONDITION.
 6. 751-01 THRU 751-06 ARE OBSOLETE. NEW STANDARD IS 751-07.

DIM	MILLIMETERS		INCHES	
	MIN	MAX	MIN	MAX
A	4.80	5.00	0.189	0.197
B	3.80	4.00	0.150	0.157
C	1.35	1.75	0.053	0.069
D	0.33	0.51	0.013	0.020
G	1.27 BSC		0.050 BSC	
H	0.10	0.25	0.004	0.010
J	0.19	0.25	0.007	0.010
K	0.40	1.27	0.016	0.050
M	0°	8°	0°	8°
N	0.25	0.50	0.010	0.020
S	5.80	6.20	0.228	0.244

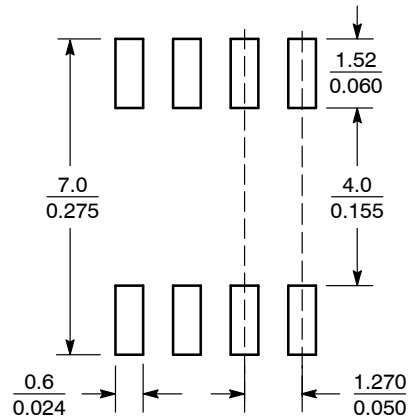

SCALE 6:1 $\left(\frac{\text{mm}}{\text{inches}}\right)$

*For additional information on our Pb-Free strategy and soldering details, please download the ON Semiconductor Soldering and Mounting Techniques Reference Manual, SOLDERRM/D.

LMV321, NCV321, LMV358, LMV324

PACKAGE DIMENSIONS

SOIC-14 NB
CASE 751A-03
ISSUE L

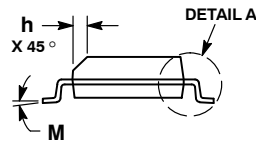
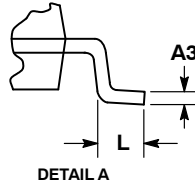
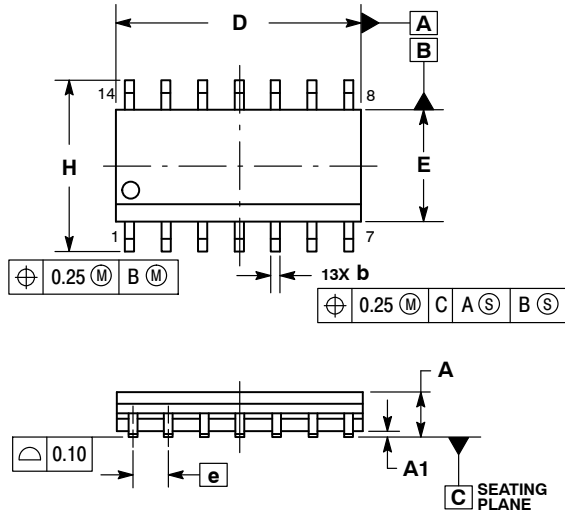

NOTES:

1. DIMENSIONING AND TOLERANCING PER ASME Y14.5M, 1994.
2. CONTROLLING DIMENSION: MILLIMETERS.
3. DIMENSION b DOES NOT INCLUDE DAMBAR PROTRUSION. ALLOWABLE PROTRUSION SHALL BE 0.13 TOTAL IN EXCESS OF AT MAXIMUM MATERIAL CONDITION.
4. DIMENSIONS D AND E DO NOT INCLUDE MOLD PROTRUSIONS.
5. MAXIMUM MOLD PROTRUSION 0.15 PER SIDE.

DIM	MILLIMETERS		INCHES	
	MIN	MAX	MIN	MAX
A	1.35	1.75	0.054	0.068
A1	0.10	0.25	0.004	0.010
A3	0.19	0.25	0.008	0.010
b	0.35	0.49	0.014	0.019
D	8.55	8.75	0.337	0.344
E	3.80	4.00	0.150	0.157
e	1.27 BSC		0.050 BSC	
H	5.80	6.20	0.228	0.244
h	0.25	0.50	0.010	0.019
L	0.40	1.25	0.016	0.049
M	0°	7°	0°	7°

SOLDERING FOOTPRINT*

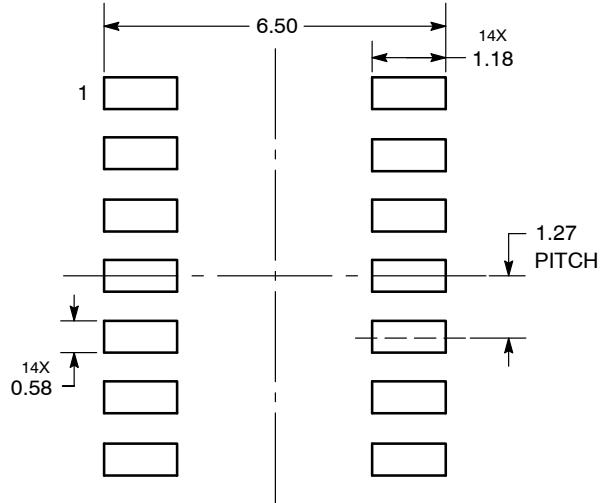

DIMENSIONS: MILLIMETERS

*For additional information on our Pb-Free strategy and soldering details, please download the ON Semiconductor Soldering and Mounting Techniques Reference Manual, SOLDERRM/D.

LMV321, NCV321, LMV358, LMV324

PACKAGE DIMENSIONS

TSSOP-14
CASE 948G
ISSUE C

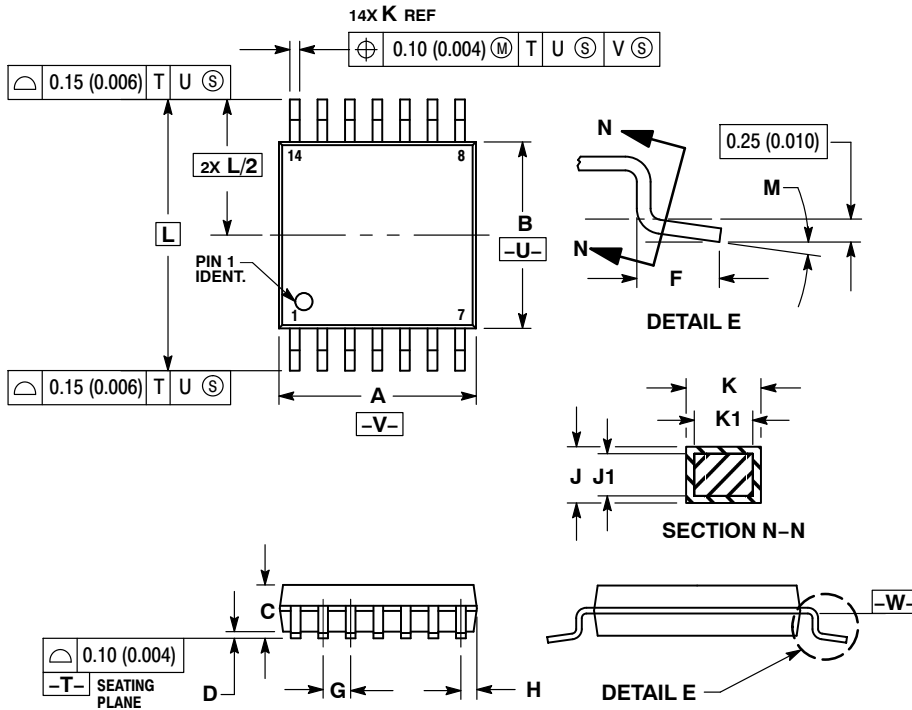

NOTES:

1. DIMENSIONING AND TOLERANCING PER ANSI Y14.5M, 1982.
2. CONTROLLING DIMENSION: MILLIMETER.
3. DIMENSION A DOES NOT INCLUDE MOLD FLASH, PROTRUSIONS OR GATE BURRS. MOLD FLASH OR GATE BURRS SHALL NOT EXCEED 0.15 (0.006) PER SIDE.
4. DIMENSION B DOES NOT INCLUDE INTERLEAD FLASH OR PROTRUSION. INTERLEAD FLASH OR PROTRUSION SHALL NOT EXCEED 0.25 (0.010) PER SIDE.
5. DIMENSION K DOES NOT INCLUDE DAMBAR PROTRUSION. ALLOWABLE DAMBAR PROTRUSION SHALL BE 0.08 (0.003) TOTAL IN EXCESS OF THE K DIMENSION AT MAXIMUM MATERIAL CONDITION.
6. TERMINAL NUMBERS ARE SHOWN FOR REFERENCE ONLY.
7. DIMENSION A AND B ARE TO BE DETERMINED AT DATUM PLANE -W-.

DIM	MILLIMETERS		INCHES	
	MIN	MAX	MIN	MAX
A	4.90	5.10	0.193	0.200
B	4.30	4.50	0.169	0.177
C	---	1.20	---	0.047
D	0.05	0.15	0.002	0.006
F	0.50	0.75	0.020	0.030
G	0.65 BSC		0.026 BSC	
H	0.50	0.60	0.020	0.024
J	0.09	0.20	0.004	0.008
J1	0.09	0.16	0.004	0.006
K	0.19	0.30	0.007	0.012
K1	0.19	0.25	0.007	0.010
L	6.40 BSC		0.252 BSC	
M	0°	8°	0°	8°

SOLDERING FOOTPRINT*

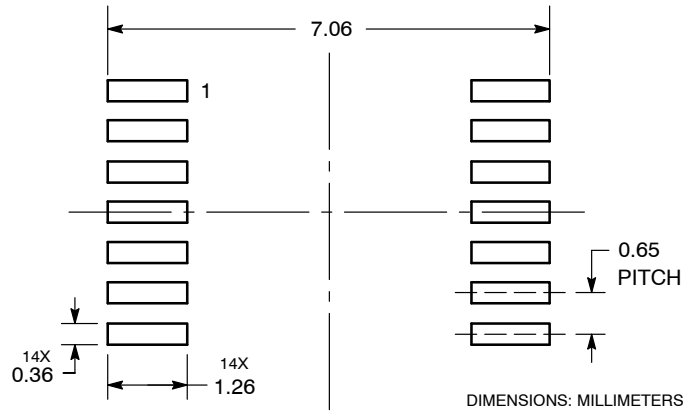

*For additional information on our Pb-Free strategy and soldering details, please download the ON Semiconductor Soldering and Mounting Techniques Reference Manual, SOLDERRM/D.

LMV321, NCV321, LMV358, LMV324

ON Semiconductor and  are trademarks of Semiconductor Components Industries, LLC dba ON Semiconductor or its subsidiaries in the United States and/or other countries. ON Semiconductor owns the rights to a number of patents, trademarks, copyrights, trade secrets, and other intellectual property. A listing of ON Semiconductor's product/patent coverage may be accessed at www.onsemi.com/site/pdf/Patent-Marking.pdf. ON Semiconductor reserves the right to make changes without further notice to any products herein. ON Semiconductor makes no warranty, representation or guarantee regarding the suitability of its products for any particular purpose, nor does ON Semiconductor assume any liability arising out of the application or use of any product or circuit, and specifically disclaims any and all liability, including without limitation special, consequential or incidental damages. Buyer is responsible for its products and applications using ON Semiconductor products, including compliance with all laws, regulations and safety requirements or standards, regardless of any support or applications information provided by ON Semiconductor. "Typical" parameters which may be provided in ON Semiconductor data sheets and/or specifications can and do vary in different applications and actual performance may vary over time. All operating parameters, including "Typicals" must be validated for each customer application by customer's technical experts. ON Semiconductor does not convey any license under its patent rights nor the rights of others. ON Semiconductor products are not designed, intended, or authorized for use as a critical component in life support systems or any FDA Class 3 medical devices or medical devices with a same or similar classification in a foreign jurisdiction or any devices intended for implantation in the human body. Should Buyer purchase or use ON Semiconductor products for any such unintended or unauthorized application, Buyer shall indemnify and hold ON Semiconductor and its officers, employees, subsidiaries, affiliates, and distributors harmless against all claims, costs, damages, and expenses, and reasonable attorney fees arising out of, directly or indirectly, any claim of personal injury or death associated with such unintended or unauthorized use, even if such claim alleges that ON Semiconductor was negligent regarding the design or manufacture of the part. ON Semiconductor is an Equal Opportunity/Affirmative Action Employer. This literature is subject to all applicable copyright laws and is not for resale in any manner.

PUBLICATION ORDERING INFORMATION

LITERATURE FULFILLMENT:

Literature Distribution Center for ON Semiconductor
19521 E. 32nd Pkwy, Aurora, Colorado 80011 USA
Phone: 303-675-2175 or 800-344-3860 Toll Free USA/Canada
Fax: 303-675-2176 or 800-344-3867 Toll Free USA/Canada
Email: orderlit@onsemi.com

N. American Technical Support: 800-282-9855 Toll Free
USA/Canada
Europe, Middle East and Africa Technical Support:
Phone: 421 33 790 2910

ON Semiconductor Website: www.onsemi.com

Order Literature: <http://www.onsemi.com/orderlit>

For additional information, please contact your local
Sales Representative

Looking for pricing, stock, or lifecycle information?

Click below to explore more details on WIN SOURCE:

 [View LMV321SQ3T2G on WIN SOURCE](#)

 [ON Semiconductor](#) Information

Optimize Your Supply Chain with WIN SOURCE Solutions

-  Global Sourcing Solution
-  Obsolete Management
-  Cost Control Management
-  Shortage Management
-  Alternative Solution
-  Excess Inventory Management