



# THE DATASHEET OF LMV358IDRG4



## LMV3xx Low-Voltage Rail-to-Rail Output Operational Amplifiers

### 1 Features

- 2.7-V and 5-V Performance
- –40°C to 125°C Operation
- Low-Power Shutdown Mode (LMV324S)
- No Crossover Distortion
- Low Supply Current
  - LMV321: 130  $\mu$ A Typ
  - LMV358: 210  $\mu$ A Typ
  - LMV324: 410  $\mu$ A Typ
  - LMV324S: 410  $\mu$ A Typ
- Rail-to-Rail Output Swing
- ESD Protection Exceeds JESD 22
  - 2000-V Human-Body Model
  - 1000-V Charged-Device Model

### 2 Applications

- Desktop PCs
- HVAC: Heating, Ventilating, and Air Conditioning
- Motor Control: AC Induction
- Netbooks
- Portable Media Players
- Power: Telecom DC/DC Module: Digital
- Pro Audio Mixers
- Refrigerators
- Washing Machines: High-End and Low-End

### 4 Simplified Schematic



### 3 Description

The LMV321, LMV358, LMV324, and LMV324S devices are single, dual, and quad low-voltage (2.7 V to 5.5 V) operational amplifiers with rail-to-rail output swing. These devices are the most cost-effective solutions for applications where low-voltage operation, space saving, and low cost are needed. These amplifiers are designed specifically for low-voltage (2.7 V to 5 V) operation, with performance specifications meeting or exceeding the LM358 and LM324 devices that operate from 5 V to 30 V. With package sizes down to one-half the size of the DBV (SOT-23) package, these devices can be used for a variety of applications.

#### Device Information(1)

PART NUMBER	PACKAGE (PIN)	BODY SIZE
LMV324	SOIC (14)	8.65 mm x 3.91 mm
LMV321	SOT-23 (5)	2.90 mm x 1.60 mm
	SC-70 (5)	2.00 mm x 1.25 mm
LMV358	VSSOP (8)	2.30 mm x 2.00 mm
	VSSOP (8)	3.00 mm x 3.00 mm
	TSSOP (8)	3.00 mm x 4.40 mm

(1) For all available packages, see the orderable addendum at the end of the datasheet.



## Table of Contents

<b>1 Features</b> .....	<b>1</b>	8.1 Overview .....	<b>16</b>
<b>2 Applications</b> .....	<b>1</b>	8.2 Functional Block Diagram .....	<b>16</b>
<b>3 Description</b> .....	<b>1</b>	8.3 Feature Description .....	<b>17</b>
<b>4 Simplified Schematic</b> .....	<b>1</b>	8.4 Device Functional Modes .....	<b>17</b>
<b>5 Revision History</b> .....	<b>2</b>	<b>9 Application and Implementation</b> .....	<b>18</b>
<b>6 Pin Configuration and Functions</b> .....	<b>3</b>	9.1 Typical Application .....	<b>18</b>
<b>7 Specifications</b> .....	<b>4</b>	<b>10 Power Supply Recommendations</b> .....	<b>21</b>
7.1 Absolute Maximum Ratings .....	<b>4</b>	<b>11 Layout</b> .....	<b>22</b>
7.2 Handling Ratings .....	<b>4</b>	11.1 Layout Guidelines .....	<b>22</b>
7.3 Recommended Operating Conditions .....	<b>4</b>	11.2 Layout Example .....	<b>22</b>
7.4 Thermal Information .....	<b>4</b>	<b>12 Device and Documentation Support</b> .....	<b>23</b>
7.5 Electrical Characteristics: $V_{CC+} = 2.7\text{ V}$ .....	<b>5</b>	12.1 Related Links .....	<b>23</b>
7.6 Electrical Characteristics: $V_{CC+} = 5\text{ V}$ .....	<b>6</b>	12.2 Trademarks .....	<b>23</b>
7.7 Shutdown Characteristics, LMV324S: $V_{CC+} = 2.7\text{ V}$ .....	<b>7</b>	12.3 Electrostatic Discharge Caution .....	<b>23</b>
7.8 Shutdown Characteristics, LMV324S: $V_{CC+} = 5\text{ V}$ ...	<b>7</b>	12.4 Glossary .....	<b>23</b>
7.9 Typical Characteristics .....	<b>8</b>	<b>13 Mechanical, Packaging, and Orderable Information</b> .....	<b>23</b>
<b>8 Detailed Description</b> .....	<b>16</b>		

## 5 Revision History

### Changes from Revision V (December 2013) to Revision W

**Page**

- Added Applications, Handling Rating table, Thermal Information Table, Device Functional Modes, Application and Implementation section, Power Supply Recommendations section, Layout section, Device and Documentation Support section, and Mechanical, Packaging, and Orderable Information section. .... **1**

### Changes from Revision U (July 2012) to Revision V

**Page**

- Updated document to new TI data sheet format. .... **1**
- Removed Ordering Information table. .... **3**
- Added ESD warning. .... **23**

## 6 Pin Configuration and Functions

LMV358 . . . D (SOIC), DDU (VSSOP),  
DGK (VSSOP), OR PW (TSSOP) PACKAGE  
(TOP VIEW)

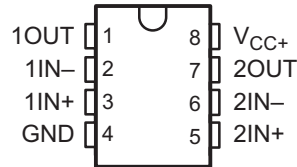

LMV321 . . . DBV (SOT-23)  
OR DCK (SC-70) PACKAGE  
(TOP VIEW)

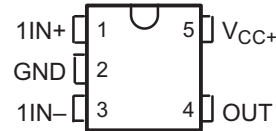

LMV324 . . . D (SOIC) OR PW (TSSOP) PACKAGE  
(TOP VIEW)

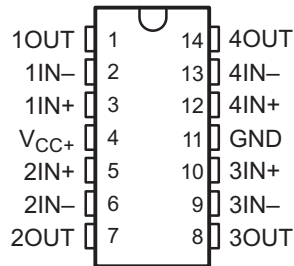

LMV324S . . . D (SOIC) OR PW (TSSOP) PACKAGE  
(TOP VIEW)



### Pin Functions

NAME	PIN				TYPE	DESCRIPTION
	LMV358 D, DDU, DGK, PW	LMV321 DBV or DCK	LMV324 D or PW	LMV324S D or PW		
3/4 SHDN	—	—	—	9	I	Shutdown (logic low)/enable (logic high)
1/2 SHDN	—	—	—	8	I	Shutdown (logic low)/enable (logic high)
1IN+	3	1	3	3	I	Noninverting input
1IN-	2	3	2	2	I	Inverting input
2IN+	5	—	5	5	I	Noninverting input
2IN-	6	—	6	6	I	Inverting input
2OUT	7	—	7	7	O	Output
3IN+	—	—	10	12	I	Noninverting input
3IN-	—	—	9	11	I	Inverting input
3OUT	—	—	8	10	O	Output
4IN+	—	—	12	14	I	Noninverting input
4IN-	—	—	13	15	I	Inverting input
4OUT	—	—	14	16	O	Output
GND	4	2	11	13	-	Negative supply
OUT	1	4	1	1	O	OUT
VCC+	8	5	4	4	-	Positive supply

## 7 Specifications

### 7.1 Absolute Maximum Ratings

 over operating free-air temperature range (unless otherwise noted) <sup>(1)</sup>

		MIN	MAX	UNIT
V <sub>CC</sub>	Supply voltage <sup>(2)</sup>		5.5	V
V <sub>ID</sub>	Differential input voltage <sup>(3)</sup>		±5.5	V
V <sub>I</sub>	Input voltage range (either input)	-0.2	5.7	V
	Duration of output short circuit (one amplifier) to ground <sup>(4)</sup>	At or below T <sub>A</sub> = 25°C, V <sub>CC</sub> ≤ 5.5 V		Unlimited
T <sub>J</sub>	Operating virtual junction temperature		150	°C

- (1) Stresses beyond those listed under *Absolute Maximum Ratings* may cause permanent damage to the device. These are stress ratings only, and functional operation of the device at these or any other conditions beyond those indicated under *Recommended Operating Conditions* is not implied. Exposure to absolute-maximum-rated conditions for extended periods may affect device reliability.
- (2) All voltage values (except differential voltages and V<sub>CC</sub> specified for the measurement of I<sub>OS</sub>) are with respect to the network GND.
- (3) Differential voltages are at IN+ with respect to IN-.
- (4) Short circuits from outputs to V<sub>CC</sub> can cause excessive heating and eventual destruction.

### 7.2 Handling Ratings

		MIN	MAX	UNIT	
T <sub>stg</sub>	Storage temperature range	-65	150	°C	
V <sub>(ESD)</sub>	Electrostatic discharge	Human body model (HBM), per ANSI/ESDA/JEDEC JS-001, all pins <sup>(1)</sup>	0	2500	V
		Charged device model (CDM), per JEDEC specification JESD22-C101, all pins <sup>(2)</sup>	0	1500	

- (1) JEDEC document JEP155 states that 500-V HBM allows safe manufacturing with a standard ESD control process.
- (2) JEDEC document JEP157 states that 250-V CDM allows safe manufacturing with a standard ESD control process.

### 7.3 Recommended Operating Conditions<sup>(1)</sup>

		MIN	MAX	UNIT	
V <sub>CC</sub>	Supply voltage (single-supply operation)	2.7	5.5	V	
V <sub>IH</sub>	Amplifier turn-on voltage level (LMV324S) <sup>(2)</sup>	V <sub>CC</sub> = 2.7 V	1.7	V	
		V <sub>CC</sub> = 5 V	3.5		
V <sub>IL</sub>	Amplifier turn-off voltage level (LMV324S)	V <sub>CC</sub> = 2.7 V	0.7	V	
		V <sub>CC</sub> = 5 V	1.5		
T <sub>A</sub>	Operating free-air temperature	I temperature (LMV321, LMV358, LMV324, LMV321IDCK)	-40	125	°C
		I temperature (LMV324S)	-40	85	
		Q temperature	-40	125	

- (1) All unused control inputs of the device must be held at V<sub>CC</sub> or GND to ensure proper device operation. See the TI application report, *Implications of Slow or Floating CMOS Inputs*, literature number [SCBA004](#).
- (2) V<sub>IH</sub> should not be allowed to exceed V<sub>CC</sub>.

### 7.4 Thermal Information

THERMAL METRIC <sup>(1)</sup>	LMV3xx										UNIT	
	D			DBV	DCK	DDU	DGK	PW				
	8 PIN	14 PIN	16 PIN	5 PIN	5 PIN	8 PIN	8 PIN	8 PIN	14 PIN	16 PIN		
R <sub>θJA</sub>	Junction-to-ambient thermal resistance	97	86	73	206	252	210	172	149	113	108	°C/W

- (1) For more information about traditional and new thermal metrics, see the *IC Package Thermal Metrics* application report, [SPRA953](#).

## 7.5 Electrical Characteristics: $V_{CC+} = 2.7\text{ V}$

 $V_{CC+} = 2.7\text{ V}$ ,  $T_A = 25^\circ\text{C}$  (unless otherwise noted)

PARAMETER		TEST CONDITIONS		MIN	TYP <sup>(1)</sup>	MAX	UNIT
$V_{IO}$	Input offset voltage				1.7	7	mV
$\alpha_{VIO}$	Average temperature coefficient of input offset voltage				5		$\mu\text{V}/^\circ\text{C}$
$I_{IB}$	Input bias current				11	250	nA
$I_{IO}$	Input offset current				5	50	nA
CMRR	Common-mode rejection ratio	$V_{CM} = 0\text{ to }1.7\text{ V}$		50	63		dB
$k_{SVR}$	Supply-voltage rejection ratio	$V_{CC} = 2.7\text{ V to }5\text{ V}$ , $V_O = 1\text{ V}$		50	60		dB
$V_{ICR}$	Common-mode input voltage range	CMRR $\geq 50\text{ dB}$		0	-0.2		V
					1.9	1.7	
$V_O$	Output swing	$R_L = 10\text{ k}\Omega\text{ to }1.35\text{ V}$	High level	$V_{CC} - 100$	$V_{CC} - 10$		mV
			Low level		60	180	
$I_{CC}$	Supply current	LMV321I			80	170	$\mu\text{A}$
		LMV358I (both amplifiers)			140	340	
		LMV324I and LMV324SI (all four amplifiers)			260	680	
$B_1$	Unity-gain bandwidth	$C_L = 200\text{ pF}$			1		MHz
$\Phi_m$	Phase margin				60		deg
$G_m$	Gain margin				10		dB
$V_n$	Equivalent input noise voltage	$f = 1\text{ kHz}$			46		$\text{nV}/\sqrt{\text{Hz}}$
$I_n$	Equivalent input noise current	$f = 1\text{ kHz}$			0.17		$\text{pA}/\sqrt{\text{Hz}}$

- (1) Typical values represent the likely parametric nominal values determined at the time of characterization. Typical values depend on the application and configuration and may vary over time. Typical values are not ensured on production material.

## 7.6 Electrical Characteristics: $V_{CC+} = 5\text{ V}$

 $V_{CC+} = 5\text{ V}$ , at specified free-air temperature (unless otherwise noted)

PARAMETER		TEST CONDITIONS		$T_A$ <sup>(1)</sup>	MIN	TYP <sup>(2)</sup>	MAX	UNIT
$V_{IO}$	Input offset voltage			25°C		1.7	7	mV
				Full range			9	
$\alpha_{VIO}$	Average temperature coefficient of input offset voltage			25°C		5		$\mu\text{V}/^\circ\text{C}$
$I_{IB}$	Input bias current			25°C		15	250	nA
				Full range			500	
$I_{IO}$	Input offset current			25°C		5	50	nA
				Full range			150	
CMRR	Common-mode rejection ratio	$V_{CM} = 0$ to 4 V		25°C	50	65		dB
$k_{SVR}$	Supply-voltage rejection ratio	$V_{CC} = 2.7\text{ V}$ to 5 V, $V_O = 1\text{ V}$ , $V_{CM} = 1\text{ V}$		25°C	50	60		dB
$V_{ICR}$	Common-mode input voltage range	CMRR $\geq 50\text{ dB}$		25°C	0	-0.2		V
						4.2	4	
$V_O$	Output swing	$R_L = 2\text{ k}\Omega$ to 2.5 V	High level	25°C	$V_{CC} - 300$	$V_{CC} - 40$		mV
				Full range	$V_{CC} - 400$			
			Low level	25°C		120	300	
				Full range			400	
		$R_L = 10\text{ k}\Omega$ to 2.5 V	High level	25°C	$V_{CC} - 100$	$V_{CC} - 10$		
				Full range	$V_{CC} - 200$			
			Low level	25°C		65	180	
				Full range			280	
$A_{VD}$	Large-signal differential voltage gain	$R_L = 2\text{ k}\Omega$		25°C	15	100	V/mV	
				Full range	10			
$I_{OS}$	Output short-circuit current	Sourcing, $V_O = 0\text{ V}$		25°C	5	60	mA	
		Sinking, $V_O = 5\text{ V}$			10	160		
$I_{CC}$	Supply current	LMV321I		25°C		130	250	$\mu\text{A}$
				Full range			350	
		LMV358I (both amplifiers)		25°C		210	440	
				Full range			615	
		LMV324I and LMV324SI (all four amplifiers)		25°C		410	830	
				Full range			1160	
$B_1$	Unity-gain bandwidth	$C_L = 200\text{ pF}$		25°C		1	MHz	
$\Phi_m$	Phase margin			25°C		60	deg	
$G_m$	Gain margin			25°C		10	dB	
$V_n$	Equivalent input noise voltage	$f = 1\text{ kHz}$		25°C		39	$\text{nV}/\sqrt{\text{Hz}}$	
$I_n$	Equivalent input noise current	$f = 1\text{ kHz}$		25°C		0.21	$\text{pA}/\sqrt{\text{Hz}}$	
SR	Slew rate			25°C		1	$\text{V}/\mu\text{s}$	

(1) Full range  $T_A = -40^\circ\text{C}$  to  $125^\circ\text{C}$  for I temperature (LMV321, LMV358, LMV324, LMV321IDCK),  $-40^\circ\text{C}$  to  $85^\circ\text{C}$  for (LMV324S) and  $-40^\circ\text{C}$  to  $125^\circ\text{C}$  for Q temperature.

(2) Typical values represent the likely parametric nominal values determined at the time of characterization. Typical values depend on the application and configuration and may vary over time. Typical values are not ensured on production material.

### 7.7 Shutdown Characteristics, LMV324S: $V_{CC+} = 2.7\text{ V}$

 $V_{CC+} = 2.7\text{ V}$ ,  $T_A = 25^\circ\text{C}$  (unless otherwise noted)

PARAMETER		TEST CONDITIONS	MIN	TYP <sup>(1)</sup>	MAX	UNIT
$I_{CC(\text{SHDN})}$	Supply current in shutdown mode (per channel)	$\overline{\text{SHDN}} \leq 0.6\text{ V}$			5	$\mu\text{A}$
$t_{(\text{on})}$	Amplifier turn-on time	$A_V = 1$ , $R_L = \text{Open}$ (measured at 50% point)		2		$\mu\text{s}$
$t_{(\text{off})}$	Amplifier turn-off time	$A_V = 1$ , $R_L = \text{Open}$ (measured at 50% point)		40		ns

(1) Typical values represent the likely parametric nominal values determined at the time of characterization. Typical values depend on the application and configuration and may vary over time. Typical values are not ensured on production material.

### 7.8 Shutdown Characteristics, LMV324S: $V_{CC+} = 5\text{ V}$

 $V_{CC+} = 5\text{ V}$ ,  $T_A = 25^\circ\text{C}$  (unless otherwise noted)

PARAMETER		TEST CONDITIONS	MIN	TYP <sup>(1)</sup>	MAX	UNIT
$I_{CC(\text{SHDN})}$	Supply current in shutdown mode (per channel)	$\overline{\text{SHDN}} \leq 0.6\text{ V}$ , $T_A = \text{Full Temperature Range}$			5	$\mu\text{A}$
$t_{(\text{on})}$	Amplifier turn-on time	$A_V = 1$ , $R_L = \text{Open}$ (measured at 50% point)		2		$\mu\text{s}$
$t_{(\text{off})}$	Amplifier turn-off time	$A_V = 1$ , $R_L = \text{Open}$ (measured at 50% point)		40		ns

(1) Typical values represent the likely parametric nominal values determined at the time of characterization. Typical values depend on the application and configuration and may vary over time. Typical values are not ensured on production material.

## 7.9 Typical Characteristics

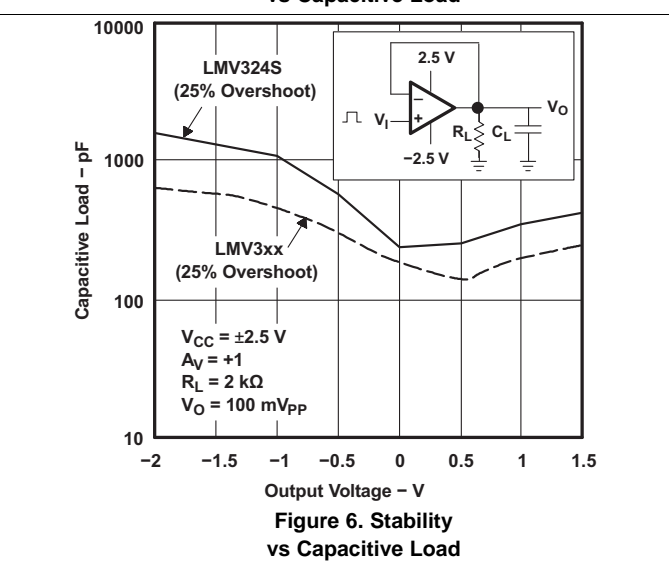
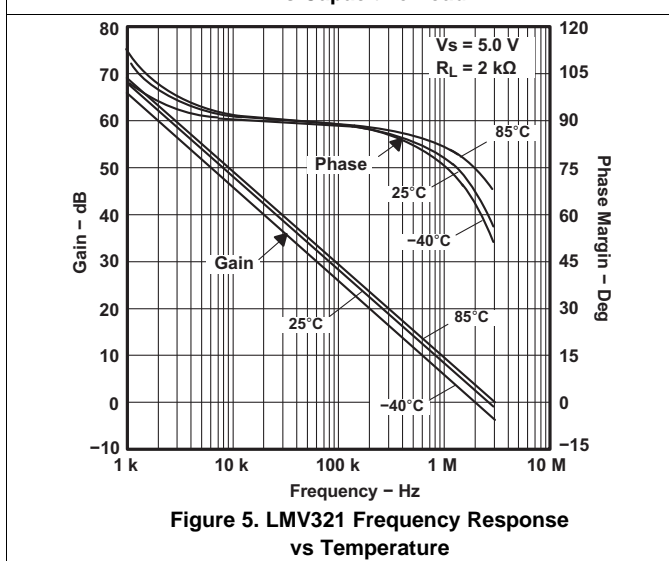
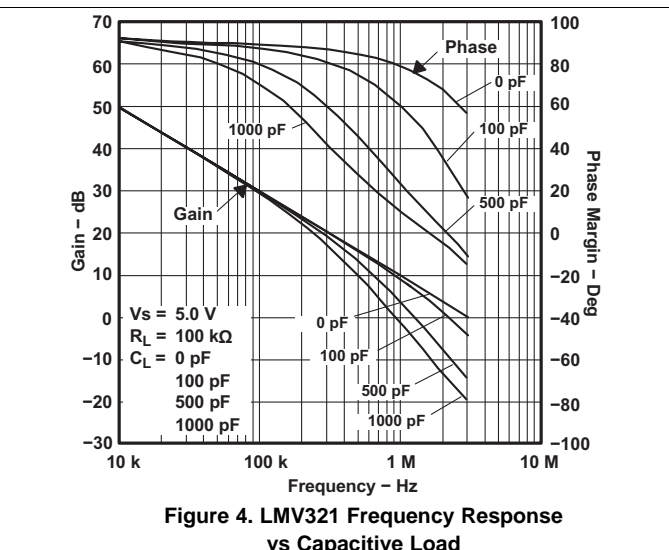
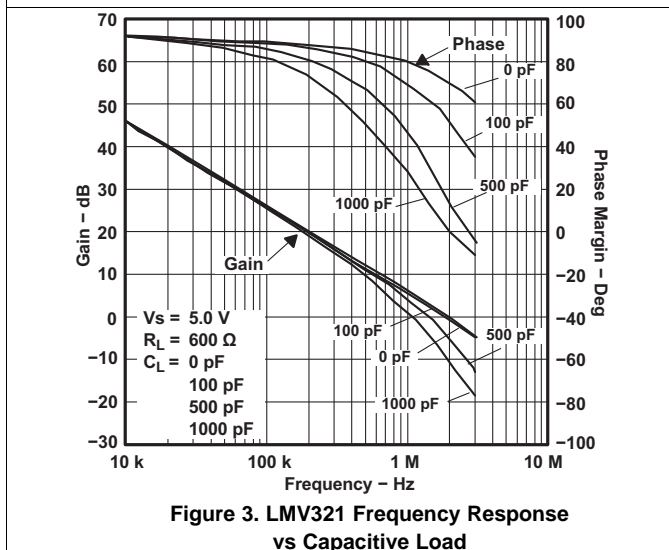

Typical Characteristics (continued)

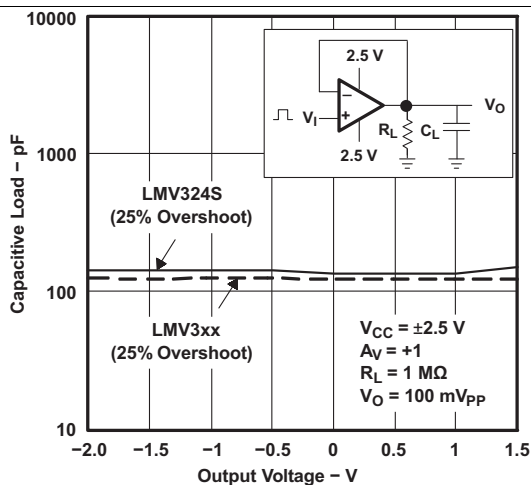

Figure 7. Stability vs Capacitive Load

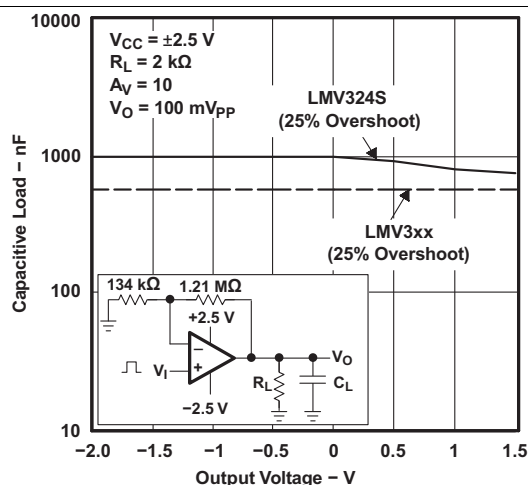

Figure 8. Stability vs Capacitive Load

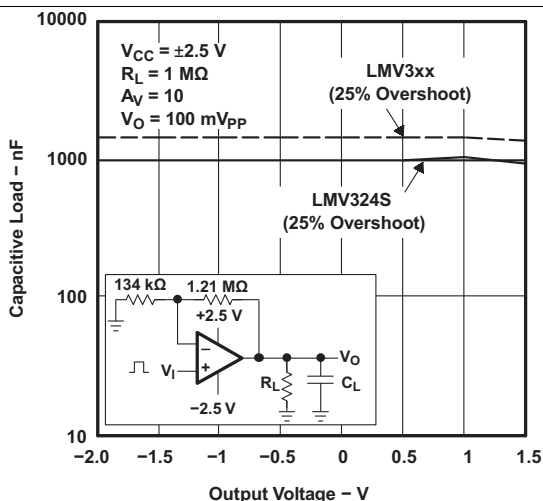

Figure 9. Stability vs Capacitive Load

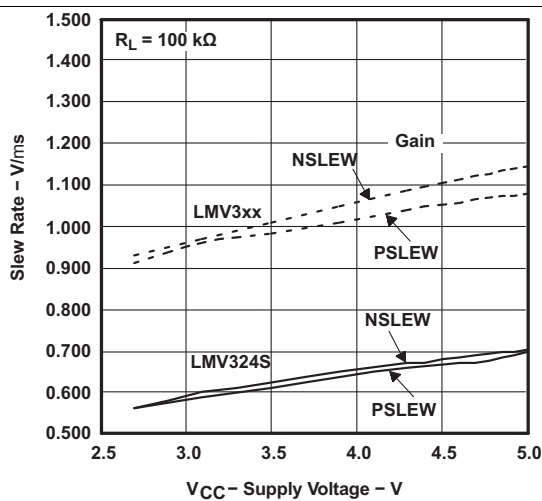

Figure 10. Slew Rate vs Supply Voltage

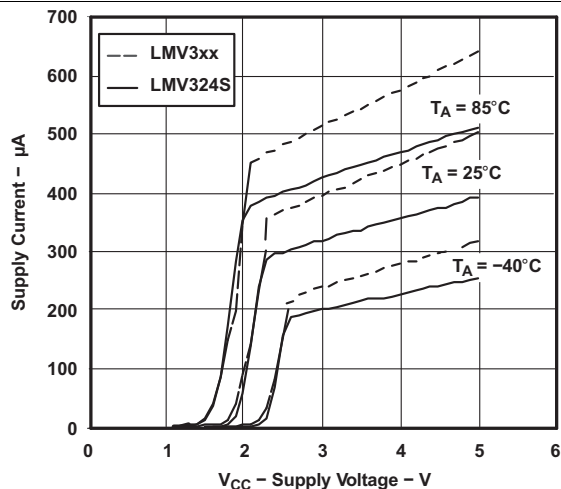

Figure 11. Supply Current vs Supply Voltage - Quad Amplifier

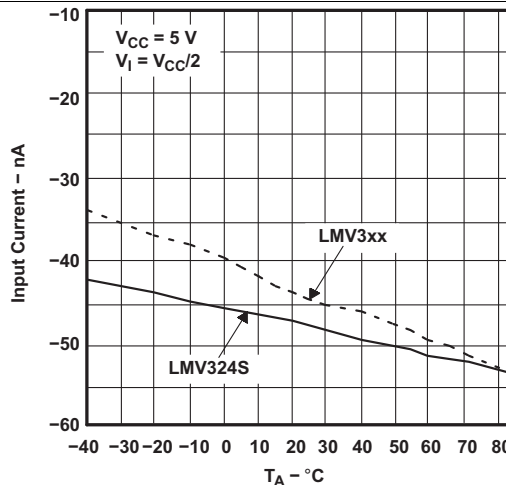

Figure 12. Input Current vs Temperature

Typical Characteristics (continued)



Figure 13. Source Current vs Output Voltage



Figure 14. Source Current vs Output Voltage

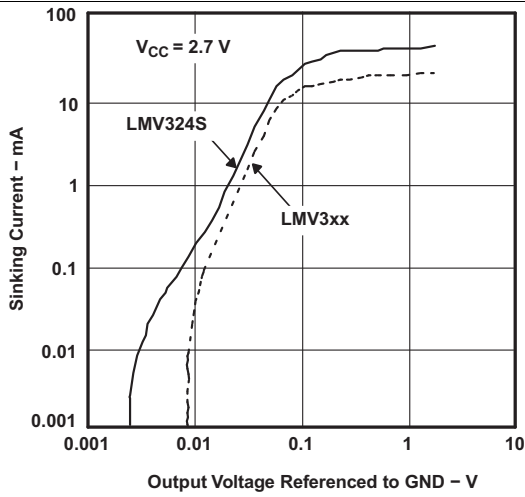

Figure 15. Sinking Current vs Output Voltage



Figure 16. Sinking Current vs Output Voltage

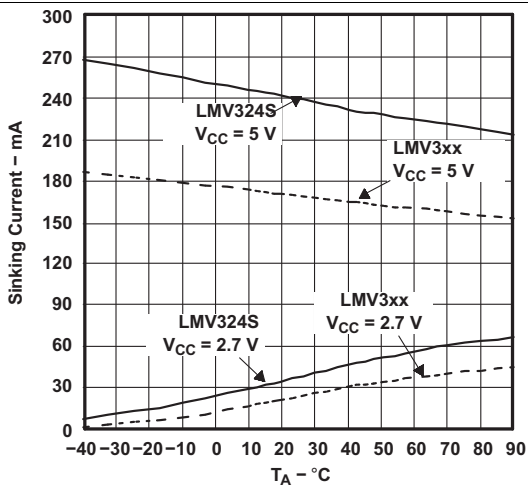

Figure 17. Short-Circuit Current vs Temperature

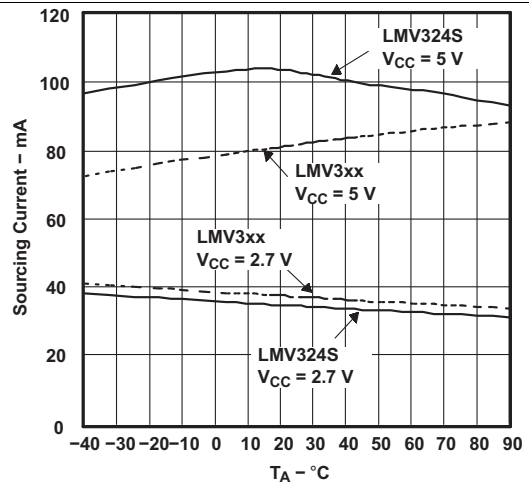

Figure 18. Short-Circuit Current vs Temperature

Typical Characteristics (continued)

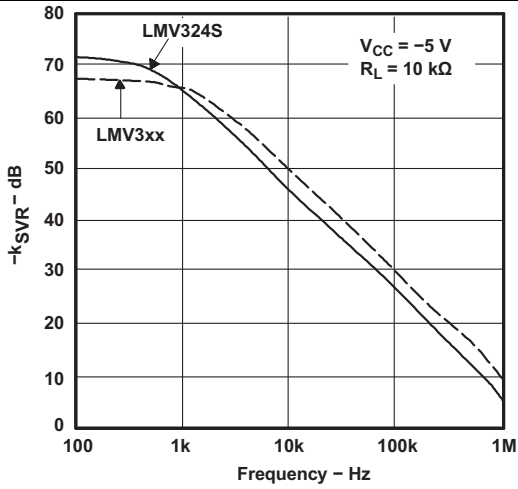

Figure 19.  $-k_{SVR}$  vs Frequency

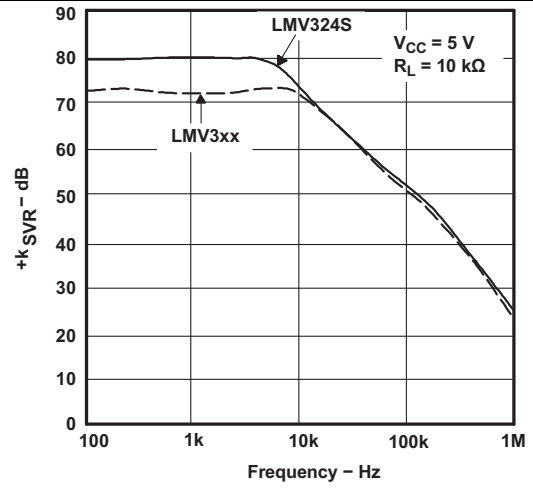

Figure 20.  $+k_{SVR}$  vs Frequency

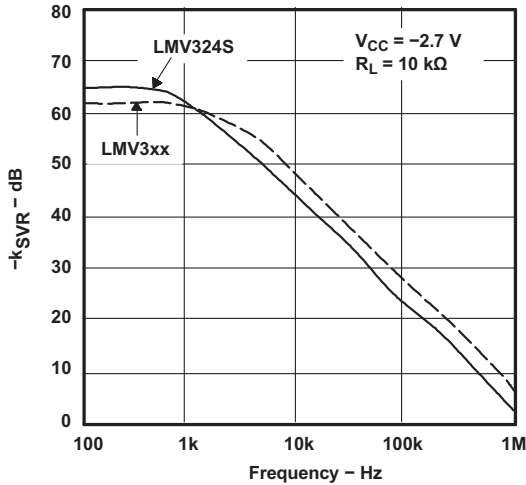

Figure 21.  $-k_{SVR}$  vs Frequency

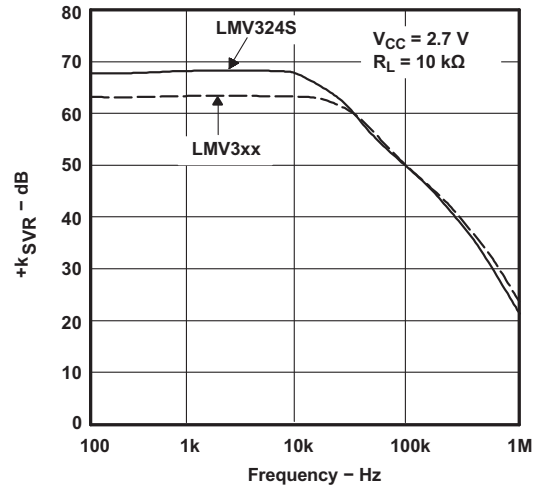

Figure 22.  $+k_{SVR}$  vs Frequency

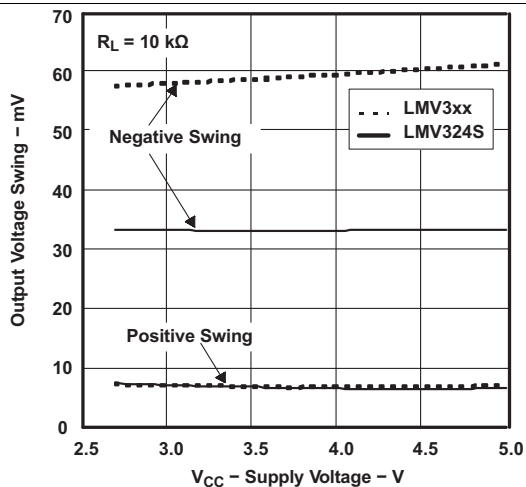

Figure 23. Output Voltage Swing From Rails vs Supply Voltage

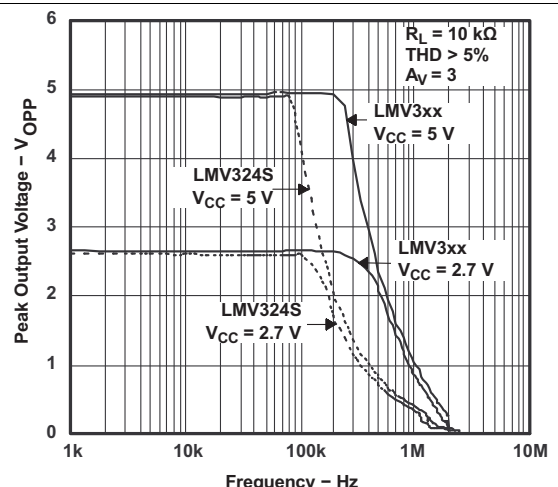

Figure 24. Output Voltage vs Frequency

Typical Characteristics (continued)



Figure 25. Open-Loop Output Impedance vs Frequency

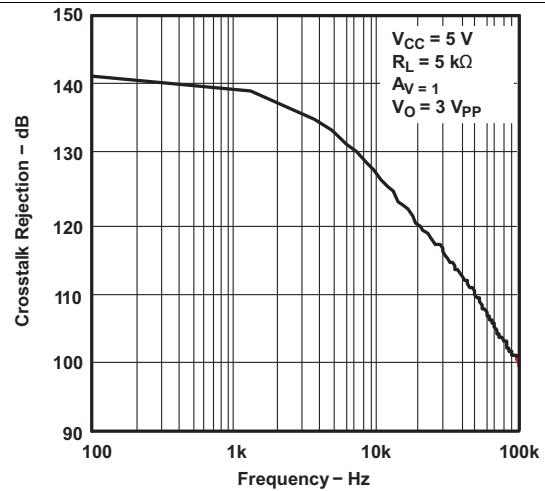

Figure 26. Cross-Talk Rejection vs Frequency



Figure 27. Noninverting Large-Signal Pulse Response



Figure 28. Noninverting Large-Signal Pulse Response

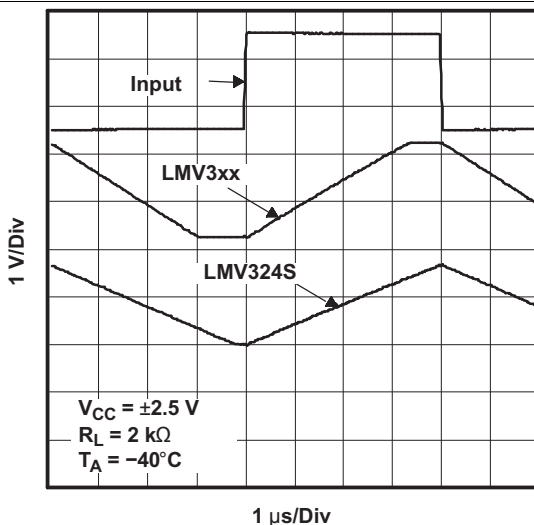

Figure 29. Noninverting Large-Signal Pulse Response

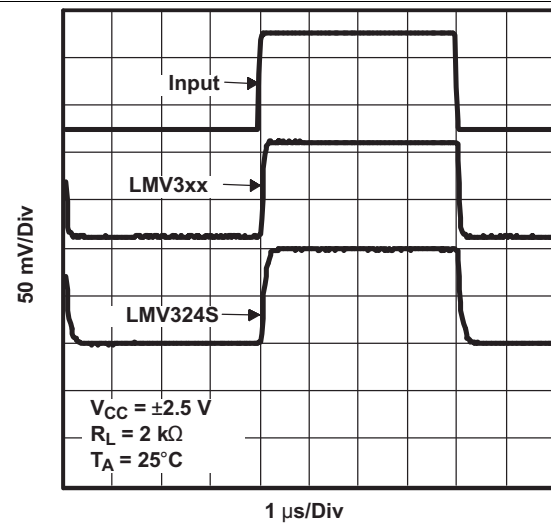

Figure 30. Noninverting Small-Signal Pulse Response

Typical Characteristics (continued)



Figure 31. Noninverting Small-Signal Pulse Response

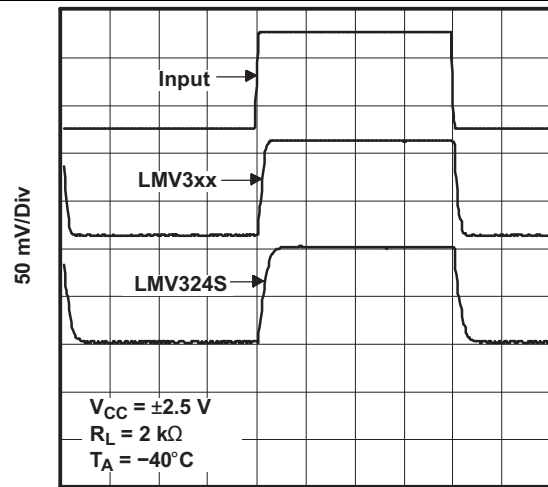

Figure 32. Noninverting Small-Signal Pulse Response



Figure 33. Inverting Large-Signal Pulse Response

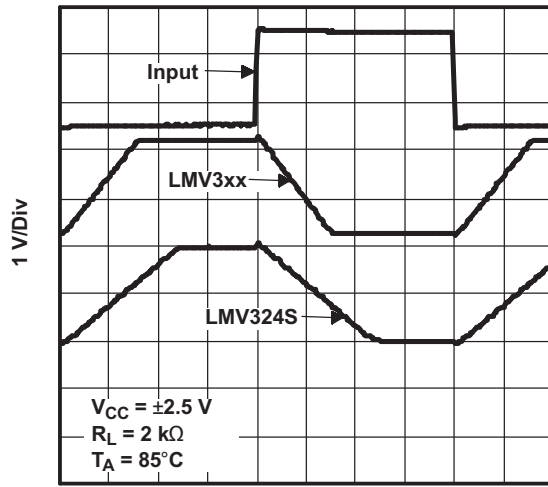

Figure 34. Inverting Large-Signal Pulse Response



Figure 35. Inverting Large-Signal Pulse Response

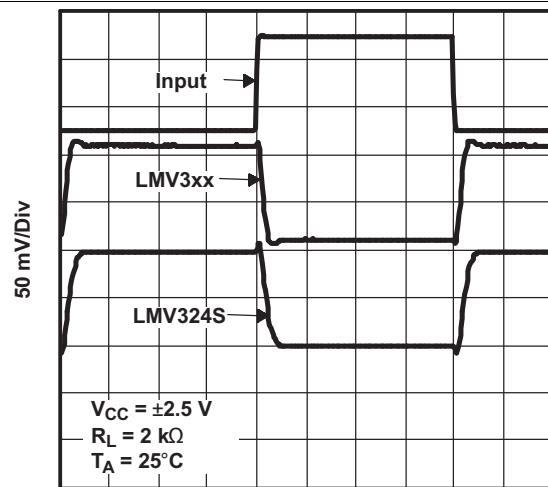

Figure 36. Inverting Small-Signal Pulse Response

Typical Characteristics (continued)



Figure 37. Inverting Small-Signal Pulse Response



Figure 38. Inverting Small-Signal Pulse Response

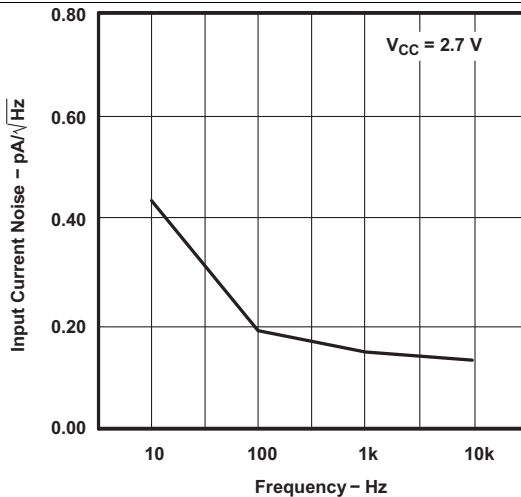

Figure 39. Input Current Noise vs Frequency

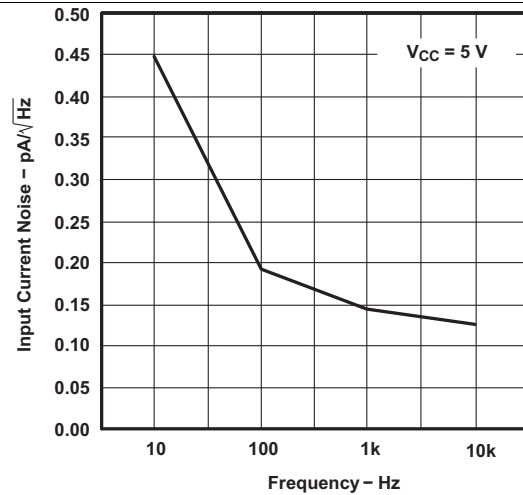

Figure 40. Input Current Noise vs Frequency



Figure 41. Input Voltage Noise vs Frequency

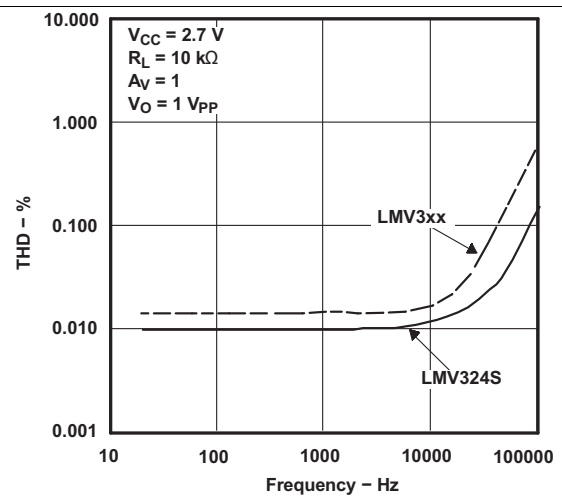

Figure 42. THD + N vs Frequency

Typical Characteristics (continued)

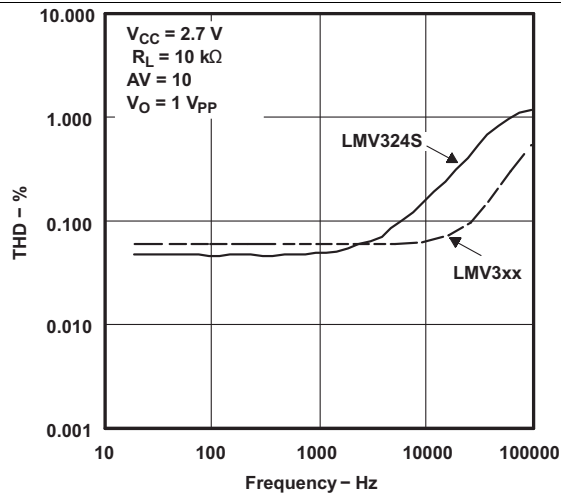

Figure 43. THD + N vs Frequency

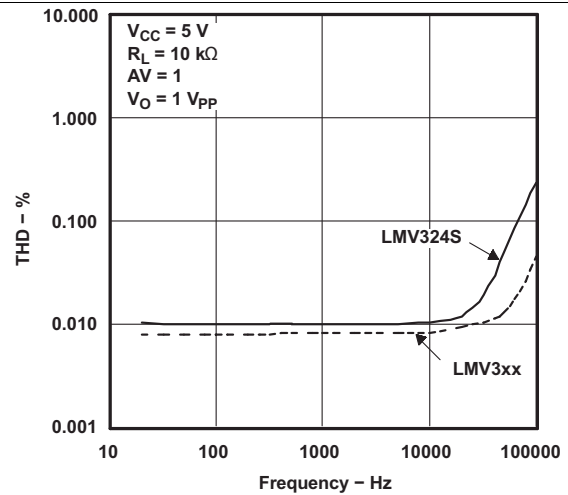

Figure 44. THD + N vs Frequency

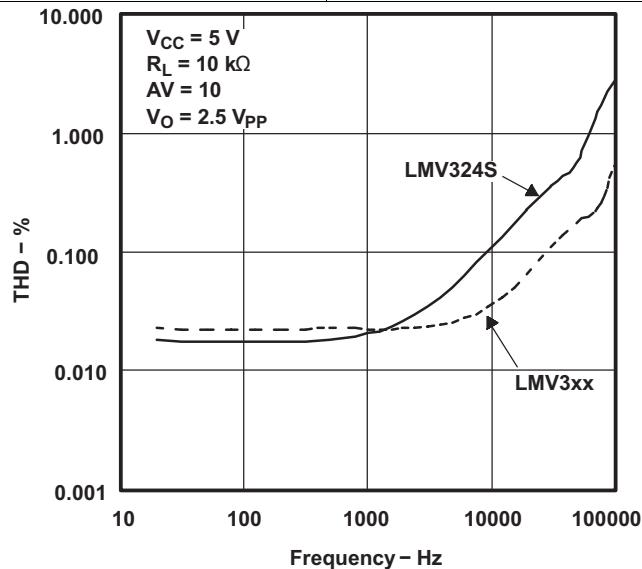

Figure 45. THD + N vs Frequency



## 8.3 Feature Description

### 8.3.1 Operating Voltage

The LMV321, LMV358, LMV324, LMV324S devices are fully specified and ensured for operation from 2.7 V to 5 V. In addition, many specifications apply from  $-40^{\circ}\text{C}$  to  $125^{\circ}\text{C}$ . Parameters that vary significantly with operating voltages or temperature are shown in the [Typical Characteristics](#) graphs.

### 8.3.2 Unity-Gain Bandwidth

The unity-gain bandwidth is the frequency up to which an amplifier with a unity gain may be operated without greatly distorting the signal. The LMV321, LMV358, LMV324, LMV324S devices have a 1-MHz unity-gain bandwidth.

### 8.3.3 Slew Rate

The slew rate is the rate at which an operational amplifier can change its output when there is a change on the input. The LMV321, LMV358, LMV324, LMV324S devices have a 1-V/ $\mu\text{s}$  slew rate.

## 8.4 Device Functional Modes

The LMV321, LMV358, LMV324, LMV324S devices are powered on when the supply is connected. The LMV324S device, which is a variation of the standard LMV324 device, includes a power-saving shutdown feature that reduces supply current to a maximum of 5  $\mu\text{A}$  per channel when the amplifiers are not needed. Each of these devices can be operated as a single supply operational amplifier or dual supply amplifier depending on the application.

## 9 Application and Implementation

### NOTE

Information in the following applications sections is not part of the TI component specification, and TI does not warrant its accuracy or completeness. TI's customers are responsible for determining suitability of components for their purposes. Customers should validate and test their design implementation to confirm system functionality.

### 9.1 Typical Application

Some applications require differential signals. [Figure 46](#) shows a simple circuit to convert a single-ended input of 0.5 to 2 V into differential output of  $\pm 1.5$  V on a single 2.7-V supply. The output range is intentionally limited to maximize linearity. The circuit is composed of two amplifiers. One amplifier acts as a buffer and creates a voltage,  $V_{OUT+}$ . The second amplifier inverts the input and adds a reference voltage to generate  $V_{OUT-}$ . Both  $V_{OUT+}$  and  $V_{OUT-}$  range from 0.5 to 2 V. The difference,  $V_{DIFF}$ , is the difference between  $V_{OUT+}$  and  $V_{OUT-}$ . The LMV358 was used to build this circuit.



**Figure 46. Schematic for Single-Ended Input to Differential Output Conversion**

## Typical Application (continued)

### 9.1.1 Design Requirements

The design requirements are as follows:

- Supply voltage: 2.7 V
- Reference voltage: 2.5 V
- Input: 0.5 to 2 V
- Output differential:  $\pm 1.5$  V

### 9.1.2 Detailed Design Procedure

The circuit in [Figure 46](#) takes a single-ended input signal,  $V_{IN}$ , and generates two output signals,  $V_{OUT+}$  and  $V_{OUT-}$  using two amplifiers and a reference voltage,  $V_{REF}$ .  $V_{OUT+}$  is the output of the first amplifier and is a buffered version of the input signal,  $V_{IN}$  (see [Equation 1](#)).  $V_{OUT-}$  is the output of the second amplifier which uses  $V_{REF}$  to add an offset voltage to  $V_{IN}$  and feedback to add inverting gain. The transfer function for  $V_{OUT-}$  is [Equation 2](#).

$$V_{OUT+} = V_{IN} \quad (1)$$

$$V_{OUT-} = V_{REF} \times \left( \frac{R_4}{R_3 + R_4} \right) \times \left( 1 + \frac{R_2}{R_1} \right) - V_{IN} \times \frac{R_2}{R_1} \quad (2)$$

The differential output signal,  $V_{DIFF}$ , is the difference between the two single-ended output signals,  $V_{OUT+}$  and  $V_{OUT-}$ . [Equation 3](#) shows the transfer function for  $V_{DIFF}$ . By applying the conditions that  $R_1 = R_2$  and  $R_3 = R_4$ , the transfer function is simplified into [Equation 6](#). Using this configuration, the maximum input signal is equal to the reference voltage and the maximum output of each amplifier is equal to the  $V_{REF}$ . The differential output range is  $2 \times V_{REF}$ . Furthermore, the common mode voltage will be one half of  $V_{REF}$  (see [Equation 7](#)).

$$V_{DIFF} = V_{OUT+} - V_{OUT-} = V_{IN} \times \left( 1 + \frac{R_2}{R_1} \right) - V_{REF} \times \left( \frac{R_4}{R_3 + R_4} \right) \left( 1 + \frac{R_2}{R_1} \right) \quad (3)$$

$$V_{OUT+} = V_{IN} \quad (4)$$

$$V_{OUT-} = V_{REF} - V_{IN} \quad (5)$$

$$V_{DIFF} = 2 \times V_{IN} - V_{REF} \quad (6)$$

$$V_{cm} = \left( \frac{V_{OUT+} + V_{OUT-}}{2} \right) = \frac{1}{2} V_{REF} \quad (7)$$

#### 9.1.2.1 Amplifier Selection

Linearity over the input range is key for good dc accuracy. The common mode input range and the output swing limitations determine the linearity. In general, an amplifier with rail-to-rail input and output swing is required. Bandwidth is a key concern for this design. Because LMV358 has a bandwidth of 1 MHz, this circuit will only be able to process signals with frequencies of less than 1 MHz.

#### 9.1.2.2 Passive Component Selection

Because the transfer function of  $V_{OUT-}$  is heavily reliant on resistors ( $R_1$ ,  $R_2$ ,  $R_3$ , and  $R_4$ ), use resistors with low tolerances to maximize performance and minimize error. This design used resistors with resistance values of 36 k $\Omega$  with tolerances measured to be within 2%. If the noise of the system is a key parameter, the user can select smaller resistance values (6 k $\Omega$  or lower) to keep the overall system noise low. This ensures that the noise from the resistors is lower than the amplifier noise.

## Typical Application (continued)

### 9.1.3 Application Curves

The measured transfer functions in [Figure 47](#), [Figure 48](#), and [Figure 49](#) were generated by sweeping the input voltage from 0 V to 2.5 V. However, this design should only be used between 0.5 V and 2 V for optimum linearity.

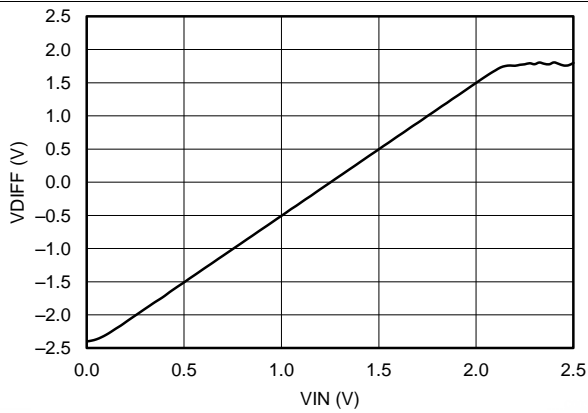

Figure 47. Differential Output Voltage vs Input Voltage

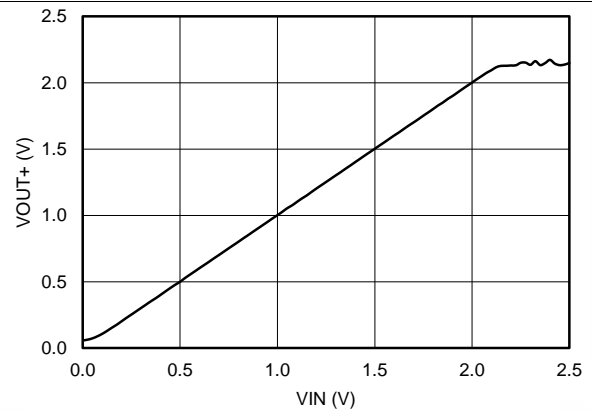

Figure 48. Positive Output Voltage Node vs Input Voltage



Figure 49. Positive Output Voltage Node vs Input Voltage

## 10 Power Supply Recommendations

The LMV321, LMV358, LMV324, LMV324S devices are specified for operation from 2.7 to 5 V; many specifications apply from  $-40^{\circ}\text{C}$  to  $125^{\circ}\text{C}$ . The [Typical Characteristics](#) section presents parameters that can exhibit significant variance with regard to operating voltage or temperature.

### CAUTION

Supply voltages larger than 5.5 V can permanently damage the device (see the [Absolute Maximum Ratings](#)).

Place 0.1- $\mu\text{F}$  bypass capacitors close to the power-supply pins to reduce errors coupling in from noisy or high impedance power supplies. For more detailed information on bypass capacitor placement, refer to the [Layout](#).

## 11 Layout

### 11.1 Layout Guidelines

For best operational performance of the device, use good PCB layout practices, including:

- Noise can propagate into analog circuitry through the power pins of the circuit as a whole, as well as the operational amplifier. Bypass capacitors are used to reduce the coupled noise by providing low impedance power sources local to the analog circuitry.
  - Connect low-ESR, 0.1- $\mu$ F ceramic bypass capacitors between each supply pin and ground, placed as close to the device as possible. A single bypass capacitor from V+ to ground is applicable for single supply applications.
- Separate grounding for analog and digital portions of circuitry is one of the simplest and most-effective methods of noise suppression. One or more layers on multilayer PCBs are usually devoted to ground planes. A ground plane helps distribute heat and reduces EMI noise pickup. Make sure to physically separate digital and analog grounds, paying attention to the flow of the ground current. For more detailed information, refer to *Circuit Board Layout Techniques*, (SLOA089).
- To reduce parasitic coupling, run the input traces as far away from the supply or output traces as possible. If it is not possible to keep them separate, it is much better to cross the sensitive trace perpendicular as opposed to in parallel with the noisy trace.
- Place the external components as close to the device as possible. Keeping RF and RG close to the inverting input minimizes parasitic capacitance, as shown in *Layout Example*.
- Keep the length of input traces as short as possible. Always remember that the input traces are the most sensitive part of the circuit.
- Consider a driven, low-impedance guard ring around the critical traces. A guard ring can significantly reduce leakage currents from nearby traces that are at different potentials.

### 11.2 Layout Example



**Figure 50. Operational Amplifier Schematic for Noninverting Configuration**



**Figure 51. Operational Amplifier Board Layout for Noninverting Configuration**

## 12 Device and Documentation Support

### 12.1 Related Links

The table below lists quick access links. Categories include technical documents, support and community resources, tools and software, and quick access to sample or buy.

**Table 1. Related Links**

PARTS	PRODUCT FOLDER	SAMPLE & BUY	TECHNICAL DOCUMENTS	TOOLS & SOFTWARE	SUPPORT & COMMUNITY
LMV321	<a href="#">Click here</a>	<a href="#">Click here</a>	<a href="#">Click here</a>	<a href="#">Click here</a>	<a href="#">Click here</a>
LMV358	<a href="#">Click here</a>	<a href="#">Click here</a>	<a href="#">Click here</a>	<a href="#">Click here</a>	<a href="#">Click here</a>
LMV324	<a href="#">Click here</a>	<a href="#">Click here</a>	<a href="#">Click here</a>	<a href="#">Click here</a>	<a href="#">Click here</a>
LMV324S	<a href="#">Click here</a>	<a href="#">Click here</a>	<a href="#">Click here</a>	<a href="#">Click here</a>	<a href="#">Click here</a>

### 12.2 Trademarks

All trademarks are the property of their respective owners.

### 12.3 Electrostatic Discharge Caution



These devices have limited built-in ESD protection. The leads should be shorted together or the device placed in conductive foam during storage or handling to prevent electrostatic damage to the MOS gates.

### 12.4 Glossary

[SLYZ022](#) — *TI Glossary*.

This glossary lists and explains terms, acronyms and definitions.

## 13 Mechanical, Packaging, and Orderable Information

The following pages include mechanical packaging and orderable information. This information is the most current data available for the designated devices. This data is subject to change without notice and revision of this document. For browser based versions of this data sheet, refer to the left hand navigation.

**PACKAGING INFORMATION**

Orderable Device	Status (1)	Package Type	Package Drawing	Pins	Package Qty	Eco Plan (2)	Lead/Ball Finish (6)	MSL Peak Temp (3)	Op Temp (°C)	Device Marking (4/5)	Samples
LMV321IDBVR	ACTIVE	SOT-23	DBV	5	3000	Green (RoHS & no Sb/Br)	CU NIPDAU	Level-1-260C-UNLIM	-40 to 125	(RC1F, RC1K)	<a href="#">Samples</a>
LMV321IDBvre4	ACTIVE	SOT-23	DBV	5	3000	Green (RoHS & no Sb/Br)	CU NIPDAU	Level-1-260C-UNLIM	-40 to 125	(RC1F, RC1K)	<a href="#">Samples</a>
LMV321IDBVRG4	ACTIVE	SOT-23	DBV	5	3000	Green (RoHS & no Sb/Br)	CU NIPDAU	Level-1-260C-UNLIM	-40 to 125	(RC1F, RC1K)	<a href="#">Samples</a>
LMV321IDBVT	ACTIVE	SOT-23	DBV	5	250	Green (RoHS & no Sb/Br)	CU NIPDAU	Level-1-260C-UNLIM	-40 to 125	(RC1F, RC1K)	<a href="#">Samples</a>
LMV321IDBvTE4	ACTIVE	SOT-23	DBV	5	250	Green (RoHS & no Sb/Br)	CU NIPDAU	Level-1-260C-UNLIM	-40 to 125	(RC1F, RC1K)	<a href="#">Samples</a>
LMV321IDCKR	ACTIVE	SC70	DCK	5	3000	Green (RoHS & no Sb/Br)	CU NIPDAU   CU NIPDAUAG	Level-1-260C-UNLIM	-40 to 125	(R3F, R3K, R3O, R3 R, R3Z)	<a href="#">Samples</a>
LMV321IDCKRG4	ACTIVE	SC70	DCK	5	3000	Green (RoHS & no Sb/Br)	CU NIPDAU	Level-1-260C-UNLIM	-40 to 125	(R3F, R3K, R3O, R3 R, R3Z)	<a href="#">Samples</a>
LMV321IDCKT	ACTIVE	SC70	DCK	5	250	Green (RoHS & no Sb/Br)	CU NIPDAU   CU NIPDAUAG	Level-1-260C-UNLIM	-40 to 125	(R3C, R3F, R3R)	<a href="#">Samples</a>
LMV324ID	ACTIVE	SOIC	D	14	50	Green (RoHS & no Sb/Br)	CU NIPDAU	Level-1-260C-UNLIM	-40 to 125	LMV324I	<a href="#">Samples</a>
LMV324IDR	ACTIVE	SOIC	D	14	2500	Green (RoHS & no Sb/Br)	CU NIPDAU   CU SN	Level-1-260C-UNLIM	-40 to 125	LMV324I	<a href="#">Samples</a>
LMV324IDRE4	ACTIVE	SOIC	D	14	2500	Green (RoHS & no Sb/Br)	CU NIPDAU	Level-1-260C-UNLIM	-40 to 125	LMV324I	<a href="#">Samples</a>
LMV324IDRG4	ACTIVE	SOIC	D	14	2500	Green (RoHS & no Sb/Br)	CU NIPDAU	Level-1-260C-UNLIM	-40 to 125	LMV324I	<a href="#">Samples</a>
LMV324IPWR	ACTIVE	TSSOP	PW	14	2000	Green (RoHS & no Sb/Br)	CU NIPDAU   CU SN	Level-1-260C-UNLIM	-40 to 125	MV324I	<a href="#">Samples</a>
LMV324IPWRE4	ACTIVE	TSSOP	PW	14	2000	Green (RoHS & no Sb/Br)	CU NIPDAU	Level-1-260C-UNLIM	-40 to 125	MV324I	<a href="#">Samples</a>
LMV324IPWRG4	ACTIVE	TSSOP	PW	14	2000	Green (RoHS & no Sb/Br)	CU NIPDAU	Level-1-260C-UNLIM	-40 to 125	MV324I	<a href="#">Samples</a>
LMV324QD	ACTIVE	SOIC	D	14	50	Green (RoHS & no Sb/Br)	CU NIPDAU	Level-1-260C-UNLIM	-40 to 125	LMV324Q	<a href="#">Samples</a>
LMV324QDG4	ACTIVE	SOIC	D	14	50	Green (RoHS & no Sb/Br)	CU NIPDAU	Level-1-260C-UNLIM	-40 to 125	LMV324Q	<a href="#">Samples</a>

Orderable Device	Status (1)	Package Type	Package Drawing	Pins	Package Qty	Eco Plan (2)	Lead/Ball Finish (6)	MSL Peak Temp (3)	Op Temp (°C)	Device Marking (4/5)	Samples
LMV324QDR	ACTIVE	SOIC	D	14	2500	Green (RoHS & no Sb/Br)	CU NIPDAU	Level-1-260C-UNLIM	-40 to 125	LMV324Q	<a href="#">Samples</a>
LMV324QDRG4	ACTIVE	SOIC	D	14	2500	Green (RoHS & no Sb/Br)	CU NIPDAU	Level-1-260C-UNLIM	-40 to 125	LMV324Q	<a href="#">Samples</a>
LMV324QPW	ACTIVE	TSSOP	PW	14	90	Green (RoHS & no Sb/Br)	CU NIPDAU	Level-1-260C-UNLIM	-40 to 125	MV324Q	<a href="#">Samples</a>
LMV324QPWR	ACTIVE	TSSOP	PW	14	2000	Green (RoHS & no Sb/Br)	CU NIPDAU	Level-1-260C-UNLIM	-40 to 125	MV324Q	<a href="#">Samples</a>
LMV324QPWRE4	ACTIVE	TSSOP	PW	14	2000	Green (RoHS & no Sb/Br)	CU NIPDAU	Level-1-260C-UNLIM	-40 to 125	MV324Q	<a href="#">Samples</a>
LMV358ID	ACTIVE	SOIC	D	8	75	Green (RoHS & no Sb/Br)	CU NIPDAU	Level-1-260C-UNLIM	-40 to 125	MV358I	<a href="#">Samples</a>
LMV358IDDUR	ACTIVE	VSSOP	DDU	8	3000	Green (RoHS & no Sb/Br)	CU NIPDAU	Level-1-260C-UNLIM	-40 to 125	RA5R	<a href="#">Samples</a>
LMV358IDDURG4	ACTIVE	VSSOP	DDU	8	3000	Green (RoHS & no Sb/Br)	CU NIPDAU	Level-1-260C-UNLIM	-40 to 125	RA5R	<a href="#">Samples</a>
LMV358IDG4	ACTIVE	SOIC	D	8	75	Green (RoHS & no Sb/Br)	CU NIPDAU	Level-1-260C-UNLIM	-40 to 125	MV358I	<a href="#">Samples</a>
LMV358IDGKR	ACTIVE	VSSOP	DGK	8	2500	Green (RoHS & no Sb/Br)	CU NIPDAU	Level-1-260C-UNLIM	-40 to 125	(R5B, R5Q, R5R)	<a href="#">Samples</a>
LMV358IDGKRG4	ACTIVE	VSSOP	DGK	8	2500	Green (RoHS & no Sb/Br)	CU NIPDAU	Level-1-260C-UNLIM	-40 to 125	(R5B, R5Q, R5R)	<a href="#">Samples</a>
LMV358IDR	ACTIVE	SOIC	D	8	2500	Green (RoHS & no Sb/Br)	CU NIPDAU   CU SN	Level-1-260C-UNLIM	-40 to 125	MV358I	<a href="#">Samples</a>
LMV358IDRE4	ACTIVE	SOIC	D	8	2500	Green (RoHS & no Sb/Br)	CU NIPDAU	Level-1-260C-UNLIM	-40 to 125	MV358I	<a href="#">Samples</a>
LMV358IDRG4	ACTIVE	SOIC	D	8	2500	Green (RoHS & no Sb/Br)	CU NIPDAU	Level-1-260C-UNLIM	-40 to 125	MV358I	<a href="#">Samples</a>
LMV358IPW	ACTIVE	TSSOP	PW	8	150	Green (RoHS & no Sb/Br)	CU NIPDAU	Level-1-260C-UNLIM	-40 to 125	MV358I	<a href="#">Samples</a>
LMV358IPWG4	ACTIVE	TSSOP	PW	8	150	Green (RoHS & no Sb/Br)	CU NIPDAU	Level-1-260C-UNLIM	-40 to 125	MV358I	<a href="#">Samples</a>
LMV358IPWR	ACTIVE	TSSOP	PW	8	2000	Green (RoHS & no Sb/Br)	CU NIPDAU   CU SN	Level-1-260C-UNLIM	-40 to 125	MV358I	<a href="#">Samples</a>
LMV358IPWRE4	ACTIVE	TSSOP	PW	8	2000	Green (RoHS & no Sb/Br)	CU NIPDAU	Level-1-260C-UNLIM	-40 to 125	MV358I	<a href="#">Samples</a>

Orderable Device	Status (1)	Package Type	Package Drawing	Pins	Package Qty	Eco Plan (2)	Lead/Ball Finish (6)	MSL Peak Temp (3)	Op Temp (°C)	Device Marking (4/5)	Samples
LMV358IPWRG4	ACTIVE	TSSOP	PW	8	2000	Green (RoHS & no Sb/Br)	CU NIPDAU	Level-1-260C-UNLIM	-40 to 125	MV358I	<a href="#">Samples</a>
LMV358QD	ACTIVE	SOIC	D	8	75	Green (RoHS & no Sb/Br)	CU NIPDAU	Level-1-260C-UNLIM	-40 to 125	MV358Q	<a href="#">Samples</a>
LMV358QDDUR	ACTIVE	VSSOP	DDU	8	3000	Green (RoHS & no Sb/Br)	CU NIPDAU	Level-1-260C-UNLIM	-40 to 125	RAHR	<a href="#">Samples</a>
LMV358QDDURG4	ACTIVE	VSSOP	DDU	8	3000	Green (RoHS & no Sb/Br)	CU NIPDAU	Level-1-260C-UNLIM	-40 to 125	RAHR	<a href="#">Samples</a>
LMV358QDQ4	ACTIVE	SOIC	D	8	75	Green (RoHS & no Sb/Br)	CU NIPDAU	Level-1-260C-UNLIM	-40 to 125	MV358Q	<a href="#">Samples</a>
LMV358QDQKR	ACTIVE	VSSOP	DGK	8	2500	Green (RoHS & no Sb/Br)	CU NIPDAU	Level-1-260C-UNLIM	-40 to 125	(RHO, RHR)	<a href="#">Samples</a>
LMV358QDQKRG4	ACTIVE	VSSOP	DGK	8	2500	Green (RoHS & no Sb/Br)	CU NIPDAU	Level-1-260C-UNLIM	-40 to 125	(RHO, RHR)	<a href="#">Samples</a>
LMV358QDR	ACTIVE	SOIC	D	8	2500	Green (RoHS & no Sb/Br)	CU NIPDAU	Level-1-260C-UNLIM	-40 to 125	MV358Q	<a href="#">Samples</a>
LMV358QPWR	ACTIVE	TSSOP	PW	8	2000	Green (RoHS & no Sb/Br)	CU NIPDAU	Level-1-260C-UNLIM	-40 to 125	MV358Q	<a href="#">Samples</a>

(1) The marketing status values are defined as follows:

**ACTIVE:** Product device recommended for new designs.

**LIFEBUY:** TI has announced that the device will be discontinued, and a lifetime-buy period is in effect.

**NRND:** Not recommended for new designs. Device is in production to support existing customers, but TI does not recommend using this part in a new design.

**PREVIEW:** Device has been announced but is not in production. Samples may or may not be available.

**OBSELETE:** TI has discontinued the production of the device.

(2) **RoHS:** TI defines "RoHS" to mean semiconductor products that are compliant with the current EU RoHS requirements for all 10 RoHS substances, including the requirement that RoHS substance do not exceed 0.1% by weight in homogeneous materials. Where designed to be soldered at high temperatures, "RoHS" products are suitable for use in specified lead-free processes. TI may reference these types of products as "Pb-Free".

**RoHS Exempt:** TI defines "RoHS Exempt" to mean products that contain lead but are compliant with EU RoHS pursuant to a specific EU RoHS exemption.

**Green:** TI defines "Green" to mean the content of Chlorine (Cl) and Bromine (Br) based flame retardants meet JS709B low halogen requirements of <=1000ppm threshold. Antimony trioxide based flame retardants must also meet the <=1000ppm threshold requirement.

(3) MSL, Peak Temp. - The Moisture Sensitivity Level rating according to the JEDEC industry standard classifications, and peak solder temperature.

(4) There may be additional marking, which relates to the logo, the lot trace code information, or the environmental category on the device.

<sup>(5)</sup> Multiple Device Markings will be inside parentheses. Only one Device Marking contained in parentheses and separated by a "-" will appear on a device. If a line is indented then it is a continuation of the previous line and the two combined represent the entire Device Marking for that device.

<sup>(6)</sup> Lead/Ball Finish - Orderable Devices may have multiple material finish options. Finish options are separated by a vertical ruled line. Lead/Ball Finish values may wrap to two lines if the finish value exceeds the maximum column width.

**Important Information and Disclaimer:**The information provided on this page represents TI's knowledge and belief as of the date that it is provided. TI bases its knowledge and belief on information provided by third parties, and makes no representation or warranty as to the accuracy of such information. Efforts are underway to better integrate information from third parties. TI has taken and continues to take reasonable steps to provide representative and accurate information but may not have conducted destructive testing or chemical analysis on incoming materials and chemicals. TI and TI suppliers consider certain information to be proprietary, and thus CAS numbers and other limited information may not be available for release.

In no event shall TI's liability arising out of such information exceed the total purchase price of the TI part(s) at issue in this document sold by TI to Customer on an annual basis.

## TAPE AND REEL INFORMATION



### QUADRANT ASSIGNMENTS FOR PIN 1 ORIENTATION IN TAPE



\*All dimensions are nominal

Device	Package Type	Package Drawing	Pins	SPQ	Reel Diameter (mm)	Reel Width W1 (mm)	A0 (mm)	B0 (mm)	K0 (mm)	P1 (mm)	W (mm)	Pin1 Quadrant
LMV321IDBVR	SOT-23	DBV	5	3000	178.0	9.0	3.23	3.17	1.37	4.0	8.0	Q3
LMV321IDBVT	SOT-23	DBV	5	250	178.0	9.0	3.23	3.17	1.37	4.0	8.0	Q3
LMV321IDCKR	SC70	DCK	5	3000	178.0	9.0	2.4	2.5	1.2	4.0	8.0	Q3
LMV321IDCKR	SC70	DCK	5	3000	180.0	9.2	2.3	2.55	1.2	4.0	8.0	Q3
LMV321IDCKT	SC70	DCK	5	250	180.0	9.2	2.3	2.55	1.2	4.0	8.0	Q3
LMV321IDCKT	SC70	DCK	5	250	178.0	9.0	2.4	2.5	1.2	4.0	8.0	Q3
LMV324IDR	SOIC	D	14	2500	330.0	16.4	6.5	9.0	2.1	8.0	16.0	Q1
LMV324IDR	SOIC	D	14	2500	330.0	16.8	6.5	9.5	2.1	8.0	16.0	Q1
LMV324IDR	SOIC	D	14	2500	330.0	16.4	6.5	9.0	2.1	8.0	16.0	Q1
LMV324IDRG4	SOIC	D	14	2500	330.0	16.4	6.5	9.0	2.1	8.0	16.0	Q1
LMV324IPWR	TSSOP	PW	14	2000	330.0	12.4	6.9	5.6	1.6	8.0	12.0	Q1
LMV324IPWR	TSSOP	PW	14	2000	330.0	12.4	6.9	5.6	1.6	8.0	12.0	Q1
LMV324IPWRG4	TSSOP	PW	14	2000	330.0	12.4	6.9	5.6	1.6	8.0	12.0	Q1
LMV324QDR	SOIC	D	14	2500	330.0	16.4	6.5	9.0	2.1	8.0	16.0	Q1
LMV324QPWR	TSSOP	PW	14	2000	330.0	12.4	6.9	5.6	1.6	8.0	12.0	Q1
LMV358IDDUR	VSSOP	DDU	8	3000	180.0	8.4	2.25	3.35	1.05	4.0	8.0	Q3
LMV358IDGKR	VSSOP	DGK	8	2500	330.0	12.4	5.3	3.4	1.4	8.0	12.0	Q1
LMV358IDR	SOIC	D	8	2500	330.0	12.4	6.4	5.2	2.1	8.0	12.0	Q1

Device	Package Type	Package Drawing	Pins	SPQ	Reel Diameter (mm)	Reel Width W1 (mm)	A0 (mm)	B0 (mm)	K0 (mm)	P1 (mm)	W (mm)	Pin1 Quadrant
LMV358IDR	SOIC	D	8	2500	330.0	12.4	6.4	5.2	2.1	8.0	12.0	Q1
LMV358IDR	SOIC	D	8	2500	330.0	12.8	6.4	5.2	2.1	8.0	12.0	Q1
LMV358IDRG4	SOIC	D	8	2500	330.0	12.4	6.4	5.2	2.1	8.0	12.0	Q1
LMV358IPWR	TSSOP	PW	8	2000	330.0	12.4	7.0	3.6	1.6	8.0	12.0	Q1
LMV358IPWR	TSSOP	PW	8	2000	330.0	12.4	7.0	3.6	1.6	8.0	12.0	Q1
LMV358IPWRG4	TSSOP	PW	8	2000	330.0	12.4	7.0	3.6	1.6	8.0	12.0	Q1
LMV358QDDUR	VSSOP	DDU	8	3000	180.0	8.4	2.25	3.35	1.05	4.0	8.0	Q3
LMV358QDGKR	VSSOP	DGK	8	2500	330.0	12.4	5.3	3.4	1.4	8.0	12.0	Q1
LMV358QDR	SOIC	D	8	2500	330.0	12.4	6.4	5.2	2.1	8.0	12.0	Q1
LMV358QPWR	TSSOP	PW	8	2000	330.0	12.4	7.0	3.6	1.6	8.0	12.0	Q1

**TAPE AND REEL BOX DIMENSIONS**

\*All dimensions are nominal

Device	Package Type	Package Drawing	Pins	SPQ	Length (mm)	Width (mm)	Height (mm)
LMV321IDBVR	SOT-23	DBV	5	3000	180.0	180.0	18.0
LMV321IDBVT	SOT-23	DBV	5	250	180.0	180.0	18.0
LMV321IDCKR	SC70	DCK	5	3000	180.0	180.0	18.0
LMV321IDCKR	SC70	DCK	5	3000	205.0	200.0	33.0
LMV321IDCKT	SC70	DCK	5	250	205.0	200.0	33.0
LMV321IDCKT	SC70	DCK	5	250	180.0	180.0	18.0
LMV324IDR	SOIC	D	14	2500	367.0	367.0	38.0

Device	Package Type	Package Drawing	Pins	SPQ	Length (mm)	Width (mm)	Height (mm)
LMV324IDR	SOIC	D	14	2500	364.0	364.0	27.0
LMV324IDR	SOIC	D	14	2500	333.2	345.9	28.6
LMV324IDRG4	SOIC	D	14	2500	333.2	345.9	28.6
LMV324IPWR	TSSOP	PW	14	2000	367.0	367.0	35.0
LMV324IPWR	TSSOP	PW	14	2000	364.0	364.0	27.0
LMV324IPWRG4	TSSOP	PW	14	2000	367.0	367.0	35.0
LMV324QDR	SOIC	D	14	2500	367.0	367.0	38.0
LMV324QPWR	TSSOP	PW	14	2000	367.0	367.0	35.0
LMV358IDDUR	VSSOP	DDU	8	3000	202.0	201.0	28.0
LMV358IDGKR	VSSOP	DGK	8	2500	358.0	335.0	35.0
LMV358IDR	SOIC	D	8	2500	367.0	367.0	35.0
LMV358IDR	SOIC	D	8	2500	340.5	338.1	20.6
LMV358IDR	SOIC	D	8	2500	364.0	364.0	27.0
LMV358IDRG4	SOIC	D	8	2500	340.5	338.1	20.6
LMV358IPWR	TSSOP	PW	8	2000	364.0	364.0	27.0
LMV358IPWR	TSSOP	PW	8	2000	367.0	367.0	35.0
LMV358IPWRG4	TSSOP	PW	8	2000	367.0	367.0	35.0
LMV358QDDUR	VSSOP	DDU	8	3000	202.0	201.0	28.0
LMV358QDGKR	VSSOP	DGK	8	2500	358.0	335.0	35.0
LMV358QDR	SOIC	D	8	2500	340.5	338.1	20.6
LMV358QPWR	TSSOP	PW	8	2000	367.0	367.0	35.0



DCK (R-PDSO-G5)

PLASTIC SMALL OUTLINE



- NOTES:
- All linear dimensions are in millimeters.
  - This drawing is subject to change without notice.
  - Customers should place a note on the circuit board fabrication drawing not to alter the center solder mask defined pad.
  - Publication IPC-7351 is recommended for alternate designs.
  - Laser cutting apertures with trapezoidal walls and also rounding corners will offer better paste release. Customers should contact their board assembly site for stencil design recommendations. Example stencil design based on a 50% volumetric metal load solder paste. Refer to IPC-7525 for other stencil recommendations.



DDU (S-PDSO-G8)

PLASTIC SMALL OUTLINE PACKAGE (DIE UP)

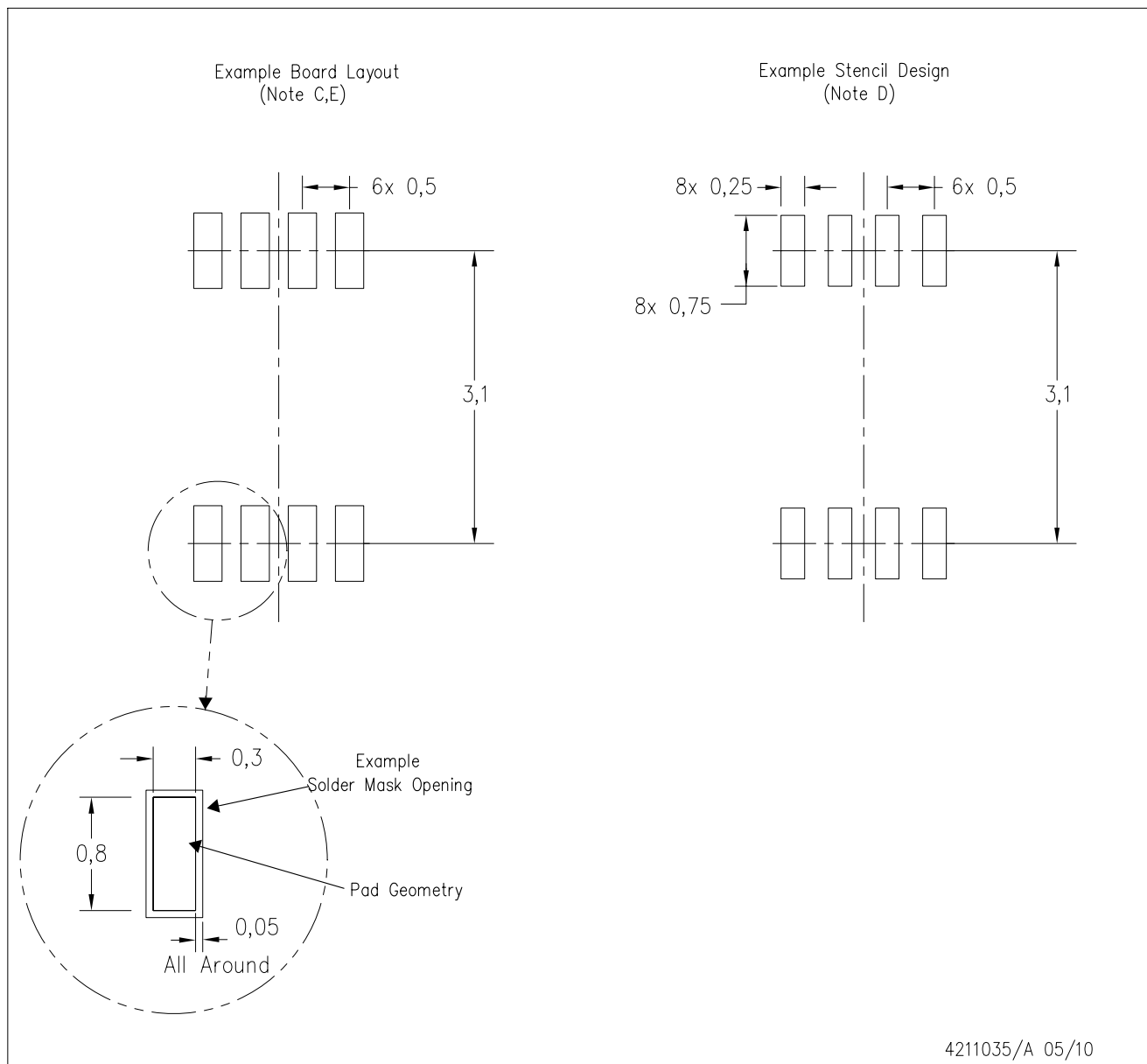

- NOTES:
- All linear dimensions are in millimeters.
  - This drawing is subject to change without notice.
  - Publication IPC-7351 is recommended for alternate designs.
  - Laser cutting apertures with trapezoidal walls and also rounding corners will offer better paste release. Customers should contact their board assembly site for stencil design recommendations. Refer to IPC-7525.
  - Customers should contact their board fabrication site for solder mask tolerances between and around signal pads.

D (R-PDSO-G14)

PLASTIC SMALL OUTLINE



- NOTES:
- A. All linear dimensions are in inches (millimeters).
  - B. This drawing is subject to change without notice.
  - Body length does not include mold flash, protrusions, or gate burrs. Mold flash, protrusions, or gate burrs shall not exceed 0.006 (0,15) each side.
  - Body width does not include interlead flash. Interlead flash shall not exceed 0.017 (0,43) each side.
  - E. Reference JEDEC MS-012 variation AB.

D (R-PDSO-G14)

PLASTIC SMALL OUTLINE



4211283-3/E 08/12

- NOTES:
- All linear dimensions are in millimeters.
  - This drawing is subject to change without notice.
  - Publication IPC-7351 is recommended for alternate designs.
  - Laser cutting apertures with trapezoidal walls and also rounding corners will offer better paste release. Customers should contact their board assembly site for stencil design recommendations. Refer to IPC-7525 for other stencil recommendations.
  - Customers should contact their board fabrication site for solder mask tolerances between and around signal pads.

PW (R-PDSO-G14)

PLASTIC SMALL OUTLINE

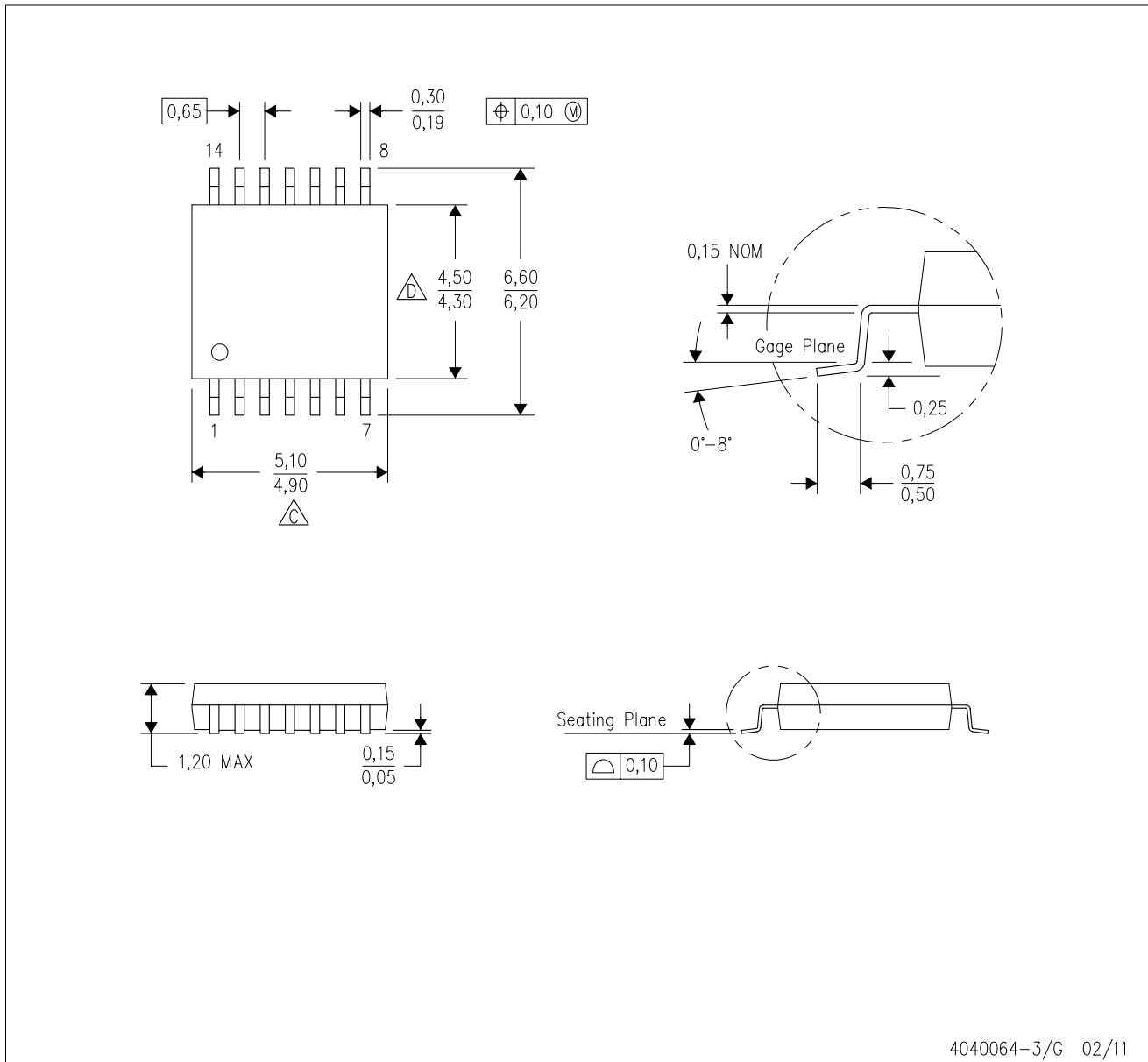

- NOTES:
- A. All linear dimensions are in millimeters. Dimensioning and tolerancing per ASME Y14.5M-1994.
  - B. This drawing is subject to change without notice.
  - C. Body length does not include mold flash, protrusions, or gate burrs. Mold flash, protrusions, or gate burrs shall not exceed 0,15 each side.
  - D. Body width does not include interlead flash. Interlead flash shall not exceed 0,25 each side.
  - E. Falls within JEDEC MO-153

PW (R-PDSO-G14)

PLASTIC SMALL OUTLINE

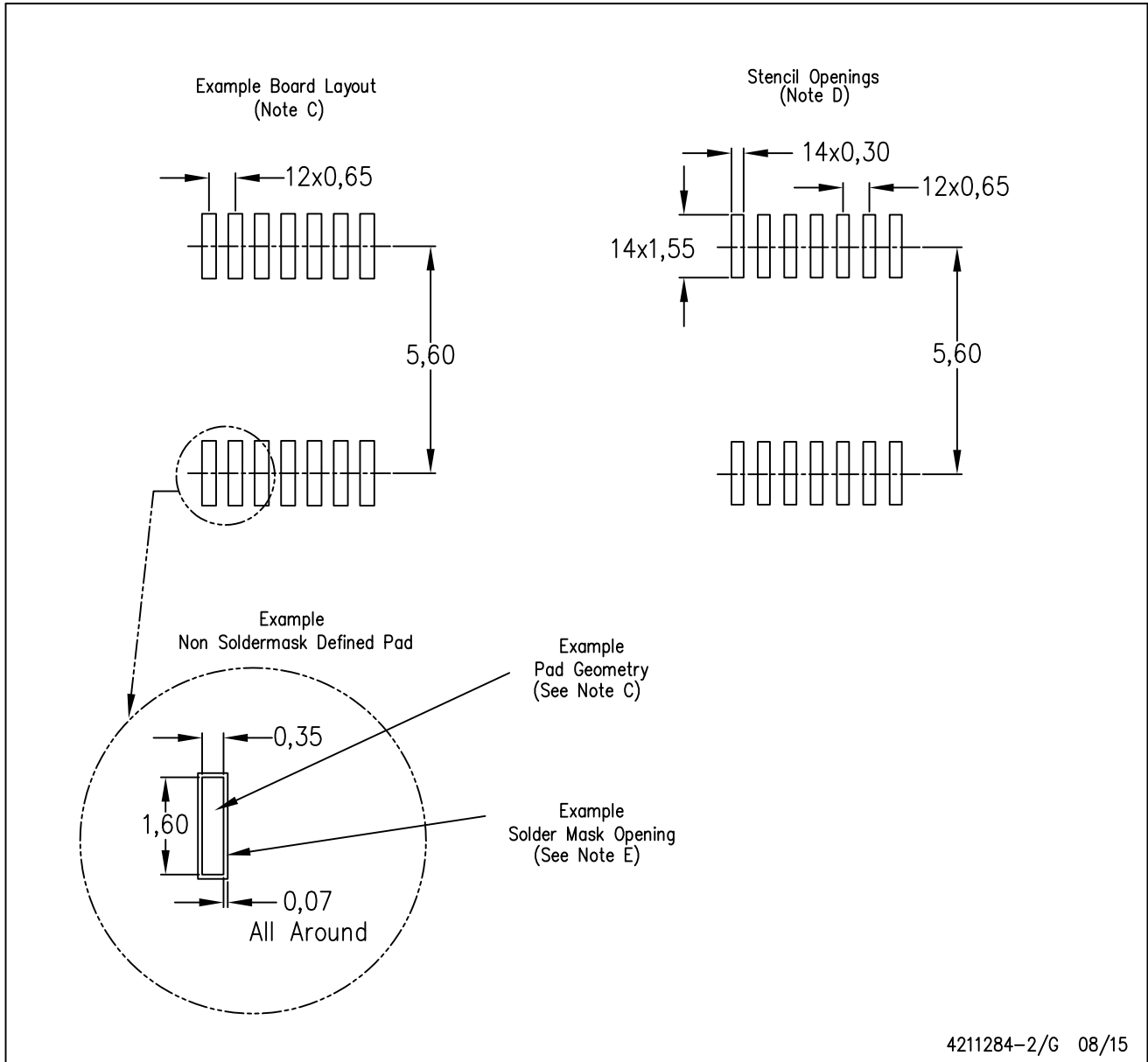

- NOTES:
- All linear dimensions are in millimeters.
  - This drawing is subject to change without notice.
  - Publication IPC-7351 is recommended for alternate designs.
  - Laser cutting apertures with trapezoidal walls and also rounding corners will offer better paste release. Customers should contact their board assembly site for stencil design recommendations. Refer to IPC-7525 for other stencil recommendations.
  - Customers should contact their board fabrication site for solder mask tolerances between and around signal pads.



# EXAMPLE BOARD LAYOUT

D0008A

SOIC - 1.75 mm max height

SMALL OUTLINE INTEGRATED CIRCUIT



LAND PATTERN EXAMPLE  
 EXPOSED METAL SHOWN  
 SCALE:8X



SOLDER MASK DETAILS

4214825/C 02/2019

NOTES: (continued)

- 6. Publication IPC-7351 may have alternate designs.
- 7. Solder mask tolerances between and around signal pads can vary based on board fabrication site.

# EXAMPLE STENCIL DESIGN

D0008A

SOIC - 1.75 mm max height

SMALL OUTLINE INTEGRATED CIRCUIT



SOLDER PASTE EXAMPLE  
BASED ON .005 INCH [0.125 MM] THICK STENCIL  
SCALE:8X

4214825/C 02/2019

NOTES: (continued)

8. Laser cutting apertures with trapezoidal walls and rounded corners may offer better paste release. IPC-7525 may have alternate design recommendations.
9. Board assembly site may have different recommendations for stencil design.

DBV0005A



# PACKAGE OUTLINE

SOT-23 - 1.45 mm max height

SMALL OUTLINE TRANSISTOR



4214839/D 11/2018

## NOTES:

1. All linear dimensions are in millimeters. Any dimensions in parenthesis are for reference only. Dimensioning and tolerancing per ASME Y14.5M.
2. This drawing is subject to change without notice.
3. Reference JEDEC MO-178.
4. Body dimensions do not include mold flash, protrusions, or gate burrs. Mold flash, protrusions, or gate burrs shall not exceed 0.15 mm per side.



# EXAMPLE STENCIL DESIGN

DBV0005A

SOT-23 - 1.45 mm max height

SMALL OUTLINE TRANSISTOR



SOLDER PASTE EXAMPLE  
BASED ON 0.125 mm THICK STENCIL  
SCALE:15X

4214839/D 11/2018

NOTES: (continued)

7. Laser cutting apertures with trapezoidal walls and rounded corners may offer better paste release. IPC-7525 may have alternate design recommendations.
8. Board assembly site may have different recommendations for stencil design.





- NOTES:
- A. All linear dimensions are in millimeters.
  - B. This drawing is subject to change without notice.
  - C. Publication IPC-7351 is recommended for alternate designs.
  - D. Laser cutting apertures with trapezoidal walls and also rounding corners will offer better paste release. Customers should contact their board assembly site for stencil design recommendations. Refer to IPC-7525 for other stencil recommendations.
  - E. Customers should contact their board fabrication site for solder mask tolerances between and around signal pads.

PW0008A



# PACKAGE OUTLINE

## TSSOP - 1.2 mm max height

SMALL OUTLINE PACKAGE

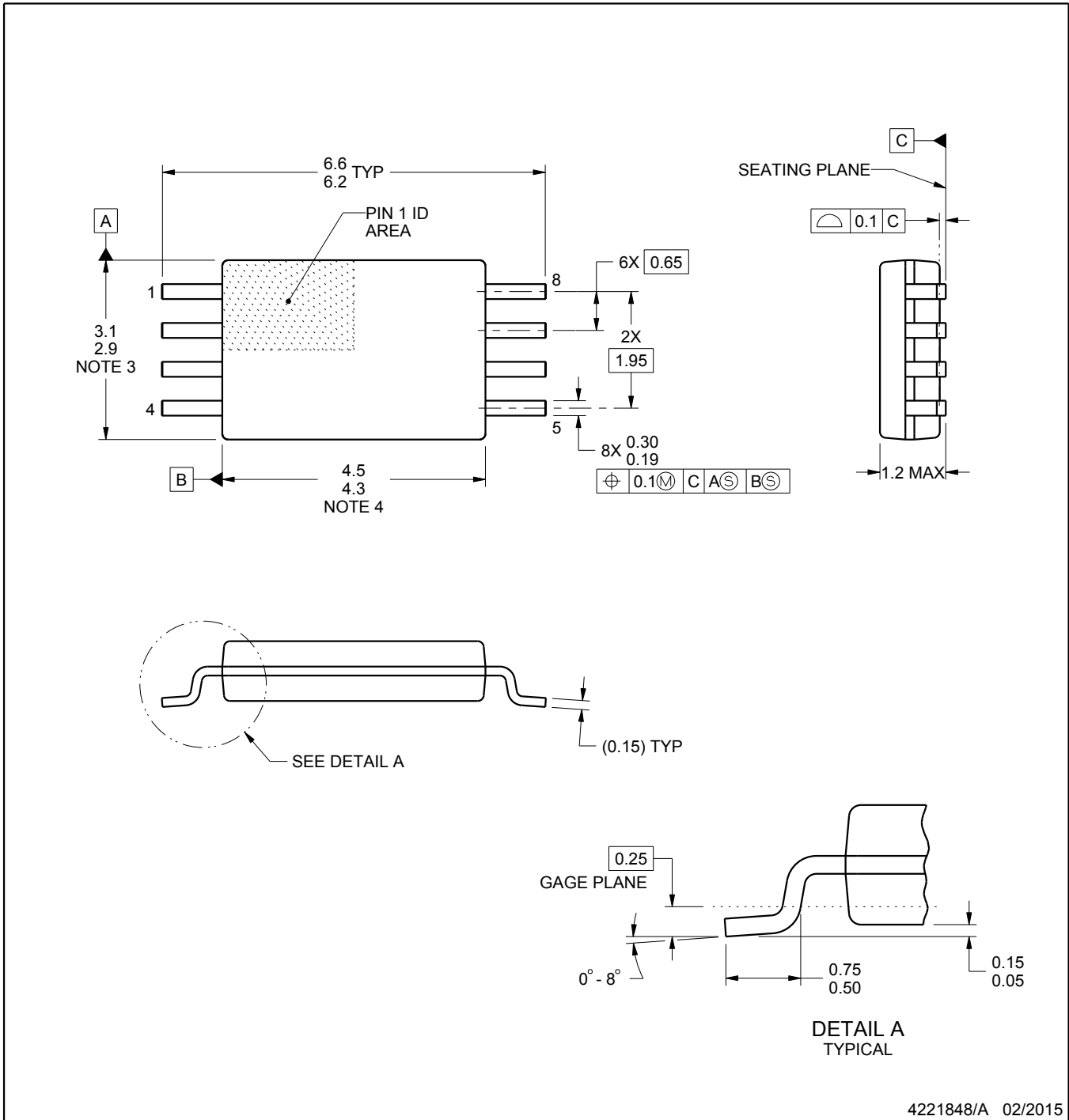

4221848/A 02/2015

**NOTES:**

1. All linear dimensions are in millimeters. Any dimensions in parenthesis are for reference only. Dimensioning and tolerancing per ASME Y14.5M.
2. This drawing is subject to change without notice.
3. This dimension does not include mold flash, protrusions, or gate burrs. Mold flash, protrusions, or gate burrs shall not exceed 0.15 mm per side.
4. This dimension does not include interlead flash. Interlead flash shall not exceed 0.25 mm per side.
5. Reference JEDEC registration MO-153, variation AA.

# EXAMPLE BOARD LAYOUT

PW0008A

TSSOP - 1.2 mm max height

SMALL OUTLINE PACKAGE

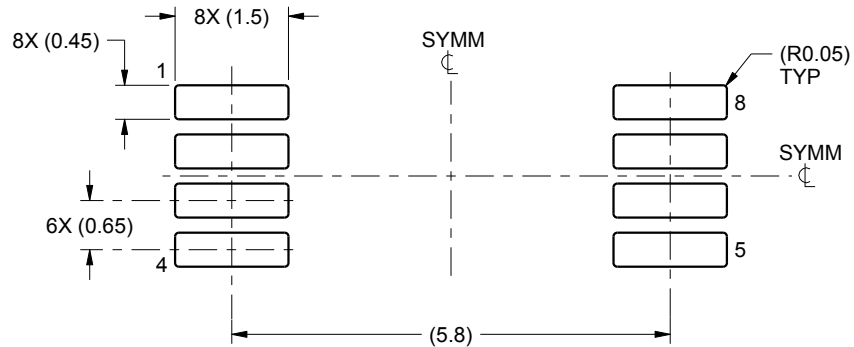

LAND PATTERN EXAMPLE  
SCALE:10X

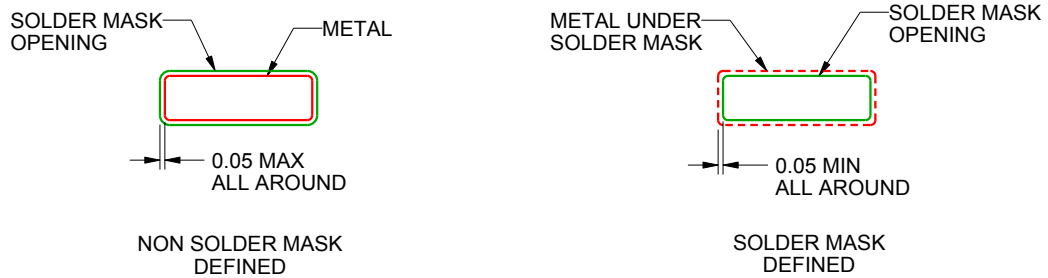

SOLDER MASK DETAILS  
NOT TO SCALE

4221848/A 02/2015

NOTES: (continued)

- 6. Publication IPC-7351 may have alternate designs.
- 7. Solder mask tolerances between and around signal pads can vary based on board fabrication site.

# EXAMPLE STENCIL DESIGN

PW0008A

TSSOP - 1.2 mm max height

SMALL OUTLINE PACKAGE



SOLDER PASTE EXAMPLE  
BASED ON 0.125 mm THICK STENCIL  
SCALE:10X

4221848/A 02/2015

NOTES: (continued)

8. Laser cutting apertures with trapezoidal walls and rounded corners may offer better paste release. IPC-7525 may have alternate design recommendations.
9. Board assembly site may have different recommendations for stencil design.

## IMPORTANT NOTICE AND DISCLAIMER

TI PROVIDES TECHNICAL AND RELIABILITY DATA (INCLUDING DATASHEETS), DESIGN RESOURCES (INCLUDING REFERENCE DESIGNS), APPLICATION OR OTHER DESIGN ADVICE, WEB TOOLS, SAFETY INFORMATION, AND OTHER RESOURCES "AS IS" AND WITH ALL FAULTS, AND DISCLAIMS ALL WARRANTIES, EXPRESS AND IMPLIED, INCLUDING WITHOUT LIMITATION ANY IMPLIED WARRANTIES OF MERCHANTABILITY, FITNESS FOR A PARTICULAR PURPOSE OR NON-INFRINGEMENT OF THIRD PARTY INTELLECTUAL PROPERTY RIGHTS.

These resources are intended for skilled developers designing with TI products. You are solely responsible for (1) selecting the appropriate TI products for your application, (2) designing, validating and testing your application, and (3) ensuring your application meets applicable standards, and any other safety, security, or other requirements. These resources are subject to change without notice. TI grants you permission to use these resources only for development of an application that uses the TI products described in the resource. Other reproduction and display of these resources is prohibited. No license is granted to any other TI intellectual property right or to any third party intellectual property right. TI disclaims responsibility for, and you will fully indemnify TI and its representatives against, any claims, damages, costs, losses, and liabilities arising out of your use of these resources.

TI's products are provided subject to TI's Terms of Sale ([www.ti.com/legal/termsofsale.html](http://www.ti.com/legal/termsofsale.html)) or other applicable terms available either on [ti.com](http://ti.com) or provided in conjunction with such TI products. TI's provision of these resources does not expand or otherwise alter TI's applicable warranties or warranty disclaimers for TI products.

Mailing Address: Texas Instruments, Post Office Box 655303, Dallas, Texas 75265  
Copyright © 2019, Texas Instruments Incorporated

## Looking for pricing, stock, or lifecycle information?

Click below to explore more details on WIN SOURCE:

 [View LMV358IDRG4](#) on WIN SOURCE

 [Texas Instruments](#) Information

## Optimize Your Supply Chain with WIN SOURCE Solutions

-  Global Sourcing Solution
-  Obsolete Management
-  Cost Control Management
-  Shortage Management
-  Alternative Solution
-  Excess Inventory Management