



THE DATASHEET OF LMV824IDE4



LOW-VOLTAGE RAIL-TO-RAIL OUTPUT OPERATIONAL AMPLIFIERS

Check for Samples: [LMV821 SINGLE](#), [LMV822 DUAL](#), [LMV824 QUAD](#)

FEATURES

- **2.5-V, 2.7-V, and 5-V Performance**
- **–40°C to 125°C Operation**
- **No Crossover Distortion**
- **Low Supply Current at $V_{CC+} = 5\text{ V}$:**
 - LMV821...0.3 mA Typ
 - LMV822...0.5 mA Typ
 - LMV824...1 mA Typ
- **Rail-to-Rail Output Swing**
- **Gain Bandwidth of 5.5 MHz Typ at 5 V**
- **Slew Rate of 1.9 V/ μs Typ at 5 V**

The LMV8xx devices are characterized for operation from –40°C to 85°C. The LMV8xxl devices are characterized for operation from –40°C to 125°C.

DESCRIPTION/ ORDERING INFORMATION

The LMV821 single, LMV822 dual, and LMV824 quad devices are low-voltage (2.5 V to 5.5 V), low-power commodity operational amplifiers. Electrical characteristics are very similar to the LMV3xx operational amplifiers (low supply current, rail-to-rail outputs, input common-mode range that includes ground). However, the LMV8xx devices offer a higher bandwidth (5.5 MHz typical) and faster slew rate (1.9 V/ μs typical).

The LMV8xx devices are cost-effective solutions for applications requiring low-voltage/low-power operation and space-saving considerations. The LMV821 is available in the ultra-small DCK package, which is approximately half the size of SOT-23-5. The DCK package saves space on printed circuit boards and enables the design of small portable electronic devices (cordless and cellular phones, laptops, PDAs, PCMIA). It also allows the designer to place the device closer to the signal source to reduce noise pickup and increase signal integrity.

**LMV824 . . . D, DGV, OR PW PACKAGE
(TOP VIEW)**



**LMV822 . . . D OR DGK PACKAGE
(TOP VIEW)**



**LMV821 . . . DBV OR DCK PACKAGE
(TOP VIEW)**



Please be aware that an important notice concerning availability, standard warranty, and use in critical applications of Texas Instruments semiconductor products and disclaimers thereto appears at the end of this data sheet.

LMV821 SINGLE, LMV822 DUAL, LMV824 QUAD

SLOS434I – FEBRUARY 2004 – REVISED JULY 2006

www.ti.com

ORDERING INFORMATION

T _A	PACKAGE ⁽¹⁾		ORDERABLE PART NUMBER	TOP-SIDE MARKING ⁽²⁾	
–40°C to 85°C	Single	SC-70 – DCK	Reel of 3000	LMV821DCKR	RY_
			Reel of 250	LMV821DCKT	
		SOT-23 – DBV	Reel of 3000	LMV821DBVR	RB8_
			Reel of 250	LMV821DBVT	
	Dual	SOIC – D	Tube of 75	LMV822D	MV822
			Reel of 2500	LMV822DR	
		MSOP/VSSOP – DGK	Tube of 100	LMV822DGK	RA_
			Reel of 2500	LMV822DGKR	
	Quad	SOIC – D	Tube of 50	LMV824D	LMV824
			Reel of 2500	LMV824DR	
		TSSOP – PW	Tube of 90	LMV824PW	MV824
			Reel of 2000	LMV824PWR	
TVSOP – DGV		Reel of 2000	LMV824DGV	MV824	
–40°C to 125°C	Single	SC-70 – DCK	Reel of 3000	LMV821IDCKR	RZ_
			Reel of 250	LMV821IDCKT	
		SOT-23 – DBV	Reel of 3000	LMV821IDBVR	RB1_
			Reel of 250	LMV821IDBVT	
	Dual	SOIC – D	Tube of 75	LMV822ID	MV822I
			Reel of 2500	LMV822IDR	
		MSOP/VSSOP – DGK	Tube of 100	LMV822IDGK	R8_
			Reel of 2500	LMV822IDGKR	
	Quad	SOIC – D	Tube of 50	LMV824ID	LMV824I
			Reel of 2500	LMV824IDR	
		TSSOP – PW	Tube of 90	LMV824IPW	MV824I
			Reel of 2000	LMV824IPWR	
TVSOP – DGV		Reel of 2000	LMV824IDGVR	MV824I	

(1) Package drawings, standard packing quantities, thermal data, symbolization, and PCB design guidelines are available at www.ti.com/sc/package.

(2) DBV/DCK/DGK: The actual top-side marking has one additional character that designates the assembly/test site.

Figure 1. SYMBOL (EACH AMPLIFIER)

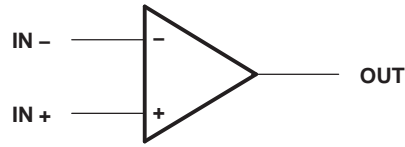
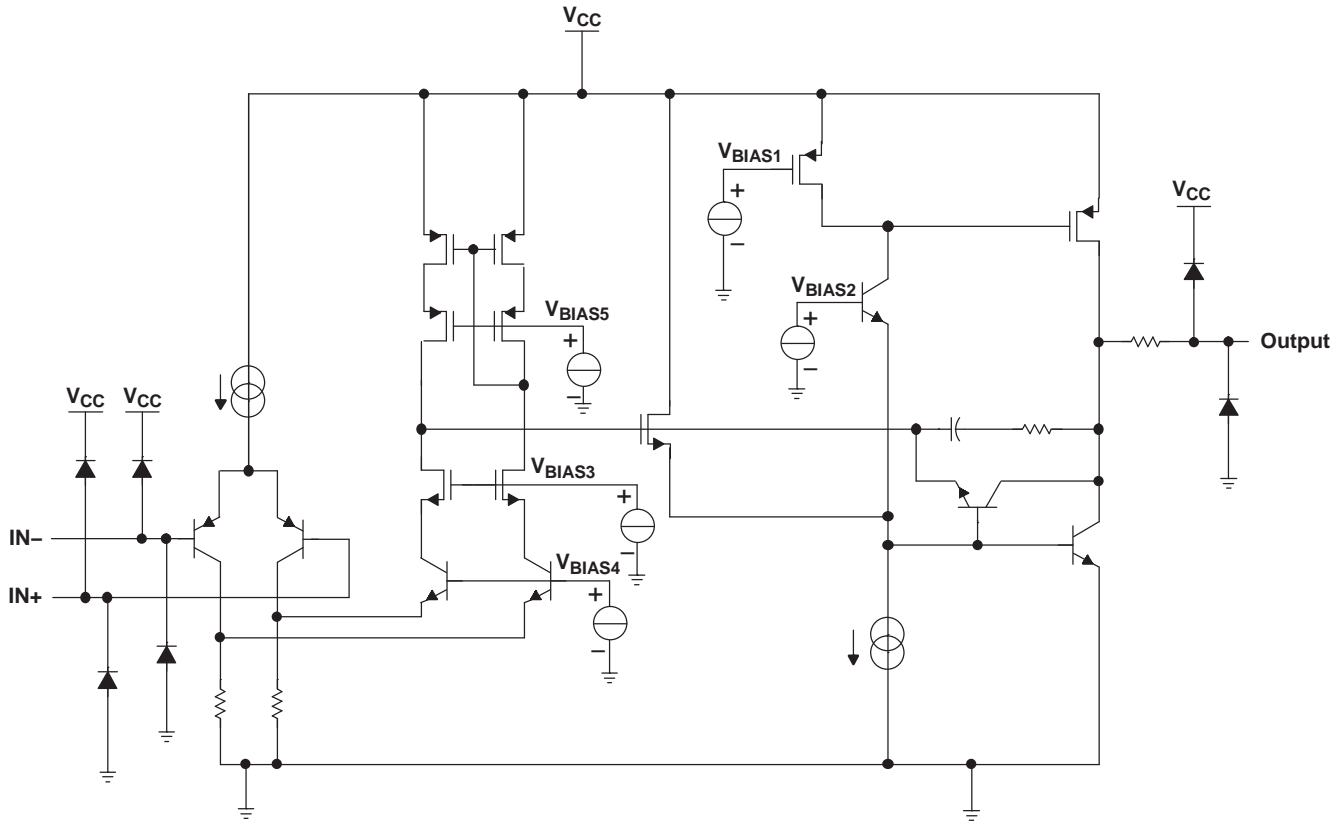

Figure 2. LMV824 SIMPLIFIED SCHEMATIC



LMV821 SINGLE, LMV822 DUAL, LMV824 QUAD

SLOS434I – FEBRUARY 2004 – REVISED JULY 2006

www.ti.com

Absolute Maximum Ratings⁽¹⁾

over operating free-air temperature range (unless otherwise noted)

		MIN	MAX	UNIT	
V _{CC}	Supply voltage ⁽²⁾		5.5	V	
V _{ID}	Differential input voltage ⁽³⁾		±V _{CC}	V	
V _I	Input voltage range (either input)	V _{CC-}	V _{CC+}	V	
Duration of output short circuit (one amplifier) to ground ⁽⁴⁾		At or below T _A = 25°C, V _{CC} ≤ 5.5 V		Unlimited	
θ _{JA}	Package thermal impedance ^{(5) (6)}	D package	8 pin	97	°C/W
			14 pin	86	
		DBV package		206	
		DCK package		252	
		DGK package		172	
		DGV package		127	
		PW package		113	
T _J	Operating virtual junction temperature		150	°C	
T _{stg}	Storage temperature range	-65	150	°C	

- (1) Stresses beyond those listed under “absolute maximum ratings” may cause permanent damage to the device. These are stress ratings only, and functional operation of the device at these or any other conditions beyond those indicated under “recommended operating conditions” is not implied. Exposure to absolute-maximum-rated conditions for extended periods may affect device reliability.
- (2) All voltage values (except differential voltages and V_{CC} specified for the measurement of I_{OS}) are with respect to the network GND.
- (3) Differential voltages are at IN+ with respect to IN-.
- (4) Short circuits from outputs to V_{CC} can cause excessive heating and eventual destruction.
- (5) Maximum power dissipation is a function of T_{J(max)}, θ_{JA}, and T_A. The maximum allowable power dissipation at any allowable ambient temperature is P_D = (T_{J(max)} – T_A)/θ_{JA}. Operating at the absolute maximum T_J of 150°C can affect reliability.
- (6) The package thermal impedance is calculated in accordance with JESD 51-7.

Recommended Operating Conditions

		MIN	MAX	UNIT
V _{CC}	Supply voltage (single-supply operation)	2.5	5	V
T _A	Operating free-air temperature	LMV8xxl	125	°C
		LMV8xx	85	

LMV8xx 2.5-V Electrical Characteristics
 $V_{CC+} = 2.5\text{ V}$, $V_{CC-} = 0\text{ V}$, $V_{IC} = 1\text{ V}$, $V_O = 1.25\text{ V}$, and $R_L > 1\text{ M}\Omega$ (unless otherwise noted)

PARAMETER	TEST CONDITIONS	T_A	LMV8xx			UNIT	
			MIN	TYP	MAX		
V_{IO} Input offset voltage		25°C		1	3.5	mV	
		-40°C to 85°C			4		
V_O Output swing	$V_{CC+} = 2.5\text{ V}$, $R_L = 600\ \Omega$ to 1.25 V	High level	25°C	2.3	2.37	V	
			-40°C to 85°C	2.2			
		Low level	25°C		0.13		0.2
			-40°C to 85°C				0.3
	$V_{CC+} = 2.5\text{ V}$, $R_L = 2\text{ k}\Omega$ to 1.25 V	High level	25°C	2.4	2.46		
			-40°C to 85°C	2.3			
		Low level	25°C		0.08		0.12
			-40°C to 85°C				0.2

LMV8xxI 2.5-V Electrical Characteristics
 $V_{CC+} = 2.5\text{ V}$, $V_{CC-} = 0\text{ V}$, $V_{IC} = 1\text{ V}$, $V_O = 1.25\text{ V}$, and $R_L > 1\text{ M}\Omega$ (unless otherwise noted)

PARAMETER	TEST CONDITIONS	T_A	LMV8xxI			UNIT	
			MIN	TYP	MAX		
V_{IO} Input offset voltage		25°C		1	3.5	mV	
		-40°C to 125°C			5.5		
V_O Output swing	$V_{CC+} = 2.5\text{ V}$, $R_L = 600\ \Omega$ to 1.25 V	High level	25°C	2.28	2.37	V	
			-40°C to 125°C	2.18			
		Low level	25°C		0.13		0.22
			-40°C to 125°C				0.32
	$V_{CC+} = 2.5\text{ V}$, $R_L = 2\text{ k}\Omega$ to 1.25 V	High level	25°C	2.38	2.46		
			-40°C to 125°C	2.28			
		Low level	25°C		0.08		0.14
			-40°C to 125°C				0.22

LMV821 SINGLE, LMV822 DUAL, LMV824 QUAD

SLOS434I – FEBRUARY 2004 – REVISED JULY 2006

www.ti.com

LMV8xx 2.7-V Electrical Characteristics

$V_{CC+} = 2.7\text{ V}$, $V_{CC-} = 0\text{ V}$, $V_{IC} = 1\text{ V}$, $V_O = 1.35\text{ V}$, and $R_L > 1\text{ M}\Omega$ (unless otherwise noted)

PARAMETER	TEST CONDITIONS		T_A	LMV8xx			UNIT
				MIN	TYP	MAX	
V_{IO} Input offset voltage			25°C	1	3.5	mV	
			-40°C to 85°C		4		
α_{VIO} Average temperature coefficient of input offset voltage			25°C	1		$\mu\text{V}/^\circ\text{C}$	
I_{IB} Input bias current			25°C	30	90	nA	
			-40°C to 85°C		140		
I_{IO} Input offset current			25°C	0.5	30	nA	
			-40°C to 85°C		50		
CMRR Common-mode rejection ratio	$V_{IC} = 0$ to 1.7 V		25°C	70	85	dB	
			-40°C to 85°C	68			
$+k_{SVR}$ Positive supply-voltage rejection ratio	$V_{CC+} = 1.7\text{ V}$ to 4 V, $V_{CC-} = -1\text{ V}$, $V_O = 0$, $V_{IC} = 0$		25°C	75	85	dB	
			-40°C to 85°C	70			
$-k_{SVR}$ Negative supply-voltage rejection ratio	$V_{CC+} = 1.7\text{ V}$, $V_{CC-} = -1\text{ V}$ to -3.3 V, $V_O = 0$, $V_{IC} = 0$		25°C	73	85	dB	
			-40°C to 85°C	70			
V_{ICR} Common-mode input voltage range	CMRR ≥ 50 dB		25°C	-0.2 to 1.9	-0.3 to 2	V	
A_V Large-signal voltage amplification	$R_L = 600\ \Omega$ to 1.35 V, $V_O = 1.35\text{ V}$ to 2.2 V	Sourcing	25°C	90	100	dB	
			-40°C to 85°C	85			
		Sinking	25°C	85	90		
			-40°C to 85°C	80			
	$R_L = 2\text{ k}\Omega$ to 1.35 V, $V_O = 1.35\text{ V}$ to 2.2 V	Sourcing	25°C	95	100		
			-40°C to 85°C	90			
		Sinking	25°C	90	95		
			-40°C to 85°C	85			
V_O Output swing	$V_{CC+} = 2.7\text{ V}$, $R_L = 600\ \Omega$ to 1.35 V	High level	25°C	2.5	2.58	V	
			-40°C to 85°C	2.4			
		Low level	25°C	0.13	0.2		
			-40°C to 85°C	0.3			
	$V_{CC+} = 2.7\text{ V}$, $R_L = 2\text{ k}\Omega$ to 1.35 V	High level	25°C	2.6	2.66		
			-40°C to 85°C	2.5			
		Low level	25°C	0.08	0.12		
			-40°C to 85°C	0.2			
I_O Output current	$V_O = 0\text{ V}$	Sourcing	25°C	12	16	mA	
	$V_O = 2.7\text{ V}$	Sinking	25°C	12	26		
I_{CC} Supply current	LMV821		25°C	0.22	0.3	mA	
			-40°C to 85°C		0.5		
			25°C	0.45	0.6		
			-40°C to 85°C		0.8		
	LMV824 (all four amplifiers)		25°C	0.72	1		
			-40°C to 85°C		1.2		

LMV8xx 2.7-V Electrical Characteristics (continued)
 $V_{CC+} = 2.7\text{ V}$, $V_{CC-} = 0\text{ V}$, $V_{IC} = 1\text{ V}$, $V_O = 1.35\text{ V}$, and $R_L > 1\text{ M}\Omega$ (unless otherwise noted)

PARAMETER		TEST CONDITIONS	T_A	LMV8xx			UNIT
				MIN	TYP	MAX	
SR	Slew rate ⁽¹⁾		25°C		1.7		V/ μ s
GBW	Gain bandwidth product	⁽²⁾	25°C		5		MHz
Φ_m	Phase margin	⁽²⁾	25°C		60		deg
	Gain margin	⁽²⁾	25°C		8.6		dB
	Amplifier-to-amplifier isolation	$V_{CC+} = 5\text{ V}$, $R_L = 100\text{ k}\Omega$ to 2.5 V ⁽³⁾	25°C		135		dB
V_n	Equivalent input noise voltage	$f = 1\text{ kHz}$, $V_{IC} = 1\text{ V}$	25°C		45		nV/ $\sqrt{\text{Hz}}$
I_n	Equivalent input noise current	$f = 1\text{ kHz}$	25°C		0.18		pA/ $\sqrt{\text{Hz}}$
THD	Total harmonic distortion	$f = 1\text{ kHz}$, $A_V = -2$, $R_L = 10\text{ k}\Omega$, $V_O = 4.1\text{ V}_{p-p}$	25°C		0.01		%

(1) Connected as voltage follower with 1-V step input. Value specified is the slower of the positive and negative slew rates.

(2) 40-dB closed-loop dc gain, $C_L = 22\text{ pF}$

(3) Each amplifier excited in turn with 1 kHz to produce $V_O = 3\text{ V}_{p-p}$

LMV821 SINGLE, LMV822 DUAL, LMV824 QUAD

SLOS434I – FEBRUARY 2004 – REVISED JULY 2006

www.ti.com

LMV8xxI 2.7-V Electrical Characteristics

$V_{CC+} = 2.7\text{ V}$, $V_{CC-} = 0\text{ V}$, $V_{IC} = 1\text{ V}$, $V_O = 1.35\text{ V}$, and $R_L > 1\text{ M}\Omega$ (unless otherwise noted)

PARAMETER	TEST CONDITIONS		T_A	LMV8xxI			UNIT
				MIN	TYP	MAX	
V_{IO} Input offset voltage			25°C	1	3.5	mV	
			-40°C to 125°C		5.5		
α_{VIO} Average temperature coefficient of input offset voltage			25°C	1		$\mu\text{V}/^\circ\text{C}$	
I_{IB} Input bias current			25°C	30	90	nA	
			-40°C to 125°C		140		
I_{IO} Input offset current			25°C	0.5	30	nA	
			-40°C to 125°C		50		
CMRR Common-mode rejection ratio	$V_{IC} = 0\text{ to }1.7\text{ V}$		25°C	70	85	dB	
			-40°C to 125°C	68			
+ k_{SVR} Positive supply-voltage rejection ratio	$V_{CC+} = 1.7\text{ V to }4\text{ V}$, $V_{CC-} = -1\text{ V}$, $V_O = 0$, $V_{IC} = 0$		25°C	75	85	dB	
			-40°C to 125°C	70			
- k_{SVR} Negative supply-voltage rejection ratio	$V_{CC+} = 1.7\text{ V}$, $V_{CC-} = -1\text{ V to }-3.3\text{ V}$, $V_O = 0$, $V_{IC} = 0$		25°C	73	85	dB	
			-40°C to 125°C	70			
V_{ICR} Common-mode input voltage range	CMRR $\geq 50\text{ dB}$		25°C	-0.2 to 1.9	-0.3 to 2	V	
A_V Large-signal voltage amplification	$R_L = 600\ \Omega\text{ to }1.35\text{ V}$, $V_O = 1.35\text{ V to }2.2\text{ V}$	Sourcing	25°C	90	100	dB	
			-40°C to 125°C	85			
		Sinking	25°C	85	90		
			-40°C to 125°C	80			
	$R_L = 2\text{ k}\Omega\text{ to }1.35\text{ V}$, $V_O = 1.35\text{ V to }2.2\text{ V}$	Sourcing	25°C	95	100		
			-40°C to 125°C	90			
		Sinking	25°C	90	95		
			-40°C to 125°C	85			
V_O Output swing	$V_{CC+} = 2.7\text{ V}$, $R_L = 600\ \Omega\text{ to }1.35\text{ V}$	High level	25°C	2.5	2.58	V	
			-40°C to 125°C	2.4			
		Low level	25°C	0.13	0.2		
			-40°C to 125°C	0.3			
	$V_{CC+} = 2.7\text{ V}$, $R_L = 2\text{ k}\Omega\text{ to }1.35\text{ V}$	High level	25°C	2.6	2.66		
			-40°C to 125°C	2.5			
		Low level	25°C	0.08	0.12		
			-40°C to 125°C	0.2			
I_O Output current	$V_O = 0\text{ V}$	Sourcing	25°C	12	16	mA	
	$V_O = 2.7\text{ V}$	Sinking	25°C	12	26		
I_{CC} Supply current	LMV821		25°C	0.22	0.3	mA	
			-40°C to 125°C		0.5		
	LMV822 (both amplifiers)		25°C	0.45	0.6		
			-40°C to 125°C		0.8		
	LMV824 (all four amplifiers)		25°C	0.72	1		
			-40°C to 125°C		1.2		

LMV8xxI 2.7-V Electrical Characteristics (continued)
 $V_{CC+} = 2.7\text{ V}$, $V_{CC-} = 0\text{ V}$, $V_{IC} = 1\text{ V}$, $V_O = 1.35\text{ V}$, and $R_L > 1\text{ M}\Omega$ (unless otherwise noted)

PARAMETER		TEST CONDITIONS	T_A	LMV8xxI			UNIT
				MIN	TYP	MAX	
SR	Slew rate ⁽¹⁾		25°C		1.7		V/ μ s
GBW	Gain bandwidth product	⁽²⁾	25°C		5		MHz
Φ_m	Phase margin	⁽²⁾	25°C		60		deg
	Gain margin	⁽²⁾	25°C		8.6		dB
	Amplifier-to-amplifier isolation	$V_{CC+} = 5\text{ V}$, $R_L = 100\text{ k}\Omega$ to 2.5 V ⁽³⁾	25°C		135		dB
V_n	Equivalent input noise voltage	$f = 1\text{ kHz}$, $V_{IC} = 1\text{ V}$	25°C		45		nV/ $\sqrt{\text{Hz}}$
I_n	Equivalent input noise current	$f = 1\text{ kHz}$	25°C		0.18		pA/ $\sqrt{\text{Hz}}$
THD	Total harmonic distortion	$f = 1\text{ kHz}$, $A_V = -2$, $R_L = 10\text{ k}\Omega$, $V_O = 4.1\text{ V}_{p-p}$	25°C		0.01		%

(1) Connected as voltage follower with 1-V step input. Value specified is the slower of the positive and negative slew rates.

(2) 40-dB closed-loop dc gain, $C_L = 22\text{ pF}$

(3) Each amplifier excited in turn with 1 kHz to produce $V_O = 3\text{ V}_{p-p}$

LMV821 SINGLE, LMV822 DUAL, LMV824 QUAD

SLOS434I – FEBRUARY 2004 – REVISED JULY 2006

www.ti.com

LMV8xx 5-V Electrical Characteristics

$V_{CC+} = 5\text{ V}$, $V_{CC-} = 0\text{ V}$, $V_{IC} = 2\text{ V}$, $V_O = 2.5\text{ V}$, and $R_L > 1\text{ M}\Omega$ (unless otherwise noted)

PARAMETER	TEST CONDITIONS		T_A	LMV8xx			UNIT
				MIN	TYP	MAX	
V_{IO} Input offset voltage			25°C	1	3.5	mV	
			-40°C to 85°C		4		
α_{VIO} Average temperature coefficient of input offset voltage			25°C	1		$\mu\text{V}/^\circ\text{C}$	
I_{IB} Input bias current			25°C	40	100	nA	
			-40°C to 85°C		150		
I_{IO} Input offset current			25°C	0.5	30	nA	
			-40°C to 85°C		50		
CMRR Common-mode rejection ratio	$V_{IC} = 0\text{ to }4\text{ V}$		25°C	72	90	dB	
			-40°C to 85°C	70			
$+k_{SVR}$ Positive supply-voltage rejection ratio	$V_{CC+} = 1.7\text{ V to }4\text{ V}$, $V_{CC-} = -1\text{ V}$, $V_O = 0$, $V_{IC} = 0$		25°C	75	85	dB	
			-40°C to 85°C	70			
$-k_{SVR}$ Negative supply-voltage rejection ratio	$V_{CC+} = 1.7\text{ V}$, $V_{CC-} = -1\text{ V to }-3.3\text{ V}$, $V_O = 0$, $V_{IC} = 0$		25°C	73	85	dB	
			-40°C to 85°C	70			
V_{ICR} Common-mode input voltage range	CMRR $\geq 50\text{ dB}$		25°C	-0.2 to 4.2	-0.3 to 4.3	V	
A_V Large-signal voltage amplification	$R_L = 600\ \Omega\text{ to }2.5\text{ V}$, $V_O = 2.5\text{ V to }4.5\text{ V}$	Sourcing	25°C	95	105	dB	
			-40°C to 85°C	90			
	$R_L = 600\ \Omega\text{ to }2.5\text{ V}$, $V_O = 2.5\text{ V to }0.5\text{ V}$	Sinking	25°C	95	105		
			-40°C to 85°C	90			
$R_L = 2\text{ k}\Omega\text{ to }2.5\text{ V}$, $V_O = 2.5\text{ V to }4.5\text{ V}$	Sourcing	25°C	95	105			
		-40°C to 85°C	90				
$R_L = 2\text{ k}\Omega\text{ to }2.5\text{ V}$, $V_O = 2.5\text{ V to }0.5\text{ V}$	Sinking	25°C	95	105			
		-40°C to 85°C	90				
V_O Output swing	$V_{CC+} = 5\text{ V}$, $R_L = 600\ \Omega\text{ to }2.5\text{ V}$	High level	25°C	4.75	4.84	V	
			-40°C to 85°C	4.7			
		Low level	25°C	0.17	0.25		
		-40°C to 85°C	0.3				
	$V_{CC+} = 5\text{ V}$, $R_L = 2\text{ k}\Omega\text{ to }2.5\text{ V}$	High level	25°C	4.85	4.9		
			-40°C to 85°C	4.8			
Low level		25°C	0.1	0.15			
	-40°C to 85°C	0.2					
I_O Output current	$V_O = 0\text{ V}$	Sourcing	25°C	20	45	mA	
			-40°C to 85°C	15			
	$V_O = 5\text{ V}$	Sinking	25°C	20	40		
			-40°C to 85°C	15			
I_{CC} Supply current	LMV821		25°C	0.3	0.4	mA	
			-40°C to 85°C		0.6		
	LMV822 (both amplifiers)		25°C	0.5	0.7		
			-40°C to 85°C		0.9		
	LMV824 (all four amplifiers)		25°C	1	1.3		
			-40°C to 85°C		1.5		

LMV8xx 5-V Electrical Characteristics (continued)
 $V_{CC+} = 5\text{ V}$, $V_{CC-} = 0\text{ V}$, $V_{IC} = 2\text{ V}$, $V_O = 2.5\text{ V}$, and $R_L > 1\text{ M}\Omega$ (unless otherwise noted)

PARAMETER		TEST CONDITIONS	T_A	LMV8xx			UNIT
				MIN	TYP	MAX	
SR	Slew rate	$V_{CC+} = 5\text{ V}^{(1)}$	25°C	1.4	1.9		V/ μ s
GBW	Gain bandwidth product	⁽²⁾	25°C		5.5		MHz
Φ_m	Phase margin	⁽²⁾	25°C		64.2		deg
	Gain margin	⁽²⁾	25°C		8.7		dB
	Amplifier-to-amplifier isolation	$V_{CC+} = 5\text{ V}$, $R_L = 100\text{ k}\Omega$ to $2.5\text{ V}^{(3)}$	25°C		135		dB
V_n	Equivalent input noise voltage	$f = 1\text{ kHz}$, $V_{IC} = 1\text{ V}$	25°C		42		nV/ $\sqrt{\text{Hz}}$
I_n	Equivalent input noise current	$f = 1\text{ kHz}$	25°C		0.2		pA/ $\sqrt{\text{Hz}}$
THD	Total harmonic distortion	$f = 1\text{ kHz}$, $A_V = -2$, $R_L = 10\text{ k}\Omega$, $V_O = 4.1\text{ V}_{p-p}$	25°C		0.01		%

(1) Connected as voltage follower with 3-V step input. Value specified is the slower of the positive and negative slew rates.

(2) 40-dB closed-loop dc gain, $C_L = 22\text{ pF}$

(3) Each amplifier excited in turn with 1 kHz to produce $V_O = 3\text{ V}_{p-p}$

LMV821 SINGLE, LMV822 DUAL, LMV824 QUAD

SLOS434I – FEBRUARY 2004 – REVISED JULY 2006

www.ti.com

LMV8xxI 5-V Electrical Characteristics

$V_{CC+} = 5\text{ V}$, $V_{CC-} = 0\text{ V}$, $V_{IC} = 2\text{ V}$, $V_O = 2.5\text{ V}$, and $R_L > 1\text{ M}\Omega$ (unless otherwise noted)

PARAMETER	TEST CONDITIONS		T_A	LMV8xxI			UNIT
				MIN	TYP	MAX	
V_{IO} Input offset voltage			25°C	1	3.5	mV	
			-40°C to 125°C		5.5		
α_{VIO} Average temperature coefficient of input offset voltage			25°C	1		$\mu\text{V}/^\circ\text{C}$	
I_{IB} Input bias current			25°C	40	100	nA	
			-40°C to 125°C		150		
I_{IO} Input offset current			25°C	0.5	30	nA	
			-40°C to 125°C		50		
CMRR Common-mode rejection ratio	$V_{IC} = 0\text{ to }4\text{ V}$		25°C	72	90	dB	
			-40°C to 125°C	70			
$+k_{SVR}$ Positive supply-voltage rejection ratio	$V_{CC+} = 1.7\text{ V to }4\text{ V}$, $V_{CC-} = -1\text{ V}$, $V_O = 0$, $V_{IC} = 0$		25°C	75	85	dB	
			-40°C to 125°C	70			
$-k_{SVR}$ Negative supply-voltage rejection ratio	$V_{CC+} = 1.7\text{ V}$, $V_{CC-} = -1\text{ V to }-3.3\text{ V}$, $V_O = 0$, $V_{IC} = 0$		25°C	73	85	dB	
			-40°C to 125°C	70			
V_{ICR} Common-mode input voltage range	CMRR $\geq 50\text{ dB}$		25°C	-0.2 to 4.2	-0.3 to 4.3	V	
A_V Large-signal voltage amplification	$R_L = 600\ \Omega\text{ to }2.5\text{ V}$, $V_O = 2.5\text{ V to }4.5\text{ V}$	Sourcing	25°C	95	105	dB	
			-40°C to 125°C	90			
		Sinking	25°C	95	105		
			-40°C to 125°C	90			
	$R_L = 2\text{ k}\Omega\text{ to }2.5\text{ V}$, $V_O = 2.5\text{ V to }4.5\text{ V}$	Sourcing	25°C	95	105		
			-40°C to 125°C	90			
		Sinking	25°C	95	105		
			-40°C to 125°C	90			
V_O Output swing	$V_{CC+} = 5\text{ V}$, $R_L = 600\ \Omega\text{ to }2.5\text{ V}$	High level	25°C	4.75	4.84	V	
			-40°C to 125°C	4.6			
		Low level	25°C	0.17	0.25		
			-40°C to 125°C	0.3			
	$V_{CC+} = 5\text{ V}$, $R_L = 2\text{ k}\Omega\text{ to }2.5\text{ V}$	High level	25°C	4.85	4.9		
			-40°C to 125°C	4.8			
		Low level	25°C	0.1	0.15		
			-40°C to 125°C	0.2			
I_O Output current	$V_O = 0\text{ V}$	Sourcing	25°C	20	45	mA	
			-40°C to 125°C	15			
	$V_O = 5\text{ V}$	Sinking	25°C	20	40		
			-40°C to 125°C	15			
I_{CC} Supply current	LMV821		25°C	0.3	0.4	mA	
			-40°C to 125°C		0.6		
	LMV822 (both amplifiers)		25°C	0.5	0.7		
			-40°C to 125°C		0.9		
	LMV824 (all four amplifiers)		25°C	1	1.3		
			-40°C to 125°C		1.5		

LMV8xxI 5-V Electrical Characteristics (continued)
 $V_{CC+} = 5\text{ V}$, $V_{CC-} = 0\text{ V}$, $V_{IC} = 2\text{ V}$, $V_O = 2.5\text{ V}$, and $R_L > 1\text{ M}\Omega$ (unless otherwise noted)

PARAMETER		TEST CONDITIONS	T_A	LMV8xxI			UNIT
				MIN	TYP	MAX	
SR	Slew rate	$V_{CC+} = 5\text{ V}^{(1)}$	25°C	1.4	1.9		V/ μ s
GBW	Gain bandwidth product	⁽²⁾	25°C		5.5		MHz
Φ_m	Phase margin	⁽²⁾	25°C		64.2		deg
	Gain margin	⁽²⁾	25°C		8.7		dB
	Amplifier-to-amplifier isolation	$V_{CC+} = 5\text{ V}$, $R_L = 100\text{ k}\Omega$ to $2.5\text{ V}^{(3)}$	25°C		135		dB
V_n	Equivalent input noise voltage	$f = 1\text{ kHz}$, $V_{IC} = 1\text{ V}$	25°C		42		nV/ $\sqrt{\text{Hz}}$
I_n	Equivalent input noise current	$f = 1\text{ kHz}$	25°C		0.2		pA/ $\sqrt{\text{Hz}}$
THD	Total harmonic distortion	$f = 1\text{ kHz}$, $A_V = -2$, $R_L = 10\text{ k}\Omega$, $V_O = 4.1\text{ V}_{p-p}$	25°C		0.01		%

- (1) Connected as voltage follower with 3-V step input. Value specified is the slower of the positive and negative slew rates.
- (2) 40-dB closed-loop dc gain, $C_L = 22\text{ pF}$
- (3) Each amplifier excited in turn with 1 kHz to produce $V_O = 3\text{ V}_{p-p}$

TYPICAL CHARACTERISTICS

$T_A = 25^\circ\text{C}$, $V_{CC+} = 5\text{-V}$ Single Supply (Unless Otherwise Noted)

SUPPLY CURRENT
vs
SUPPLY VOLTAGE



Figure 3.

INPUT CURRENT
vs
TEMPERATURE

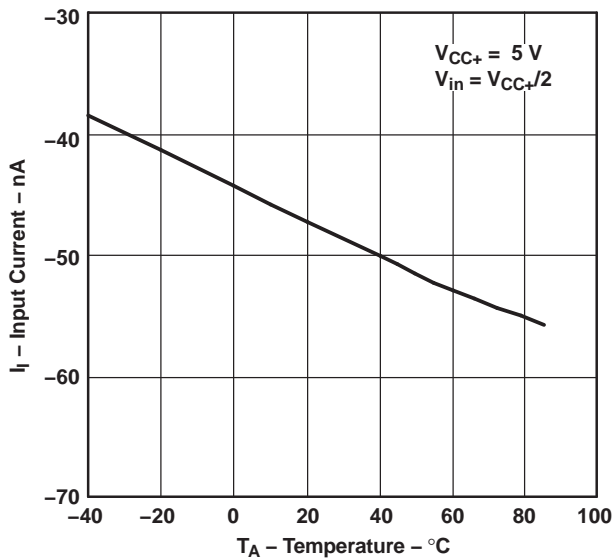

Figure 4.

SOURCING CURRENT
vs
OUTPUT VOLTAGE



Figure 5.

SOURCING CURRENT
vs
OUTPUT VOLTAGE

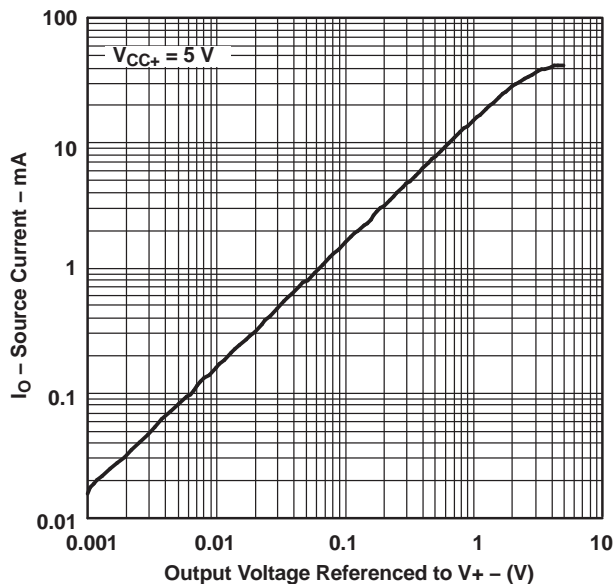

Figure 6.

TYPICAL CHARACTERISTICS (continued)

T_A = 25°C, V_{CC+} = 5-V Single Supply (Unless Otherwise Noted)

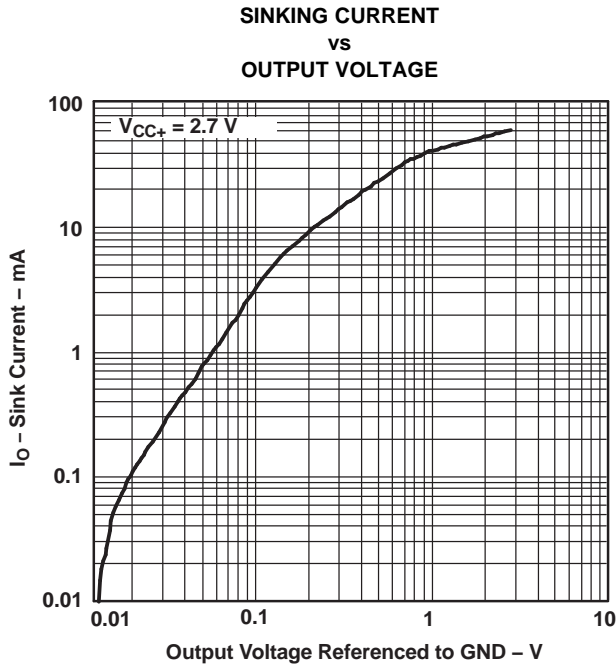

Figure 7.

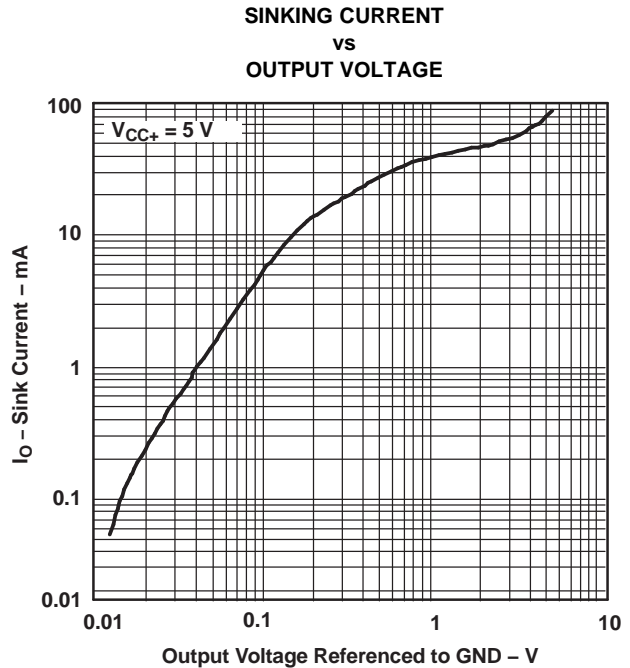

Figure 8.

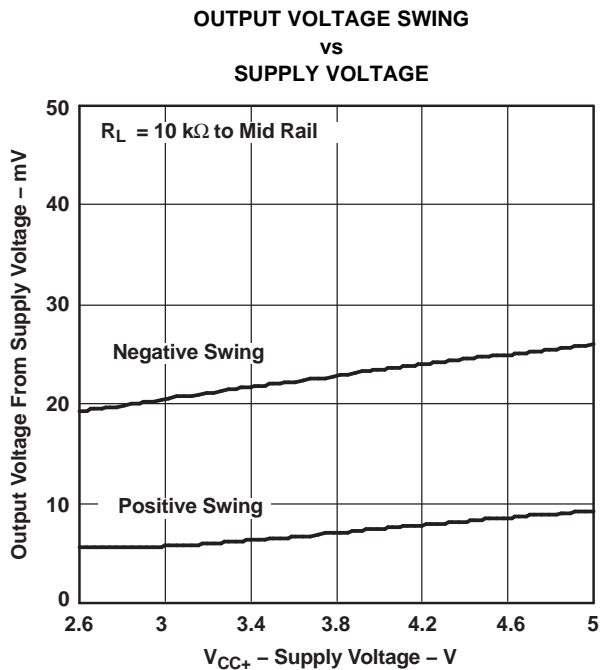

Figure 9.

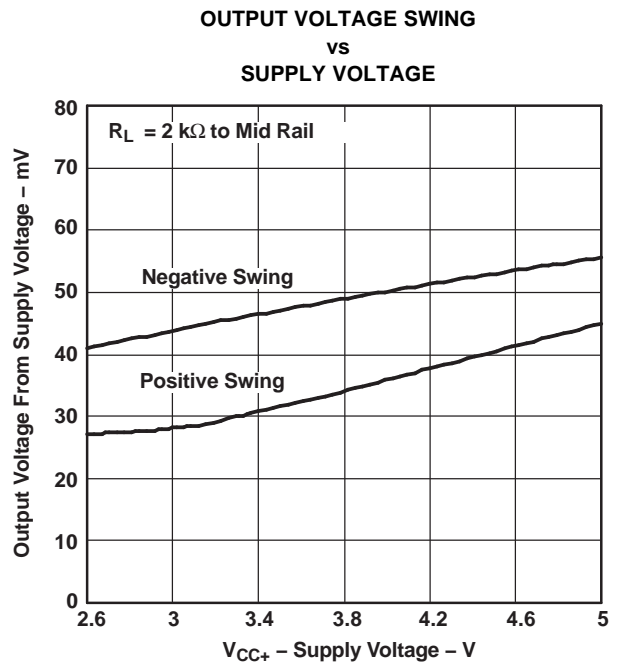

Figure 10.

LMV821 SINGLE, LMV822 DUAL, LMV824 QUAD

SLOS434I – FEBRUARY 2004 – REVISED JULY 2006

www.ti.com

TYPICAL CHARACTERISTICS (continued)

$T_A = 25^\circ\text{C}$, $V_{CC+} = 5\text{-V}$ Single Supply (Unless Otherwise Noted)

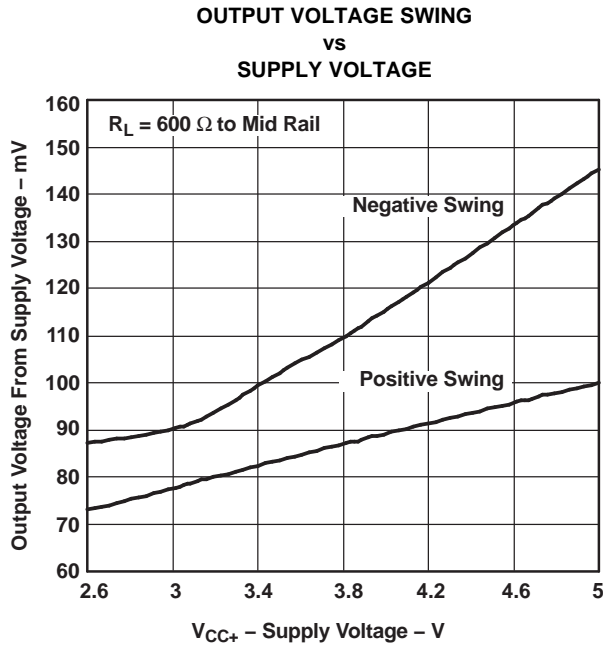

Figure 11.

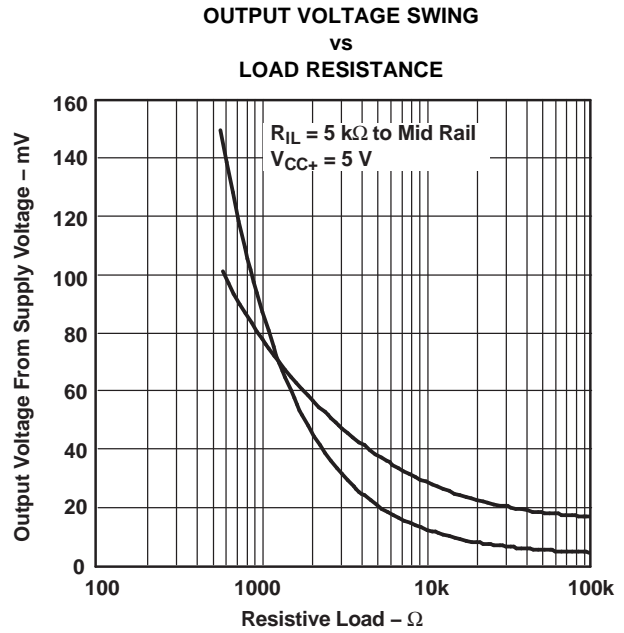

Figure 12.

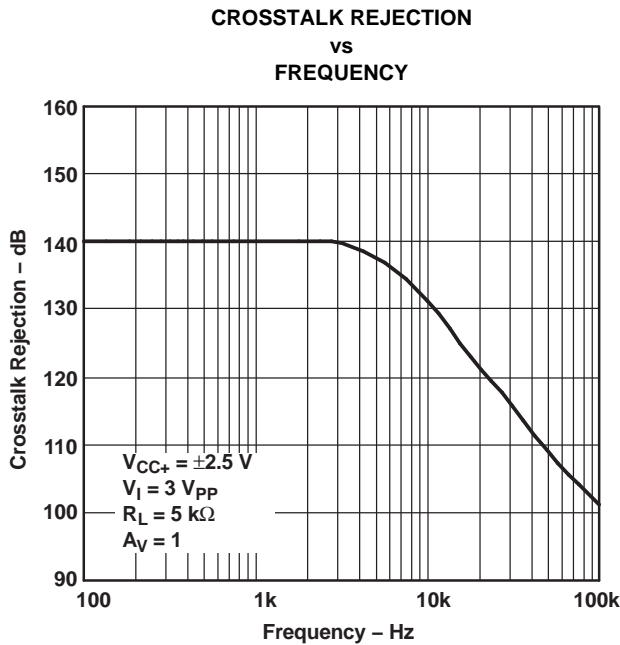

Figure 13.

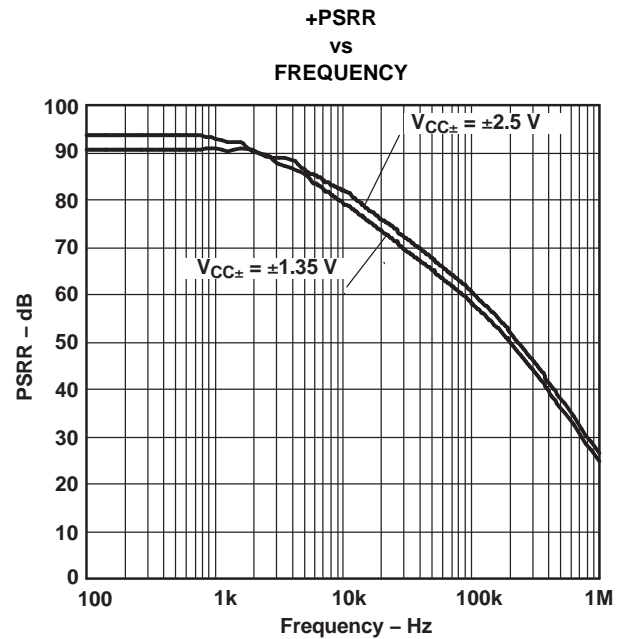

Figure 14.

TYPICAL CHARACTERISTICS (continued)

$T_A = 25^\circ\text{C}$, $V_{CC+} = 5\text{-V}$ Single Supply (Unless Otherwise Noted)



Figure 15.

GAIN AND PHASE MARGIN
vs
FREQUENCY
($V_{CC+} = 2.7\text{ V}$, $R_L = 600\ \Omega$, $2\text{ k}\Omega$, $100\text{ k}\Omega$)

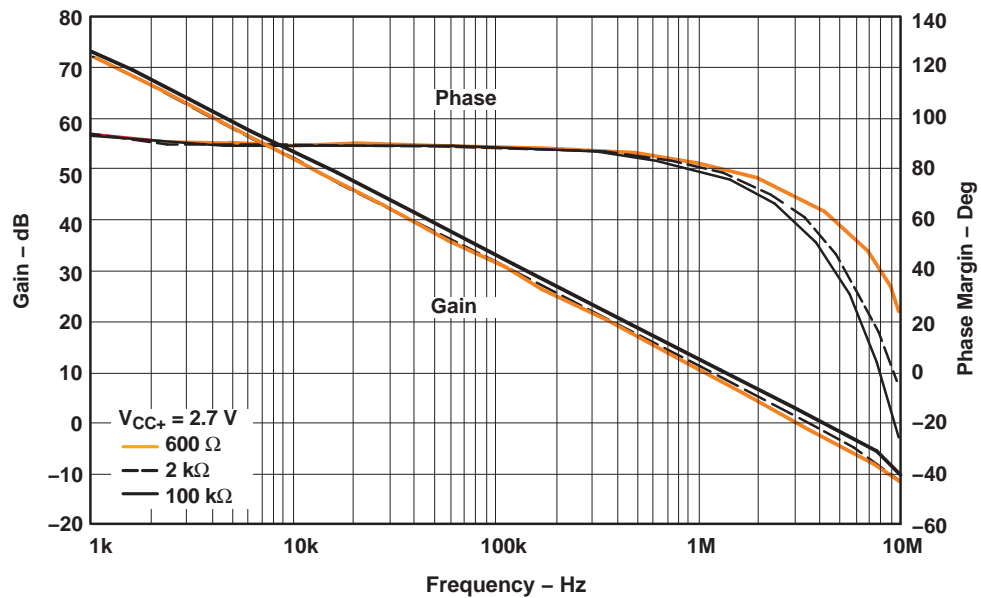

Figure 16.

TYPICAL CHARACTERISTICS (continued)

$T_A = 25^\circ\text{C}$, $V_{CC+} = 5\text{-V}$ Single Supply (Unless Otherwise Noted)

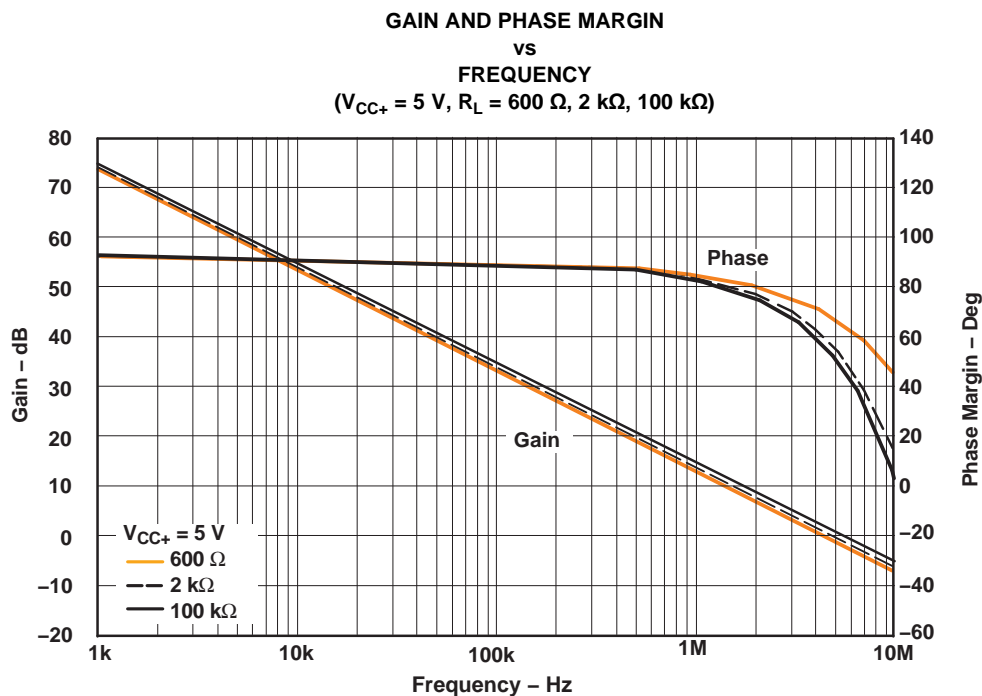

Figure 17.

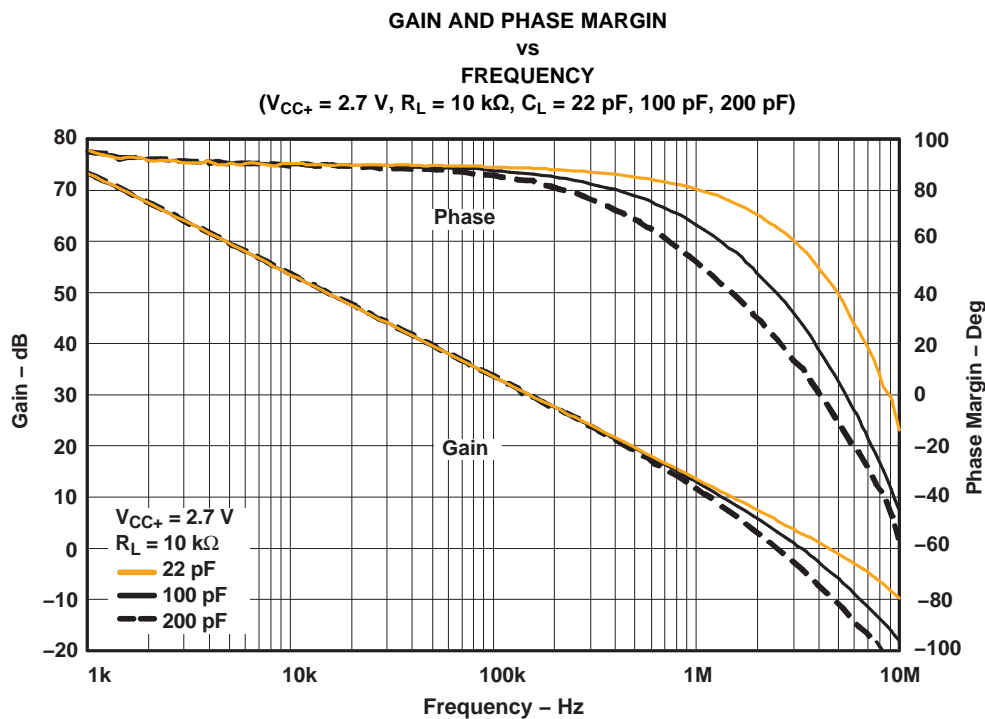

Figure 18.

TYPICAL CHARACTERISTICS (continued)

T_A = 25°C, V_{CC+} = 5-V Single Supply (Unless Otherwise Noted)



Figure 19.

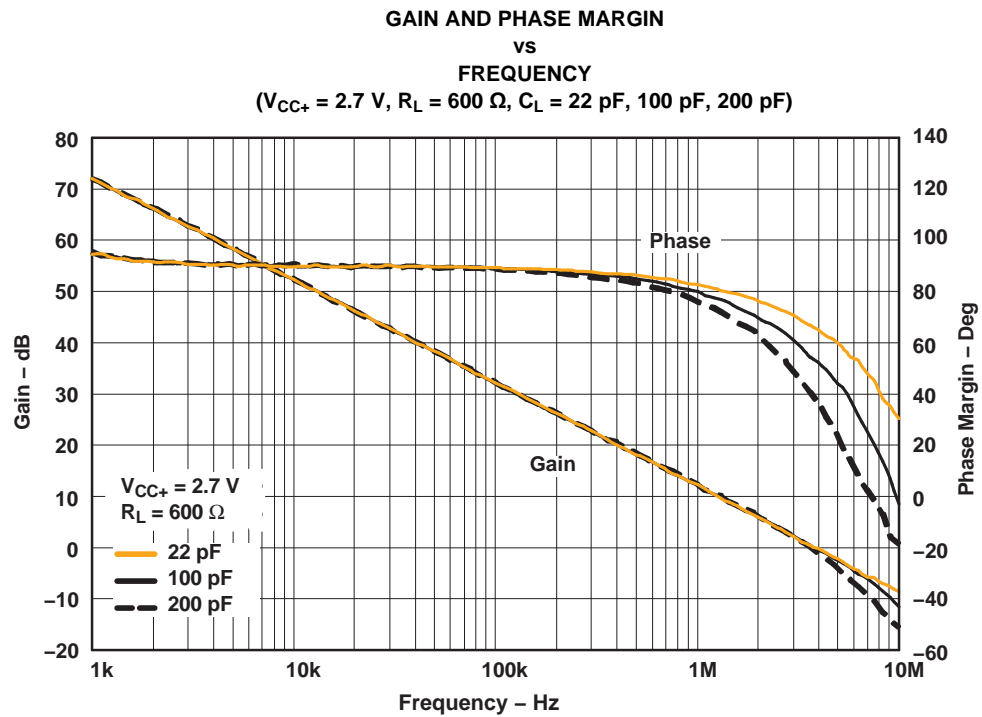

Figure 20.

LMV821 SINGLE, LMV822 DUAL, LMV824 QUAD

SLOS434I – FEBRUARY 2004 – REVISED JULY 2006

www.ti.com

TYPICAL CHARACTERISTICS (continued)

$T_A = 25^\circ\text{C}$, $V_{CC+} = 5\text{-V}$ Single Supply (Unless Otherwise Noted)



Figure 21.

PACKAGING INFORMATION

Orderable Device	Status (1)	Package Type	Package Drawing	Pins	Package Qty	Eco Plan (2)	Lead/Ball Finish (6)	MSL Peak Temp (3)	Op Temp (°C)	Device Marking (4/5)	Samples
LMV821DBVR	OBSOLETE	SOT-23	DBV	5		TBD	Call TI	Call TI	-40 to 85	(RB8B ~ RB8C ~ RB8I)	
LMV821DBVRE4	OBSOLETE	SOT-23	DBV	5		TBD	Call TI	Call TI	-40 to 85		
LMV821DBVRG4	OBSOLETE	SOT-23	DBV	5		TBD	Call TI	Call TI	-40 to 85		
LMV821DBVT	OBSOLETE	SOT-23	DBV	5		TBD	Call TI	Call TI	-40 to 85	(RB8B ~ RB8C ~ RB8I)	
LMV821DBVTE4	OBSOLETE	SOT-23	DBV	5		TBD	Call TI	Call TI	-40 to 85		
LMV821DBVTG4	OBSOLETE	SOT-23	DBV	5		TBD	Call TI	Call TI	-40 to 85		
LMV821DCKR	OBSOLETE	SC70	DCK	5		TBD	Call TI	Call TI	-40 to 85	(RYB ~ RYC ~ RYI)	
LMV821DCKRE4	OBSOLETE	SC70	DCK	5		TBD	Call TI	Call TI	-40 to 85		
LMV821DCKRG4	OBSOLETE	SC70	DCK	5		TBD	Call TI	Call TI	-40 to 85		
LMV821DCKT	OBSOLETE	SC70	DCK	5		TBD	Call TI	Call TI	-40 to 85	(RYB ~ RYI)	
LMV821DCKTE4	OBSOLETE	SC70	DCK	5		TBD	Call TI	Call TI	-40 to 85		
LMV821DCKTG4	OBSOLETE	SC70	DCK	5		TBD	Call TI	Call TI	-40 to 85		
LMV821IDBVR	OBSOLETE	SOT-23	DBV	5		TBD	Call TI	Call TI	-40 to 125	RB1B	
LMV821IDBVRE4	OBSOLETE	SOT-23	DBV	5		TBD	Call TI	Call TI	-40 to 125		
LMV821IDBVRG4	OBSOLETE	SOT-23	DBV	5		TBD	Call TI	Call TI	-40 to 125		
LMV821IDBVT	OBSOLETE	SOT-23	DBV	5		TBD	Call TI	Call TI	-40 to 125	RB1B	
LMV821IDBVTE4	OBSOLETE	SOT-23	DBV	5		TBD	Call TI	Call TI	-40 to 125		
LMV821IDBVTG4	OBSOLETE	SOT-23	DBV	5		TBD	Call TI	Call TI	-40 to 125		
LMV821IDCKR	OBSOLETE	SC70	DCK	5		TBD	Call TI	Call TI	-40 to 125	(RZB ~ RZI)	
LMV821IDCKRE4	OBSOLETE	SC70	DCK	5		TBD	Call TI	Call TI	-40 to 125		
LMV821IDCKRG4	OBSOLETE	SC70	DCK	5		TBD	Call TI	Call TI	-40 to 125		
LMV821IDCKT	OBSOLETE	SC70	DCK	5		TBD	Call TI	Call TI	-40 to 125	(RZB ~ RZI)	
LMV821IDCKTE4	OBSOLETE	SC70	DCK	5		TBD	Call TI	Call TI	-40 to 125		
LMV821IDCKTG4	OBSOLETE	SC70	DCK	5		TBD	Call TI	Call TI	-40 to 125		
LMV822D	OBSOLETE	SOIC	D	8		TBD	Call TI	Call TI	-40 to 85	MV822	
LMV822DE4	OBSOLETE	SOIC	D	8		TBD	Call TI	Call TI	-40 to 85		
LMV822DG4	OBSOLETE	SOIC	D	8		TBD	Call TI	Call TI	-40 to 85		
LMV822DGKR	OBSOLETE	VSSOP	DGK	8		TBD	Call TI	Call TI	-40 to 85	(RAB ~ RAC)	

Orderable Device	Status (1)	Package Type	Package Drawing	Pins	Package Qty	Eco Plan (2)	Lead/Ball Finish (6)	MSL Peak Temp (3)	Op Temp (°C)	Device Marking (4/5)	Samples
LMV822DGKRG4	OBSOLETE	VSSOP	DGK	8		TBD	Call TI	Call TI	-40 to 85		
LMV822DR	OBSOLETE	SOIC	D	8		TBD	Call TI	Call TI	-40 to 85	MV822	
LMV822DRE4	OBSOLETE	SOIC	D	8		TBD	Call TI	Call TI	-40 to 85		
LMV822DRG4	OBSOLETE	SOIC	D	8		TBD	Call TI	Call TI	-40 to 85		
LMV822ID	OBSOLETE	SOIC	D	8		TBD	Call TI	Call TI	-40 to 125	MV822I	
LMV822IDE4	OBSOLETE	SOIC	D	8		TBD	Call TI	Call TI	-40 to 125		
LMV822IDG4	OBSOLETE	SOIC	D	8		TBD	Call TI	Call TI	-40 to 125		
LMV822IDGKR	OBSOLETE	VSSOP	DGK	8		TBD	Call TI	Call TI	-40 to 125	(R8B ~ R8C)	
LMV822IDGKRG4	OBSOLETE	VSSOP	DGK	8		TBD	Call TI	Call TI	-40 to 125		
LMV822IDR	OBSOLETE	SOIC	D	8		TBD	Call TI	Call TI	-40 to 125	MV822I	
LMV822IDRE4	OBSOLETE	SOIC	D	8		TBD	Call TI	Call TI	-40 to 125		
LMV822IDRG4	OBSOLETE	SOIC	D	8		TBD	Call TI	Call TI	-40 to 125		
LMV824D	OBSOLETE	SOIC	D	14		TBD	Call TI	Call TI	-40 to 85	LMV824	
LMV824DE4	OBSOLETE	SOIC	D	14		TBD	Call TI	Call TI	-40 to 85		
LMV824DG4	OBSOLETE	SOIC	D	14		TBD	Call TI	Call TI	-40 to 85		
LMV824DGVR	OBSOLETE	TVSOP	DGV	14		TBD	Call TI	Call TI	-40 to 85	MV824	
LMV824DGVRE4	OBSOLETE	TVSOP	DGV	14		TBD	Call TI	Call TI	-40 to 85		
LMV824DGVRG4	OBSOLETE	TVSOP	DGV	14		TBD	Call TI	Call TI	-40 to 85		
LMV824DR	OBSOLETE	SOIC	D	14		TBD	Call TI	Call TI	-40 to 85	LMV824	
LMV824DRE4	OBSOLETE	SOIC	D	14		TBD	Call TI	Call TI	-40 to 85		
LMV824DRG4	OBSOLETE	SOIC	D	14		TBD	Call TI	Call TI	-40 to 85		
LMV824ID	OBSOLETE	SOIC	D	14		TBD	Call TI	Call TI	-40 to 125	LMV824I	
LMV824IDE4	OBSOLETE	SOIC	D	14		TBD	Call TI	Call TI	-40 to 125		
LMV824IDG4	OBSOLETE	SOIC	D	14		TBD	Call TI	Call TI	-40 to 125		
LMV824IDGVR	OBSOLETE	TVSOP	DGV	14		TBD	Call TI	Call TI	-40 to 125	MV824I	
LMV824IDGVRE4	OBSOLETE	TVSOP	DGV	14		TBD	Call TI	Call TI	-40 to 125		
LMV824IDGVRG4	OBSOLETE	TVSOP	DGV	14		TBD	Call TI	Call TI	-40 to 125		
LMV824IDR	OBSOLETE	SOIC	D	14		TBD	Call TI	Call TI	-40 to 125	LMV824I	
LMV824IDRE4	OBSOLETE	SOIC	D	14		TBD	Call TI	Call TI	-40 to 125		
LMV824IDRG4	OBSOLETE	SOIC	D	14		TBD	Call TI	Call TI	-40 to 125		
LMV824IPW	OBSOLETE	TSSOP	PW	14		TBD	Call TI	Call TI	-40 to 125	MV824I	

Orderable Device	Status (1)	Package Type	Package Drawing	Pins	Package Qty	Eco Plan (2)	Lead/Ball Finish (6)	MSL Peak Temp (3)	Op Temp (°C)	Device Marking (4/5)	Samples
LMV824IPWE4	OBSOLETE	TSSOP	PW	14		TBD	Call TI	Call TI	-40 to 125		
LMV824IPWG4	OBSOLETE	TSSOP	PW	14		TBD	Call TI	Call TI	-40 to 125		
LMV824IPWR	OBSOLETE	TSSOP	PW	14		TBD	Call TI	Call TI	-40 to 125	MV824I	
LMV824IPWRE4	NRND	TSSOP	PW	14		TBD	Call TI	Call TI	-40 to 125		
LMV824IPWRG4	OBSOLETE	TSSOP	PW	14		TBD	Call TI	Call TI	-40 to 125		
LMV824PW	OBSOLETE	TSSOP	PW	14		TBD	Call TI	Call TI	-40 to 85	MV824	
LMV824PWE4	OBSOLETE	TSSOP	PW	14		TBD	Call TI	Call TI	-40 to 85		
LMV824PWG4	OBSOLETE	TSSOP	PW	14		TBD	Call TI	Call TI	-40 to 85		
LMV824PWR	OBSOLETE	TSSOP	PW	14		TBD	Call TI	Call TI	-40 to 85	MV824	
LMV824PWRE4	OBSOLETE	TSSOP	PW	14		TBD	Call TI	Call TI	-40 to 85		
LMV824PWRG4	OBSOLETE	TSSOP	PW	14		TBD	Call TI	Call TI	-40 to 85		

(1) The marketing status values are defined as follows:

ACTIVE: Product device recommended for new designs.

LIFEBUY: TI has announced that the device will be discontinued, and a lifetime-buy period is in effect.

NRND: Not recommended for new designs. Device is in production to support existing customers, but TI does not recommend using this part in a new design.

PREVIEW: Device has been announced but is not in production. Samples may or may not be available.

OBSOLETE: TI has discontinued the production of the device.

(2) Eco Plan - The planned eco-friendly classification: Pb-Free (RoHS), Pb-Free (RoHS Exempt), or Green (RoHS & no Sb/Br) - please check <http://www.ti.com/productcontent> for the latest availability information and additional product content details.

TBD: The Pb-Free/Green conversion plan has not been defined.

Pb-Free (RoHS): TI's terms "Lead-Free" or "Pb-Free" mean semiconductor products that are compatible with the current RoHS requirements for all 6 substances, including the requirement that lead not exceed 0.1% by weight in homogeneous materials. Where designed to be soldered at high temperatures, TI Pb-Free products are suitable for use in specified lead-free processes.

Pb-Free (RoHS Exempt): This component has a RoHS exemption for either 1) lead-based flip-chip solder bumps used between the die and package, or 2) lead-based die adhesive used between the die and leadframe. The component is otherwise considered Pb-Free (RoHS compatible) as defined above.

Green (RoHS & no Sb/Br): TI defines "Green" to mean Pb-Free (RoHS compatible), and free of Bromine (Br) and Antimony (Sb) based flame retardants (Br or Sb do not exceed 0.1% by weight in homogeneous material)

(3) MSL, Peak Temp. - The Moisture Sensitivity Level rating according to the JEDEC industry standard classifications, and peak solder temperature.

(4) There may be additional marking, which relates to the logo, the lot trace code information, or the environmental category on the device.

(5) Multiple Device Markings will be inside parentheses. Only one Device Marking contained in parentheses and separated by a "~" will appear on a device. If a line is indented then it is a continuation of the previous line and the two combined represent the entire Device Marking for that device.

⁽⁶⁾ Lead/Ball Finish - Orderable Devices may have multiple material finish options. Finish options are separated by a vertical ruled line. Lead/Ball Finish values may wrap to two lines if the finish value exceeds the maximum column width.

Important Information and Disclaimer:The information provided on this page represents TI's knowledge and belief as of the date that it is provided. TI bases its knowledge and belief on information provided by third parties, and makes no representation or warranty as to the accuracy of such information. Efforts are underway to better integrate information from third parties. TI has taken and continues to take reasonable steps to provide representative and accurate information but may not have conducted destructive testing or chemical analysis on incoming materials and chemicals. TI and TI suppliers consider certain information to be proprietary, and thus CAS numbers and other limited information may not be available for release.

In no event shall TI's liability arising out of such information exceed the total purchase price of the TI part(s) at issue in this document sold by TI to Customer on an annual basis.

OTHER QUALIFIED VERSIONS OF LMV821 :

- Automotive: [LMV821-Q1](#)

NOTE: Qualified Version Definitions:

- Automotive - Q100 devices qualified for high-reliability automotive applications targeting zero defects

DGV (R-PDSO-G**)

PLASTIC SMALL-OUTLINE

24 PINS SHOWN



- NOTES: A. All linear dimensions are in millimeters.
 B. This drawing is subject to change without notice.
 C. Body dimensions do not include mold flash or protrusion, not to exceed 0,15 per side.
 D. Falls within JEDEC: 24/48 Pins – MO-153
 14/16/20/56 Pins – MO-194

D (R-PDSO-G14)

PLASTIC SMALL OUTLINE



- NOTES:
- A. All linear dimensions are in inches (millimeters).
 - B. This drawing is subject to change without notice.
 - C. Body length does not include mold flash, protrusions, or gate burrs. Mold flash, protrusions, or gate burrs shall not exceed 0.006 (0,15) each side.
 - D. Body width does not include interlead flash. Interlead flash shall not exceed 0.017 (0,43) each side.
 - E. Reference JEDEC MS-012 variation AB.

DBV (R-PDSO-G5)

PLASTIC SMALL-OUTLINE PACKAGE



4073253-4/N 12/14

- NOTES:
- All linear dimensions are in millimeters.
 - This drawing is subject to change without notice.
 - Body dimensions do not include mold flash or protrusion. Mold flash and protrusion shall not exceed 0.15 per side.
 - Falls within JEDEC MO-178 Variation AA.

DCK (R-PDSO-G5)

PLASTIC SMALL-OUTLINE PACKAGE



- NOTES:
- A. All linear dimensions are in millimeters.
 - B. This drawing is subject to change without notice.
 - C. Body dimensions do not include mold flash or protrusion. Mold flash and protrusion shall not exceed 0.15 per side.
 - D. Falls within JEDEC MO-203 variation AA.

IMPORTANT NOTICE

Texas Instruments Incorporated and its subsidiaries (TI) reserve the right to make corrections, enhancements, improvements and other changes to its semiconductor products and services per JESD46, latest issue, and to discontinue any product or service per JESD48, latest issue. Buyers should obtain the latest relevant information before placing orders and should verify that such information is current and complete. All semiconductor products (also referred to herein as "components") are sold subject to TI's terms and conditions of sale supplied at the time of order acknowledgment.

TI warrants performance of its components to the specifications applicable at the time of sale, in accordance with the warranty in TI's terms and conditions of sale of semiconductor products. Testing and other quality control techniques are used to the extent TI deems necessary to support this warranty. Except where mandated by applicable law, testing of all parameters of each component is not necessarily performed.

TI assumes no liability for applications assistance or the design of Buyers' products. Buyers are responsible for their products and applications using TI components. To minimize the risks associated with Buyers' products and applications, Buyers should provide adequate design and operating safeguards.

TI does not warrant or represent that any license, either express or implied, is granted under any patent right, copyright, mask work right, or other intellectual property right relating to any combination, machine, or process in which TI components or services are used. Information published by TI regarding third-party products or services does not constitute a license to use such products or services or a warranty or endorsement thereof. Use of such information may require a license from a third party under the patents or other intellectual property of the third party, or a license from TI under the patents or other intellectual property of TI.

Reproduction of significant portions of TI information in TI data books or data sheets is permissible only if reproduction is without alteration and is accompanied by all associated warranties, conditions, limitations, and notices. TI is not responsible or liable for such altered documentation. Information of third parties may be subject to additional restrictions.

Resale of TI components or services with statements different from or beyond the parameters stated by TI for that component or service voids all express and any implied warranties for the associated TI component or service and is an unfair and deceptive business practice. TI is not responsible or liable for any such statements.

Buyer acknowledges and agrees that it is solely responsible for compliance with all legal, regulatory and safety-related requirements concerning its products, and any use of TI components in its applications, notwithstanding any applications-related information or support that may be provided by TI. Buyer represents and agrees that it has all the necessary expertise to create and implement safeguards which anticipate dangerous consequences of failures, monitor failures and their consequences, lessen the likelihood of failures that might cause harm and take appropriate remedial actions. Buyer will fully indemnify TI and its representatives against any damages arising out of the use of any TI components in safety-critical applications.

In some cases, TI components may be promoted specifically to facilitate safety-related applications. With such components, TI's goal is to help enable customers to design and create their own end-product solutions that meet applicable functional safety standards and requirements. Nonetheless, such components are subject to these terms.

No TI components are authorized for use in FDA Class III (or similar life-critical medical equipment) unless authorized officers of the parties have executed a special agreement specifically governing such use.

Only those TI components which TI has specifically designated as military grade or "enhanced plastic" are designed and intended for use in military/aerospace applications or environments. Buyer acknowledges and agrees that any military or aerospace use of TI components which have **not** been so designated is solely at the Buyer's risk, and that Buyer is solely responsible for compliance with all legal and regulatory requirements in connection with such use.

TI has specifically designated certain components as meeting ISO/TS16949 requirements, mainly for automotive use. In any case of use of non-designated products, TI will not be responsible for any failure to meet ISO/TS16949.

Products

Audio	www.ti.com/audio
Amplifiers	amplifier.ti.com
Data Converters	dataconverter.ti.com
DLP® Products	www.dlp.com
DSP	dsp.ti.com
Clocks and Timers	www.ti.com/clocks
Interface	interface.ti.com
Logic	logic.ti.com
Power Mgmt	power.ti.com
Microcontrollers	microcontroller.ti.com
RFID	www.ti-rfid.com
OMAP Applications Processors	www.ti.com/omap
Wireless Connectivity	www.ti.com/wirelessconnectivity

Applications

Automotive and Transportation	www.ti.com/automotive
Communications and Telecom	www.ti.com/communications
Computers and Peripherals	www.ti.com/computers
Consumer Electronics	www.ti.com/consumer-apps
Energy and Lighting	www.ti.com/energy
Industrial	www.ti.com/industrial
Medical	www.ti.com/medical
Security	www.ti.com/security
Space, Avionics and Defense	www.ti.com/space-avionics-defense
Video and Imaging	www.ti.com/video

TI E2E Community

e2e.ti.com

Looking for pricing, stock, or lifecycle information?

Click below to explore more details on WIN SOURCE:

 [View LMV824IDE4](#) on WIN SOURCE

 [Texas Instruments](#) Information

Optimize Your Supply Chain with WIN SOURCE Solutions

-  Global Sourcing Solution
-  Obsolete Management
-  Cost Control Management
-  Shortage Management
-  Alternative Solution
-  Excess Inventory Management