



**THE DATASHEET OF
LMX2542LQ2121/NOPB**



LMX2542 PLLatinum™ Cellular and GPS Frequency Synthesizer System with Integrated VCO

Check for Samples: [LMX2542](#)

FEATURES

- **Small Size**
 - 5.0 mm x 5.0 mm x 0.75 mm 28-Pin WQFN
- **RF Synthesizer System**
 - Integrated RF VCO
 - Integrated Loop Filter
 - Low Spurious, Low Phase Noise Fractional-N RF PLL Based on 11-Bit $\Delta\Sigma$ Modulator
 - 5 kHz Frequency Resolution
 - Cellular-CDMA LO: 2105.28 MHz to 2155.14 MHz (Requires an External LO /2 Circuit)
 - GPS LO: 2087.73 MHz
 - (Requires an External LO /1.5 Circuit)
- **IF Synthesizer System**
 - Integer-N IF PLL
 - Programmable Charge Pump Current Levels
 - IF LO: 367.20 MHz
- **Supports Various Reference Oscillator Frequencies:**
 - 19.20 MHz/ 19.68 MHz
- **Low Current Consumption:**
 - 22 mA Typical at 2.8V
- **2.7V to 3.3V Operation**
- **RF Digital Filtered Lock Detect Output**
- **Hardware and Software Powerdown Control**

APPLICATIONS

- **Cellular-CDMA 1xRTT and IS-95 Mobile Handsets with GPS**
- **Cellular-CDMA 1xRTT and IS-95 Mobile Data Systems with GPS**

DESCRIPTION

LMX2542 is a highly integrated, high performance, low power frequency synthesizer system optimized for Cellular-CDMA 1xRTT and IS-95 mobile handsets and data systems with GPS capabilities. Using a proprietary digital phase locked loop technique, LMX2542 provides very stable, low noise local oscillator (LO) signals for up and down conversion in wireless communications devices.

LMX2542 includes a Voltage Controlled Oscillator (VCO) for both the Cellular-CDMA and GPS frequency bands, a loop filter, and a Fractional-N RF PLL based on a Delta Sigma ($\Delta\Sigma$) modulator. In concert, these blocks form a closed loop RF synthesizer system. The RF synthesizer system operates from 2087.73 MHz to 2155.14 MHz.

LMX2542 includes an Integer-N IF PLL also. For more flexible loop filter designs, the IF PLL includes a 4-level programmable charge pump. Together with an external VCO and loop filter, LMX2542 makes a complete closed loop IF synthesizer system. The default IF frequency is 367.20 MHz.

Serial data is transferred to the device via a three-wire MICROWIRE™ interface (DATA, LE, CLK).

Operating supply voltage ranges from 2.7V to 3.3V. LMX2542 features low current consumption: 22 mA at 2.8V.

LMX2542 is available in a 28-Pin Leadless Leadframe Package (WQFN).

Leadless Leadframe Package

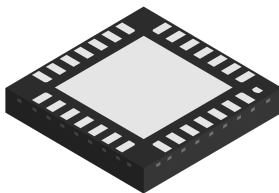

Please be aware that an important notice concerning availability, standard warranty, and use in critical applications of Texas Instruments semiconductor products and disclaimers thereto appears at the end of this data sheet.

All trademarks are the property of their respective owners.

Connection Diagram

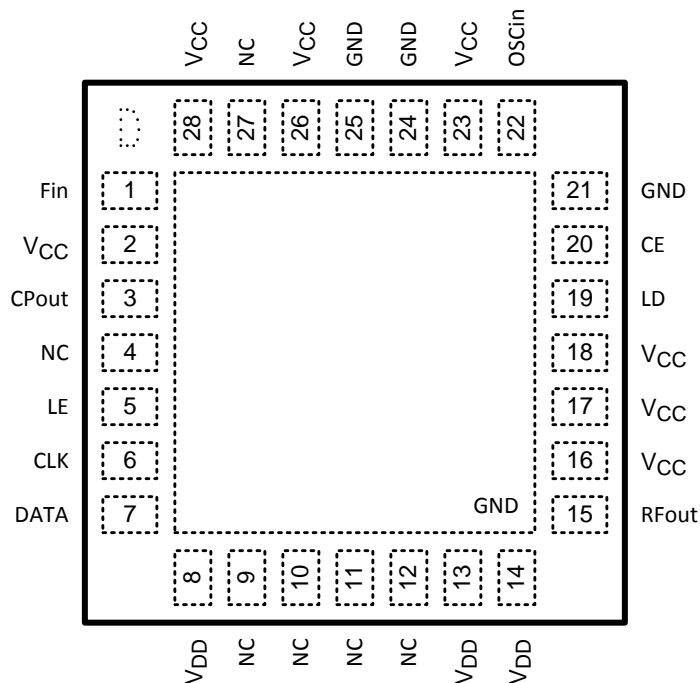

Note: Analog GND connected through exposed die attached pad.

**Leadless Leadframe Package (WQFN)
(Top View)
See Package Number NJB**

PIN DESCRIPTION

Pin No.	Pin Name	I/O	Description
1	Fin	I	IF PLL buffer/prescaler input. Small signal input from the VCO.
2	V _{CC}	—	Power supply bias for the IF PLL analog circuits. V _{CC} may range from 2.7V to 3.3V. Bypass capacitors should be placed as close as possible to this pin and be connected directly to the ground plane on the printed circuit board.
3	CPout	O	IF PLL charge pump output. The output is connected to the external loop filter, which drives the input of the IF VCO.
4	NC	—	No Connect. Do not connect to any node on the printed circuit board.
5	LE	I	MICROWIRE Latch Enable Input. High impedance CMOS input. When LE transitions from LOW to HIGH, DATA stored in the shift register is loaded into one of 6 internal control registers.
6	CLK	I	MICROWIRE Clock Input. High impedance CMOS input. DATA is clocked into the 24-bit shift register on the rising edge of CLK.
7	DATA	I	MICROWIRE Data Input. High impedance CMOS input. Binary serial data. The MSB of DATA is shifted in first.
8	V _{DD}	—	Power supply bias for the RF VCO. V _{DD} may range from 2.7V to 3.3V. Bypass capacitors should be placed as close as possible to this pin and be connected directly to the ground plane on the printed circuit board.
9	NC	—	No Connect. Do not connect to any node on the printed circuit board.
10	NC	—	No Connect. Do not connect to any node on the printed circuit board.
11	NC	—	No Connect. Do not connect to any node on the printed circuit board.
12	NC	—	No Connect. Do not connect to any node on the printed circuit board.

PIN DESCRIPTION (continued)

Pin No.	Pin Name	I/O	Description
13	V _{DD}	—	Power supply bias for the RF VCO. V _{DD} may range from 2.7V to 3.3V. Bypass capacitors should be placed as close as possible to this pin and be connected directly to the ground plane on the printed circuit board.
14	V _{DD}	—	Power supply bias for the RF VCO output buffer. V _{DD} may range from 2.7V to 3.3V. Bypass capacitors should be placed as close as possible to this pin and be connected directly to the ground plane on the printed circuit board.
15	RFout	O	Buffered RF VCO output.
16	V _{CC}	—	Power supply bias for the RF PLL prescaler. V _{CC} may range from 2.7V to 3.3V. Bypass capacitors should be placed as close as possible to this pin and be connected directly to the ground plane on the printed circuit board.
17	V _{CC}	—	Power supply bias for the RF PLL charge pump. V _{CC} may range from 2.7V to 3.3V. Bypass capacitors should be placed as close as possible to this pin and be connected directly to the ground plane on the printed circuit board.
18	V _{CC}	—	Power supply bias for the RF PLL digital circuits. V _{CC} may range from 2.7V to 3.3V. Bypass capacitors should be placed as close as possible to this pin and be connected directly to the ground plane on the printed circuit board.
19	LD	O	Digital filtered lock detect output.
20	CE	I	Chip Enable input. High Impedance CMOS input. When this pin is set HIGH, the RF and IF synthesizer systems are powered up. Powerdown is then controlled through the MICROWIRE. When this pin is set LOW, the device is asynchronously powered down and the IF PLL charge pump output is forced to a high impedance state (Tri-State).
21	GND	—	Ground for the RF PLL digital circuits.
22	OSCin	I	Reference oscillator input. The input is driven by an external AC coupled source. When the OSC_FREQ bit is set LOW, a 19.20 MHz reference frequency should be used. When the OSC_FREQ bit is set HIGH, a 19.68 MHz reference frequency should be used.
23	V _{CC}	—	Power supply bias for the reference oscillator buffer. V _{CC} may range from 2.7V to 3.3V. Bypass capacitors should be placed as close as possible to this pin and be connected directly to the ground plane on the printed circuit board.
24	GND	—	Ground for the reference oscillator buffer.
25	GND	—	Ground for the IF PLL digital circuits.
26	V _{CC}	—	Power supply bias for the IF PLL digital circuits. V _{CC} may range from 2.7V to 3.3V. Bypass capacitors should be placed as close as possible to this pin and be connected directly to the ground plane on the printed circuit board.
27	NC	—	No Connect. Do not connect to any node on the printed circuit board.
28	V _{CC}	—	Power supply bias for the IF PLL buffer/ prescaler. V _{CC} may range from 2.7V to 3.3V. Bypass capacitors should be placed as close as possible to this pin and be connected directly to the ground plane on the printed circuit board.

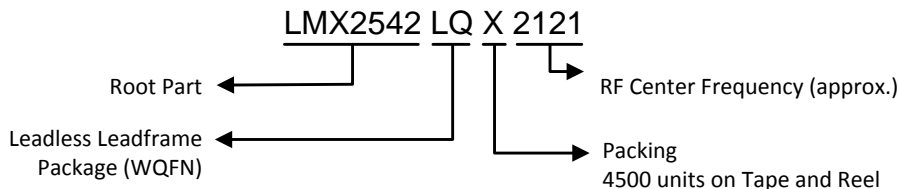
Part Number Description



These devices have limited built-in ESD protection. The leads should be shorted together or the device placed in conductive foam during storage or handling to prevent electrostatic damage to the MOS gates.

Absolute Maximum Ratings⁽¹⁾⁽²⁾⁽³⁾⁽⁴⁾

Power Supply Voltage	V_{CC} to GND	-0.3V to +3.6V
	V_{DD} to GND	-0.3V to +3.6V
Voltage on any pin to GND (V_{IN})	V_{IN} must be < +3.6V	-0.3V to $V_{CC}+0.3V$
		-0.3V to $V_{DD}+0.3V$
Storage Temperature Range (T_S)		-65°C to +150°C
Lead Temperature (solder 4 s) (T_L)		+260°C

- (1) Absolute Maximum Ratings indicate limits beyond which damage to the device may occur. Recommended Operating Conditions indicate conditions for which the device is intended to be functional, but do not ensure specific performance limits. For ensured specifications and test conditions, refer to the [Electrical Characteristics](#) section. The ensured specifications apply only for the conditions listed.
- (2) This device is a high performance RF integrated circuit with an ESD rating < 2kV and is ESD sensitive. Handling and assembly of this device should be done at ESD protected work stations.
- (3) GND = 0V.
- (4) If Military/Aerospace specified devices are required, please contact the TI Sales Office/ Distributors for availability and specifications.

Recommended Operating Conditions

Power Supply Voltage	V_{CC} to GND	+2.7V to +3.3V
	V_{DD} to GND	+2.7V to +3.3V
Operating Temperature (T_A)		-30°C to +85°C

Electrical Characteristics

$V_{CC} = V_{DD} = CE = 2.8V$, $T_A = +25^{\circ}C$, unless otherwise specified

Symbol	Parameter	Conditions	Value			Units
			Min	Typ	Max	
ICC PARAMETERS						
$I_{CC} + I_{DD}$	Power Supply Current (RF and IF Synthesizer Systems)	RF_EN Bit = 1 IF_EN Bit = 1 OB_CRL[1:0] Word = 00 VCO_CUR[1:0] Word = 11 IF_CUR[1:0] Word = 00		22.0	24.0	mA
$(I_{CC} + I_{DD})_{RF}$	Power Supply Current (RF Synthesizer System)	RF_EN Bit = 1 IF_EN Bit = 0 OB_CRL[1:0] Word = 00 VCO_CUR[1:0] Word = 11		20.0	22.0	mA
I_{PD}	Powerdown Current	CE, CLK, DATA and LE = 0V OSCin = 0V (RF_EN Bit = 0 and IF_EN Bit = 0)			20.0	μ A
RF SYNTHESIZER SYSTEM PARAMETERS						
RF VCO						
f_{RFout}	RF VCO Operating Frequency ⁽¹⁾⁽²⁾		2087.73		2155.14	MHz
P_{RFout}	RF VCO Output Power	OB_CRL[1:0] Word = 00	-7.5	-4.5	-1.5	dBm
		OB_CRL[1:0] Word = 01	-5.0	-2.0	1.0	dBm
		OB_CRL[1:0] Word = 10	-2.5	0.5	3.5	dBm
		OB_CRL[1:0] Word = 11	0.0	3.0	6.0	dBm
Φ_{eRF}	RF VCO RMS Phase Error			1.3		Deg.
$L_{RF}(f)$	RF VCO Single Side Band Phase Noise	f = 100 kHz Offset TCXO Reference Source OSC_FREQ Bit = 0 or 1 OB_CRL[1:0] Word = 11 IF_EN Bit = 0		-109	-107	dBc/ Hz
		f = 900 kHz Offset TCXO Reference Source OSC_FREQ Bit = 0 or 1 OB_CRL[1:0] Word = 11 IF_EN Bit = 0		-134	-133	dBc/ Hz
$SPURS_{RF}$	RF Synthesizer Reference Spurs	OSC_FREQ Bit = 0 or 1 IF_EN Bit = 0			-75	dBc
HS_{RF}	RF VCO Harmonic Suppression	2 ND Harmonic OB_CRL[1:0] Word = 11			-25	dBc
		3 RD Harmonic OB_CRL[1:0] Word = 11			-25	dBc
t_{RFLOCK}	Channel Switch Lock Time ⁽³⁾	$f_{INITIAL} = 2087.73$ MHz $f_{FINAL} = 2155.14$ MHz		1.0	1.3	ms

(1) For other RF frequency ranges, please contact Texas Instruments.

(2) When the Cellular-CDMA mode is used, an external /2 circuit is required before the Cellular mixer LO port. Furthermore, if an external /1.5 circuit is available before the GPS mixer LO port, the GPS frequency of 1391.82 MHz can be achieved by using a fixed RF frequency of 2087.73 MHz.

(3) Lock time is defined as the time difference between the beginning of the frequency transition and the point at which the frequency remains within +/- 1 kHz of the final frequency. $t_{LOCK} = t_{FINAL} - t_{INITIAL}$.

Electrical Characteristics (continued)
 $V_{CC} = V_{DD} = CE = 2.8V$, $T_A = +25^{\circ}C$, unless otherwise specified

Symbol	Parameter	Conditions	Value			Units
			Min	Typ	Max	
IF SYNTHESIZER SYSTEM PARAMETERS						
f_{Fin}	IF Synthesizer Operating Frequency ⁽⁴⁾	SPI_DEF Bit = 1 IF_FREQ[1:0] Word = 00		170.76		MHz
		SPI_DEF Bit = 1 IF_FREQ[1:0] Word = 01 (Default)		367.20		MHz
		SPI_DEF Bit = 1 IF_FREQ[1:0] Word = 10		440.76		MHz
$f_{\phi F}$	IF Synthesizer Phase Detector Frequency			120		kHz
p_{Fin}	IF Synthesizer Input Sensitivity		-12		0	dBm
$I_{CPoutIF}$	IF Synthesizer Charge Pump Output Current	IF_CUR[1:0] Word = 00		100		μA
		IF_CUR[1:0] Word = 01		200		μA
		IF_CUR[1:0] Word = 10		300		μA
		IF_CUR[1:0] Word = 11		800		μA
REFERENCE OSCILLATOR PARAMETERS						
f_{OSCin}	Reference Oscillator Input Operating Frequency ⁽⁵⁾	OSC_FREQ Bit = 0	19.20			MHz
		OSC_FREQ Bit = 1			19.68	MHz
V_{OSCin}	Reference Oscillator Input Sensitivity			0.2	V_{CC}	V_{PP}
DIGITAL INTERFACE (CE, DATA, CLK, LE, LD)						
V_{IH}	High-Level Input Voltage		$0.8 V_{DD}$		V_{DD}	V
			$0.8 V_{CC}$		V_{CC}	V
V_{IL}	Low-Level Input Voltage		0		$0.2 V_{DD}$	V
			0		$0.2 V_{CC}$	V
I_{IH}	High-Level Input Current	$V_{IH} = V_{DD} = V_{CC}$			10	μA
I_{IL}	Low-Level Input Current	$V_{IL} = 0V$	-10			μA
C_I	Input Capacitance			3.0		pF
V_{OH}	High-Level Output Voltage		$0.9 V_{DD}$			V
			$0.9 V_{CC}$			V
V_{OL}	Low-Level Output Voltage				$0.1 V_{DD}$	V
					$0.1 V_{CC}$	V
C_O	Output Capacitance				5.0	pF

- (4) For frequencies other than the default values, the SPI_DEF bit should be set to 0 and registers R4 and R5 programmed appropriately. Refer to [Serial Port Interface Default Register Selection](#) for further details on how to program the SPI_DEF bit.
- (5) For other reference oscillator frequencies, please contact Texas Instruments.

Electrical Characteristics (continued)

$V_{CC} = V_{DD} = CE = 2.8V$, $T_A = +25^{\circ}C$, unless otherwise specified

Symbol	Parameter	Conditions	Value			Units
			Min	Typ	Max	
MICROWIRE INTERFACE						
t_{CS}	DATA to CLK Set Up Time		50.0			ns
t_{CH}	DATA to CLK Hold Time		10.0			ns
t_{CWH}	CLK Pulse Width HIGH		50.0			ns
t_{CWL}	CLK Pulse Width LOW		50.0			ns
t_{ES}	CLK to LE Set Up Time		50.0			ns
t_{EW}	LE Pulse Width		50.0			ns

Typical Performance Characteristics

RF VCO Output Impedance
 $V_{DD} = V_{CC} = 2.8V, T_A = 25^\circ C$

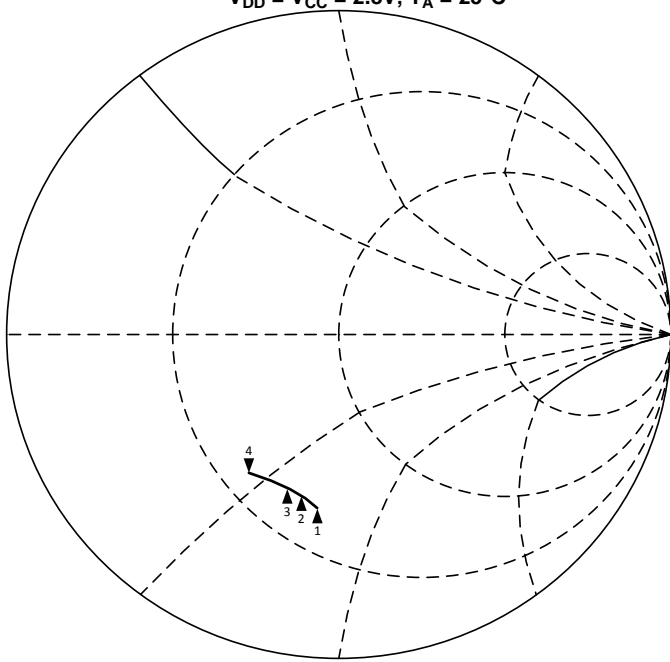

IF PLL Input Impedance
 $V_{DD} = V_{CC} = 2.8V, T_A = 25^\circ C$

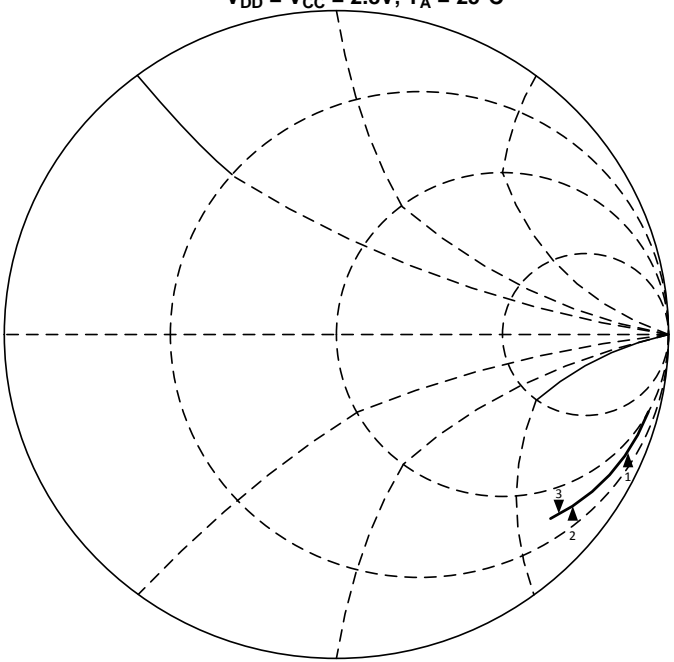

RFout (MHz)	R Ω	jX Ω	R + jX Ω
2087.73	26.406	-34.650	46.564
2105.28	25.385	-30.800	39.913
2121.00	23.898	-28.122	36.905
2155.14	19.979	-23.102	30.543

Fin (MHz)	R Ω	jX Ω	R + jX Ω
170.76	33.789	-239.220	241.595
367.20	26.992	-137.620	140.242
440.76	27.844	-126.470	129.499

Serial Data Input Timing

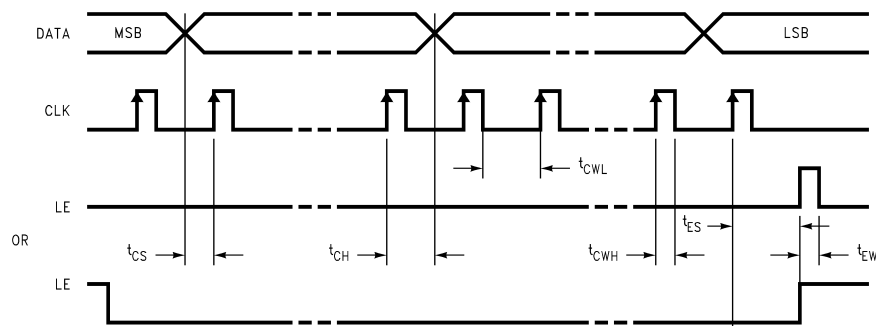

Figure 1. Serial Data Input Timing

NOTE

1. DATA is clocked into the 24-bit shift register on the rising edge of CLK.
2. The MSB of DATA is shifted in first.

FUNCTIONAL DESCRIPTION

LMX2542 is a highly integrated, high performance, low power, frequency synthesizer system optimized for Cellular-CDMA 1xRTT and IS-95 mobile handsets and data systems with GPS capabilities. Using a proprietary digital phase locked loop technique, LMX2542 generates very stable, low noise local oscillator (LO) signals for up and down conversion in wireless communications devices.

LMX2542 includes a Voltage Controlled Oscillator (VCO) for the Cellular-CDMA and GPS frequency bands, a loop filter, and a Fractional-N RF PLL based on a $\Delta\Sigma$ modulator which supports frequency resolutions as low as 5 kHz. In concert, these blocks form a closed loop RF synthesizer system. The RF synthesizer system operates from 2087.73 MHz to 2155.14 MHz. The need for external components is limited to a few passive elements for matching the RF output impedance, and bypass elements for power line stabilization.

The Fractional-N RF PLL ($\Delta\Sigma$ modulator architecture) delivers low spurious thus providing a significant improvement over other PLL solutions. In addition, the Fractional-N RF PLL facilitates faster lock times, which reduces power consumption and system set-up time. Furthermore, the RF loop filter occupies a much smaller area as opposed to the Integer-N architecture. This allows the RF loop filter to be embedded into the circuit, thus minimizing the external noise coupling.

LMX2542 includes an Integer-N IF PLL also. For more flexible loop filter designs, the IF PLL includes a 4-level programmable charge pump. Together with an external VCO and loop filter, LMX2542 makes a complete closed loop IF synthesizer system. The default IF frequency is 367.20 MHz.

The circuit also supports commonly used reference oscillator frequencies of 19.20 MHz and 19.68 MHz.

FREQUENCY GENERATION

RF Frequency Selection

The RF synthesizer (Cellular-CDMA) divide ratio can be calculated using the following equation:

$$f_{\text{RFout}} = \left(8 \cdot \text{RF_B} + \text{RF_A} + \frac{10^4 \cdot \text{RF_FN}}{f_{\text{OSCin}}} \right) \cdot f_{\text{OSCin}}$$

where

- RF_A < RF_B
- f_{RFout} : RF VCO output frequency
- f_{OSCin} : Reference oscillator frequency
- RF_A : Preset divide ratio of the RF PLL binary 3-bit swallow counter ($0 \leq \text{RF_A} \leq 7$)
- RF_B : Preset divide ratio of the RF PLL binary 4-bit programmable counter ($2 \leq \text{RF_B} \leq 15$)
- RF_FN : Preset numerator of the RF PLL binary 11-bit modulus counter ($0 \leq \text{RF_FN} < 1920$ for $f_{\text{OSCin}} = 19.20$ MHz)
($0 \leq \text{RF_FN} < 1968$ for $f_{\text{OSCin}} = 19.68$ MHz) (1)

NOTE

When the `FREQ_OFF` bit is set to 1, frequencies with 5 kHz resolution can be generated. In the same way outlined above, the divide ratio for the desired frequency less 5 kHz should be programmed. When the `FREQ_OFF` bit (`R1[2]`) is set to 1, the programmed frequency will be shifted by +5 kHz in order to achieve the desired frequency. Refer to [RF Synthesizer System Frequency Offset](#) for details on how to program the `FREQ_OFF` bit.

IF Frequency Selection

The IF synthesizer divide ratio can be calculated using the following equation:

$$f_{\text{Fin}} = (16 \cdot \text{IF_B} + \text{IF_A}) \cdot \frac{f_{\text{OSCin}}}{\text{IF_R}}$$

where

- IF_A < IF_B
- f_{Fin} : IF VCO output frequency
- f_{OSCin} : Reference oscillator frequency
- IF_A : Preset divide ratio of the IF PLL binary 4-bit swallow counter ($0 \leq \text{IF_A} \leq 15$)
- IF_B : Preset divide ratio of the IF PLL binary 9-bit programmable counter ($1 \leq \text{IF_B} \leq 511$)
- IF_R : Preset divide ratio of the IF PLL binary 9-bit programmable reference counter ($2 \leq \text{IF_R} \leq 511$)

From the above equation and with the SPI_DEF bit set to 1, LMX2542 generates a fixed IF frequency of 367.20 MHz as follows:

f_{Fin} (MHz)	IF_B	IF_A	$f_{\text{OSCin}} / \text{IF_R}$ (kHz)
367.20	191	4	120

VCO FREQUENCY TUNING

The center frequency of the RF VCO is determined mainly by the resonant frequency of the tank circuit. This tank circuit is implemented on-chip and requires no external inductor. LMX2542 actively tunes the tank circuit to the required frequency with the built-in tracking algorithm.

POWER CONTROL

LMX2542 includes a powerdown mode to reduce the power consumption. LMX2542 can be powered down when the CE pin is set LOW, independent of the state of the powerdown bits. When CE is set HIGH, powerdown is controlled through the MICROWIRE. The RF and IF circuitries are individually powered down by setting the RF_EN (R1[3]) and IF_EN (R2[2]) bits LOW respectively. Refer to [RF Synthesizer System Enable](#) and [IF Synthesizer Enable](#) for details on how to program the RF_EN and IF_EN bits.

CE Pin	RF_EN	IF_EN	RF Circuitry	IF Circuitry
0	X	X	OFF	OFF
1	0	0	OFF	OFF
1	0	1	OFF	ON
1	1	0	ON	OFF
1	1	1	ON	ON

NOTE

1. X refers to a don't care condition.
2. The RF circuitry includes the whole RF synthesizer system (synthesizer and VCO).
3. The IF circuitry includes the IF synthesizer block only.

RF DIGITAL FILTERED LOCK DETECT

A digital filtered lock detect status generated from the RF phase frequency detector (PFD) is available on the LD pin (Pin 19) when the RF_LD bit (R0[21]) is set to 1. The LD output is therefore used to indicate the lock status of the RF synthesizer system. Furthermore, the LD output can be forced to GND at all times when the RF_LD bit is set to 0.

When used as a lock detect output, the two inputs to the PFD, f_N and f_R , are first divided by 64. The lock detect digital filter then compares the difference between the phases of the inputs to the PFD to an RC generated delay of approximately 10 ns. This delay is represented by t_W in [Figure 2](#) and [Figure 3](#) below. If the phase error is less than 10 ns ($\Delta t < t_W$) for 4 consecutive PFD comparison cycles, the RF PLL enters a locked state and the LD output is then forced HIGH. Once the phase error becomes greater than 10 ns ($\Delta t > t_W$) the RF PLL falls out of lock and the LD is forced LOW (~GND). The phase error in [Figure 3](#) is measured on the leading edge. If the phase difference between the two inputs to the PFD is equal to 10 ns ($\Delta t = t_W$), then the LD output becomes unpredictable. Refer to [RF Synthesizer Lock Defect](#) for further details on how to program the digital filtered lock detect.

NOTE

f_R is the PFD input from the reference oscillator and f_N is the PFD input from the programmable feedback divider (N counter).

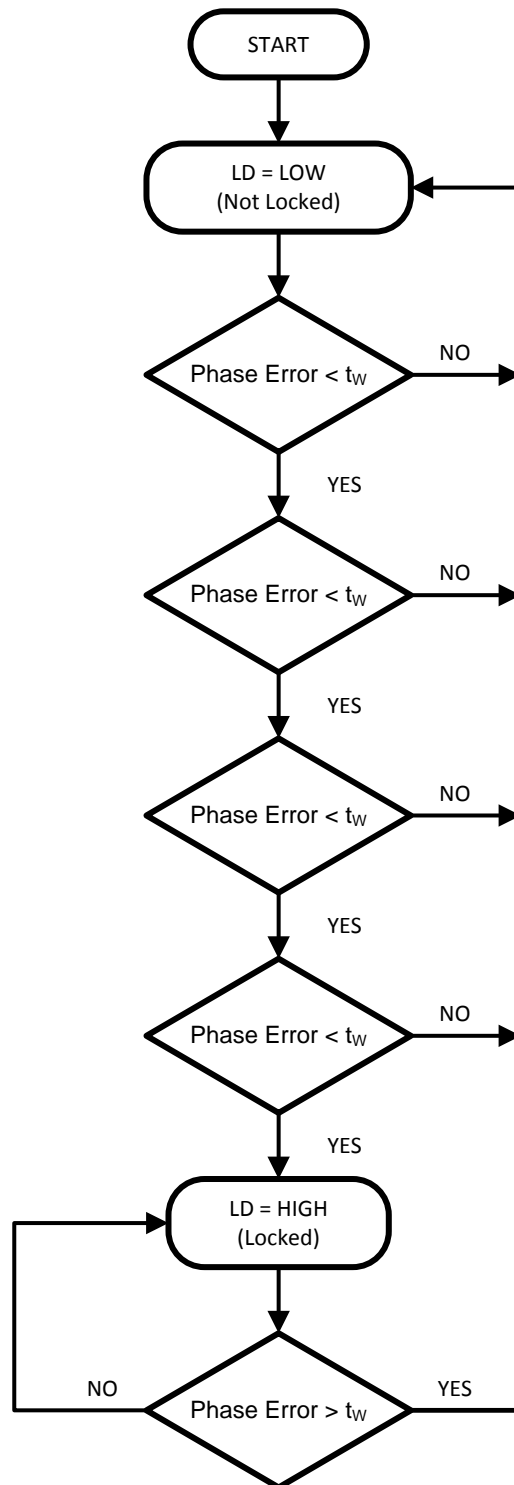

Figure 2. Lock Detect Flow Diagram

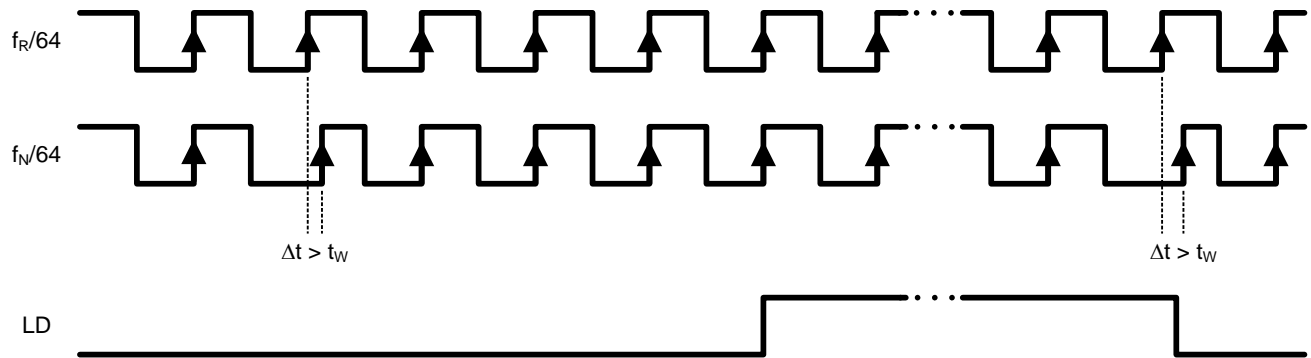

Figure 3. Lock Detect Timing Diagram Waveform

MICROWIRE SERIAL INTERFACE

The programmable register set is accessed via the MICROWIRE serial interface. The interface comprises three signal pins: CLK, DATA, and LE. Serial data is clocked into the 24-bit shift register on the rising edge of CLK. The least significant bits decode the internal control register address. When LE transitions from LOW to HIGH, DATA stored in the shift registers is loaded into one of six control registers. The MSB of DATA is loaded in first. The synthesizers can be programmed even in power down mode. A complete programming description is provided in [Programming Description](#).

Programming Description

MICROWIRE INTERFACE

The MICROWIRE Serial Port Interface (SPI) has a 24-bit shift register to store the incoming DATA bits temporarily. The incoming DATA is loaded into the shift register from MSB to LSB. The data is shifted at the rising edge of the CLK signal. When the LE signal transitions from LOW to HIGH, the DATA stored in the shift register is transferred to the proper register depending on the state of the ADDRESS bits. The selection of the particular register is determined by the address bits equal to the binary representation of the number of the control register.

At start-up, the 24-bit shift register is loaded via the MICROWIRE interface. The loading requires 3 default words, with register R2 loaded first, and R0 loaded last. Once loaded, the RF VCO frequency can then be changed by only programming register R0 appropriately. If an IF frequency other than the default value is desired, the SPI_DEF bit should be set to 0, and registers R4 and R5 programmed appropriately.

Control Register Content Map

The control register content map describes how the bits within each control register are allocated to specific control functions. The bits that are marked 0 should be programmed as such to ensure proper device operation.

Table 1. Control Register Content Map

R eg	23	22	21	20	19	18	17	16	15	14	13	12	11	10	9	8	7	6	5	4	3	2	1	0	
	SHIFT REGISTER BIT LOCATION																							LSB	
R 0	SPI_DEF	1	RF_LD	0	RF_B [3:0]			RF_A [2:0]			RF_FN [10:0]										0	0			
R 1	0	1	1	0	1	0	0	0	1	0	1	0	1	0	0	0	1	OB_CRL [1:0]	RF_EN	FREQ_OFF	0	1			
R 2	1	1	0	0	1	0	0	1	0	0	0	0	0	0	VCO_CUR [1:0]	OSC_FREQ	IF_FREQ [1:0]	IF_CUR [1:0]	IF_EN	1	0				
R 3	0	0	0	0	0	0	0	0	0	0	0	1	0	1	0	0	1	0	0	1	0	0	1	1	
R 4	0	0	0	0	0	0	0	IF_A [3:0]			IF_B [8:0]								0	1	1	1	1		
R 5	0	0	0	0	0	0	0	0	0	IF_R [8:0]										0	1	1	1	1	1
R 6	0	0	0	0	0	0	0	1	1	1	1	1	1	1	1	1	1	1	0	1	1	1	1	1	1

NOTE

Numbers in **Bold** represent the ADDRESS bits.

R0 REGISTER

The R0 register contains the RF_FN, RF_A, RF_B, RF_LD, and SPI_DEF control words. The register address bits are R0[1:0] = 00. The detailed descriptions and programming information for each control word is discussed in the following sections.

Reg	23	22	21	20	19	18	17	16	15	14	13	12	11	10	9	8	7	6	5	4	3	2	1	0
	MSB		SHIFT REGISTER BIT LOCATION																				LSB	
	DATA[21:0] FIELD																						ADDRESS [1:0] FIELD	
R0	SPI_DEF	1	RF_LD	0	RF_B [3:0]			RF_A [2:0]			RF_FN [10:0]							0	0					

RF_FN[10:0] - RF Synthesizer Fractional Numerator Counter (R0[2:12])

The RF_FN control word is used to setup the 11-bit $\Delta\Sigma$ modulator. This corresponds to programming the fractional numerator counter portion of the RF feedback divider. The value programmed is dependent on the reference oscillator used.

Programming RF_FN[10:0] Using 19.20 MHz Reference Oscillator

When a 19.20 MHz reference oscillator is used (OSC_FREQ bit = 0), the RF_FN can be programmed to values ranging from 0 to 1919.

Numerator	RF_FN[10:0] $f_{\text{OSCin}} = 19.20 \text{ MHz}$										
	10	9	8	7	6	5	4	3	2	1	0
0	0	0	0	0	0	0	0	0	0	0	0
1	0	0	0	0	0	0	0	0	0	0	1
•	•	•	•	•	•	•	•	•	•	•	•
1919	1	1	1	0	1	1	1	1	1	1	1

Programming RF_FN[10:0] Using 19.68 MHz Reference Oscillator

Similarly, when a 19.68 MHz reference oscillator is used (OSC_FREQ bit = 1), the RF_FN can be programmed to values ranging from 0 to 1967.

Numerator	RF_FN[10:0] $f_{\text{OSCin}} = 19.68 \text{ MHz}$										
	10	9	8	7	6	5	4	3	2	1	0
0	0	0	0	0	0	0	0	0	0	0	0
1	0	0	0	0	0	0	0	0	0	0	1
•	•	•	•	•	•	•	•	•	•	•	•
1967	1	1	1	1	0	1	0	1	1	1	1

RF_A[2:0] - RF Synthesizer Swallow Counter (A Counter) (R0[13:15])

The RF_A control word is used to setup the RF synthesizer's A counter. The A counter is a 3-bit swallow counter used in the programmable feedback divider. The RF_A control word can be programmed to values ranging from 0 to 7.

Divide Ratio	RF_A[2:0] RF Mode		
	2	1	0
0	0	0	0
1	0	0	1
•	•	•	•
7	1	1	1

RF_B[3:0] - RF Synthesizer Programmable Binary Counter (B Counter) (R0[16:19])

The RF_B control word is used to setup the RF synthesizer's B counter. The B counter is a 4-bit programmable binary counter used in the programmable feedback divider. The RF_B control word can be programmed to values ranging from 2 to 15. Divide ratios less than 2 are prohibited.

Divide Ratio	RF_B[3:0]			
	3	2	1	0
2	0	0	1	0
3	0	0	1	1
•	•	•	•	•
15	1	1	1	1

RF_LD - RF Synthesizer System Lock Detect (R0[21])

The RF_LD bit is used to indicate the lock status of the RF synthesizer system.

Control Bit	Register Location	Description	Function	
			0	1
RF_LD	R0[21]	RF Synthesizer System Lock Detect	Hard Zero (GND)	Lock Detect

SPI_DEF - Serial Port Interface Default Register Selection (R0[23])

The SPI_DEF bit selects between using the default IF counter values and user programmable values.

Control Bit	Register Location	Description	Function	
			0	1
SPI_DEF	R0[23]	Serial Port Interface Default Register Selection	Default Counter Values OFF. Program Registers R0 through R6	Default Counter Values ON. Program Registers R0 through R2

R1 REGISTER

The R1 register contains the **FREQ_OFF**, **RF_EN** and **OB_CRL** control words. The register address bits are **R1[1:0] = 01**. The detailed descriptions and programming information for each control word is discussed in the following sections.

Reg	23	22	21	20	19	18	17	16	15	14	13	12	11	10	9	8	7	6	5	4	3	2	1	0
	MSB	SHIFT REGISTER BIT LOCATION																						LSB
	DATA[21:0]																						ADDRESS [1:0] FIELD	
R1	0	1	1	0	1	0	0	0	1	0	1	0	1	0	1	0	0	1	OB_CRL [1:0]	RF _EN	FRE Q_ OFF	0	1	

FREQ_OFF - RF Synthesizer System Frequency Offset (R1[2])

The **FREQ_OFF** bit is used to offset the RF frequency by +5 kHz.

Control Bit	Register Location	Description	Function	
			0	1
FREQ_OFF	R1[2]	RF Synthesizer System Frequency Offset	RF Synthesizer System Frequency Offset Disabled	RF Synthesizer System Frequency Offset Enabled

RF_EN - RF Synthesizer System Enable (R1[3])

The **RF_EN** bit is used to switch the RF synthesizer system (PLL and VCO) between a powered up and powered down mode.

Control Bit	Register Location	Description	Function	
			0	1
RF_EN	R1[3]	RF Synthesizer System Enable	RF Synthesizer System Powered Down	RF Synthesizer System Active

OB_CRL[1:0] - RF VCO Output Buffer Power Control (R1[5:4])

The **OB_CRL** word is used to set the RF VCO output buffer power level. The power level can be set according to the system requirements.

OB_CRL[1:0]		RF VCO Output Buffer Power Level (dBm)
0	0	-4.5
0	1	-2.0
1	0	0.5
1	1	3.0

R2 REGISTER

The R2 register contains the **IF_EN**, **IF_CUR**, **IF_FREQ**, **OSC_FREQ**, and **VCO_CUR** control words. The register address bits are **R2[1:0] = 10**. The detailed descriptions and programming information for each control word is discussed in the following sections.

Reg	23	22	21	20	19	18	17	16	15	14	13	12	11	10	9	8	7	6	5	4	3	2	1	0
	MSB	SHIFT REGISTER BIT LOCATION																						LSB
	DATA[21:0] FIELD																						ADDRESS [1:0] FIELD	

R2	1	1	0	0	1	0	0	1	0	0	0	0	0	0	VCO_CUR UR [1:0]	OSC - FRE Q	IF_FRE Q [1:0]	IF_CUR [1:0]	IF_EN	1	0
----	---	---	---	---	---	---	---	---	---	---	---	---	---	---	------------------------	----------------------	----------------------	-----------------	-------	---	---

IF_EN - IF Synthesizer Enable (R2[2])

The IF_EN bit is used to switch the IF synthesizer between a powered up and powered down mode.

Control Bit	Register Location	Description	Function	
			0	1
IF_EN	R2[2]	IF Synthesizer Enable	IF Synthesizer Powered Down	IF Synthesizer Active

IF_CUR[1:0] - IF Synthesizer Charge Pump Current Gain (R2[4:3])

The IF_CUR control word is used to set the IF synthesizer's charge pump current gain. Four gain levels are available.

IF_CUR[1:0]		IF Synthesizer Charge Pump Current Gain (μA)
0	0	100
0	1	200
1	0	300
1	1	800

IF_FREQ[1:0] - IF Synthesizer Fixed Frequency Selection (R2[6:5])

The IF_FREQ control word is used to set the default fixed IF frequency applicable to the specific CDMA system. For LMX2542, the default fixed IF frequency is 367.20 MHz.

IF_FREQ[1:0]		Fixed IF Frequency (MHz)
0	0	170.76
0	1	367.20
1	0	440.76

OSC_FREQ - Reference Oscillator Frequency Select (R2[7])

The OSC_FREQ bit is used to select the appropriate reference oscillator frequency.

Control Bit	Register Location	Description	Function	
			0	1
OSC_FREQ	R2[7]	Reference Oscillator Select	19.20 MHz Reference Oscillator Selected	19.68 MHz Reference Oscillator Selected

VCO_CUR[1:0] - RF VCO Dynamic Current (R2[9:8])

The VCO_CUR control word is used to set the dynamic current for the RF VCO. A maximum dynamic current is recommended, and is achieved when VCO_CUR[1:0] word = 11.

VCO_CUR[1:0]		RF VCO Current Magnitude
0	0	Minimum
•	•	•
•	•	•
1	1	Maximum

R3 REGISTER

The R3 register is used for internal testing of the device and is not intended for customer use. The register address bits are R3[2:0] = 011. Register R3 is active only when the SPI_DEF bit in Register R0 is set to 0.

Reg	23	22	21	20	19	18	17	16	15	14	13	12	11	10	9	8	7	6	5	4	3	2	1	0
	SHIFT REGISTER BIT LOCATION																							
	DATA[20:0] FIELD																				ADDRESS [2:0] FIELD			
R3	0	0	0	0	0	0	0	0	0	0	0	1	0	1	0	0	1	0	0	1	0	0	1	1

R4 REGISTER

The R4 register contains the IF_B and IF_A control words. The register address bits are R4[3:0] = 0111. Register R4 is active only when the SPI_DEF bit in Register R0 is set to 0. Register R4 should only be used to set the IF N counter if the default value is not desired. The detailed descriptions and programming information for each control word is discussed in the following sections.

Reg	23	22	21	20	19	18	17	16	15	14	13	12	11	10	9	8	7	6	5	4	3	2	1	0
	SHIFT REGISTER BIT LOCATION																							
	DATA[19:0]																			ADDRESS [3:0] FIELD				
R4	0	0	0	0	0	0	0	IF_A [3:0]				IF_B [8:0]				0	1	1	1					

IF_B[8:0] - IF Synthesizer Programmable Binary Counter (B Counter) (R4[12:4])

The IF_B control word is used to setup the IF synthesizer's B counter. The B counter is a 9-bit programmable binary counter used in the programmable feedback divider. The IF_B control word can be programmed to values ranging from 1 to 511. Divide ratios less than 1 are prohibited.

Divide Ratio	IF_B[8:0]								
	8	7	6	5	4	3	2	1	0
1	0	0	0	0	0	0	0	0	1
2	0	0	0	0	0	0	0	1	0
•	•	•	•	•	•	•	•	•	•
511	1	1	1	1	1	1	1	1	1

IF_A[3:0] - IF Synthesizer Swallow Counter (A Counter) (R4[16:13])

The IF_A control word is used to setup the IF synthesizer's A counter. The A counter is a 4-bit swallow counter used in the programmable feedback divider. The IF_A control word can be programmed to values ranging from 0 to 15.

Divide Ratio	IF_A[3:0]			
	3	2	1	0
0	0	0	0	0
1	0	0	0	1
•	•	•	•	•
15	1	1	1	1

R5 REGISTER

The R5 register contains the IF_R control word. The register address bits are R5[4:0] = 01111. Register R5 is active only when the SPI_DEF bit in Register R0 is set to 0. Register R5 should only be used to set the IF R counter if the default value is not desired. The detailed description and programming information for this control word is discussed in the following section.

Reg	23	22	21	20	19	18	17	16	15	14	13	12	11	10	9	8	7	6	5	4	3	2	1	0
	MSB	SHIFT REGISTER BIT LOCATION																					LSB	
	DATA[18:0] FIELD																	ADDRESS [4:0] FIELD						
R5	0	0	0	0	0	0	0	0	0	0	IF_R [8:0]					0	1	1	1	1				

IF_R[8:0] - IF Synthesizer Programmable Reference Divider (R5[13:5])

The IF_R control word is used to setup the IF synthesizer's reference divider. The IF_R control word can be programmed to values ranging from 2 to 511. Divide ratios less than 2 are prohibited.

Divide Ratio	IF_R[8:0]								
	8	7	6	5	4	3	2	1	0
2	0	0	0	0	0	0	0	1	0
3	0	0	0	0	0	0	0	1	1
•	•	•	•	•	•	•	•	•	•
511	1	1	1	1	1	1	1	1	1

R6 REGISTER

The R6 register is used for internal testing of the device and is not intended for customer use. The register address bits are R6[5:0] = 011111. Register R6 is active only when the SPI_DEF bit in Register R0 is set to 0.

Reg	23	22	21	20	19	18	17	16	15	14	13	12	11	10	9	8	7	6	5	4	3	2	1	0
	MSB	SHIFT REGISTER BIT LOCATION																					LSB	
	DATA[17:0] FIELD																	ADDRESS [5:0] FIELD						
R6	0	0	0	0	0	0	0	1	1	1	1	1	1	1	1	1	1	1	0	1	1	1	1	1

REVISION HISTORY

Changes from Revision A (April 2013) to Revision B	Page
• Changed layout of National Data Sheet to TI format	23

IMPORTANT NOTICE

Texas Instruments Incorporated and its subsidiaries (TI) reserve the right to make corrections, enhancements, improvements and other changes to its semiconductor products and services per JESD46, latest issue, and to discontinue any product or service per JESD48, latest issue. Buyers should obtain the latest relevant information before placing orders and should verify that such information is current and complete. All semiconductor products (also referred to herein as "components") are sold subject to TI's terms and conditions of sale supplied at the time of order acknowledgment.

TI warrants performance of its components to the specifications applicable at the time of sale, in accordance with the warranty in TI's terms and conditions of sale of semiconductor products. Testing and other quality control techniques are used to the extent TI deems necessary to support this warranty. Except where mandated by applicable law, testing of all parameters of each component is not necessarily performed.

TI assumes no liability for applications assistance or the design of Buyers' products. Buyers are responsible for their products and applications using TI components. To minimize the risks associated with Buyers' products and applications, Buyers should provide adequate design and operating safeguards.

TI does not warrant or represent that any license, either express or implied, is granted under any patent right, copyright, mask work right, or other intellectual property right relating to any combination, machine, or process in which TI components or services are used. Information published by TI regarding third-party products or services does not constitute a license to use such products or services or a warranty or endorsement thereof. Use of such information may require a license from a third party under the patents or other intellectual property of the third party, or a license from TI under the patents or other intellectual property of TI.

Reproduction of significant portions of TI information in TI data books or data sheets is permissible only if reproduction is without alteration and is accompanied by all associated warranties, conditions, limitations, and notices. TI is not responsible or liable for such altered documentation. Information of third parties may be subject to additional restrictions.

Resale of TI components or services with statements different from or beyond the parameters stated by TI for that component or service voids all express and any implied warranties for the associated TI component or service and is an unfair and deceptive business practice. TI is not responsible or liable for any such statements.

Buyer acknowledges and agrees that it is solely responsible for compliance with all legal, regulatory and safety-related requirements concerning its products, and any use of TI components in its applications, notwithstanding any applications-related information or support that may be provided by TI. Buyer represents and agrees that it has all the necessary expertise to create and implement safeguards which anticipate dangerous consequences of failures, monitor failures and their consequences, lessen the likelihood of failures that might cause harm and take appropriate remedial actions. Buyer will fully indemnify TI and its representatives against any damages arising out of the use of any TI components in safety-critical applications.

In some cases, TI components may be promoted specifically to facilitate safety-related applications. With such components, TI's goal is to help enable customers to design and create their own end-product solutions that meet applicable functional safety standards and requirements. Nonetheless, such components are subject to these terms.

No TI components are authorized for use in FDA Class III (or similar life-critical medical equipment) unless authorized officers of the parties have executed a special agreement specifically governing such use.

Only those TI components which TI has specifically designated as military grade or "enhanced plastic" are designed and intended for use in military/aerospace applications or environments. Buyer acknowledges and agrees that any military or aerospace use of TI components which have **not** been so designated is solely at the Buyer's risk, and that Buyer is solely responsible for compliance with all legal and regulatory requirements in connection with such use.

TI has specifically designated certain components as meeting ISO/TS16949 requirements, mainly for automotive use. In any case of use of non-designated products, TI will not be responsible for any failure to meet ISO/TS16949.

Products

Audio	www.ti.com/audio
Amplifiers	amplifier.ti.com
Data Converters	dataconverter.ti.com
DLP® Products	www.dlp.com
DSP	dsp.ti.com
Clocks and Timers	www.ti.com/clocks
Interface	interface.ti.com
Logic	logic.ti.com
Power Mgmt	power.ti.com
Microcontrollers	microcontroller.ti.com
RFID	www.ti-rfid.com
OMAP Applications Processors	www.ti.com/omap
Wireless Connectivity	www.ti.com/wirelessconnectivity

Applications

Automotive and Transportation	www.ti.com/automotive
Communications and Telecom	www.ti.com/communications
Computers and Peripherals	www.ti.com/computers
Consumer Electronics	www.ti.com/consumer-apps
Energy and Lighting	www.ti.com/energy
Industrial	www.ti.com/industrial
Medical	www.ti.com/medical
Security	www.ti.com/security
Space, Avionics and Defense	www.ti.com/space-avionics-defense
Video and Imaging	www.ti.com/video

TI E2E Community

e2e.ti.com

Looking for pricing, stock, or lifecycle information?

Click below to explore more details on WIN SOURCE:

 [View LMX2542LQ2121/NOPB on WIN SOURCE](#)

 [Texas Instruments](#) Information

Optimize Your Supply Chain with WIN SOURCE Solutions

-  Global Sourcing Solution
-  Obsolete Management
-  Cost Control Management
-  Shortage Management
-  Alternative Solution
-  Excess Inventory Management