



**THE DATASHEET OF
LP2985A-50DBVT**



LP2985 150-mA Low-noise Low-dropout Regulator With Shutdown

1 Features

- Output Tolerance of
 - 1% (A Grade)
 - 1.5% (Standard Grade)
- Ultra-Low Dropout, Typically
 - 280 mV at Full Load of 150 mA
 - 7 mV at 1 mA
- Wide V_{IN} Range: 16 V Max
- Low I_Q : 850 μ A at Full Load at 150 mA
- Shutdown Current: 0.01 μ A Typ
- Low Noise: 30 μ V_{RMS} With 10-nF Bypass Capacitor
- Stable With Low-ESR Capacitors, Including Ceramic
- Overcurrent and Thermal Protection
- High Peak-Current Capability
- ESD Protection Exceeds JESD 22
 - 2000-V Human-Body Model (A114-A)
 - 200-V Machine Model (A115-A)

2 Applications

- Portable Devices
- Digital Cameras and Camcorders
- CD Players
- MP3 Players

3 Description

The LP2985 family of fixed-output, low-dropout regulators offers exceptional, cost-effective performance for both portable and nonportable applications. Available in voltages of 1.8 V, 2.5 V, 2.8 V, 2.9 V, 3 V, 3.1 V, 3.3 V, 5 V, and 10 V, the family has an output tolerance of 1% for the A version (1.5% for the non-A version) and is capable of delivering 150-mA continuous load current. Standard regulator features, such as overcurrent and overtemperature protection, are included.

Device Information⁽¹⁾

PART NUMBER	PACKAGE	BODY SIZE (NOM)
LP2985	SOT-23 (5)	2.90 mm x 1.60 mm

(1) For all available packages, see the orderable addendum at the end of the data sheet.

Dropout Voltage vs Temperature



Table of Contents

1 Features	1	7.2 Functional Block Diagram	11
2 Applications	1	7.3 Feature Description	11
3 Description	1	7.4 Device Functional Modes	11
4 Revision History	2	8 Application and Implementation	12
5 Pin Configuration and Functions	3	8.1 Application Information	12
6 Specifications	4	9 Power Supply Recommendations	16
6.1 Absolute Maximum Ratings	4	10 Layout	17
6.2 ESD Ratings	4	10.1 Layout Guidelines	17
6.3 Recommended Operating Conditions	4	10.2 Layout Example	17
6.4 Thermal Information	4	11 Device and Documentation Support	17
6.5 Electrical Characteristics	5	11.1 Trademarks	17
6.6 Typical Characteristics	7	11.2 Electrostatic Discharge Caution	17
7 Detailed Description	11	11.3 Glossary	17
7.1 Overview	11	12 Mechanical, Packaging, and Orderable Information	17

4 Revision History

Changes from Revision N (June 2011) to Revision O	Page
• Added <i>Applications</i> , <i>Device Information</i> table, <i>Pin Functions</i> table, <i>ESD Ratings</i> table, <i>Thermal Information</i> table, <i>Feature Description</i> section, <i>Device Functional Modes</i> , <i>Application and Implementation</i> section, <i>Power Supply Recommendations</i> section, <i>Layout</i> section, <i>Device and Documentation Support</i> section, and <i>Mechanical, Packaging, and Orderable Information</i> section.	1
• Deleted <i>Ordering Information</i> table.	1

5 Pin Configuration and Functions

DBV (SOT-23) PACKAGE
(TOP VIEW)



Pin Functions

PIN		TYPE	DESCRIPTION
NAME	NO.		
BYPASS	4	I/O	Attach a 10-nF capacitor to improve low-noise performance.
GND	2	—	Ground
ON/OFF	3	I	Active-low shutdown pin. Tie to V_{IN} if unused.
V_{IN}	1	I	Supply input
V_{OUT}	5	O	Voltage output

6 Specifications

6.1 Absolute Maximum Ratings

over virtual junction temperature range (unless otherwise noted)⁽¹⁾

		MIN	MAX	UNIT
V_{IN}	Continuous input voltage range ⁽²⁾	-0.3	16	V
$V_{ON/ \overline{OFF}}$	ON/ \overline{OFF} input voltage range	-0.3	16	V
	Output voltage range ⁽³⁾	-0.3	9	V
I_O	Output current ⁽⁴⁾	Internally limited (short-circuit protected)		—
θ_{JA}	Package thermal impedance ^{(4) (5)}		206	°C/W
T_J	Operating virtual junction temperature		150	°C
T_{stg}	Storage temperature range	-65	150	°C

- (1) Stresses beyond those listed under "absolute maximum ratings" may cause permanent damage to the device. These are stress ratings only, and functional operation of the device at these or any other conditions beyond those indicated under [Recommended Operating Conditions](#) is not implied. Exposure to absolute-maximum-rated conditions for extended periods may affect device reliability.
- (2) The PNP pass transistor has a parasitic diode connected between the input and output. This diode normally is reverse biased ($V_{IN} > V_{OUT}$), but will be forward biased if the output voltage exceeds the input voltage by a diode drop (see [Application Information](#) for more details).
- (3) If load is returned to a negative power supply in a dual-supply system, the output must be diode clamped to GND.
- (4) Maximum power dissipation is a function of $T_J(\max)$, θ_{JA} , and T_A . The maximum allowable power dissipation at any allowable ambient temperature is $P_D = (T_J(\max) - T_A)/\theta_{JA}$. Operating at the absolute maximum T_J of 150°C can affect reliability.
- (5) The package thermal impedance is calculated in accordance with JESD 51-7.

6.2 ESD Ratings

		VALUE	UNIT
$V_{(ESD)}$	Electrostatic discharge		
	Human body model (HBM), per ANSI/ESDA/JEDEC JS-001, all pins ⁽¹⁾	2000	V
Charged device model (CDM), per JEDEC specification JESD22-C101, all pins ⁽²⁾	1000		

- (1) JEDEC document JEP155 states that 500-V HBM allows safe manufacturing with a standard ESD control process.
- (2) JEDEC document JEP157 states that 250-V CDM allows safe manufacturing with a standard ESD control process.

6.3 Recommended Operating Conditions

		MIN	MAX	UNIT
V_{IN}	Supply input voltage	2.2 ⁽¹⁾	16	V
$V_{ON/ \overline{OFF}}$	ON/ \overline{OFF} input voltage	0	V_{IN}	V
I_{OUT}	Output current		150	mA
T_J	Virtual junction temperature	-40	125	°C

- (1) Recommended minimum V_{IN} is the greater of 2.5 V or $V_{OUT(\max)} +$ rated dropout voltage (max) for operating I_L .

6.4 Thermal Information

THERMAL METRIC ⁽¹⁾	LP2985	UNIT	
	DBV		
	5 PINS		
$R_{\theta JA}$	Junction-to-ambient thermal resistance	206	°C/W

- (1) For more information about traditional and new thermal metrics, see the [IC Package Thermal Metrics](#) application report, [SPRA953](#).

6.5 Electrical Characteristics

at specified virtual junction temperature range, $V_{IN} = V_{OUT(NOM)} + 1\text{ V}$, $V_{ON/OFF} = 2\text{ V}$, $C_{IN} = 1\text{ }\mu\text{F}$, $I_L = 1\text{ mA}$, $C_{OUT} = 4.7\text{ }\mu\text{F}$ (unless otherwise noted)

PARAMETER	TEST CONDITIONS	T _J	LP2985A-xx			LP2985-xx			UNIT
			MIN	TYP	MAX	MIN	TYP	MAX	
ΔV_{OUT} Output voltage tolerance	$I_L = 1\text{ mA}$	25°C	-1		1	-1.5		1.5	%V _{NOM}
	$1\text{ mA} \leq I_L \leq 50\text{ mA}$	25°C	-1.5		1.5	-2.5		2.5	
		-40°C to 125°C	-2.5		2.5	-3.5		3.5	
	$1\text{ mA} \leq I_L \leq 150\text{ mA}$	25°C	-2.5		2.5	-3		3	
-40°C to 125°C		-3.5		3.5	-4		4		
Line regulation	$V_{IN} = [V_{OUT(NOM)} + 1\text{ V}]$ to 16 V	25°C		0.007	0.014		0.007	0.014	%V
		-40°C to 125°C			0.032			0.032	
$V_{IN} - V_{OUT}$ Dropout voltage ⁽¹⁾	$I_L = 0$	25°C		1	3		1	3	mV
		-40°C to 125°C			5			5	
	$I_L = 1\text{ mA}$	25°C		7	10		7	10	
		-40°C to 125°C			15			15	
	$I_L = 10\text{ mA}$	25°C		40	60		40	60	
		-40°C to 125°C			90			90	
	$I_L = 50\text{ mA}$	25°C		120	150		120	150	
		-40°C to 125°C			225			225	
	$I_L = 150\text{ mA}$	25°C		280	350		280	350	
		-40°C to 125°C			575			575	
I_{GND} GND pin current	$I_L = 0$	25°C		65	95		65	95	μA
		25°C (LP2985-10)			125			125	
		-40°C to 125°C			125			125	
		-40°C to 125°C (LP2985-10)			160			160	
	$I_L = 1\text{ mA}$	25°C		75	110		75	110	
		25°C (LP2985-10)			140			140	
		-40°C to 125°C			170			170	
	$I_L = 10\text{ mA}$	25°C		120	220		120	220	
		25°C (LP2985-10)			250			250	
		-40°C to 125°C			400			400	
	$I_L = 50\text{ mA}$	25°C		350	600		350	600	
		25°C (LP2985-10)			650			650	
		-40°C to 125°C			1000			1000	
	$I_L = 150\text{ mA}$	25°C		850	1500		850	1500	
		25°C (LP2985-10)			1800			1800	
		-40°C to 125°C			2500			2500	
$V_{ON/OFF} < 0.3\text{ V}$ (OFF)	25°C		0.01	0.8		0.01	0.8		
	-40°C to 105°C			0.05		0.05	2		
	-40°C to 125°C						5		
$V_{ON/OFF}$ ON/OFF input voltage ⁽²⁾	$V_{ON/OFF} = \text{HIGH} \rightarrow \text{O/P ON}$	25°C		1.4			1.4	V	
		-40°C to 125°C		1.6			1.6		
	$V_{ON/OFF} = \text{LOW} \rightarrow \text{O/P OFF}$	25°C		0.55			0.55		
		-40°C to 125°C			0.15				0.15
$I_{ON/OFF}$ ON/OFF input current	$V_{ON/OFF} = 0$	25°C		0.01			0.01	μA	
		-40°C to 125°C			-2		-2		
	$V_{ON/OFF} = 5\text{ V}$	25°C		5			5		
		-40°C to 125°C			15				15

(1) Dropout voltage is defined as the input-to-output differential at which the output voltage drops 100 mV below the value measured with a 1-V differential.

(2) The ON/OFF input must be driven properly for reliable operation (see *Application Information*).

Electrical Characteristics (continued)

at specified virtual junction temperature range, $V_{IN} = V_{OUT(NOM)} + 1\text{ V}$, $V_{ON/OFF} = 2\text{ V}$, $C_{IN} = 1\text{ }\mu\text{F}$, $I_L = 1\text{ mA}$, $C_{OUT} = 4.7\text{ }\mu\text{F}$ (unless otherwise noted)

PARAMETER	TEST CONDITIONS	T_J	LP2985A-xx			LP2985-xx			UNIT
			MIN	TYP	MAX	MIN	TYP	MAX	
V_n Output noise (RMS)	BW = 300 Hz to 50 kHz, $C_{OUT} = 10\text{ }\mu\text{F}$, $C_{BYPASS} = 10\text{ nF}$	25°C		30			30		μV
$\frac{\Delta V_{OUT}}{\Delta V_{IN}}$ Ripple rejection	$f = 1\text{ kHz}$, $C_{OUT} = 10\text{ }\mu\text{F}$, $C_{BYPASS} = 10\text{ nF}$	25°C		45			45		dB
$I_{OUT(PK)}$ Peak output current	$V_{OUT} \geq V_{O(NOM)} - 5\%$	25°C		350			350		mA
$I_{OUT(SC)}$ Short-circuit current	$R_L = 0$ (steady state) ⁽³⁾	25°C		400			400		mA

(3) See [Figure 6](#) in *Typical Performance Characteristics*.

6.6 Typical Characteristics

$C_{IN} = 1 \mu\text{F}$, $C_{OUT} = 4.7 \mu\text{F}$, $V_{IN} = V_{OUT(NOM)} + 1 \text{ V}$, $T_A = 25^\circ\text{C}$, ON/OFF pin tied to V_{IN} (unless otherwise specified)

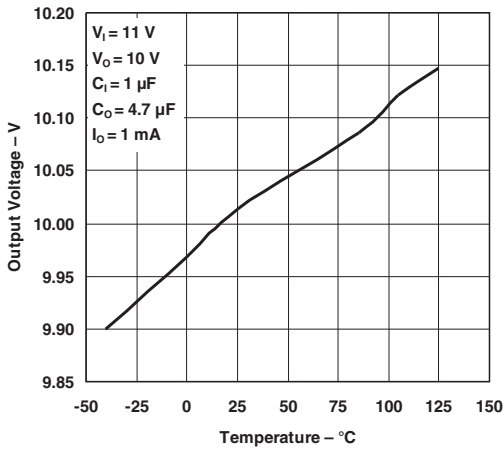

Figure 1. Output Voltage vs Temperature

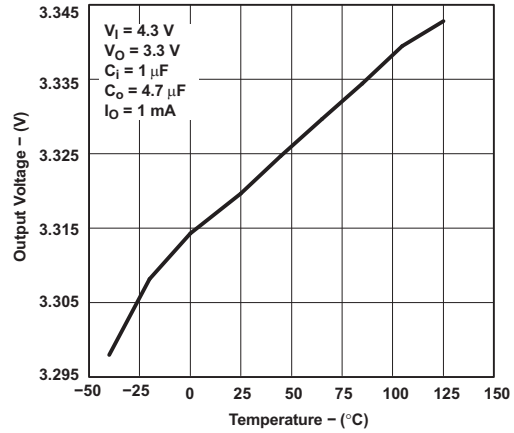

Figure 2. Output Voltage vs Temperature

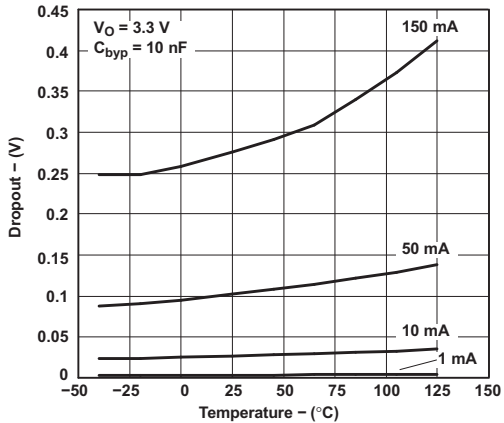

Figure 3. Dropout Voltage vs Temperature

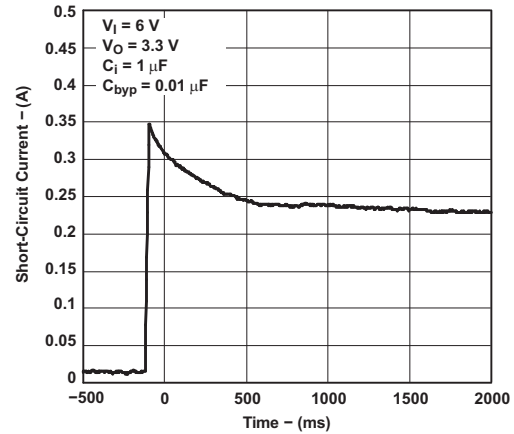

Figure 4. Short-circuit Current vs Time

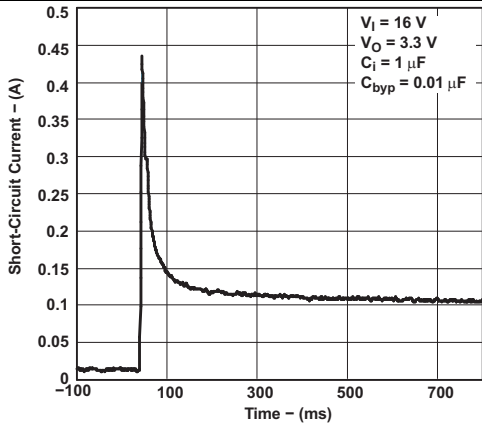

Figure 5. Short-circuit Current vs Time

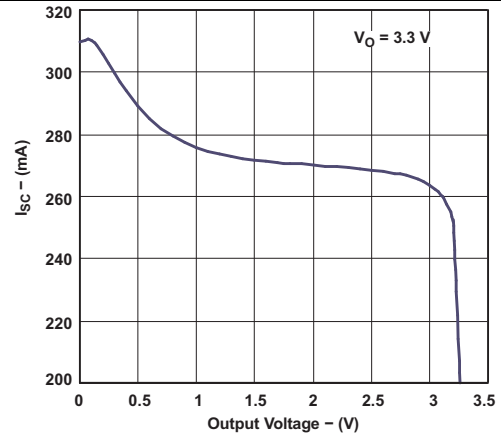

Figure 6. Short-circuit Current vs Output Voltage

Typical Characteristics (continued)

$C_{IN} = 1 \mu\text{F}$, $C_{OUT} = 4.7 \mu\text{F}$, $V_{IN} = V_{OUT(NOM)} + 1 \text{ V}$, $T_A = 25^\circ\text{C}$, ON/OFF pin tied to V_{IN} (unless otherwise specified)



Figure 7. Ground Pin Current vs Load Current



Figure 8. Ripple Rejection vs Frequency



Figure 9. Ripple Rejection vs Frequency



Figure 10. Ripple Rejection vs Frequency

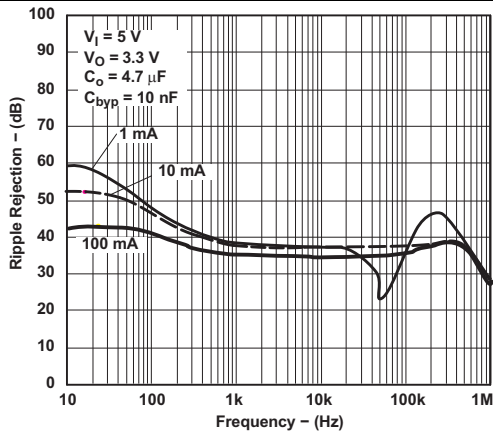

Figure 11. Ripple Rejection vs Frequency



Figure 12. Output Impedance vs Frequency

Typical Characteristics (continued)

$C_{IN} = 1 \mu\text{F}$, $C_{OUT} = 4.7 \mu\text{F}$, $V_{IN} = V_{OUT(NOM)} + 1 \text{ V}$, $T_A = 25^\circ\text{C}$, ON/OFF pin tied to V_{IN} (unless otherwise specified)

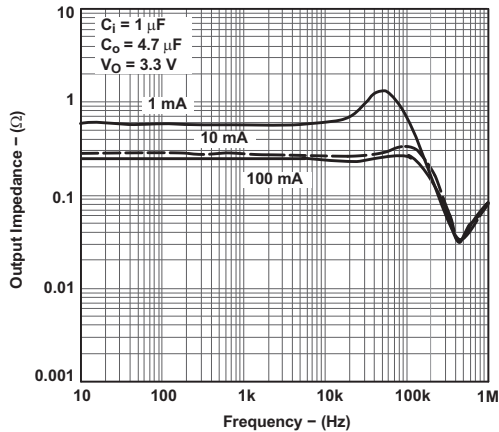

Figure 13. Output Impedance vs Frequency



Figure 14. Output Noise Density vs Frequency

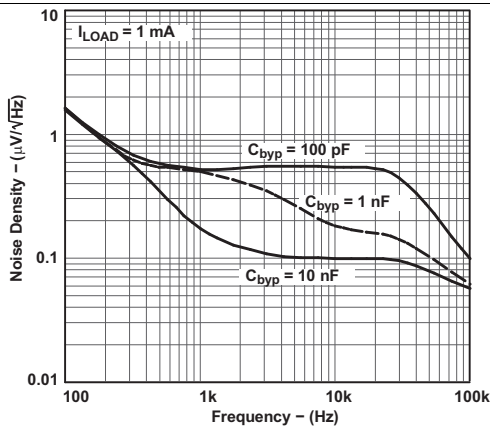

Figure 15. Output Noise Density vs Frequency

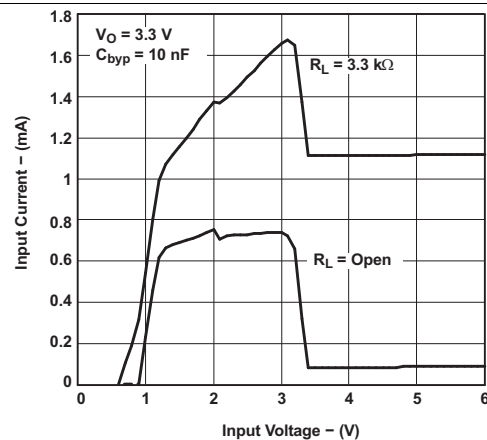

Figure 16. Input Current vs Input Voltage

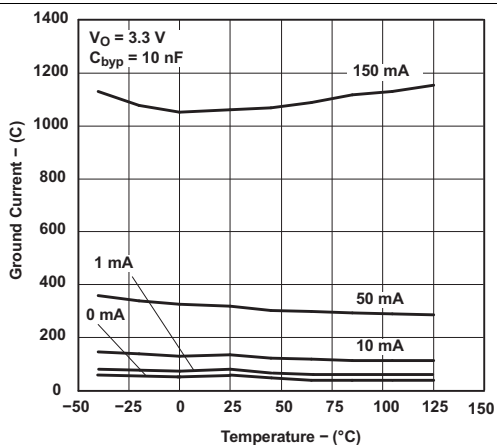

Figure 17. Ground-pin Current vs Temperature

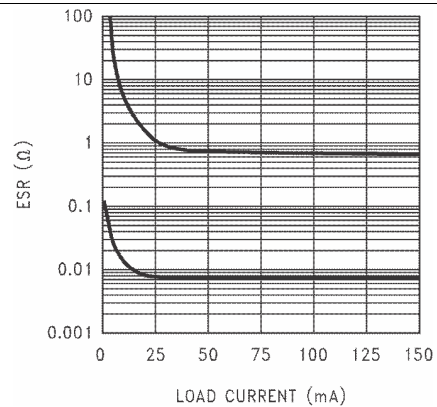

Figure 18. 2.2- μF Stable ESR Range for Output Voltage $\leq 2.3 \text{ V}$

Typical Characteristics (continued)

$C_{IN} = 1 \mu F$, $C_{OUT} = 4.7 \mu F$, $V_{IN} = V_{OUT(NOM)} + 1 V$, $T_A = 25^\circ C$, ON/OFF pin tied to V_{IN} (unless otherwise specified)

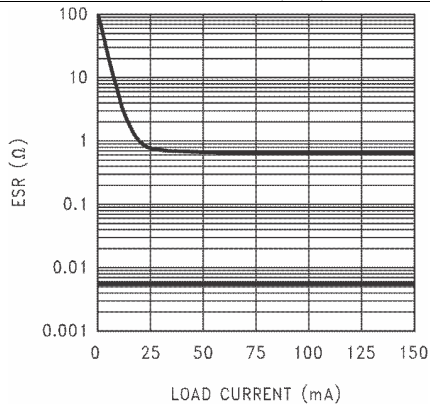

Figure 19. 4.7- μF Stable ESR Range for Output Voltage $\leq 2.3 V$



Figure 20. 2.2- μF /3.3- μF Stable ESR Range for Output Voltage $\geq 2.5 V$

7 Detailed Description

7.1 Overview

The LP2985 family of fixed-output, low-dropout regulators offers exceptional, cost-effective performance for both portable and nonportable applications. Available in voltages of 1.8 V, 2.5 V, 2.8 V, 2.9 V, 3 V, 3.1 V, 3.3 V, 5 V, and 10 V, the family has an output tolerance of 1% for the A version (1.5% for the non-A version) and is capable of delivering 150-mA continuous load current. Standard regulator features, such as overcurrent and overtemperature protection, are included.

7.2 Functional Block Diagram

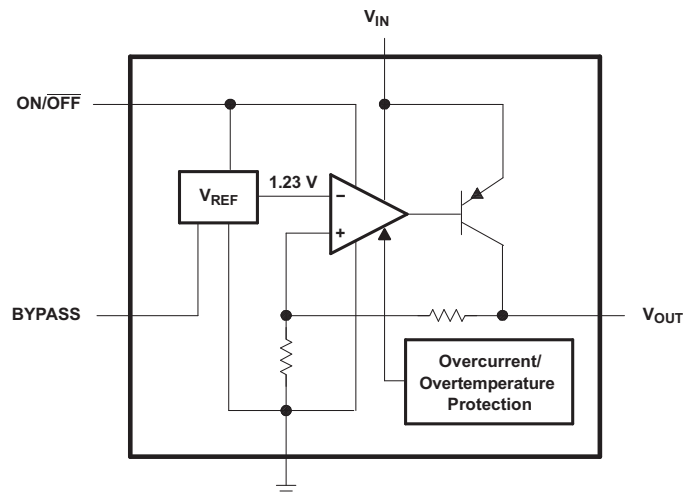

7.3 Feature Description

The LP2985 has a host of features that makes the regulator an ideal candidate for a variety of portable applications:

- Low dropout: A PNP pass element allows a typical dropout of 280 mV at 150-mA load current and 7 mV at 1-mA load.
- Low quiescent current: The use of a vertical PNP process allows for quiescent currents that are considerably lower than those associated with traditional lateral PNP regulators.
- Shutdown: A shutdown feature is available, allowing the regulator to consume only 0.01 μA when the $\text{ON}/\overline{\text{OFF}}$ pin is pulled low.
- Low-ESR-capacitor friendly: The regulator is stable with low-ESR capacitors, allowing the use of small, inexpensive, ceramic capacitors in cost-sensitive applications.
- Low noise: A BYPASS pin allows for low-noise operation, with a typical output noise of 30 μV_{RMS} , with the use of a 10-nF bypass capacitor.
- Small packaging: For the most space-constrained needs, the regulator is available in the SOT-23 package.

7.4 Device Functional Modes

7.4.1 Normal Operation

In normal operation, the device will output a fixed voltage corresponding with the orderable part number. The device can deliver 150 mA of continuous load current.

7.4.2 Shutdown Mode

Set the $\text{ON}/\overline{\text{OFF}}$ pin low to shut down the device when V_{IN} is still present. If a shutdown mode is not needed, tie the pin to V_{IN} . For proper operation, do not leave $\text{ON}/\overline{\text{OFF}}$ unconnected, and apply a signal with a slew rate of $\geq 40 \text{ mV}/\mu\text{s}$.

8 Application and Implementation

NOTE

Information in the following applications sections is not part of the TI component specification, and TI does not warrant its accuracy or completeness. TI's customers are responsible for determining suitability of components for their purposes. Customers should validate and test their design implementation to confirm system functionality.

8.1 Application Information

The following application schematic shows the standard usage of the LP2985 as a low-dropout regulator.

8.1.1 Typical Application



8.1.2 Design Requirements

Minimum C_{OUT} value for stability (can be increased without limit for improved stability and transient response)

$\overline{ON/OFF}$ must be actively terminated. Connect to V_{IN} if shutdown feature is not used.

Optional BYPASS capacitor for low-noise operation

8.1.3 Capacitors

8.1.3.1 Input Capacitor (C_{IN})

A minimum value of 1 μF (over the entire operating temperature range) is required at the input of the LP2985. In addition, this input capacitor should be located within 1 cm of the input pin and connected to a clean analog ground. There are no equivalent series resistance (ESR) requirements for this capacitor, and the capacitance can be increased without limit.

Application Information (continued)

8.1.3.2 Output Capacitor (C_{OUT})

As an advantage over other regulators, the LP2985 permits the use of low-ESR capacitors at the output, including ceramic capacitors that can have an ESR as low as 5 m Ω . Tantalum and film capacitors also can be used if size and cost are not issues. The output capacitor also should be located within 1 cm of the output pin and be returned to a clean analog ground.

As with other PNP LDOs, stability conditions require the output capacitor to have a minimum capacitance and an ESR that falls within a certain range.

- Minimum C_{OUT} : 2.2 μ F (can be increased without limit to improve transient response stability margin)
- ESR range: see [Figure 18](#) through [Figure 20](#)

It is critical that both the minimum capacitance and ESR requirement be met *over the entire operating temperature range*. Depending on the type of capacitors used, both these parameters can vary significantly with temperature (see *capacitor characteristics*).

8.1.3.3 Noise Bypass Capacitor (C_{BYPASS})

The LP2985 allows for low-noise performance with the use of a bypass capacitor that is connected to the internal bandgap reference via the BYPASS pin. This high-impedance bandgap circuitry is biased in the microampere range and, thus, cannot be loaded significantly, otherwise, its output – and, correspondingly, the output of the regulator – changes. Thus, for best output accuracy, dc leakage current through C_{BYPASS} should be minimized as much as possible and never should exceed 100 nA.

A 10-nF capacitor is recommended for C_{BYPASS} . Ceramic and film capacitors are well suited for this purpose.

8.1.3.4 Reverse Input-Output Voltage

There is an inherent diode present across the PNP pass element of the LP2985.



With the anode connected to the output, this diode is reverse biased during normal operation, since the input voltage is higher than the output. However, if the output is pulled higher than the input for any reason, this diode is forward biased and can cause a parasitic silicon-controlled rectifier (SCR) to latch, resulting in high current flowing from the output to the input. Thus, to prevent possible damage to the regulator in any application where the output may be pulled above the input, or the input may be shorted to ground, an external Schottky diode should be connected between the output and input. With the anode on output, this Schottky limits the reverse voltage across the output and input pins to ~0.3 V, preventing the regulator's internal diode from forward biasing.



Application Information (continued)

8.1.4 Detailed Design Procedure

8.1.4.1 Capacitor Characteristics

8.1.4.1.1 Ceramics

Ceramic capacitors are ideal choices for use on the output of the LP2985 for several reasons. For capacitances in the range of 2.2 μF to 4.7 μF , ceramic capacitors have the lowest cost and the lowest ESR, making them choice candidates for filtering high-frequency noise. For instance, a typical 2.2- μF ceramic capacitor has an ESR in the range of 10 m Ω to 20 m Ω and, thus, satisfies minimum ESR requirements of the regulator.

Ceramic capacitors have one major disadvantage that must be taken into account – a poor temperature coefficient, where the capacitance can vary significantly with temperature. For instance, a large-value ceramic capacitor ($\geq 2.2 \mu\text{F}$) can lose more than half of its capacitance as the temperature rises from 25°C to 85°C. Thus, a 2.2- μF capacitor at 25°C drops well below the minimum C_{OUT} required for stability, as ambient temperature rises. For this reason, select an output capacitor that maintains the minimum 2.2 μF required for stability over the entire operating temperature range. Note that there are some ceramic capacitors that can maintain a $\pm 15\%$ capacitance tolerance over temperature.

8.1.4.1.2 Tantalum

Tantalum capacitors can be used at the output of the LP2985, but there are significant disadvantages that could prohibit their use:

- In the 1- μF to 4.7- μF range, tantalum capacitors are more expensive than ceramics of the equivalent capacitance and voltage ratings.
- Tantalum capacitors have higher ESRs than their equivalent-sized ceramic counterparts. Thus, to meet the ESR requirements, a higher-capacitance tantalum may be required, at the expense of larger size and higher cost.
- The ESR of a tantalum capacitor increases as temperature drops, as much as double from 25°C to –40°C. Thus, ESR margins must be maintained over the temperature range to prevent regulator instability.

8.1.4.2 ON/OFF Operation

The LP2985 allows for a shutdown mode via the ON/OFF pin. Driving the pin LOW ($\leq 0.3 \text{ V}$) turns the device OFF; conversely, a HIGH ($\geq 1.6 \text{ V}$) turns the device ON. If the shutdown feature is not used, ON/OFF should be connected to the input to ensure that the regulator is on at all times. For proper operation, do not leave ON/OFF unconnected, and apply a signal with a slew rate of $\geq 40 \text{ mV}/\mu\text{s}$.

8.1.5 Application Curves



Application Information (continued)



Figure 23. Load Transient Response



Figure 24. Line Transient Response



Figure 25. Line Transient Response



Figure 26. Line Transient Response



Figure 27. Line Transient Response



Figure 28. Turn-on Time

Application Information (continued)



9 Power Supply Recommendations

A power supply may be used at the input voltage within the ranges given in the *Recommended Operating Conditions* table. It is recommended to use bypass capacitors as described in *Layout Guidelines*.

10 Layout

10.1 Layout Guidelines

- It is recommended that the input pin be bypassed to ground with a bypass-capacitor.
- The optimum placement of the bypass capacitor is closest to the V_{IN} of the device and GND of the system. Care must be taken to minimize the loop area formed by the bypass-capacitor connection, the V_{IN} pin, and the GND pin of the system.
- For operation at full-rated load, it is recommended to use wide trace lengths to eliminate IR drop and heat dissipation.

10.2 Layout Example

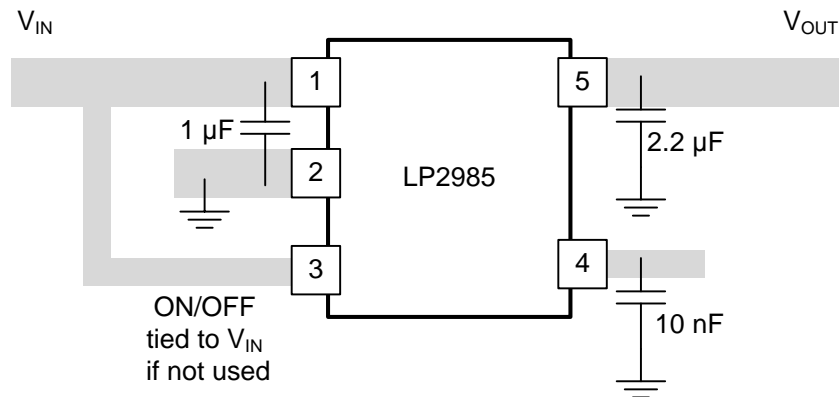

Figure 32. Layout Diagram

11 Device and Documentation Support

11.1 Trademarks

All trademarks are the property of their respective owners.

11.2 Electrostatic Discharge Caution



These devices have limited built-in ESD protection. The leads should be shorted together or the device placed in conductive foam during storage or handling to prevent electrostatic damage to the MOS gates.

11.3 Glossary

[SLYZ022](#) — *TI Glossary*.

This glossary lists and explains terms, acronyms, and definitions.

12 Mechanical, Packaging, and Orderable Information

The following pages include mechanical, packaging, and orderable information. This information is the most current data available for the designated devices. This data is subject to change without notice and revision of this document. For browser-based versions of this data sheet, refer to the left-hand navigation.

PACKAGING INFORMATION

Orderable Device	Status (1)	Package Type	Package Drawing	Pins	Package Qty	Eco Plan (2)	Lead/Ball Finish (6)	MSL Peak Temp (3)	Op Temp (°C)	Device Marking (4/5)	Samples
LP2985-10DBVR	ACTIVE	SOT-23	DBV	5	3000	Green (RoHS & no Sb/Br)	CU NIPDAU	Level-1-260C-UNLIM	-40 to 125	LRCG	Samples
LP2985-10DBVT	ACTIVE	SOT-23	DBV	5	250	Green (RoHS & no Sb/Br)	CU NIPDAU	Level-1-260C-UNLIM	-40 to 125	LRCG	Samples
LP2985-18DBVR	ACTIVE	SOT-23	DBV	5	3000	Green (RoHS & no Sb/Br)	CU NIPDAU CU SN	Level-1-260C-UNLIM	-40 to 125	(LPHG, LPHL)	Samples
LP2985-18DBVRE4	ACTIVE	SOT-23	DBV	5	3000	Green (RoHS & no Sb/Br)	CU NIPDAU	Level-1-260C-UNLIM	-40 to 125	LPHG	Samples
LP2985-18DBVRG4	ACTIVE	SOT-23	DBV	5	3000	Green (RoHS & no Sb/Br)	CU NIPDAU	Level-1-260C-UNLIM	-40 to 125	LPHG	Samples
LP2985-18DBVT	ACTIVE	SOT-23	DBV	5	250	Green (RoHS & no Sb/Br)	CU NIPDAU CU SN	Level-1-260C-UNLIM	-40 to 125	(LPHG, LPHL)	Samples
LP2985-18DBVTE4	ACTIVE	SOT-23	DBV	5	250	Green (RoHS & no Sb/Br)	CU NIPDAU	Level-1-260C-UNLIM	-40 to 125	LPHG	Samples
LP2985-18DBVTG4	ACTIVE	SOT-23	DBV	5	250	Green (RoHS & no Sb/Br)	CU NIPDAU	Level-1-260C-UNLIM	-40 to 125	LPHG	Samples
LP2985-25DBVR	ACTIVE	SOT-23	DBV	5	3000	Green (RoHS & no Sb/Br)	CU NIPDAU	Level-1-260C-UNLIM	-40 to 125	(LPLG, LPLL)	Samples
LP2985-25DBVT	ACTIVE	SOT-23	DBV	5	250	Green (RoHS & no Sb/Br)	CU NIPDAU	Level-1-260C-UNLIM	-40 to 125	(LPLG, LPLL)	Samples
LP2985-28DBVR	ACTIVE	SOT-23	DBV	5	3000	Green (RoHS & no Sb/Br)	CU NIPDAU CU SN	Level-1-260C-UNLIM	-40 to 125	(LPGG, LPGL)	Samples
LP2985-28DBVT	ACTIVE	SOT-23	DBV	5	250	Green (RoHS & no Sb/Br)	CU NIPDAU CU SN	Level-1-260C-UNLIM	-40 to 125	(LPGG, LPGL)	Samples
LP2985-28DBVTG4	ACTIVE	SOT-23	DBV	5	250	Green (RoHS & no Sb/Br)	CU NIPDAU	Level-1-260C-UNLIM	-40 to 125	LPGG	Samples
LP2985-29DBVR	ACTIVE	SOT-23	DBV	5	3000	Green (RoHS & no Sb/Br)	CU NIPDAU	Level-1-260C-UNLIM	-40 to 125	(LPMG, LPML)	Samples
LP2985-30DBVR	ACTIVE	SOT-23	DBV	5	3000	Green (RoHS & no Sb/Br)	CU NIPDAU	Level-1-260C-UNLIM	-40 to 125	(LPNG, LPNL)	Samples
LP2985-30DBVRG4	ACTIVE	SOT-23	DBV	5	3000	Green (RoHS & no Sb/Br)	CU NIPDAU	Level-1-260C-UNLIM	-40 to 125	(LPNG, LPNL)	Samples
LP2985-30DBVT	ACTIVE	SOT-23	DBV	5	250	Green (RoHS & no Sb/Br)	CU NIPDAU	Level-1-260C-UNLIM	-40 to 125	(LPNG, LPNL)	Samples

Orderable Device	Status (1)	Package Type	Package Drawing	Pins	Package Qty	Eco Plan (2)	Lead/Ball Finish (6)	MSL Peak Temp (3)	Op Temp (°C)	Device Marking (4/5)	Samples
LP2985-30DBVTG4	ACTIVE	SOT-23	DBV	5	250	Green (RoHS & no Sb/Br)	CU NIPDAU	Level-1-260C-UNLIM	-40 to 125	(LPNG, LPNL)	Samples
LP2985-33DBVR	ACTIVE	SOT-23	DBV	5	3000	Green (RoHS & no Sb/Br)	CU NIPDAU CU SN	Level-1-260C-UNLIM	-40 to 125	(LPFG, LPFL)	Samples
LP2985-33DBVRE4	ACTIVE	SOT-23	DBV	5	3000	Green (RoHS & no Sb/Br)	CU NIPDAU	Level-1-260C-UNLIM	-40 to 125	LPFG	Samples
LP2985-33DBVRG4	ACTIVE	SOT-23	DBV	5	3000	Green (RoHS & no Sb/Br)	CU NIPDAU	Level-1-260C-UNLIM	-40 to 125	LPFG	Samples
LP2985-33DBVT	ACTIVE	SOT-23	DBV	5	250	Green (RoHS & no Sb/Br)	CU NIPDAU CU SN	Level-1-260C-UNLIM	-40 to 125	(LPFG, LPFL)	Samples
LP2985-33DBVTE4	ACTIVE	SOT-23	DBV	5	250	Green (RoHS & no Sb/Br)	CU NIPDAU	Level-1-260C-UNLIM	-40 to 125	LPFG	Samples
LP2985-33DBVTG4	ACTIVE	SOT-23	DBV	5	250	Green (RoHS & no Sb/Br)	CU NIPDAU	Level-1-260C-UNLIM	-40 to 125	LPFG	Samples
LP2985-50DBVR	ACTIVE	SOT-23	DBV	5	3000	Green (RoHS & no Sb/Br)	CU NIPDAU	Level-1-260C-UNLIM	-40 to 125	(LPSG, LPSL)	Samples
LP2985-50DBVRG4	ACTIVE	SOT-23	DBV	5	3000	Green (RoHS & no Sb/Br)	CU NIPDAU	Level-1-260C-UNLIM	-40 to 125	(LPSG, LPSL)	Samples
LP2985-50DBVT	ACTIVE	SOT-23	DBV	5	250	Green (RoHS & no Sb/Br)	CU NIPDAU	Level-1-260C-UNLIM	-40 to 125	(LPSG, LPSL)	Samples
LP2985-50DBVTG4	ACTIVE	SOT-23	DBV	5	250	Green (RoHS & no Sb/Br)	CU NIPDAU	Level-1-260C-UNLIM	-40 to 125	(LPSG, LPSL)	Samples
LP2985A-10DBVR	ACTIVE	SOT-23	DBV	5	3000	Green (RoHS & no Sb/Br)	CU NIPDAU	Level-1-260C-UNLIM	-40 to 125	LRDG	Samples
LP2985A-10DBVT	ACTIVE	SOT-23	DBV	5	250	Green (RoHS & no Sb/Br)	CU NIPDAU	Level-1-260C-UNLIM	-40 to 125	LRDG	Samples
LP2985A-18DBVJ	ACTIVE	SOT-23	DBV	5	10000	Green (RoHS & no Sb/Br)	CU NIPDAU	Level-1-260C-UNLIM	-40 to 125	LPTL	Samples
LP2985A-18DBVR	ACTIVE	SOT-23	DBV	5	3000	Green (RoHS & no Sb/Br)	CU NIPDAU CU SN	Level-1-260C-UNLIM	-40 to 125	(LPTG, LPTL)	Samples
LP2985A-18DBVRG4	ACTIVE	SOT-23	DBV	5	3000	Green (RoHS & no Sb/Br)	CU NIPDAU	Level-1-260C-UNLIM	-40 to 125	LPTG	Samples
LP2985A-18DBVT	ACTIVE	SOT-23	DBV	5	250	Green (RoHS & no Sb/Br)	CU NIPDAU CU SN	Level-1-260C-UNLIM	-40 to 125	(LPTG, LPTL)	Samples
LP2985A-25DBVR	ACTIVE	SOT-23	DBV	5	3000	Green (RoHS & no Sb/Br)	CU NIPDAU	Level-1-260C-UNLIM	-40 to 125	(LPUG, LPUL)	Samples

Orderable Device	Status (1)	Package Type	Package Drawing	Pins	Package Qty	Eco Plan (2)	Lead/Ball Finish (6)	MSL Peak Temp (3)	Op Temp (°C)	Device Marking (4/5)	Samples
LP2985A-25DBVRG4	ACTIVE	SOT-23	DBV	5	3000	Green (RoHS & no Sb/Br)	CU NIPDAU	Level-1-260C-UNLIM	-40 to 125	(LPUG, LPUL)	Samples
LP2985A-25DBVT	ACTIVE	SOT-23	DBV	5	250	Green (RoHS & no Sb/Br)	CU NIPDAU	Level-1-260C-UNLIM	-40 to 125	(LPUG, LPUL)	Samples
LP2985A-28DBVR	ACTIVE	SOT-23	DBV	5	3000	Green (RoHS & no Sb/Br)	CU NIPDAU CU SN	Level-1-260C-UNLIM	-40 to 125	(LPJG, LPJL)	Samples
LP2985A-28DBVT	ACTIVE	SOT-23	DBV	5	250	Green (RoHS & no Sb/Br)	CU NIPDAU CU SN	Level-1-260C-UNLIM	-40 to 125	(LPJG, LPJL)	Samples
LP2985A-29DBVR	ACTIVE	SOT-23	DBV	5	3000	Green (RoHS & no Sb/Br)	CU NIPDAU	Level-1-260C-UNLIM	-40 to 125	(LPZG, LPZL)	Samples
LP2985A-30DBVR	ACTIVE	SOT-23	DBV	5	3000	Green (RoHS & no Sb/Br)	CU NIPDAU	Level-1-260C-UNLIM	-40 to 125	(LRAG, LRAL)	Samples
LP2985A-30DBVT	ACTIVE	SOT-23	DBV	5	250	Green (RoHS & no Sb/Br)	CU NIPDAU	Level-1-260C-UNLIM	-40 to 125	(LRAG, LRAL)	Samples
LP2985A-33DBVR	ACTIVE	SOT-23	DBV	5	3000	Green (RoHS & no Sb/Br)	CU NIPDAU CU SN	Level-1-260C-UNLIM	-40 to 125	(LPKG, LPKL)	Samples
LP2985A-33DBVRG4	ACTIVE	SOT-23	DBV	5	3000	Green (RoHS & no Sb/Br)	CU NIPDAU	Level-1-260C-UNLIM	-40 to 125	LPKG	Samples
LP2985A-33DBVT	ACTIVE	SOT-23	DBV	5	250	Green (RoHS & no Sb/Br)	CU NIPDAU CU SN	Level-1-260C-UNLIM	-40 to 125	(LPKG, LPKL)	Samples
LP2985A-33DBVTE4	ACTIVE	SOT-23	DBV	5	250	Green (RoHS & no Sb/Br)	CU NIPDAU	Level-1-260C-UNLIM	-40 to 125	LPKG	Samples
LP2985A-33DBVTG4	ACTIVE	SOT-23	DBV	5	250	Green (RoHS & no Sb/Br)	CU NIPDAU	Level-1-260C-UNLIM	-40 to 125	LPKG	Samples
LP2985A-50DBVR	ACTIVE	SOT-23	DBV	5	3000	Green (RoHS & no Sb/Br)	CU NIPDAU	Level-1-260C-UNLIM	-40 to 125	(LR1G, LR1L)	Samples
LP2985A-50DBVRG4	ACTIVE	SOT-23	DBV	5	3000	Green (RoHS & no Sb/Br)	CU NIPDAU	Level-1-260C-UNLIM	-40 to 125	(LR1G, LR1L)	Samples
LP2985A-50DBVT	ACTIVE	SOT-23	DBV	5	250	Green (RoHS & no Sb/Br)	CU NIPDAU	Level-1-260C-UNLIM	-40 to 125	(LR1G, LR1L)	Samples

(1) The marketing status values are defined as follows:

ACTIVE: Product device recommended for new designs.

LIFEBUY: TI has announced that the device will be discontinued, and a lifetime-buy period is in effect.

NRND: Not recommended for new designs. Device is in production to support existing customers, but TI does not recommend using this part in a new design.

PREVIEW: Device has been announced but is not in production. Samples may or may not be available.

OBSOLETE: TI has discontinued the production of the device.

⁽²⁾ **RoHS:** TI defines "RoHS" to mean semiconductor products that are compliant with the current EU RoHS requirements for all 10 RoHS substances, including the requirement that RoHS substance do not exceed 0.1% by weight in homogeneous materials. Where designed to be soldered at high temperatures, "RoHS" products are suitable for use in specified lead-free processes. TI may reference these types of products as "Pb-Free".

RoHS Exempt: TI defines "RoHS Exempt" to mean products that contain lead but are compliant with EU RoHS pursuant to a specific EU RoHS exemption.

Green: TI defines "Green" to mean the content of Chlorine (Cl) and Bromine (Br) based flame retardants meet JS709B low halogen requirements of ≤ 1000 ppm threshold. Antimony trioxide based flame retardants must also meet the ≤ 1000 ppm threshold requirement.

⁽³⁾ **MSL, Peak Temp.** - The Moisture Sensitivity Level rating according to the JEDEC industry standard classifications, and peak solder temperature.

⁽⁴⁾ There may be additional marking, which relates to the logo, the lot trace code information, or the environmental category on the device.

⁽⁵⁾ Multiple Device Markings will be inside parentheses. Only one Device Marking contained in parentheses and separated by a "-" will appear on a device. If a line is indented then it is a continuation of the previous line and the two combined represent the entire Device Marking for that device.

⁽⁶⁾ **Lead/Ball Finish** - Orderable Devices may have multiple material finish options. Finish options are separated by a vertical ruled line. Lead/Ball Finish values may wrap to two lines if the finish value exceeds the maximum column width.

Important Information and Disclaimer: The information provided on this page represents TI's knowledge and belief as of the date that it is provided. TI bases its knowledge and belief on information provided by third parties, and makes no representation or warranty as to the accuracy of such information. Efforts are underway to better integrate information from third parties. TI has taken and continues to take reasonable steps to provide representative and accurate information but may not have conducted destructive testing or chemical analysis on incoming materials and chemicals. TI and TI suppliers consider certain information to be proprietary, and thus CAS numbers and other limited information may not be available for release.

In no event shall TI's liability arising out of such information exceed the total purchase price of the TI part(s) at issue in this document sold by TI to Customer on an annual basis.

TAPE AND REEL INFORMATION

QUADRANT ASSIGNMENTS FOR PIN 1 ORIENTATION IN TAPE

*All dimensions are nominal

Device	Package Type	Package Drawing	Pins	SPQ	Reel Diameter (mm)	Reel Width W1 (mm)	A0 (mm)	B0 (mm)	K0 (mm)	P1 (mm)	W (mm)	Pin1 Quadrant
LP2985-10DBVR	SOT-23	DBV	5	3000	178.0	9.0	3.23	3.17	1.37	4.0	8.0	Q3
LP2985-10DBVT	SOT-23	DBV	5	250	178.0	9.0	3.3	3.2	1.4	4.0	8.0	Q3
LP2985-18DBVR	SOT-23	DBV	5	3000	178.0	9.0	3.3	3.2	1.4	4.0	8.0	Q3
LP2985-18DBVRG4	SOT-23	DBV	5	3000	178.0	9.0	3.3	3.2	1.4	4.0	8.0	Q3
LP2985-18DBVTG4	SOT-23	DBV	5	250	178.0	9.0	3.23	3.17	1.37	4.0	8.0	Q3
LP2985-25DBVR	SOT-23	DBV	5	3000	178.0	9.0	3.3	3.2	1.4	4.0	8.0	Q3
LP2985-28DBVR	SOT-23	DBV	5	3000	178.0	9.0	3.23	3.17	1.37	4.0	8.0	Q3
LP2985-28DBVTG4	SOT-23	DBV	5	250	178.0	9.0	3.3	3.2	1.4	4.0	8.0	Q3
LP2985-29DBVR	SOT-23	DBV	5	3000	178.0	9.0	3.23	3.17	1.37	4.0	8.0	Q3
LP2985-30DBVR	SOT-23	DBV	5	3000	178.0	9.0	3.23	3.17	1.37	4.0	8.0	Q3
LP2985-33DBVR	SOT-23	DBV	5	3000	178.0	9.0	3.3	3.2	1.4	4.0	8.0	Q3
LP2985-33DBVRG4	SOT-23	DBV	5	3000	178.0	9.0	3.3	3.2	1.4	4.0	8.0	Q3
LP2985-33DBVT	SOT-23	DBV	5	250	178.0	9.0	3.23	3.17	1.37	4.0	8.0	Q3
LP2985-33DBVTG4	SOT-23	DBV	5	250	178.0	9.0	3.23	3.17	1.37	4.0	8.0	Q3
LP2985-50DBVR	SOT-23	DBV	5	3000	178.0	9.0	3.23	3.17	1.37	4.0	8.0	Q3
LP2985A-10DBVR	SOT-23	DBV	5	3000	178.0	9.0	3.23	3.17	1.37	4.0	8.0	Q3
LP2985A-10DBVT	SOT-23	DBV	5	250	178.0	9.0	3.3	3.2	1.4	4.0	8.0	Q3
LP2985A-18DBVJ	SOT-23	DBV	5	10000	330.0	8.4	3.17	3.23	1.37	4.0	8.0	Q3

Device	Package Type	Package Drawing	Pins	SPQ	Reel Diameter (mm)	Reel Width W1 (mm)	A0 (mm)	B0 (mm)	K0 (mm)	P1 (mm)	W (mm)	Pin1 Quadrant
LP2985A-18DBVR	SOT-23	DBV	5	3000	178.0	9.0	3.23	3.17	1.37	4.0	8.0	Q3
LP2985A-18DBVRG4	SOT-23	DBV	5	3000	178.0	9.0	3.23	3.17	1.37	4.0	8.0	Q3
LP2985A-25DBVR	SOT-23	DBV	5	3000	178.0	9.0	3.23	3.17	1.37	4.0	8.0	Q3
LP2985A-25DBVT	SOT-23	DBV	5	250	180.0	9.2	3.17	3.23	1.37	4.0	8.0	Q3
LP2985A-28DBVR	SOT-23	DBV	5	3000	178.0	9.0	3.23	3.17	1.37	4.0	8.0	Q3
LP2985A-28DBVR	SOT-23	DBV	5	3000	180.0	9.2	3.17	3.23	1.37	4.0	8.0	Q3
LP2985A-29DBVR	SOT-23	DBV	5	3000	178.0	9.0	3.23	3.17	1.37	4.0	8.0	Q3
LP2985A-30DBVR	SOT-23	DBV	5	3000	178.0	9.0	3.23	3.17	1.37	4.0	8.0	Q3
LP2985A-33DBVR	SOT-23	DBV	5	3000	178.0	9.0	3.3	3.2	1.4	4.0	8.0	Q3
LP2985A-33DBVRG4	SOT-23	DBV	5	3000	178.0	9.0	3.3	3.2	1.4	4.0	8.0	Q3
LP2985A-33DBVT	SOT-23	DBV	5	250	178.0	9.0	3.23	3.17	1.37	4.0	8.0	Q3
LP2985A-33DBVTG4	SOT-23	DBV	5	250	178.0	9.0	3.23	3.17	1.37	4.0	8.0	Q3
LP2985A-50DBVR	SOT-23	DBV	5	3000	178.0	9.0	3.23	3.17	1.37	4.0	8.0	Q3

TAPE AND REEL BOX DIMENSIONS

*All dimensions are nominal

Device	Package Type	Package Drawing	Pins	SPQ	Length (mm)	Width (mm)	Height (mm)
LP2985-10DBVR	SOT-23	DBV	5	3000	180.0	180.0	18.0
LP2985-10DBVT	SOT-23	DBV	5	250	180.0	180.0	18.0
LP2985-18DBVR	SOT-23	DBV	5	3000	180.0	180.0	18.0
LP2985-18DBVRG4	SOT-23	DBV	5	3000	180.0	180.0	18.0

Device	Package Type	Package Drawing	Pins	SPQ	Length (mm)	Width (mm)	Height (mm)
LP2985-18DBVTG4	SOT-23	DBV	5	250	180.0	180.0	18.0
LP2985-25DBVR	SOT-23	DBV	5	3000	180.0	180.0	18.0
LP2985-28DBVR	SOT-23	DBV	5	3000	180.0	180.0	18.0
LP2985-28DBVTG4	SOT-23	DBV	5	250	180.0	180.0	18.0
LP2985-29DBVR	SOT-23	DBV	5	3000	180.0	180.0	18.0
LP2985-30DBVR	SOT-23	DBV	5	3000	180.0	180.0	18.0
LP2985-33DBVR	SOT-23	DBV	5	3000	180.0	180.0	18.0
LP2985-33DBVRG4	SOT-23	DBV	5	3000	180.0	180.0	18.0
LP2985-33DBVT	SOT-23	DBV	5	250	180.0	180.0	18.0
LP2985-33DBVTG4	SOT-23	DBV	5	250	180.0	180.0	18.0
LP2985-50DBVR	SOT-23	DBV	5	3000	180.0	180.0	18.0
LP2985A-10DBVR	SOT-23	DBV	5	3000	180.0	180.0	18.0
LP2985A-10DBVT	SOT-23	DBV	5	250	180.0	180.0	18.0
LP2985A-18DBVJ	SOT-23	DBV	5	10000	358.0	332.0	35.0
LP2985A-18DBVR	SOT-23	DBV	5	3000	180.0	180.0	18.0
LP2985A-18DBVRG4	SOT-23	DBV	5	3000	180.0	180.0	18.0
LP2985A-25DBVR	SOT-23	DBV	5	3000	180.0	180.0	18.0
LP2985A-25DBVT	SOT-23	DBV	5	250	205.0	200.0	33.0
LP2985A-28DBVR	SOT-23	DBV	5	3000	180.0	180.0	18.0
LP2985A-28DBVR	SOT-23	DBV	5	3000	205.0	200.0	33.0
LP2985A-29DBVR	SOT-23	DBV	5	3000	180.0	180.0	18.0
LP2985A-30DBVR	SOT-23	DBV	5	3000	180.0	180.0	18.0
LP2985A-33DBVR	SOT-23	DBV	5	3000	180.0	180.0	18.0
LP2985A-33DBVRG4	SOT-23	DBV	5	3000	180.0	180.0	18.0
LP2985A-33DBVT	SOT-23	DBV	5	250	180.0	180.0	18.0
LP2985A-33DBVTG4	SOT-23	DBV	5	250	180.0	180.0	18.0
LP2985A-50DBVR	SOT-23	DBV	5	3000	180.0	180.0	18.0

DBV0005A



PACKAGE OUTLINE

SOT-23 - 1.45 mm max height

SMALL OUTLINE TRANSISTOR



4214839/D 11/2018

NOTES:

1. All linear dimensions are in millimeters. Any dimensions in parenthesis are for reference only. Dimensioning and tolerancing per ASME Y14.5M.
2. This drawing is subject to change without notice.
3. Reference JEDEC MO-178.
4. Body dimensions do not include mold flash, protrusions, or gate burrs. Mold flash, protrusions, or gate burrs shall not exceed 0.15 mm per side.

EXAMPLE BOARD LAYOUT

DBV0005A

SOT-23 - 1.45 mm max height

SMALL OUTLINE TRANSISTOR



LAND PATTERN EXAMPLE
EXPOSED METAL SHOWN
SCALE:15X



SOLDER MASK DETAILS

4214839/D 11/2018

NOTES: (continued)

- 5. Publication IPC-7351 may have alternate designs.
- 6. Solder mask tolerances between and around signal pads can vary based on board fabrication site.

EXAMPLE STENCIL DESIGN

DBV0005A

SOT-23 - 1.45 mm max height

SMALL OUTLINE TRANSISTOR



SOLDER PASTE EXAMPLE
BASED ON 0.125 mm THICK STENCIL
SCALE:15X

4214839/D 11/2018

NOTES: (continued)

7. Laser cutting apertures with trapezoidal walls and rounded corners may offer better paste release. IPC-7525 may have alternate design recommendations.
8. Board assembly site may have different recommendations for stencil design.

IMPORTANT NOTICE AND DISCLAIMER

TI PROVIDES TECHNICAL AND RELIABILITY DATA (INCLUDING DATASHEETS), DESIGN RESOURCES (INCLUDING REFERENCE DESIGNS), APPLICATION OR OTHER DESIGN ADVICE, WEB TOOLS, SAFETY INFORMATION, AND OTHER RESOURCES "AS IS" AND WITH ALL FAULTS, AND DISCLAIMS ALL WARRANTIES, EXPRESS AND IMPLIED, INCLUDING WITHOUT LIMITATION ANY IMPLIED WARRANTIES OF MERCHANTABILITY, FITNESS FOR A PARTICULAR PURPOSE OR NON-INFRINGEMENT OF THIRD PARTY INTELLECTUAL PROPERTY RIGHTS.

These resources are intended for skilled developers designing with TI products. You are solely responsible for (1) selecting the appropriate TI products for your application, (2) designing, validating and testing your application, and (3) ensuring your application meets applicable standards, and any other safety, security, or other requirements. These resources are subject to change without notice. TI grants you permission to use these resources only for development of an application that uses the TI products described in the resource. Other reproduction and display of these resources is prohibited. No license is granted to any other TI intellectual property right or to any third party intellectual property right. TI disclaims responsibility for, and you will fully indemnify TI and its representatives against, any claims, damages, costs, losses, and liabilities arising out of your use of these resources.

TI's products are provided subject to TI's Terms of Sale (www.ti.com/legal/termsofsale.html) or other applicable terms available either on ti.com or provided in conjunction with such TI products. TI's provision of these resources does not expand or otherwise alter TI's applicable warranties or warranty disclaimers for TI products.

Mailing Address: Texas Instruments, Post Office Box 655303, Dallas, Texas 75265
Copyright © 2019, Texas Instruments Incorporated

Looking for pricing, stock, or lifecycle information?

Click below to explore more details on WIN SOURCE:

 [View LP2985A-50DBVT](#) on WIN SOURCE

 [Texas Instruments](#) Information

Optimize Your Supply Chain with WIN SOURCE Solutions

-  Global Sourcing Solution
-  Obsolete Management
-  Cost Control Management
-  Shortage Management
-  Alternative Solution
-  Excess Inventory Management