



**THE DATASHEET OF
LP38856SX-0.8/NOPB**



LP38856 3-A Fast-Response High-Accuracy LDO Linear Regulator With Enable

1 Features

- Input Voltage: 1.1 V to 5.5 V
- Wide V_{BIAS} Supply Operating Range: 3 V to 5.5 V
- Standard V_{OUT} : 0.8 V and 1.2 V
- Stable with 10- μ F Ceramic Capacitors
- Dropout Voltage of 240 mV (Typical) at 3-A Load Current
- Precision Output Voltage Across All Line and Load Conditions:
 - $\pm 1\%$ for $T_J = 25^\circ\text{C}$
 - $\pm 2\%$ for $0^\circ\text{C} \leq T_J \leq +125^\circ\text{C}$
 - $\pm 3\%$ for $-40^\circ\text{C} \leq T_J \leq +125^\circ\text{C}$
- Overtemperature and Overcurrent Protection
- -40°C to $+125^\circ\text{C}$ Operating Temperature Range

2 Applications

- ASIC Power Supplies In:
 - Desktops, Notebooks, and Graphics Cards, Servers
 - Gaming Set Top Boxes, Printers and Copiers
- Server Core and I/O Supplies
- DSP and FPGA Power Supplies
- SMPS Post-Regulator

3 Description

The LP38856 is a high-current, fast-response regulator which can maintain output voltage regulation with an extremely low input-to-output voltage drop. Fabricated on a CMOS process, the device operates from two input voltages: V_{BIAS} provides power for the internal bias and control circuits, as well as drive for the gate of the N-MOS power transistor, while V_{IN} supplies power to the load. The use of an external bias rail allows the part to operate from ultra-low V_{IN} voltages. Unlike bipolar regulators, the CMOS architecture consumes extremely low quiescent current at any output load current. The use of an N-MOS power transistor results in wide bandwidth, yet minimum external capacitance is required to maintain loop stability.

The fast transient response of this device makes it suitable for use in powering DSP, microcontroller core voltages, and switch mode power supply post regulators. The LP38856 is available in 5-pin TO-220 and DDPAK/TO-263 packages.

- Dropout Voltage: 240 mV (typical) at 3-A load current.
- Low Ground Pin Current: 10 mA (typical) at 3-A load current.
- Shutdown Current: 1 μ A (typical) $I_{IN(GND)}$ when EN pin is low.
- Precision Output Voltage: $\pm 1\%$ for $T_J = 25^\circ\text{C}$ and $\pm 2\%$ for $0^\circ\text{C} \leq T_J \leq +125^\circ\text{C}$, across all line and load conditions.

Device Information⁽¹⁾

PART NUMBER	PACKAGE	BODY SIZE (NOM)
LP38856	DDPAK/TO-263 (5)	10.16 mm x 8.42 mm
	TO-220 (5)	14.986 mm x 10.16 mm

(1) For all available packages, see the orderable addendum at the end of the data sheet.

Typical Application Circuit

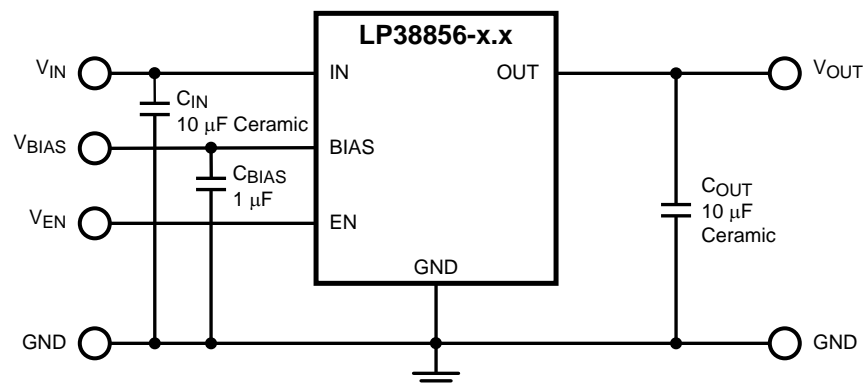

Table of Contents

1 Features	1	7.3 Feature Description.....	10
2 Applications	1	7.4 Device Functional Modes.....	11
3 Description	1	8 Application and Implementation	12
4 Revision History	2	8.1 Application Information.....	12
5 Pin Configuration and Functions	3	8.2 Typical Application	12
6 Specifications	3	9 Power Supply Recommendations	14
6.1 Absolute Maximum Ratings	3	10 Layout	15
6.2 ESD Ratings	3	10.1 Layout Guidelines	15
6.3 Recommended Operating Conditions.....	4	10.2 Layout Example	15
6.4 Thermal Information	4	11 Device and Documentation Support	16
6.5 Electrical Characteristics.....	4	11.1 Community Resources.....	16
6.6 Typical Characteristics.....	6	11.2 Trademarks	16
7 Detailed Description	10	11.3 Electrostatic Discharge Caution.....	16
7.1 Overview	10	11.4 Glossary	16
7.2 Functional Block Diagram	10	12 Mechanical, Packaging, and Orderable Information	17

4 Revision History

NOTE: Page numbers for previous revisions may differ from page numbers in the current version.

Changes from Revision E (April 2013) to Revision F

Page

- Added *Device Information* and *Pin Configuration and Functions* sections, *ESD Ratings* table, *Feature Description*, *Device Functional Modes*, *Application and Implementation*, *Power Supply Recommendations*, *Layout*, *Device and Documentation Support*, and *Mechanical, Packaging, and Orderable Information* sections; remove lead temp from Abs Max (in POA), remove obsolete heatsinking content..... **1**

Changes from Revision D (April 2013) to Revision E

Page

- Changed layout of National data sheet to TI format

5 Pin Configuration and Functions



Pin Functions

PIN		TYPE	DESCRIPTION
NO.	NAME		
1	EN	I	The device enable pin.
2	IN	I	The unregulated input voltage pin
3	GND	—	Ground
4	OUT	O	The regulated output voltage pin
5	BIAS	I	The supply for the internal control and reference circuitry
TAB	TAB	—	The TAB is a thermal connection that is physically attached to the backside of the die, and is used as a thermal heat-sink connection. See the Application and Implementation section for details

6 Specifications

6.1 Absolute Maximum Ratings

over operating free-air temperature range (unless otherwise noted)⁽¹⁾⁽²⁾

		MIN	MAX	UNIT
	Power dissipation ⁽³⁾	Internally limited		
V _{IN}	Supply voltage (survival)	-0.3	6	V
V _{BIAS}	Supply voltage (survival)	-0.3	6	V
V _{EN}	Voltage (survival)	-0.3	6	V
V _{OUT}	Voltage (survival)	-0.3	6	V
I _{OUT}	Current (survival)	Internally Limited		
T _J	Junction temperature	-40	150	°C
T _{stg}	Storage temperature	-65	150	°C

- (1) Stresses beyond those listed under *Absolute Maximum Ratings* may cause permanent damage to the device. These are stress ratings only, which do not imply functional operation of the device at these or any other conditions beyond those indicated under *Recommended Operating Conditions*. Exposure to absolute-maximum-rated conditions for extended periods may affect device reliability.
- (2) If Military/Aerospace specified devices are required, contact the TI Sales Office/ Distributors for availability and specifications.
- (3) Device power dissipation must be de-rated based on device power dissipation (T_D), ambient temperature (T_A), and package junction to ambient thermal resistance (R_{θJA}). Additional heat-sinking may be required to ensure that the device junction temperature (T_J) does not exceed the maximum operating rating. See [Application and Implementation](#) for details.

6.2 ESD Ratings

		VALUE	UNIT
V _(ESD)	Electrostatic discharge	Human-body model (HBM), per ANSI/ESDA/JEDEC JS-001 ⁽¹⁾	±2000 V

- (1) JEDEC document JEP155 states that 500-V HBM allows safe manufacturing with a standard ESD control process.

6.3 Recommended Operating Conditions

over operating free-air temperature range (unless otherwise noted)⁽¹⁾

		MIN	NOM	MAX	UNIT
V _{IN}	Supply voltage	(V _{OUT} + V _{DO})		V _{BIAS}	
V _{BIAS}	Supply voltage	3		5.5	V
V _{EN}	Enable input voltage	0.0		V _{BIAS}	
I _{OUT}	Output current	0		3	mA/A
	Junction temperature range ⁽²⁾	-40		125	°C

- (1) Absolute maximum ratings indicate limits beyond which damage to the component may occur. Operating ratings indicate conditions for which the device is intended to be functional, but do not ensure specific performance limits (see [Electrical Characteristics](#)). Specifications do not apply when operating the device outside of its rated operating conditions.
- (2) Device power dissipation must be de-rated based on device power dissipation (T_D), ambient temperature (T_A), and package junction to ambient thermal resistance (R_{θJA}). Additional heat-sinking may be required to ensure that the device junction temperature (T_J) does not exceed the maximum operating rating. See [Application and Implementation](#) for details.

6.4 Thermal Information

THERMAL METRIC ⁽¹⁾	LP38856		UNIT	
	KTT (DDPAK/TO-263)	NDH (TO-220)		
	5 PINS			
R _{θJA}	Junction-to-ambient thermal resistance	41.8	32.0	°C/W
R _{θJC(top)}	Junction-to-case (top) thermal resistance	45.0	43.8	°C/W
R _{θJB}	Junction-to-board thermal resistance	24.8	18.6	°C/W
ψ _{JT}	Junction-to-top characterization parameter	13.1	8.8	°C/W
ψ _{JB}	Junction-to-board characterization parameter	23.8	18.0	°C/W
R _{θJC(bot)}	Junction-to-case (bottom) thermal resistance	2.4	1.2	°C/W

- (1) For more information about traditional and new thermal metrics, see the *Semiconductor and IC Package Thermal Metrics* application report, [SPRA953](#).

6.5 Electrical Characteristics

Unless otherwise specified: V_{IN} = V_{OUT(NOM)} + 1 V, V_{BIAS} = 3 V, I_{OUT} = 10 mA, C_{IN} = C_{OUT} = 10 μF, C_{BIAS} = 1 μF, V_{EN} = V_{BIAS}. Limits apply for T_J = 25°C only unless otherwise specified. Minimum and Maximum limits are specified through test, design, or statistical correlation. Typical values represent the most likely parametric norm at T_J = 25°C, and are provided for reference purposes only.

PARAMETER	TEST CONDITIONS	MIN	TYP	MAX	UNIT
V _{OUT}	Output Voltage Tolerance	V _{OUT(NOM)} + 1 V ≤ V _{IN} ≤ V _{BIAS} 3 V ≤ V _{BIAS} ≤ 5.5 V, 10 mA ≤ I _{OUT} ≤ 3 A	-1%	0%	+1%
		V _{OUT(NOM)} + 1 V ≤ V _{IN} ≤ V _{BIAS} 3 V ≤ V _{BIAS} ≤ 5.5 V, 10 mA ≤ I _{OUT} ≤ 3 A T _J = -40°C to 125°C	-3%		3%
		V _{OUT(NOM)} + 1 V ≤ V _{IN} ≤ V _{BIAS} 3 V ≤ V _{BIAS} ≤ 5.5 V, 10 mA ≤ I _{OUT} ≤ 3.0 A 0°C ≤ T _J ≤ 125°C	-2%	0%	2%
ΔV _{OUT} /ΔV _{IN}	Line regulation, V _{IN} ⁽¹⁾		0.04		%/V
ΔV _{OUT} /ΔV _{BIAS}	Line regulation, V _{BIAS} ⁽¹⁾		0.10		%/V
ΔV _{OUT} /ΔI _{OUT}	Output voltage load regulation ⁽²⁾		0.2		%/A
V _{DO}	Dropout voltage, V _{IN} - V _{OUT} ⁽³⁾	I _{OUT} = 3 A	240	300	mV
		I _{OUT} = 3 A, T _J = -40°C to 125°C		450	

- (1) Output voltage line regulation is defined as the change in output voltage from nominal value resulting from a change in input voltage.
- (2) Output voltage load regulation is defined as the change in output voltage from nominal value as the load current increases from no load to full load.
- (3) Dropout voltage is defined as the input to output voltage differential (V_{IN} - V_{OUT}) where the input voltage is low enough to cause the output voltage to drop no more than 2% from the nominal value

Electrical Characteristics (continued)

Unless otherwise specified: $V_{IN} = V_{OUT(NOM)} + 1\text{ V}$, $V_{BIAS} = 3\text{ V}$, $I_{OUT} = 10\text{ mA}$, $C_{IN} = C_{OUT} = 10\text{ }\mu\text{F}$, $C_{BIAS} = 1\text{ }\mu\text{F}$, $V_{EN} = V_{BIAS}$. Limits apply for $T_J = 25^\circ\text{C}$ only unless otherwise specified. Minimum and Maximum limits are specified through test, design, or statistical correlation. Typical values represent the most likely parametric norm at $T_J = 25^\circ\text{C}$, and are provided for reference purposes only.

PARAMETER		TEST CONDITIONS	MIN	TYP	MAX	UNIT
$I_{GND(IN)}$	Ground pin current drawn from V_{IN} supply	LP38856-0.8: $10\text{ mA} \leq I_{OUT} \leq 3\text{ A}$		7	8.5	mA
		LP38856-0.8: $10\text{ mA} \leq I_{OUT} \leq 3\text{ A}$ $T_J = -40^\circ\text{C}$ to 125°C			9	
		LP38856-1.2: $10\text{ mA} \leq I_{OUT} \leq 3\text{ A}$		11	12	
		LP38856-1.2: $10\text{ mA} \leq I_{OUT} \leq 3\text{ A}$ $T_J = -40^\circ\text{C}$ to 125°C			15	
	μA	$V_{EN} \leq 0.5\text{ V}$			1	10
		$V_{EN} \leq 0.5\text{ V}$, $T_J = -40^\circ\text{C}$ to 125°C				300
$I_{GND(BIAS)}$	Ground pin current drawn from V_{BIAS} supply	$10\text{ mA} \leq I_{OUT} \leq 3\text{ A}$		3	3.8	mA
		$10\text{ mA} \leq I_{OUT} \leq 3\text{ A}$ $T_J = -40^\circ\text{C}$ to 125°C			4.5	
	μA	$V_{EN} \leq 0.5\text{ V}$			100	170
		$V_{EN} \leq 0.5\text{ V}$, $T_J = -40^\circ\text{C}$ to 125°C				200
UVLO	Undervoltage lock-out threshold	V_{BIAS} rising until device is functional	2.20	2.45	2.70	V
		V_{BIAS} rising until device is functional $T_J = -40^\circ\text{C}$ to 125°C	2		2.9	
UVLO _(HYS)	Undervoltage lock-out hysteresis	V_{BIAS} falling from UVLO threshold until device is non-functional	60	150	300	mV
			50		350	
I_{SC}	Output short-circuit current	$V_{IN} = V_{OUT(NOM)} + 1\text{ V}$, $V_{BIAS} = 3\text{ V}$, $V_{OUT} = 0\text{ V}$		6.2		A
ENABLE PIN						
I_{EN}	ENABLE pin current	$V_{EN} = V_{BIAS}$		0.01		μA
		$V_{EN} = 0\text{ V}$, $V_{BIAS} = 5.5\text{ V}$	-19	-30	-40	
		$V_{EN} = 0\text{ V}$, $V_{BIAS} = 5.5\text{ V}$ $T_J = -40^\circ\text{C}$ to 125°C	-13		-51	
$V_{EN(ON)}$	Enable voltage threshold	V_{EN} rising until Output = ON	1	1.25	1.50	V
		V_{EN} rising until Output = ON $T_J = -40^\circ\text{C}$ to 125°C	0.9		1.55	
$V_{EN(HYS)}$	Enable voltage hysteresis	V_{EN} falling from $V_{EN(ON)}$ until Output = OFF	50	100	150	mV
		V_{EN} falling from $V_{EN(ON)}$ until Output = OFF $T_J = -40^\circ\text{C}$ to 125°C	30		200	
t_{OFF}	Turn-OFF delay time	$R_{LOAD} \times C_{OUT} \ll t_{OFF}$		20		μs
t_{ON}	Turn-ON delay time	$R_{LOAD} \times C_{OUT} \ll t_{ON}$		15		
AC PARAMETERS						
PSRR (V_{IN})	Ripple rejection for V_{IN} input voltage	$V_{IN} = V_{OUT} + 1\text{ V}$, $f = 120\text{ Hz}$		80		dB
		$V_{IN} = V_{OUT} + 1\text{ V}$, $f = 1\text{ kHz}$		65		
PSRR (V_{BIAS})	Ripple rejection for V_{BIAS} voltage	$V_{BIAS} = V_{OUT} + 3\text{ V}$, $f = 120\text{ Hz}$		58		dB
		$V_{BIAS} = V_{OUT} + 3\text{ V}$, $f = 1\text{ kHz}$		58		
e_n	Output noise density	$f = 120\text{ Hz}$		1		$\mu\text{V}/\sqrt{\text{Hz}}$
	Output noise voltage	BW = 10 Hz – 100 kHz		150		$\mu\text{V}_{(RMS)}$
		BW = 300 Hz – 300 kHz			90	
THERMAL PARAMETERS						
T_{SD}	Thermal shutdown junction temperature			160		$^\circ\text{C}$
$T_{SD(HYS)}$	Thermal shutdown hysteresis			10		

6.6 Typical Characteristics

Unless otherwise specified: $T_J = 25^\circ\text{C}$, $V_{IN} = V_{OUT(NOM)} + 1\text{V}$, $V_{BIAS} = 3\text{V}$, $I_{OUT} = 10\text{mA}$, $C_{IN} = C_{OUT} = 10\text{-}\mu\text{F}$ ceramic, $C_{BIAS} = 1\text{-}\mu\text{F}$ ceramic, $V_{EN} = V_{BIAS}$.

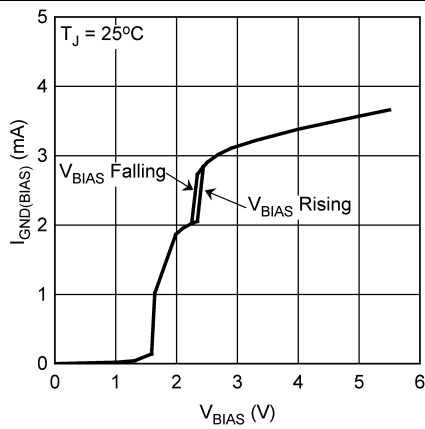

Figure 1. V_{BIAS} Ground Pin Current ($I_{GND(BIAS)}$) vs V_{BIAS}

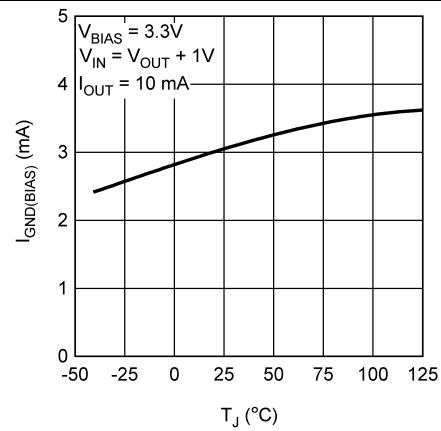

Figure 2. V_{BIAS} Ground Pin Current ($I_{GND(BIAS)}$) vs Temperature

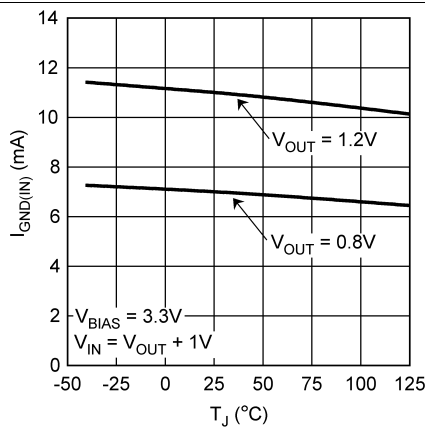

Figure 3. V_{IN} Ground Pin Current ($I_{GND(IN)}$) vs Temperature

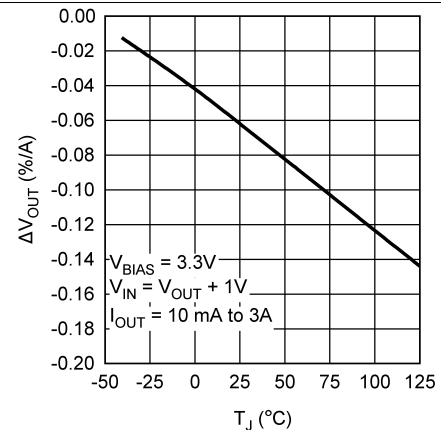

Figure 4. Load Regulation vs Temperature

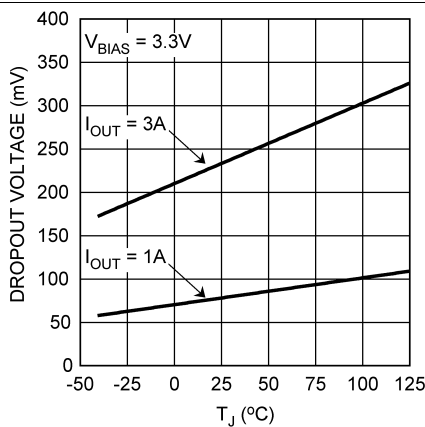

Figure 5. Dropout Voltage (V_{DO}) vs Temperature

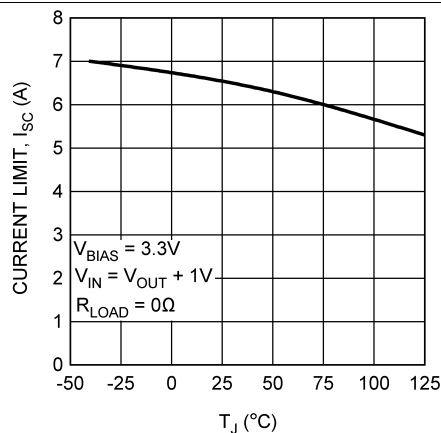

Figure 6. Output Current Limit (I_{SC}) vs Temperature

Typical Characteristics (continued)

Unless otherwise specified: $T_J = 25^\circ\text{C}$, $V_{IN} = V_{OUT(NOM)} + 1\text{ V}$, $V_{BIAS} = 3\text{ V}$, $I_{OUT} = 10\text{ mA}$, $C_{IN} = C_{OUT} = 10\text{-}\mu\text{F}$ ceramic, $C_{BIAS} = 1\text{-}\mu\text{F}$ ceramic, $V_{EN} = V_{BIAS}$.

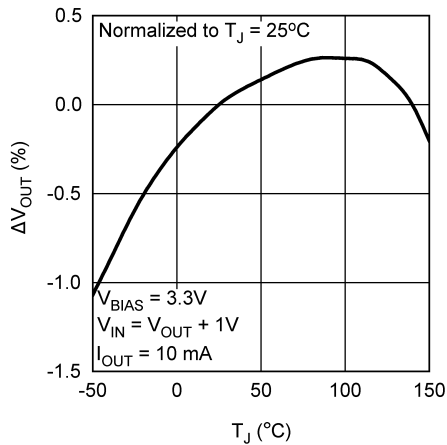

Figure 7. V_{OUT} vs Temperature

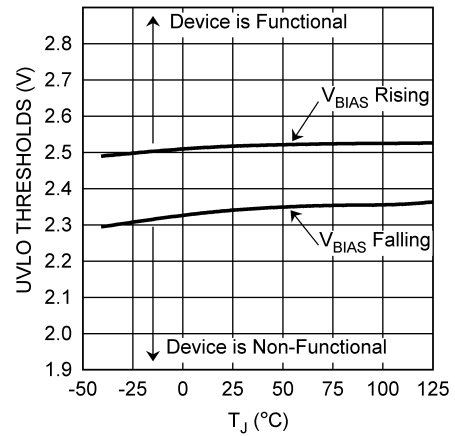

Figure 8. UVLO Thresholds vs Temperature

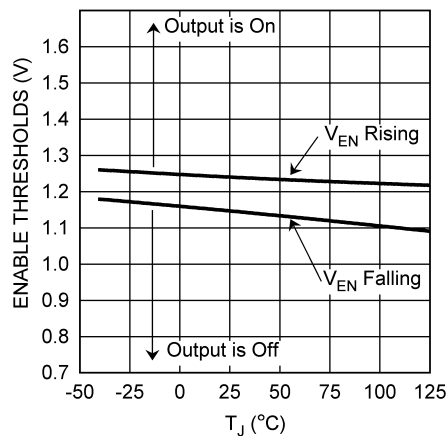

Figure 9. Enable Thresholds (V_{EN}) vs Temperature

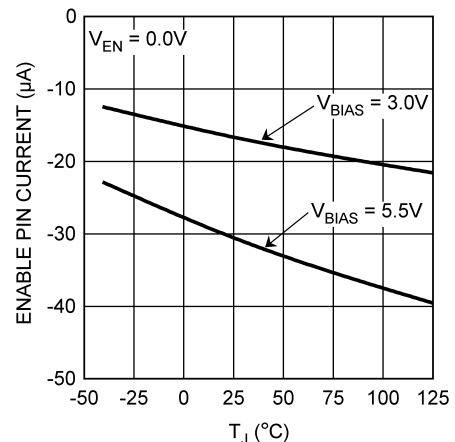

Figure 10. Enable Pull-Down Current (I_{EN}) vs Temperature

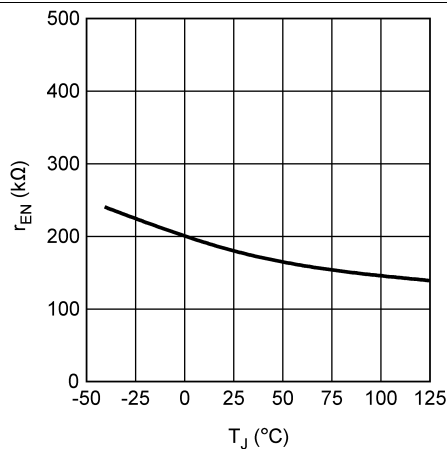

Figure 11. Enable Pull-Up Resistor (R_{EN}) vs Temperature

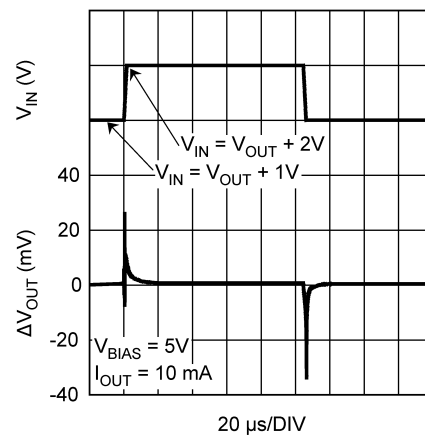

Figure 12. V_{IN} Line Transient Response

Typical Characteristics (continued)

Unless otherwise specified: $T_J = 25^\circ\text{C}$, $V_{IN} = V_{OUT(NOM)} + 1\text{ V}$, $V_{BIAS} = 3\text{ V}$, $I_{OUT} = 10\text{ mA}$, $C_{IN} = C_{OUT} = 10\text{-}\mu\text{F}$ ceramic, $C_{BIAS} = 1\text{-}\mu\text{F}$ ceramic, $V_{EN} = V_{BIAS}$.

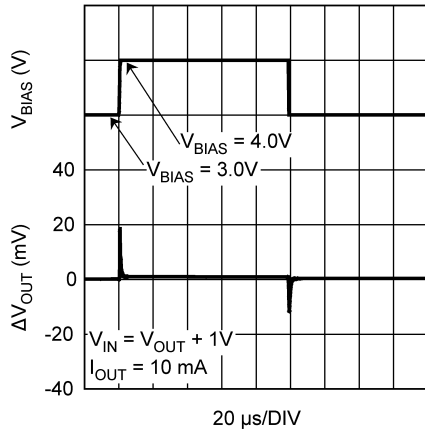

Figure 13. V_{BIAS} Line Transient Response

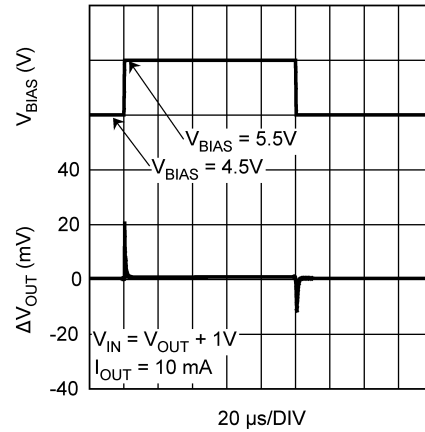

Figure 14. V_{BIAS} Line Transient Response

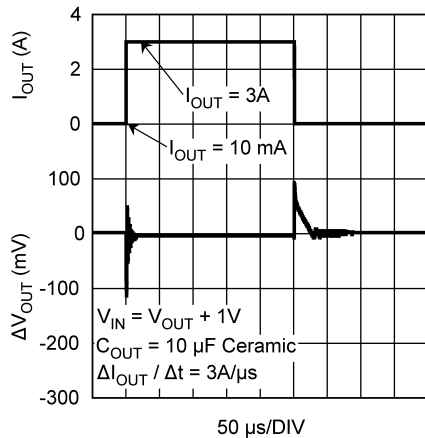
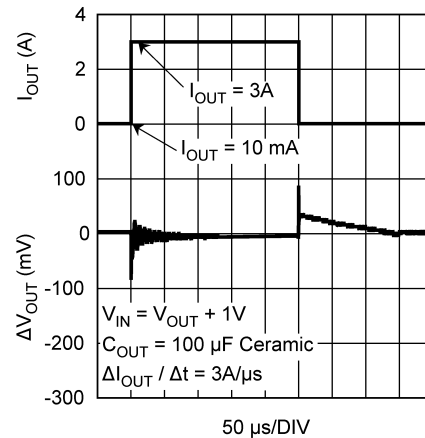
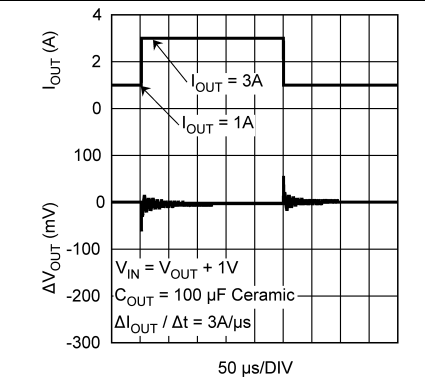

Figure 15. Load Transient Response, $C_{OUT} = 10\text{-}\mu\text{F}$ Ceramic



$C_{OUT} = 100\text{-}\mu\text{F}$ Ceramic

Figure 16. Load Transient Response



$C_{OUT} = 100\text{-}\mu\text{F}$ Ceramic

Figure 17. Load Transient Response

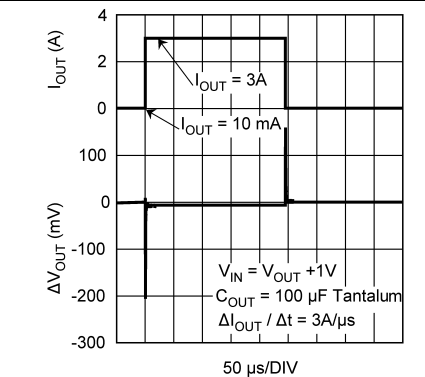

$C_{OUT} = 100\text{-}\mu\text{F}$ Tantalum

Figure 18. Load Transient Response

Typical Characteristics (continued)

Unless otherwise specified: $T_J = 25^\circ\text{C}$, $V_{IN} = V_{OUT(NOM)} + 1\text{ V}$, $V_{BIAS} = 3\text{ V}$, $I_{OUT} = 10\text{ mA}$, $C_{IN} = C_{OUT} = 10\text{-}\mu\text{F}$ ceramic, $C_{BIAS} = 1\text{-}\mu\text{F}$ ceramic, $V_{EN} = V_{BIAS}$.

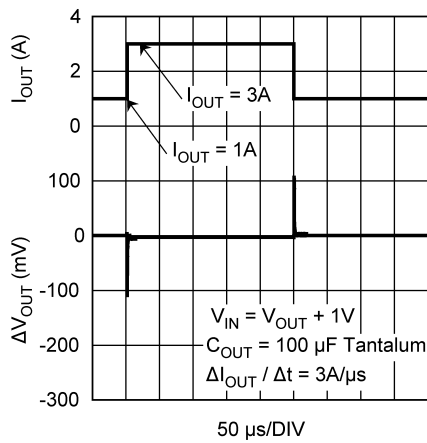

$C_{OUT} = 100\text{-}\mu\text{F}$ Tantalum

Figure 19. Load Transient Response

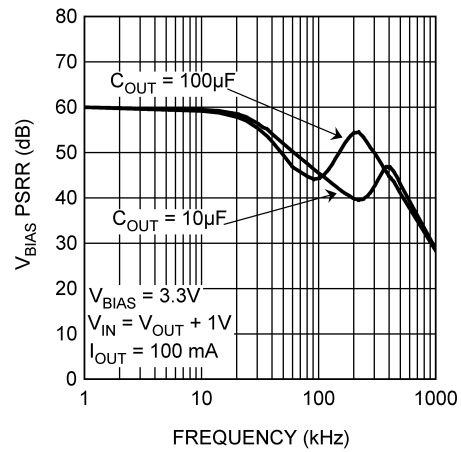

Figure 20. V_{BIAS} PSRR

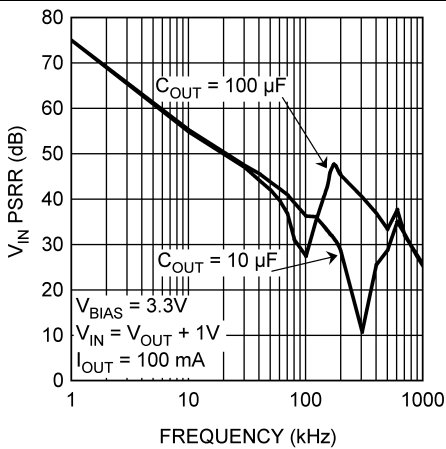

Figure 21. V_{IN} PSRR

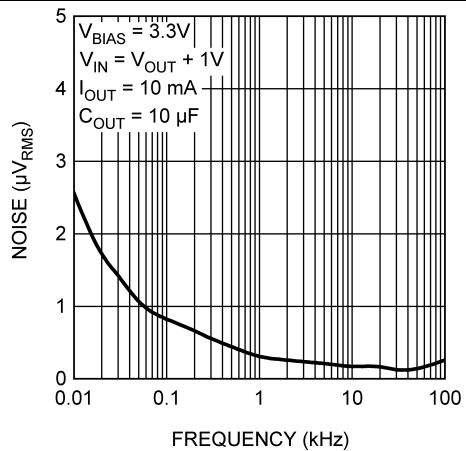

Figure 22. Output Noise

7 Detailed Description

7.1 Overview

The LP38556 is a fast-response, high-current, low-dropout regulator, available in output voltages 0.8 V and 1.2 V. This device is capable of delivering 3-A continuous load current. Standard regulator features, such as overcurrent and overtemperature protection, are also included.

The LP38556 contains several features:

- Low dropout voltage, typical 240 mV at 3-A load.
- Low GND pin current, typical 10 mA at 3-A load.
- A shutdown feature is available, allowing the regulator to consume only 1 μ A when EN pin is low.

7.2 Functional Block Diagram

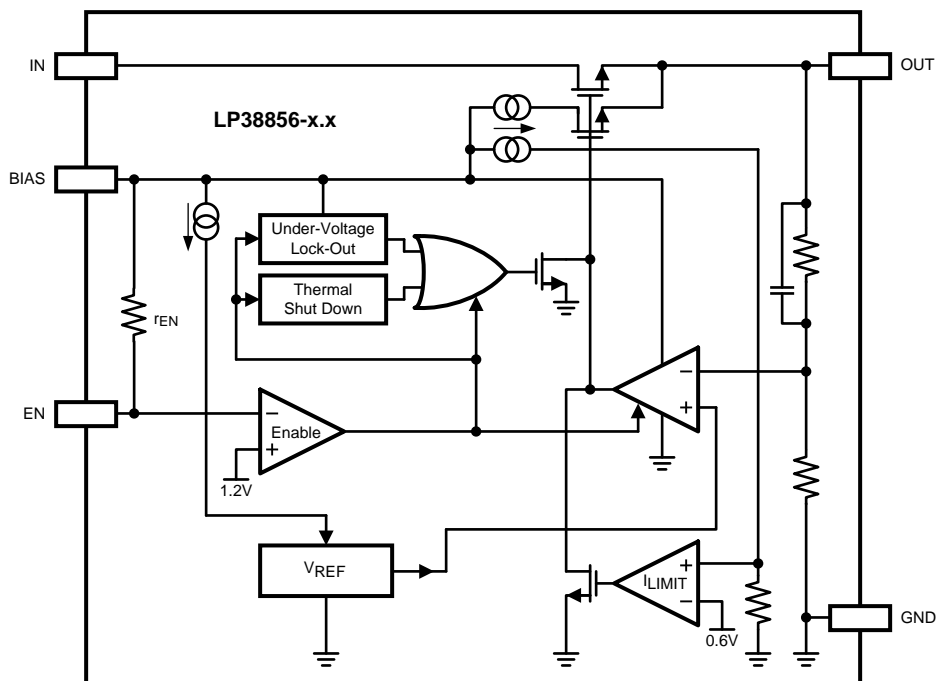

7.3 Feature Description

7.3.1 Enable Operation

The enable pin (EN) provides a mechanism to enable, or disable, the regulator output stage. The EN pin has an internal pullup, through a typical 180-k Ω resistor, to V_{BIAS} .

If the EN pin is actively driven, pulling the EN pin above the V_{EN} threshold of 1.25 V (typical) will turn the regulator output on, while pulling the EN pin below the V_{EN} threshold will turn the regulator output off. There is approximately 100 mV of hysteresis built into the enable threshold provide noise immunity.

If the enable function is not needed, the EN pin must be left open, or connected directly to V_{BIAS} . If the EN pin is left open, stray capacitance on this pin must be minimized, otherwise the output turnon will be delayed while the stray capacitance is charged through the internal resistance (r_{EN}).

7.3.2 Input Voltage

The input voltage (V_{IN}) is the high current external voltage rail that will be regulated down to a lower voltage, which is applied to the load. The input voltage must be at least $V_{OUT} + V_{DO}$, and no higher than whatever value is used for V_{BIAS} .

Feature Description (continued)

7.3.3 Bias Voltage

The bias voltage (V_{BIAS}) is a low current external voltage rail required to bias the control circuitry and provide gate drive for the N-FET pass transistor. The bias voltage must be in the range of 3 V to 5.5 V to ensure proper operation of the device.

7.3.4 Undervoltage Lockout

The bias voltage is monitored by a circuit which prevents the device from functioning when the bias voltage is below the undervoltage lock-out (UVLO) threshold of approximately 2.45 V.

As the bias voltage rises above the UVLO threshold the device control circuitry become active. There is approximately 150 mV of hysteresis built into the UVLO threshold to provide noise immunity.

When the bias voltage is between the UVLO threshold and the minimum operating rating value of 3 V the device will be functional, but the operating parameters will not be within the specified limits.

7.3.5 Supply Sequencing

There is no requirement for the order that V_{IN} or V_{BIAS} are applied or removed. However, the output voltage cannot be specified until both V_{IN} and V_{BIAS} are within the range of specified operating values.

If used in a dual-supply system where the regulator load is returned to a negative supply, the output pin must be diode clamped to ground. A Schottky diode is recommend for this diode clamp.

7.3.6 Reverse Voltage

A reverse voltage condition will exist when the voltage at the OUT pin is higher than the voltage at the input pin. Typically this will happen when V_{IN} is abruptly taken low and C_{OUT} continues to hold a sufficient charge such that the input to output voltage becomes reversed.

The NMOS pass element, by design, contains no body diode. This means that, as long as the gate of the pass element is not driven, there will not be any reverse current flow through the pass element during a reverse voltage event. The gate of the pass element is not driven when V_{BIAS} is below the UVLO threshold.

When V_{BIAS} is above the UVLO threshold the control circuitry is active and will attempt to regulate the output voltage. Because the input voltage is less than the output voltage, the control circuit will drive the gate of the pass element to the full V_{BIAS} potential when the output voltage begins to fall. In this condition, reverse current will flow from the OUT pin to the IN pin, limited only by the $R_{DS(ON)}$ of the pass element and the output-to-input voltage differential. This condition is outside the specified operating range and must be avoided.

7.4 Device Functional Modes

7.4.1 Operation with $3\text{ V} \leq V_{BIAS} \leq 5.5\text{ V}$, $V_{OUT(TARGET)} + 0.3\text{ V} \leq V_{IN} \leq V_{BIAS}$

The device operates if the bias voltage is equal to, or exceeds, 3 V; input voltage is equal to, or exceeds, $V_{OUT(TARGET)} + 0.3\text{ V}$. At bias voltages below the minimum V_{BIAS} requirement, the device does not operate correctly, and output voltage may not reach target value.

7.4.2 Operation with V_{EN} Control

If the voltage on the EN pin is less than 1 V, the device is disabled. Raising V_{EN} above 1.5 V initiates the start-up sequence of the device.

8 Application and Implementation

NOTE

Information in the following applications sections is not part of the TI component specification, and TI does not warrant its accuracy or completeness. TI's customers are responsible for determining suitability of components for their purposes. Customers should validate and test their design implementation to confirm system functionality.

8.1 Application Information

The LP38856 can provide 3-A output current with 240-mV dropout voltage (typical). The bias voltage must be in the range of 3 V to 5.5 V to ensure proper operation of the device. The input voltage must be at least $V_{OUT} + V_{DO}$, and no higher than whatever value is used for V_{BIAS} . Minimal input and output capacitor are 10 μ F. The capacitor on the bias pin must be at least 1 μ F.

8.2 Typical Application

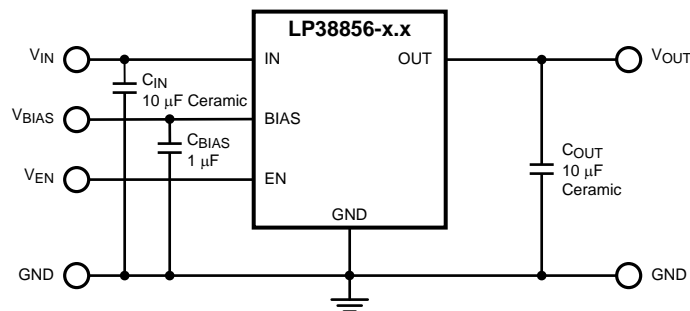

Figure 23. LP38856 Typical Application

8.2.1 Design Requirements

For LP38856 typical applications, use the parameters listed in [Table 1](#) as the input parameters.

Table 1. Design Parameters

DESIGN PARAMETERS	VALUE
Bias voltage	3 V to 5.5 V
Input voltage	$V_{OUT} + 0.3$ V to V_{BIAS}
Output voltage	0.8 V or 1.2 V
Output current	3 A (maximum)
Bias capacitor	1 μ F (minimum)
Input capacitor	10 μ F (minimum)
Output capacitor	10 μ F (minimum)

8.2.2 Detailed Design Procedure

8.2.2.1 External Capacitors

To assure regulator stability, capacitors are required on the IN, OUT, and BIAS pins as shown in [Figure 23](#).

8.2.2.1.1 Output Capacitor

A minimum output capacitance of 10 μ F, ceramic, is required for stability. The amount of output capacitance can be increased without limit. The output capacitor must be located less than 1 cm from the output pin of the device and returned to the device ground pin with a clean analog ground.

Only high quality ceramic types such as X5R or X7R should be used, as the Z5U and Y5F types do not provide sufficient capacitance over temperature.

Tantalum capacitors will also provide stable operation across the entire operating temperature range. However, the effects of ESR may provide variations in the output voltage during fast load transients. Using the minimum recommended 10 μF ceramic capacitor at the output will allow unlimited capacitance, tantalum and/or aluminum, to be added in parallel.

8.2.2.1.2 Input Capacitor

The input capacitor must be at least 10 μF , but can be increased without limit. Its purpose is to provide a low source impedance for the regulator input. A ceramic capacitor, X5R or X7R, is recommended.

Tantalum capacitors may also be used at the input pin. There is no specific ESR limitation on the input capacitor (the lower, the better).

Aluminum electrolytic capacitors can be used, but are not recommended as their ESR increases very quickly at cold temperatures. They are not recommended for any application where the ambient temperature falls below 0°C.

8.2.2.1.3 Bias Capacitor

The capacitor on the bias pin must be at least 1 μF . It can be any good quality capacitor (ceramic is recommended).

8.2.2.2 Power Dissipation and Heatsinking

A heat-sink may be required depending on the maximum power dissipation and maximum ambient temperature of the application. Under all possible conditions, the junction temperature must be within the range specified under operating conditions.

The total power dissipation of the device is the sum of three different points of dissipation in the device.

The first part is the power that is dissipated in the NMOS pass element, and can be determined with the formula:

$$P_{D(\text{PASS})} = (V_{\text{IN}} - V_{\text{OUT}}) \times I_{\text{OUT}} \quad (1)$$

The second part is the power that is dissipated in the bias and control circuitry, and can be determined with the formula:

$$P_{D(\text{BIAS})} = V_{\text{BIAS}} \times I_{\text{GND}(\text{BIAS})}$$

where

- $I_{\text{GND}(\text{BIAS})}$ is the portion of the operating ground current of the device that is related to V_{BIAS} . (2)

The third part is the power that is dissipated in portions of the output stage circuitry, and can be determined with the formula:

$$P_{D(\text{IN})} = V_{\text{IN}} \times I_{\text{GND}(\text{IN})}$$

where

- $I_{\text{GND}(\text{IN})}$ is the portion of the operating ground current of the device that is related to V_{IN} . (3)

The total power dissipation is then:

$$P_{\text{D}} = P_{D(\text{PASS})} + P_{D(\text{BIAS})} + P_{D(\text{IN})} \quad (4)$$

The maximum allowable junction temperature rise (ΔT_{J}) depends on the maximum anticipated ambient temperature ($T_{\text{A}(\text{MAX})}$) for the application, and the maximum allowable operating junction temperature ($T_{\text{J}(\text{MAX})}$):

$$\Delta T_{\text{J}} = T_{\text{J}(\text{MAX})} - T_{\text{A}(\text{MAX})} \quad (5)$$

The maximum allowable value for junction to ambient thermal resistance, $R_{\theta\text{JA}}$, can be calculated using the formula:

$$R_{\theta\text{JA}} \leq \Delta T_{\text{J}} / P_{\text{D}} \quad (6)$$

The LP38856 is available in TO-220 and DDPACK/TO-263 packages. The thermal resistance in the application depends on amount of copper area or heat-sink, and on air flow. If the maximum allowable value of $R_{\theta\text{JA}}$ calculated above is $\geq 32^\circ\text{C}/\text{W}$ for TO-220 package and $\geq 41^\circ\text{C}/\text{W}$ for DDPACK/TO-263 package no heat-sink is needed because the package alone can dissipate enough heat to satisfy these requirements. If the value needed for allowable $R_{\theta\text{JA}}$ falls below these limits, a heat-sink is required.

8.2.3 Application Curves

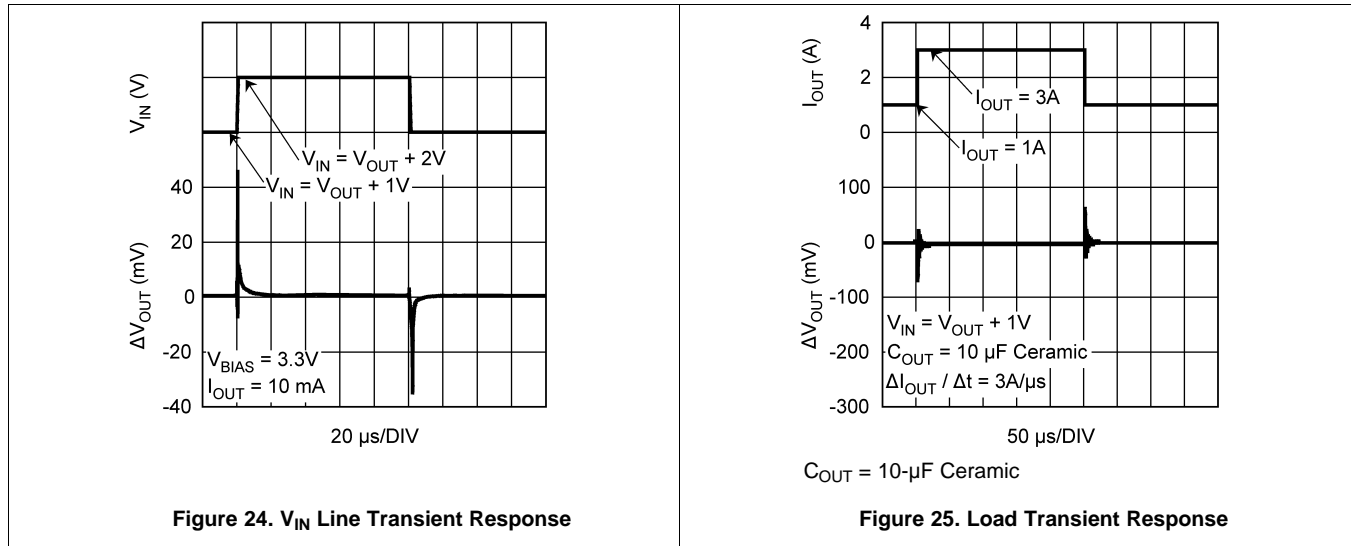

9 Power Supply Recommendations

The LP38856 device is designed to operate from an bias voltage supply range between 3 V and 5.5 V, and the input voltage in the range between $V_{OUT} + 0.3$ V and V_{BIAS} . Input supply must be well regulated. An input capacitor of at least 10 μ F is required.

10 Layout

10.1 Layout Guidelines

Good layout practices will minimize voltage error and prevent instability which can result from ground loops. The input and output capacitors must be directly connected to the device pins with short traces that have no other current flowing in them (Kelvin connect).

The best way to do this is to place the capacitors very near the device and make connections directly to the device pins via short traces on the top layer of the PCB. The regulator's ground pin must be connected through vias to the internal or backside ground plane so that the regulator has a single point ground.

The external resistors which set the output voltage must also be located very near the device with all connections directly tied via short traces to the pins of the device (Kelvin connect). Do not connect the resistive divider to the load point or DC error will be induced.

10.2 Layout Example

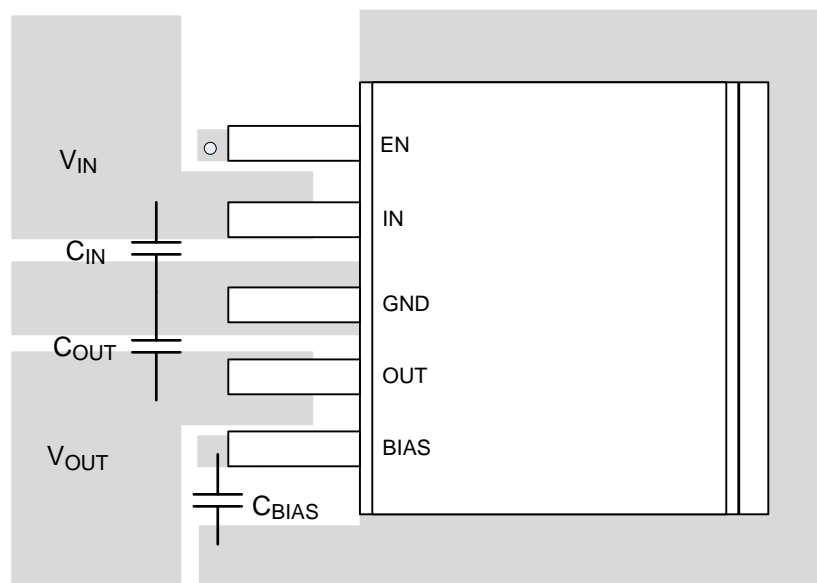

Figure 26. LP38856 Layout Example

11 Device and Documentation Support

11.1 Community Resources

The following links connect to TI community resources. Linked contents are provided "AS IS" by the respective contributors. They do not constitute TI specifications and do not necessarily reflect TI's views; see TI's [Terms of Use](#).

TI E2E™ Online Community *TI's Engineer-to-Engineer (E2E) Community*. Created to foster collaboration among engineers. At e2e.ti.com, you can ask questions, share knowledge, explore ideas and help solve problems with fellow engineers.

Design Support *TI's Design Support* Quickly find helpful E2E forums along with design support tools and contact information for technical support.

11.2 Trademarks

E2E is a trademark of Texas Instruments.
All other trademarks are the property of their respective owners.

11.3 Electrostatic Discharge Caution



These devices have limited built-in ESD protection. The leads should be shorted together or the device placed in conductive foam during storage or handling to prevent electrostatic damage to the MOS gates.

11.4 Glossary

[SLYZ022](#) — *TI Glossary*.

This glossary lists and explains terms, acronyms, and definitions.

12 Mechanical, Packaging, and Orderable Information

The following pages include mechanical, packaging, and orderable information. This information is the most current data available for the designated devices. This data is subject to change without notice and revision of this document. For browser-based versions of this data sheet, refer to the left-hand navigation.

PACKAGING INFORMATION

Orderable Device	Status (1)	Package Type	Package Drawing	Pins	Package Qty	Eco Plan (2)	Lead/Ball Finish (6)	MSL Peak Temp (3)	Op Temp (°C)	Device Marking (4/5)	Samples
LP38856S-1.2/NOPB	ACTIVE	DDPAK/ TO-263	KTT	5	45	Pb-Free (RoHS Exempt)	CU SN	Level-3-245C-168 HR	-40 to 125	LP38856S 1.2	Samples
LP38856SX-1.2/NOPB	ACTIVE	DDPAK/ TO-263	KTT	5	500	Pb-Free (RoHS Exempt)	CU SN	Level-3-245C-168 HR	-40 to 125	LP38856S 1.2	Samples
LP38856T-1.2/NOPB	ACTIVE	TO-220	NDH	5	45	Green (RoHS & no Sb/Br)	CU SN	Level-1-NA-UNLIM	-40 to 125	LP38856T 1.2	Samples

(1) The marketing status values are defined as follows:

ACTIVE: Product device recommended for new designs.

LIFEBUY: TI has announced that the device will be discontinued, and a lifetime-buy period is in effect.

NRND: Not recommended for new designs. Device is in production to support existing customers, but TI does not recommend using this part in a new design.

PREVIEW: Device has been announced but is not in production. Samples may or may not be available.

OBSOLETE: TI has discontinued the production of the device.

(2) **RoHS:** TI defines "RoHS" to mean semiconductor products that are compliant with the current EU RoHS requirements for all 10 RoHS substances, including the requirement that RoHS substance do not exceed 0.1% by weight in homogeneous materials. Where designed to be soldered at high temperatures, "RoHS" products are suitable for use in specified lead-free processes. TI may reference these types of products as "Pb-Free".

RoHS Exempt: TI defines "RoHS Exempt" to mean products that contain lead but are compliant with EU RoHS pursuant to a specific EU RoHS exemption.

Green: TI defines "Green" to mean the content of Chlorine (Cl) and Bromine (Br) based flame retardants meet JS709B low halogen requirements of <=1000ppm threshold. Antimony trioxide based flame retardants must also meet the <=1000ppm threshold requirement.

(3) MSL, Peak Temp. - The Moisture Sensitivity Level rating according to the JEDEC industry standard classifications, and peak solder temperature.

(4) There may be additional marking, which relates to the logo, the lot trace code information, or the environmental category on the device.

(5) Multiple Device Markings will be inside parentheses. Only one Device Marking contained in parentheses and separated by a "-" will appear on a device. If a line is indented then it is a continuation of the previous line and the two combined represent the entire Device Marking for that device.

(6) Lead/Ball Finish - Orderable Devices may have multiple material finish options. Finish options are separated by a vertical ruled line. Lead/Ball Finish values may wrap to two lines if the finish value exceeds the maximum column width.

Important Information and Disclaimer: The information provided on this page represents TI's knowledge and belief as of the date that it is provided. TI bases its knowledge and belief on information provided by third parties, and makes no representation or warranty as to the accuracy of such information. Efforts are underway to better integrate information from third parties. TI has taken and continues to take reasonable steps to provide representative and accurate information but may not have conducted destructive testing or chemical analysis on incoming materials and chemicals. TI and TI suppliers consider certain information to be proprietary, and thus CAS numbers and other limited information may not be available for release.

In no event shall TI's liability arising out of such information exceed the total purchase price of the TI part(s) at issue in this document sold by TI to Customer on an annual basis.

TAPE AND REEL INFORMATION



QUADRANT ASSIGNMENTS FOR PIN 1 ORIENTATION IN TAPE



*All dimensions are nominal

Device	Package Type	Package Drawing	Pins	SPQ	Reel Diameter (mm)	Reel Width W1 (mm)	A0 (mm)	B0 (mm)	K0 (mm)	P1 (mm)	W (mm)	Pin1 Quadrant
LP38856SX-1.2/NOPB	DDPAK/ TO-263	KTT	5	500	330.0	24.4	10.75	14.85	5.0	16.0	24.0	Q2

TAPE AND REEL BOX DIMENSIONS



*All dimensions are nominal

Device	Package Type	Package Drawing	Pins	SPQ	Length (mm)	Width (mm)	Height (mm)
LP38856SX-1.2/NOPB	DDPAK/TO-263	KTT	5	500	367.0	367.0	45.0

NDH0005D



KTT0005B



TS5B (Rev D)

IMPORTANT NOTICE AND DISCLAIMER

TI PROVIDES TECHNICAL AND RELIABILITY DATA (INCLUDING DATASHEETS), DESIGN RESOURCES (INCLUDING REFERENCE DESIGNS), APPLICATION OR OTHER DESIGN ADVICE, WEB TOOLS, SAFETY INFORMATION, AND OTHER RESOURCES "AS IS" AND WITH ALL FAULTS, AND DISCLAIMS ALL WARRANTIES, EXPRESS AND IMPLIED, INCLUDING WITHOUT LIMITATION ANY IMPLIED WARRANTIES OF MERCHANTABILITY, FITNESS FOR A PARTICULAR PURPOSE OR NON-INFRINGEMENT OF THIRD PARTY INTELLECTUAL PROPERTY RIGHTS.

These resources are intended for skilled developers designing with TI products. You are solely responsible for (1) selecting the appropriate TI products for your application, (2) designing, validating and testing your application, and (3) ensuring your application meets applicable standards, and any other safety, security, or other requirements. These resources are subject to change without notice. TI grants you permission to use these resources only for development of an application that uses the TI products described in the resource. Other reproduction and display of these resources is prohibited. No license is granted to any other TI intellectual property right or to any third party intellectual property right. TI disclaims responsibility for, and you will fully indemnify TI and its representatives against, any claims, damages, costs, losses, and liabilities arising out of your use of these resources.

TI's products are provided subject to TI's Terms of Sale (www.ti.com/legal/termsofsale.html) or other applicable terms available either on ti.com or provided in conjunction with such TI products. TI's provision of these resources does not expand or otherwise alter TI's applicable warranties or warranty disclaimers for TI products.

Mailing Address: Texas Instruments, Post Office Box 655303, Dallas, Texas 75265
Copyright © 2019, Texas Instruments Incorporated

Looking for pricing, stock, or lifecycle information?

Click below to explore more details on WIN SOURCE:

 [View LP38856SX-0.8/NOPB on WIN SOURCE](#)

 [Texas Instruments](#) Information

Optimize Your Supply Chain with WIN SOURCE Solutions

-  Global Sourcing Solution
-  Obsolete Management
-  Cost Control Management
-  Shortage Management
-  Alternative Solution
-  Excess Inventory Management